

Model 2704 Controller

User Guide

HA026933 Issue 10

Date: June 2021



Eurotherm[®]

by **Schneider** Electric

Contents

- Contents 1
- Warning 13
- Battery Low Warning Message 13
- Battery Module 13
- Introduction 15
 - About this Manual 15
 - The Structure of this Manual 15
 - What is 2704 16
- Installation 18
 - Mechanical Installation 18
 - Positioning 18
 - Outline Dimensions Model 2704 18
 - Mounting the Controller 19
 - Unplugging and Plugging in the Controller 19
 - I/O Modules 20
 - To Add or Change Modules 21
 - Wiring 21
 - Electrical Connections 21
 - Rear Terminal Layout 22
 - Rear Terminals 23
 - Standard Connections 24
 - Power Supply Wiring 24
 - Relay Output 24
 - Sensor Input Connections 25
 - Analogue Input Connections 26
 - I/O Expander (or Additional Digital Input) 27
 - Digital I/O 28
 - Optional Plug in Module Connections 29
 - Digital Communications Connections 29
 - DeviceNet® Wiring 31
 - DeviceNet Terminal Functions 31
 - Wiring Interconnections for DeviceNet Communications 32
 - Ethernet Connections 33
 - I/O Modules 34
 - To Connect Zirconia (Dual Signal) Probe 39
 - Zirconia Probe Screening 40
 - Zirconia Carbon Probe Construction 40
 - Screening Connections When Two Modules are Used 40
 - Screening Connections When a Dual Input Module is Used 40
- Operation 41
 - Operator Interface - Overview 41
 - The Operator Buttons 42
 - Status Messages 43
 - Parameters and How To Access Them 44
 - Pages 44
 - Navigation Overview 45
 - To Select a Page Header 45
 - To Navigate to a Parameter from a Page Header 46
 - To Change Next Parameter in the List 47
 - To Change Any Parameter in the List 47
 - Backscroll 47
 - Parameter Values 48
 - Confirmation Mechanism 49
 - Invalid Key Actions 49

Parameter Tables 50

Parameter Availability and Alterability 51

Navigation Diagram..... 52

Function Blocks 55

 What is a Function Block?..... 55

 Inputs 55

 Outputs 55

 Settings 56

Soft Wiring 57

 What is Soft Wiring?..... 57

 An Example of Soft Wiring 58

 Configuration of the Simple PID Loop..... 59

 To connect the PV input to the Loop 59

 To connect the Loop to the Output Module 61

 To connect Digital Input DIO1 to Loop 1 Manual Input 62

Access Levels 63

 The Different Access Levels..... 63

 Passcodes..... 63

 To Enter Configuration Level..... 64

 To Enter New Passcodes 64

 To Exit Configuration Level 64

Instrument Configuration 65

 What is Instrument Configuration?..... 65

 To Select the Instrument Configuration Pages..... 65

 To Configure Controller Options..... 66

 Instrument Options Page 67

 Instrument Info Page..... 68

 Instrument Units Page 68

 Instrument Display Page..... 69

 Instrument Page Promote Page..... 71

 Instrument User Text Page 72

 Instrument Summary Page 73

 Summary Page Example 75

 Instrument Standby Page 75

 Example: To wire Standby to Fixed Digital Input 1..... 75

 User Text Examples 76

 To Re-Name Loop 1 to Zone 1..... 76

 Implementation 76

 To Re-Name User Alarm 1 and Provide a Message 76

 Implementation 76

 To Re-Name Module 1 to be called Heat Output 77

 Implementation 77

 To Rename a Digital Input and show in the Summary Page..... 77

 Implementation 77

 To Assign Custom Units 79

 Implementation 79

 To Customise the Power Up Display..... 79

 Implementation 79

Programmer Configuration 80

 What is Setpoint Programming? 81

 Synchronous Programmer 81

 Asynchronous Programmer 82

 Setpoint Programmer Definitions 83

 Run 83

 Hold..... 83

 Reset..... 83

 Servo..... 83

 Hot Start..... 83

Programmer Types..... 84
 Time To Target Programmer 84
 Ramp Rate Programmer 84
 Segment Types 84
 Profile 84
 Go Back To Segment 85
 End Segment 85
 Wait 86
 Power Fail Recovery 87
 Holdback (Guaranteed Soak)..... 88
 Program User Values 89
 Program User Value Enumerations 89
 External Program Inputs 90
 Profile Lock 90
 Example: To Configure a Synchronous Programmer..... 91
 Example: To Configure Synchronous Programmer Type 92
 Program Edit Options Page 92
 Programmer Wiring 94
 Programmer Function Block 94
 PROGRAM EDIT Wiring Page..... 95
 To Create or Edit a Program 96
 Example: To Access The Program Edit Pages..... 96
 Program Edit (Program Page) Parameters 97
 Fine and Coarse Holdback 97
 Example: To Set Up Each Segment of a Program 98
 Program Edit (Segment) Parameters..... 98
 To Run a Synchronous Program 100
 To Hold a Program 100
 To Reset a Program 100
 From Digital Inputs 100
 From Digital Communications 100
 From the PROGRAM RUN Page..... 100
 Example: To View The State of a Running Program 101
 Run Parameter Tables 101
 Programmer Wiring Examples 103
 One Profile, Three Loops 103
 Implementation 103
 Two Profiles, Two Loops 104
 Implementation 105
 Asynchronous Programmer 106
 Program Groups..... 107
 Example: To Configure an Asynchronous Programmer 108
 Example: To Configure Asynchronous Programmer Type 109
 Program Group Options Page 109
 Program Groups Wiring Page..... 110
 Program Groups Group Edit Page..... 110
 Profile Setpoint Pages..... 111
 PSP1 (2 or 3) Profile Options..... 111
 PSP1 (2 or 3) Profile Wiring..... 112
 PSP1 (2 OR 3) Profile Run General Pages 113
 PSP1 (2 OR 3) Profile Run Segment Pages..... 114
 PSP1 (2 OR 3) Profile Program Edit Parameters 114
 PSP1 (2 or 3) Profile Segment Parameters 115
 Example: To Set Up and Run Program Groups 117
 Example: To Copy a Program 118
 Example: To Insert a Segment Into a Program 119
 Programmer Error Messages..... 119
 Running an Asynchronous Programmer 119
 Example: To Run a Program Using The Prog Button..... 120
 Asynchronous Programmer Status Bar 121
Digital Programmer 122
 What is the Digital Programmer? 122

To Edit The Digital Programmer 123

 Digital Program Edit Page..... 123

 Digital Program 1 to 4 Page..... 124

Power Fail Recovery 124

Cascade Trim Mode – Earlier Controllers 125

 Cascade Parameters (prior to April 2001)..... 125

Alarm Operation 126

 Definition of Alarms and Events 126

 Customisable Parameter Names 126

Types of Alarm Used in 2704 Controller..... 127

 Full Scale High..... 127

 Full Scale Low..... 127

 Deviation High Alarm 128

 Deviation Low Alarm 128

 Deviation Band..... 129

 Rate Of Change Alarm (Negative Direction) 129

 Rate Of Change Alarm (Positive Direction)..... 130

Blocking Alarms..... 131

 Full Scale Low With Blocking..... 131

 Full Scale High Alarm With Blocking..... 131

 Deviation Band With Blocking..... 132

Latching Alarms..... 132

 Latched Alarm (Full Scale High) - Automatic 132

 Latched Alarm (Full Scale High) - Manual 133

 Grouped Alarms..... 133

How Alarms Are Indicated 134

 Alarm Delay Time..... 134

To Configure an Alarm..... 135

Alarm Tables 136

 Alarms (Summary Page)..... 137

 Alarms LP1 (2 or 3) Page Parameters..... 138

 Alarms (PV Input Page) Parameters..... 139

 Alarms (An Input Page) Parameters..... 139

 Alarms (Module 1,3, 4, 5 & 6 Page) Parameters 139

 Alarms (User 1 to 8 Page) Parameters..... 140

Alarm Wiring Examples..... 141

 Control Loop With High and Low Alarms 141

 Implementation 142

 Loop Alarm Inhibited if Programmer not in Run 143

 Implementation 144

Loop Set Up 145

 What is Loop Set Up 145

 Loop Set Up (Options Page)..... 146

Single Loop Control..... 150

 Loop Set Up (Wiring Page) Single Loop 150

Setpoint Definition 151

 Setpoint Function Block 151

 Setpoint Parameters 152

 LP1 Setup (SP Aux) Page..... 153

Pid Control 154

 Proportional Term..... 154

 Integral Term 154

 Derivative Term 155

 High and Low Cutback..... 155

 PID Block Diagram..... 156

 Remote (External) OP Feedback..... 156

 Analogue Value..... 156

Gain Scheduling..... 157

 To Configure Gain Scheduling 158

 PID Parameters 158

 PID (Aux) Parameters..... 160

Output Parameters	161
Table of Output Parameters	161
Motorised Valve Control	162
Motor Parameters	162
Diagnostics.....	163
Diagnostic Page.....	163
Display	164
Display Page.....	164
Cascade Control	165
Overview	165
Full Scale Cascade Mode	165
Trim Mode	166
Auto/Manual Operation in Cascade	166
Cascade Controller Block Diagrams	167
Loop Setup (Wiring Page) for Cascade Loop	168
Cascade Parameters	169
Cascade Wiring Example.....	170
Implementation	170
Ratio Control	171
Overview	171
Basic Ratio Control	171
Controller Configured for Ratio	172
Ratio Parameters	173
Ratio Wiring Example	174
Implementation	174
Override Control.....	175
Overview	175
Simple Override	175
Sensor Break Action	176
Sensor Break Type = Output (0)	176
Sensor Break Type = Hold (1).....	176
Issues with Sensor Break	176
Downscale	176
Upscale	176
Controller Configured For Override.....	178
Override Parameters.....	179
Override Wiring Example	180
Implementation	181
Loop2 Set Up	181
Loop3 Set Up	181
Tuning	182
What is Tuning	182
Automatic Tuning	183
One-shot Tuning	183
To Autotune Control Loop Lp1.....	184
Carbon Potential Control.....	185
Autotune Parameters	186
To View the State of Autotune	186
Manual Tuning.....	187
Setting The Cutback Values.....	187
Integral Action and Manual Reset	188
Valve Position Control.....	188
Tuning When Gain Scheduling is Used	189
Tuning Procedure.....	189
Cascade Tuning	190
To Tune a Full Scale Cascade Loop	191
To Tune a Trim Mode Cascade Loop	193
Tuning the Loop	194
Controller Applications	195
Zirconia - Carbon Potential Control.....	196
Temperature Control	196

Carbon Potential Control.....	196
Sooting Alarm.....	196
Automatic Probe Cleaning	196
Endothermic Gas Correction.....	196
Example of Carbon Potential Controller Connections.....	197
To View and Adjust Zirconia Parameters	198
Zirconia Parameters.....	198
Wiring Page	200
Zirconia Wiring Example	200
The Zirconia Function Block	200
Main Features	200
Configuration of a Carbon Potential Control Loop	201
Implementation	201
Probe Impedance.....	203
Humidity Control.....	204
Overview	204
Example Of Humidity Controller Connections.....	204
Temperature Control of an Environmental Chamber	205
Humidity Control of an Environmental Chamber.....	205
To View and Adjust Humidity Parameters	205
Humidity Options Parameters	206
Wiring Page	206
Humidity Wiring Example	207
The Humidity Function Block	207
Main Features	207
Configuration of a Humidity Control Loop	207
Implementation	208
Vacuum Controller.....	209
Vacuum Chamber Example	209
Vacuum Controller Functionality	211
Setpoints	211
Low Vacuum Gauge.....	211
High Vacuum Gauge.....	212
Gauge Linearisation.....	212
Roughing Pump Timeout	212
Leak Detection.....	212
Gauge Switchover.....	213
Wiring Connections	214
Switch On.....	215
Operation	216
To Access the Vacuum Controller Parameters.....	216
Parameter Tables	217
High Vacuum Parameter Tables.....	217
Low Vacuum Parameter Tables	217
Backing Vacuum Parameter Tables	218
Gauge Switching Parameter Tables.....	218
Setpoint Parameter Tables.....	218
Pump Control Parameter Tables.....	219
Leak Detect Parameter Tables.....	219
Vacuum Display Parameter Tables	220
Configuration Level	221
To Configure the Vacuum Summary as the HOME Page	221
To Customise the Vacuum Summary Page	222
Vacuum Function Block	223
Vacuum Controller Wiring Examples.....	224
Simple Temperature and Vacuum Control	224
Implementation	225
To Scale Vacuum Readout in Other Units.....	226
Implementation	227
Input Operators	228
What are Input Operators.....	228
Custom Linearisation	229

Compensation for Sensor Non-Linearities	230
To View and Adjust Input Operator Parameters	231
Input Operator Custom Linearisation Parameters	232
Thermocouple/Pyrometer Switching	232
Input Operators Switch Over Parameters	233
To Set Up Input Operators (Monitor)	234
Input Operator Monitor Parameters	234
BCD Input.....	235
Main Features	235
BCD Parameters.....	235
Input Operators Wiring Examples	236
Switch Over Loop With Custom Linearised Input	236
Implementation	236
Configuring the BCD Input to Select a Program	237
Implementation	237
Holdback Duration Timer	238
Implementation	239
Timer, Clock, Totaliser, Operation	240
What are Timer Blocks?	240
Timer Types.....	241
On Pulse Timer Mode	241
Off Delay Timer Mode	242
One Shot Timer Mode.....	243
Compressor or Minimum On Timer Mode.....	244
To View and Adjust Timer Parameters	245
Timer Parameters	245
The Clock.....	246
Clock Parameters	246
Time Based Alarms	247
Timer Alarm Parameters	247
Totalisers	248
Totaliser Parameters	249
Application Example.....	250
Compressor Timer	250
Implementation	250
Advanced Functions	251
Pattern Generator	251
Example: Programmer Event Outputs	251
To Configure the Pattern Generator.....	252
To Wire Pattern Generator Outputs to the IO Expander Inputs	252
Analogue Switches.....	253
To Set Up an Analogue Switch.....	253
User Values.....	254
To Access User Values	254
User Values Parameter Table	255
User Messages	256
To Configure a User Message	257
User Switches	258
To Configure User Switches.....	258
Custom Enumerations.....	259
To Configure Custom Enumerations	259
User Switch Example.....	260
Programmer User Values Example.....	261
Enumerated User Value Example.....	261
User Pages	262
What Are User Pages.....	262
User Page Styles	262
Single Loop User Page	263
Dual Loop User Page.....	263
Triple Loop User Page – Style 1	264

Triple Loop User Page – Style 2	264
Status Grid User Page	265
Bar Graph	266
Parameter List Style.....	266
To Configure a User Page.....	267
To Display the User Page View.....	269
Auto Manual Operation From a User Page.....	269
User Page Parameter Tables	270
Single Loop	270
Dual Loop.....	271
Triple Loop 1 and 2	272
Status Grid	273
Bar Graph	274
Parameter List.....	275
Blank Page.....	275
Analogue And Multiple Operators	276
What are Analogue Operators?.....	276
Analogue Operations	277
To Configure Analogue Operators.....	278
Analogue Operator Parameters	278
Multiple Operators.....	279
Cascading Multiple Input Blocks	279
To Enable Multi Operators.....	281
To Locate Multi Operator Parameters	281
Multi Operator MultiOp1 (to 3) Page	281
Use of Default	282
Logic Operators	283
Logic Operations.....	283
To Configure Logic Operators	284
Logic Operator Parameters.....	284
Patch Wiring.....	285
Patch Wiring Parameters	285
Digital Communications	286
What is Digital Communications?	286
To Configure Communications Parameters	287
H Module Parameters	288
Ethernet Parameters.....	289
J Module Parameters	289
Digital Communications Diagnostics.....	290
Ethernet Technical Note	291
MAC address display	291
DHCP Settings.....	291
Instrument setup	291
Network Connection.....	291
Dynamic IP Addressing.....	292
Fixed IP Addressing	292
Additional Notes.....	292
iTools Setup	292
Addendum: 2704 Controller Specials Number Eu0678	293
2704 Master Communications	294
Introduction	294
Broadcast Communications	294
Direct read/write.....	294
Wiring Connections.....	295
Example Wiring Diagrams for Different Slaves.....	296
Cross-Board Version	298
Basic Navigation	298
To Configure Parameters	299
To Configure Slaves.....	300

Parameter Tables	301
Additional Notes	302
IEEE in 2000 Series	302
Configuration Mode	303
Standard IO	304
What is Standard IO?	304
PV Input	305
To Scale the PV Input	305
Offset	306
To View and Change Input Filter Time	307
Standard IO PV Input Parameters	307
Analogue Input	309
To Scale the Analogue Input	309
Standard IO Analogue Input Parameters	309
Sensor Break Value	310
Fixed Relay Output	310
To Scale The Fixed Relay Output	310
The Fixed Relay Output Parameters	313
Standard IO AA Relay Parameters	313
Standard IO Dig I/O Parameters	314
Standard Digital IO Parameters	314
Standard IO Diagnostic Parameters	315
Standard IO Diagnostic Parameters Table	315
Module IO	316
What is Module IO?	316
Module Identification	317
Idents Page	318
Module IO Parameters	319
DC Control and DC Retransmission	319
Relay Output	320
Triac Output	321
Triple Logic Output and Single Isolated Logic Output	322
Triple Logic and Triple Contact Input	323
Transmitter Power Supply	323
Transducer Power Supply	323
Potentiometer Input	324
PV Input	324
DC Input	326
Dual PV Input	327
4-Wire RTD Input	329
Dual DC Output	330
Dual DC Output Module IO Parameters	331
High Resolution Retransmission Output	332
High Resolution Output Module Parameters	336
TDS Input Module	337
TDS Input Module Parameters	337
Cable Offset	338
To Calibrate Cable Offset	338
Module Scaling	339
The PV Input	339
To Scale The PV Input	340
Output Modules	341
To Scale a Control Output	342
Retransmission Output	342
To Scale a Retransmission Output	343
To Scale the Potentiometer Input	344
Module IO Wiring Examples	346
To Configure Module 1 Channel A to Run a Program	346
Implementation	346
To Operate a Relay from a Digital Input	346
Implementation	346

Zirconia Probe Impedance Measurement.....	347
Implementation	348
Calibration.....	348
Transducer Scaling	349
What is Transducer Scaling?	349
Shunt Calibration.....	350
To Calibrate a Strain Gauge Bridge Transducer	351
Load Cell Calibration.....	352
To Calibrate a Load Cell.....	353
Comparison Calibration.....	353
To Calibrate a Controller Against a Second Reference.....	354
Auto-Tare Calibration	355
To Use the Auto-Tare Feature	355
Transducer Scaling Parameters.....	357
Transducer Scaling Parameter Table.....	357
Parameter Notes.....	358
IO Expander	359
What is IO Expander?	359
To Configure IO Expander	360
Instrument Options Page	360
Diagnostics	361
What are Diagnostics?	361
Diagnostics Parameters.....	361
Calibration	363
User Calibration	363
Precautions	363
PV Input	364
To Calibrate mV Range.....	364
Thermocouple Calibration.....	366
Voltage Calibration	366
High Z Voltage Calibration	366
3-Wire RTD Calibration.....	367
Analogue Input.....	368
Module I/O.....	370
DC Output Module	370
PV Input Module	371
Dual PV Input Module	372
DC Input Module.....	372
TDS Input Module – Conductance Calibration.....	372
4-Wire RTD Module Calibration	373
Main Features.....	373
Cable Connection Errors	375
Maximum Resistance of Outer Wires	375
Detaching RTD Sensor with Instrument Powered ON.....	375
To Restore Factory Calibration Values.....	376
Boiler Control	377
Introduction	377
What is TDS?.....	378
How is TDS Measured?	378
‘Specific Conductance’.....	378
Temperature Correction Factor – TCF25(TLiquid).....	378
Probe Factor (K)	379
Probe Design and TDS Module Operation	379
Probe Deterioration.....	380
Driver O/P	381
Bubbles.....	381
TDS Function Block	382
Installation versus Operation Modes.....	382

Probe Deterioration / Scaling	382
TDS Function Block Parameters.....	383
Further Parameter Descriptions.....	385
TDS Status Values.....	385
‘Temp Coef’, ‘K-Factor’ and ‘Use Table’ Parameters.....	385
‘Set-up’ Parameter.....	386
TDS Calibration	386
ProbeCal.....	387
TDSscal.....	387
TCF Cal	387
TDS Calibration Using Cal State Parameter.....	388
Function Block Status Enumerations.....	389
Bottom Blowdown Function Block.....	390
Bottom Blowdown of Multiple Boilers.....	390
Operating Principles of High Integrity Interlock Bus.....	391
Blowdown Sequence	392
Non High Integrity Interlock Bus	392
Valve Switch Option	392
Bottom Blowdown Parameters.....	393
Example: To Perform a Boiler Blowdown.....	394
TDS Input Module	394
Configuration Using Itools	395
Programmer Editor.....	395
Introduction	395
Number of Programs.....	395
Online / Offline Editing	395
Graph Printing.....	396
Program Printing	396
Opening the Editor	396
PSP Parameters	397
Hidden Parameters	397
PSP Wiring.....	397
Program Parameters.....	398
Program and PSP Names.....	398
Segment Parameters	399
The Graph.....	399
Programmer Toolbar	399
Programmer Menu	399
Adding, Inserting and Deleting Segments.....	399
Segment Type.....	401
The Graph.....	406
Digital Graphs	407
Asynchronous Programmer	408
Entry to Asynchronous Mode	408
Using the Editor in Asynchronous Mode	409
Differences between Synchronous and Asynchronous.....	409
User Page Editor.....	411
2704 User Page Editor.....	411
Promote Parameters.....	414
User List Tab	414
Styles	415
Go to Menu Control Button	429
Appendix A Order Code	430
Hardware Code.....	430
Quick Start Code.....	432
Quick Start Code Example:.....	432
Appendix B Safety And EMC Information	433
Safety	433
Electromagnetic Compatibility.....	433
General	433

Service and Repair.....	433
Electrostatic Discharge Precautions	434
Cleaning.....	434
Installation Safety Requirements	435
Safety Symbols	435
Personnel.....	435
Enclosure of Live Parts	435
Isolation.....	435
Wiring.....	436
Power Isolation	436
Earth Leakage Current.....	436
Overcurrent Protection.....	436
Voltage Rating.....	436
Conductive Pollution	437
Over-Temperature Protection.....	437
Grounding of the Temperature Sensor Shield.....	437
Installation Requirements For EMC	438
Routing of Wires	438
Appendix C Technical Specification	439
All Analogue, Dual And Pv Inputs.....	439
Precision PV Input / Module.....	439
Dual (Probe) Input Module	440
Analogue Input.....	440
Analogue Input Module	440
Standard Digital I/O.....	441
Digital Input Modules.....	441
Digital Output Modules.....	441
Analogue Output Modules.....	441
Transmitter PSU.....	442
Transducer PSU.....	442
Dual DC Output.....	442
High Resolution DC Output.....	442
Potentiometer Input.....	442
TDS Module	442
4-Wire RTD Input	443
Digital Communications	443
Alarms	444
User Messages	444
Control Functions	444
Setpoint Programmer	444
Advanced Functions.....	444
General Specification.....	445
Graphical Representation of Errors.....	446
mV Input.....	446
Mid range high impedance Input.....	447
High Level Input.....	447
3-Wire RTD (Pt-100) Input type	448
Thermocouple Input type	448
Appendix D Parameter Units and Addresses	449
Commonly Used Parameters	449
Parameter Units	454
Module Status Messages.....	454

Warning

Back up Battery

This instrument is fitted with a battery designed to retain configuration and other settings in the event of a failure of the instrument power supply.

This battery has an expected life of 10 years minimum at a nominal ambient working temperature (e.g. 25°C).

The battery life may be reduced if it is consistently operated in an elevated ambient temperature environment.

Maintenance Schedule

On earlier instruments, generally manufactured before January 2014, a battery failure is only evident following a failure of the instrument power supply.

It is, therefore, recommended that the battery is replaced at regular intervals depending on usage and operating temperature.

The battery is not user serviceable.

Please contact your supplier at the earliest opportunity to arrange for the battery to be replaced prior to its failure.

The age of the instrument is shown on the side label. This contains a serial number, where the last four characters either show the week number and year of manufacture WW YY, or a date in the format UK YYWW.

It is important to maintain a record of instrument configurations or use Eurotherm iTools to make clone copies of fully working instruments. Store this securely as a back up to be used to restore the configuration.

Instrument cloning is described in the iTools Help Manual HA028838 which may be downloaded from www.eurotherm.co.uk.

Battery Low Warning Message

Instruments fitted with firmware versions 6.60 (and above) contain a low battery warning message. If the battery is low the message appears in the format shown below when the instrument is powered up.

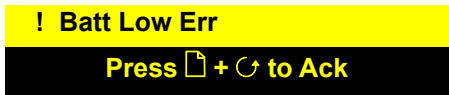

The message may be acknowledged by pressing the Page and Scroll buttons together and follow the instructions on the display, but it will re-appear every 24 hours (approximately) after that.

It is essential that the battery is changed as instructed in the warning shown above.

The low battery state is also shown in the Diagnostics page of the instrument, section Diagnostics.

Battery Module

In addition to the low battery warning, instruments generally manufactured after Jan 2014 are fitted with a battery module. These instruments can be identified from the Status Level printed on the label fitted to the side of the instrument case. The Status Level is shown as two alpha-numeric characters.

Instruments fitted with a battery module have a firmware code of B (and above) and a hardware code of 3 (and above).

Instruments fitted with a battery module should also be returned to your service department for the battery to be changed.



Related Handbooks

The following related handbooks may be downloaded from the Eurotherm web site www.eurotherm.com/

2704 User Guide (shipped with the controller) Part No. HA029465.	Describes Installation and general operation
Series 2000 Communication Handbook Part No. HA026230	Describes EI-BiSynch and Modbus digital communications
Series 2000 Profibus-DP Communications Handbook Part No. HA026290	Describes Profibus digital communications
Series 2000 DeviceNet [®] Handbook Part No HA027506	Describes DeviceNet [®] digital communications

Handbook Supplements

2704CP Furnace Atmosphere Controller Supplement Part No. HA027734	Describes 2704 controller configured for carbon, dewpoint and oxygen control using Zirconia probes
2704VC Vacuum Furnace Controller Supplement Part No. HA027655	Describes 2704 controller configured for temperature and vacuum control of vacuum furnaces
2704MP Melt Pressure Controller Supplement Part No. HA027519	Describes 2704 controller configured for measurement and control of melt pressure in extruders
OEM Security Supplement Part No. HA027482	Describes the orderable option which allows an OEM to develop and install machine specific strategies
Boiler Controller Part No. HA028177	Specific clone file description

Introduction

Thank you for selecting the 2704 High Performance Programmer/Controller. This chapter provides a general overview of your controller to help you to become more familiar with its use, and to ensure that it is the correct type for your process.

About this Manual

This manual is intended for those who wish to install, commission and configure the controller.

An Installation and Operation sheet is supplied with the controller part number HA029465.

Access to the parameters in the controller is achieved through five configurable levels of security:

Level 1	Operation only. This level allows, for example, parameters to be changed within safe limits or programmers to be run, held or reset.
Level 2	Supervisory level. This level allows, for example, parameter limits to be pre-set or programs to be edited or created. (Default Passcode = 2)
Level 3	Commissioning level. This level is intended for use when commissioning the instrument. It allows, for example, calibration offsets to be adjusted to match transducer and transmitter characteristics. (Default Passcode = 3)
View Configuration	It is possible also to read the configuration of the controller at any level but the configuration cannot be changed. (Passcode = 2704)
Configuration	Configuration of the controller allows you to set up the fundamental characteristics of the controller so that it can be made to match the requirements of the process. (Default Passcode = 4)

The Structure of this Manual

This chapter provides a general overview of the controller.

Installation describes installation and wiring.

Operation describes general operation in Operator levels.

Remaining chapters are associated with configuring the controller to specific applications and provide parameter tables with explanations of their meanings.

These chapters follow the order in which the features appear in the controller and the navigation diagram in section Navigation Overview.

What is 2704

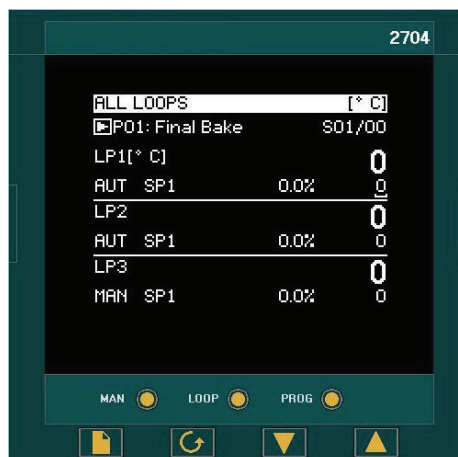

Figure 1 General View of 2704 Controller Display

The 2704 is a modular, fully configurable, high accuracy, high stability temperature and process controller which is available in a single, dual or three loop format.

It is supplied in accordance with an ordering code which can be found printed on a label on the side of the instrument case. A description of the order code is given in Appendix A of this guide and should be checked with that shown on the label.

A 120 x 160 pixel electroluminescent is used to show all process information. The user interface is menu driven via the display and seven front panel keys.

Figure 1 shows an example of this display when the instrument has been configured as a three loop controller.

Features include:

- Advanced ramp/dwell programmer with storage of up to 50 programs.
- Application specific controllers such as Carbon Potential, Humidity and Melt Pressure.
- A wide variety of inputs which can be configured, including thermocouples, Pt100 resistance thermometers and high level process inputs.
- Each loop can be defined to be PID, On/Off or motorised valve position and can control using a variety of strategies including single, cascade, override and ratio control.
- PID control outputs can be relay, logic, triac or dc with motorised valve position outputs being relay triac or logic.
- Auto tuning and PID gain scheduling are available to simplify commissioning and optimise the process.

Configuration of the controller is explained in this Manual. Configuration is achieved either via the front panel operator interface or by using 'iTools' - a configuration package which runs under the Windows operating system.

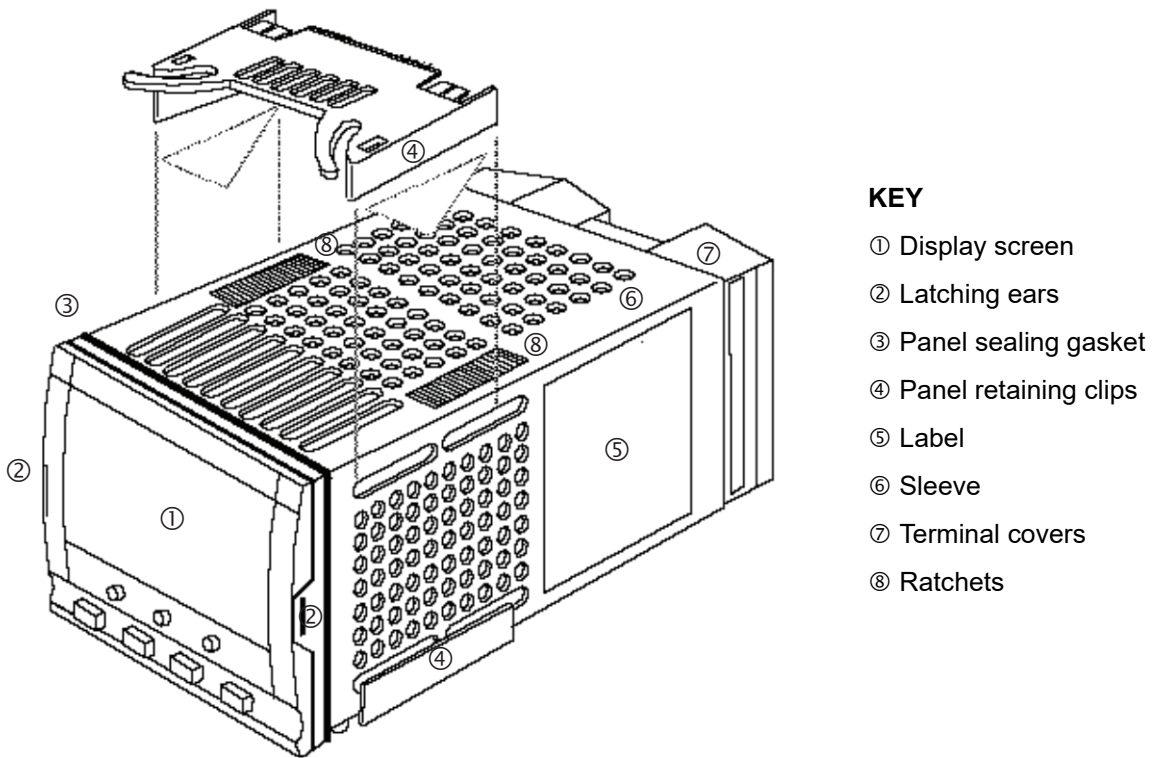

Figure 2 General View of 2704 Controller

Installation

The 2704 controller must be mounted and wired in accordance with the instructions given in this chapter and in the Installation sheet, Part No. HA029465 which is supplied with the controller.

The controller is intended to be mounted through a cut out in the front panel of an electrical control cabinet. Select a location where the minimum vibrations are present and the ambient temperature is within 0 and 50°C (32 and 122°F). The controller is retained in position using the panel mounting clips supplied.

All wires are connected to terminals at the rear of the instrument. Each block of six terminals is protected by a hinged cover which clicks into closed position.

Before proceeding please read Appendix B 'Safety and EMC Information'.

Mechanical Installation

Positioning

The controller can be mounted vertically or on a sloping panel of maximum thickness 15mm (0.6in). Adequate access space must be available at the rear of the instrument panel for wiring and servicing purposes. The outline dimensions are shown in below.

Take care not to cover ventilation holes in the top, bottom and sides of the instrument.

Outline Dimensions Model 2704

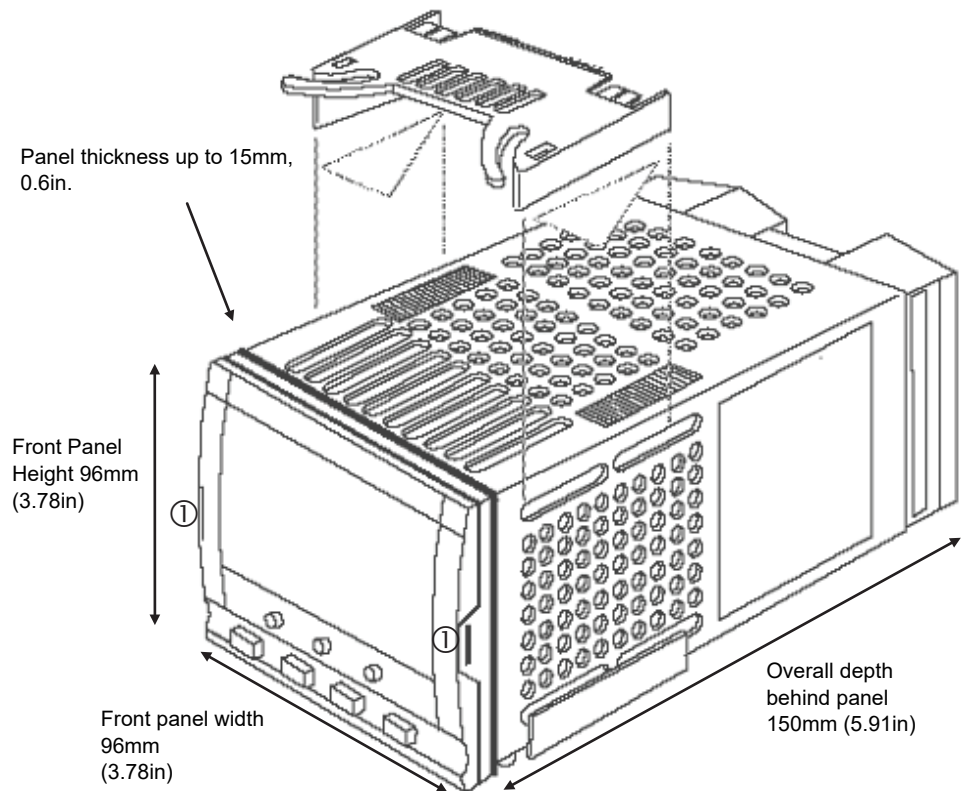

Figure 3 Outline Dimensions

Mounting the Controller

1. Prepare the panel cut-out to the size shown in Figure 4. Ensure that there is sufficient spacing between instruments as shown by the minimum dimensions given in Figure 4. Ensure also that the controller is not mounted close to any device which is likely to produce a significant amount of heat which may affect the performance of the controller.
2. Insert the controller through the panel cut-out.
3. Spring the upper and lower panel retaining clips into place. Secure the controller in position by holding it level and pushing both retaining clips forward.
4. Peel off the protective cover from the display.

Note: If the retaining clips subsequently need removing, in order to extract the controller from the control panel, they can be unhooked from the side with either your fingers or a screwdriver.

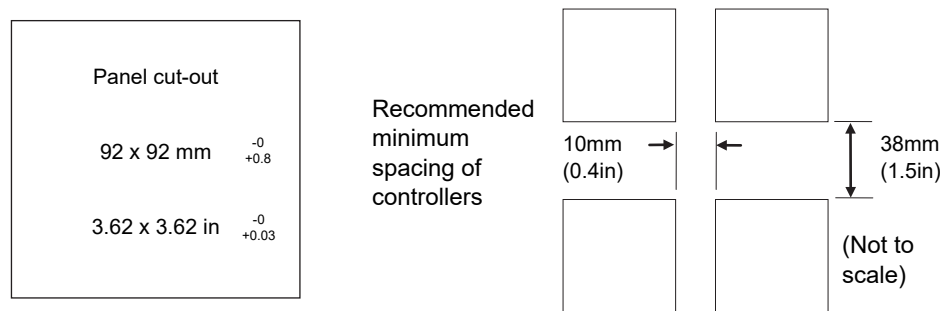

Figure 4 Panel Cut-out and Minimum Spacing Requirements

Unplugging and Plugging in the Controller

If required, the controller can be unplugged from its sleeve by easing the latching ears outwards and pulling the controller forward out of the sleeve. When plugging the controller back into its sleeve, ensure that the latching ears click into place.

It is recommended that the power to the controller is switched off when un-plugging or plugging the controller into its sleeve. This is to prevent premature wear on the controller connectors when current is flowing through them.

I/O Modules

The 2704 controller has the facility to fit optional plug in modules. The connections for these modules are made to the inner three connector blocks as shown in Figure 5.

The modules are:

- Communications modules.
- I/O modules

A list of available modules is given in Table 91.

These modules are fitted simply by sliding them into the relevant position as shown below.

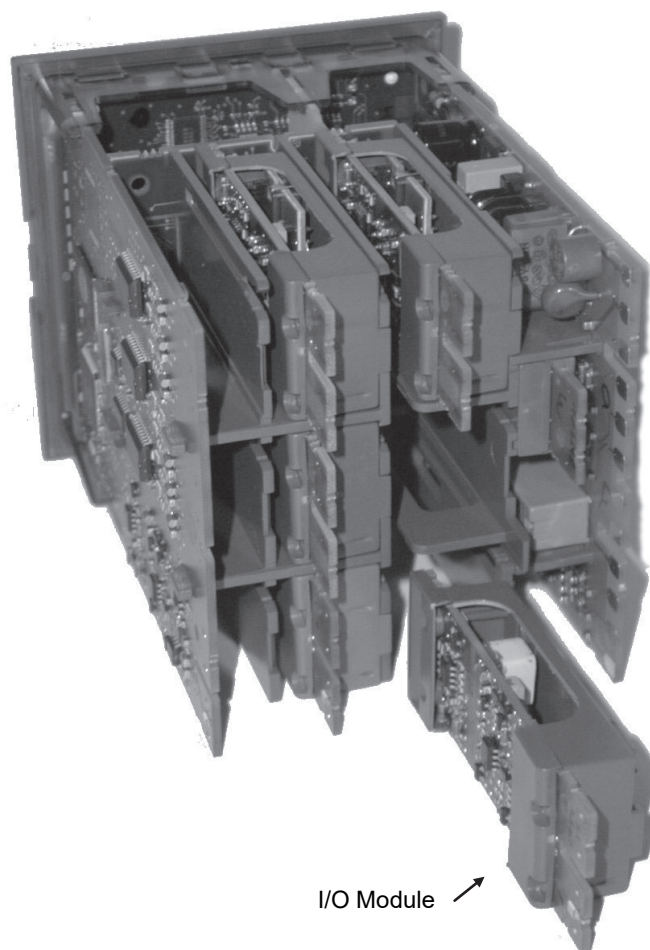

Figure 5 View of the Plug-in Modules

To Add or Change Modules



Should it be necessary to add, remove or change the position of modules follow the procedure below:

⚠ WARNING

SWITCH OFF POWER TO THE INSTRUMENT.

Remove the controller from its sleeve by pushing both latching ears ① (Figure 3) outwards, then ease the controller forwards from its sleeve. It should not be necessary to use any tools for this.

Allow at least 2 minutes for capacitors to discharge before commencing any work on the controller.

1. To remove a module it may be gripped by the rear terminals and pulled out from its location.
2. To fit a new module gently insert it into the required location ensuring that the raised section on the plastic cover of the module slides into the slot in the retaining housing.
3. Slide the controller back into its sleeve and turn power back on.
4. After a brief initialisation period, the message **!Module Changed** will appear on the display.
5. Press  and  together, as instructed, to acknowledge.
6. If the message **Bad Ident** is displayed this indicates that the wrong type of module has been installed, for example an unisolated logic output module from 2400 series.

Wiring

⚠ WARNING

You must ensure that the controller is correctly configured for your application. Incorrect configuration could result in damage to the process being controlled, and/or personal injury. It is your responsibility, as the installer, to ensure that the configuration is correct. The controller may either have been configured when ordered, or may need configuring now.

Before proceeding further, please read Appendix B, Safety and EMC information.

Electrical Connections

All electrical connections are made to the screw terminals at the rear of the controller. They accept wire sizes from 0.5 to 1.5 mm² (16 to 22 AWG) and should be tightened to a torque of 0.4Nm (3.5lbin). If you wish to use crimp connectors, the correct size is AMP part number 349262-1. The terminals are protected by a clear plastic hinged cover to prevent hands, or metal, making accidental contact with live wires.

Rear Terminal Layout

The rear terminal layout is shown in Figure 6, which identifies terminal designations and their functions. Refer to the individual diagrams to wire the controller to your requirements.

The two outer terminal strips have fixed hardware for all versions of the instrument, as follows:-

- A Process Variable input which can be configured for:
 - Thermocouple, RTD, Pyrometer, Voltage (e.g. 0-10Vdc) or Milliamp (e.g. 4-20mA) plus vacuum – log10
- Seven Digital I/O, configurable as input or output
 - Inputs are logic (-1 to 35Vdc) or contact closure, and can be configured for:- Manual, Remote, Run, Hold, Reset, etc.
 - Outputs are open collector requiring an external power supply, and can be configured as event, status time proportioning or valve position outputs.
- One digital input
- An I/O expander which allows additional digital I/O via an external unit, or an extra digital input
- A changeover relay which can be configured as an alarm or event output. It cannot be configured as a time proportioning output
- An analogue input for volts (e.g. 0-10Vdc) or Milliamp (e.g. 4-20mA) signals to a second PID loop, setpoint, etc,. (This input can be characterised to match a particular curve from a transmitter. It cannot accept thermocouple inputs directly)
- Power supply to the unit. The supply may be 85 - 264Vac 50 or 60 Hz, The three central terminal strips are for optional plug in modules, as follows:
 - Terminals marked 2A to 2D are reserved for a Memory Module only. No connections should be made to these terminals
 - Terminals marked HA to HF are connections for optional EIA232, EIA485, or EIA422 communications modules
 - Terminals marked JA to JF are connections for an optional slave communications module or second communications port used to communicate with other instruments

The modules fitted into the above two communications slots can be inter-changed

For a full list of available modules refer to the Ordering code - Appendix A and the Technical Specification - Appendix C.

WARNING

Take care that mains supplies are connected only to the power supply terminals (100 to 240Vac only), the fixed relay terminals or to relay or triac modules. Under no circumstances should mains supplies be connected to any other terminals.

Rear Terminals

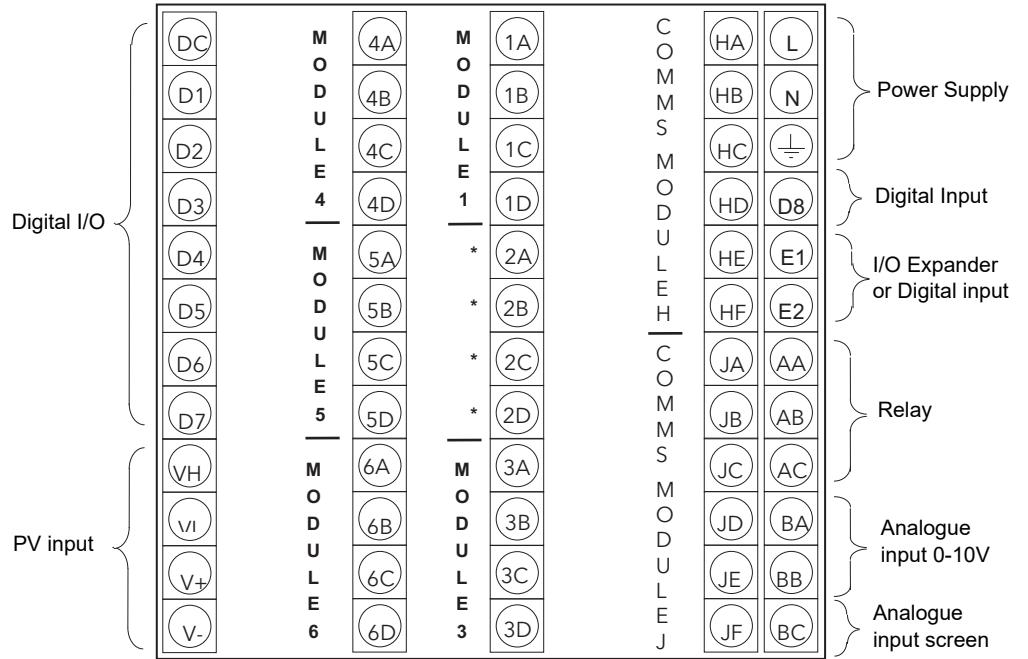

Note: I/O Expander is not supported beyond products with a product status level (PSL) equal to 'B5' and above. The status level is specified on the serial number which can be found on the label fitted to the side of the controller - Serial No: PL2107001772-072- S9 ('S' denotes the software status and changes alphabetically and '9' denotes hardware status and increments).

The functionality of the two outer rows of terminals is common to all instrument variants, as follows:

PV input	VH, VI, V+, V-
Analogue input	BA, BB
I/O expander	E1, E2
Fixed changeover relay	AA, AB, AC
Digital I/O channels	D1 to D8 and DC
Power supply	L, N, Earth

* Terminals 2A, 2B, 2C, 2D must not be wired to.

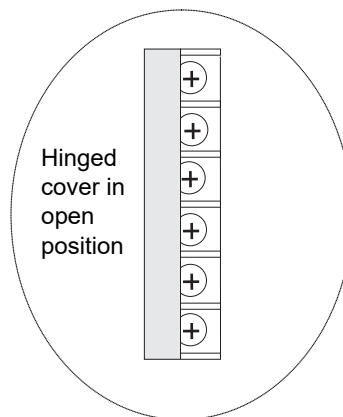

Figure 6 Rear Terminal Connections

Standard Connections

Power Supply Wiring

Controllers supplied with the VH Supply Voltage option are suitable for connection to a power supply of between 100 and 230Vac, +15%, 48 to 62 Hz.

Controllers supplied with the VL Supply Voltage option are suitable for connection to a power supply of

24Vac -15%, +10%, 48 to 62Hz or 24Vdc -15%, +20%.

It is the users responsibility to provide an external fuse or circuit breaker. Suitable fuses are:

For 100 to 230 volt supply Fuse type T (EN60127 time-lag type) rated at 1A, 250V
 24 volt supply Fuse type T (EN60127 time-lag type) rated at 4A, 250V

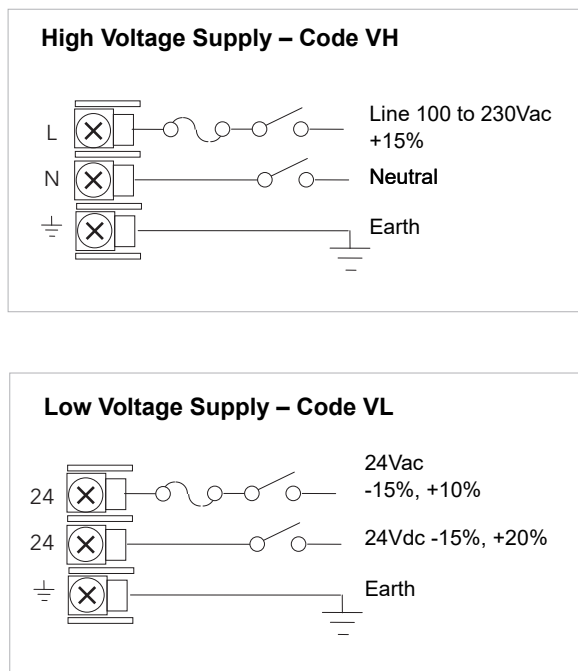

Figure 7 Supply Voltage Connections

Relay Output

A single changeover relay is provided as standard. It can be configured as a control output or an alarm or event output.

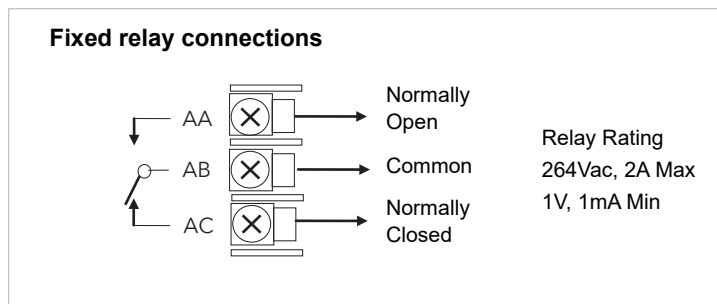
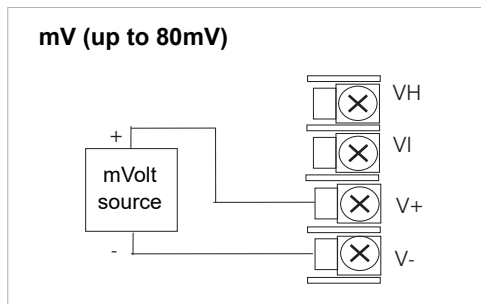
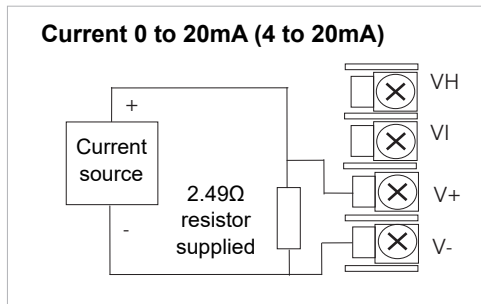
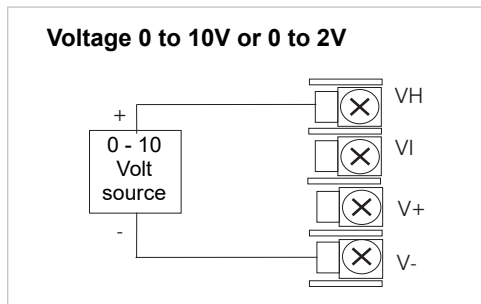
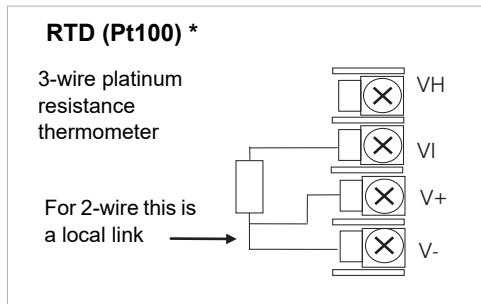
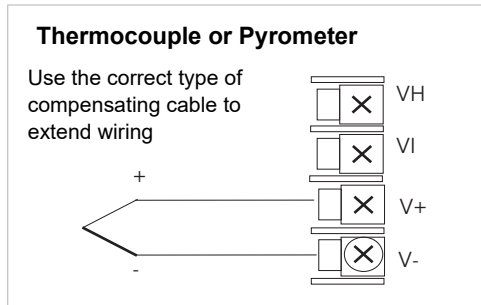

Figure 8 Wiring Connections For Fixed Relay Output

Sensor Input Connections

The fixed PV input can accept a range of sensors including Thermocouple, RTD (Pt100), Pyrometer, Voltage (e.g. 0-10Vdc) or Milliamp (e.g. 4-20mA) signals. These sensors are used to provide inputs to Control Loop 1.



***Note:** This connection is shown for 26 and 2700 series controllers. It is not the same as 2400 and 2200 series controllers.

Figure 9 Wiring Connections For PV Input

Analogue Input Connections

The analogue input is supplied as standard and is intended to accept 0 to 10 Vdc from a voltage source. A milli-amp current source can be used by connecting a 100Ω resistor across terminals BA and BB. This input can be used as a remote setpoint input, remote setpoint trim or as a high level PV input to a control loop. This input is not isolated from the digital IO.

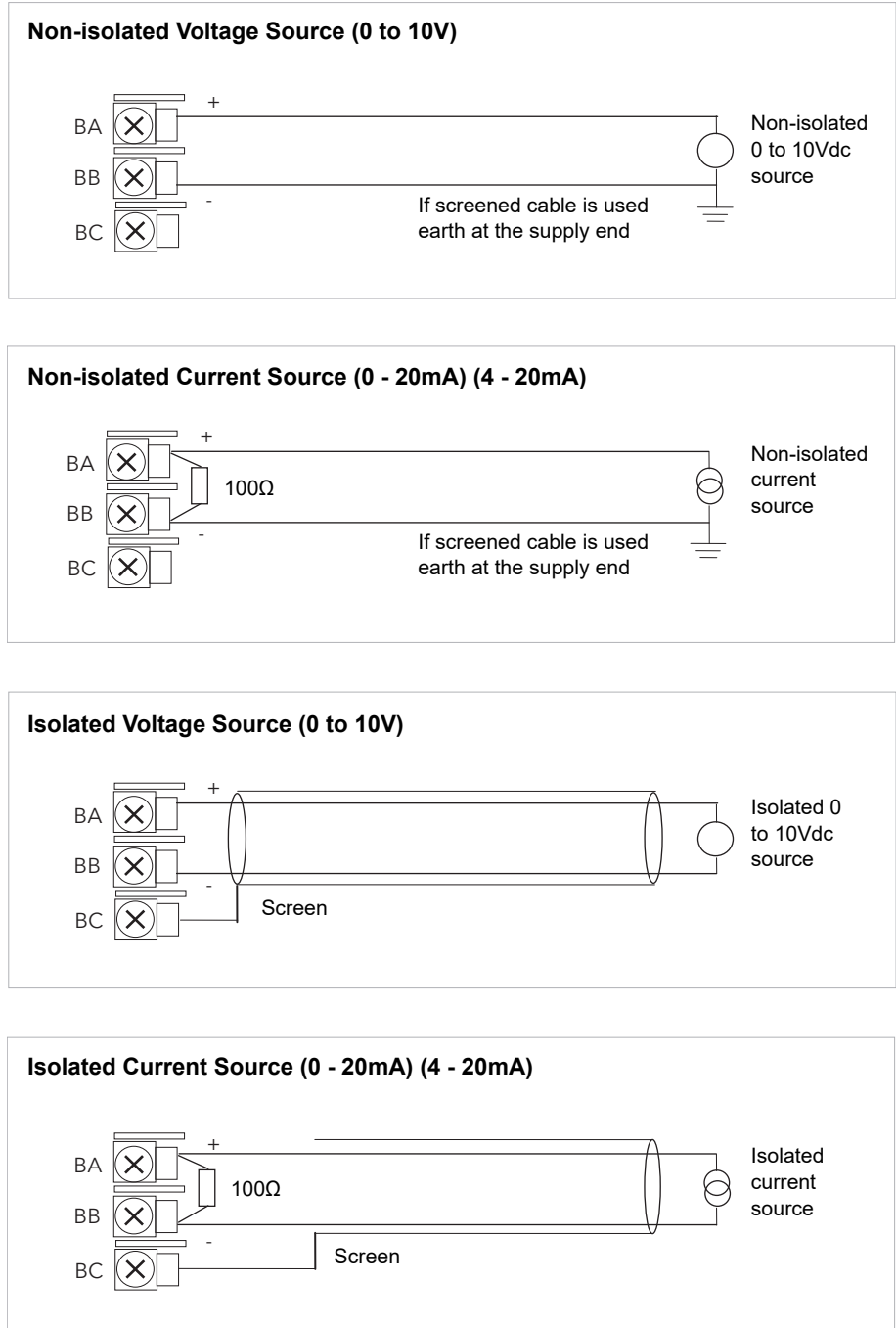

Figure 10 Wiring Connections For Analogue Input

I/O Expander (or Additional Digital Input)

Note: I/O Expander is not supported beyond products with a product status level (PSL) equal to 'B5' and above. The status level is specified on the serial number which can be found on the label fitted to the side of the controller - Serial No: PL2107001772-072- S9 ('S' denotes the software status and changes alphabetically and '9' denotes hardware status and increments).

An I/O expander (Model No 2000IO) can be used with the 2704 to allow the number of I/O points to be increased by a further 20 digital inputs and 20 digital outputs. Data transfer is performed serially via a two wire interface from instrument to expander.

If the expander unit is not required it is possible to use terminals E1 & E2 as a secondary digital input. These terminals are not part of the digital I/O terminals D1 to D8 and if used in this way connect a 2K2, ¼ W limiting resistor in series with the input, see Figure 11.

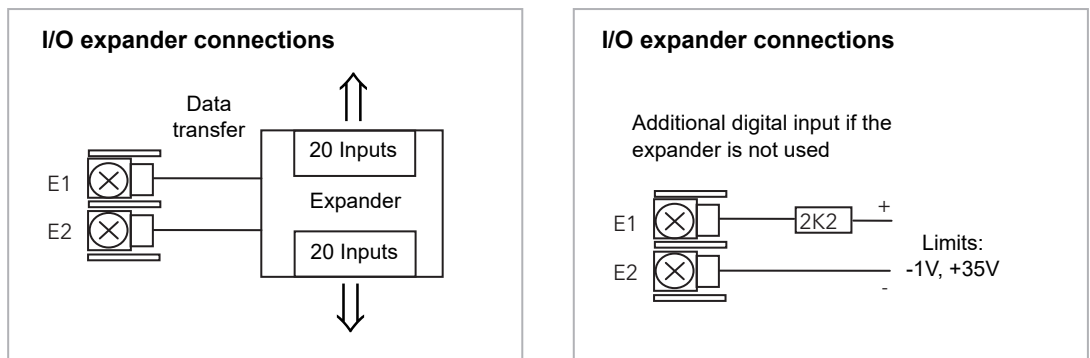

Figure 11 Wiring Connections for the I/O Expander

For details of the IO Expander refer to the Operating Instructions HA026893. The connections for this unit are reproduced below for convenience.

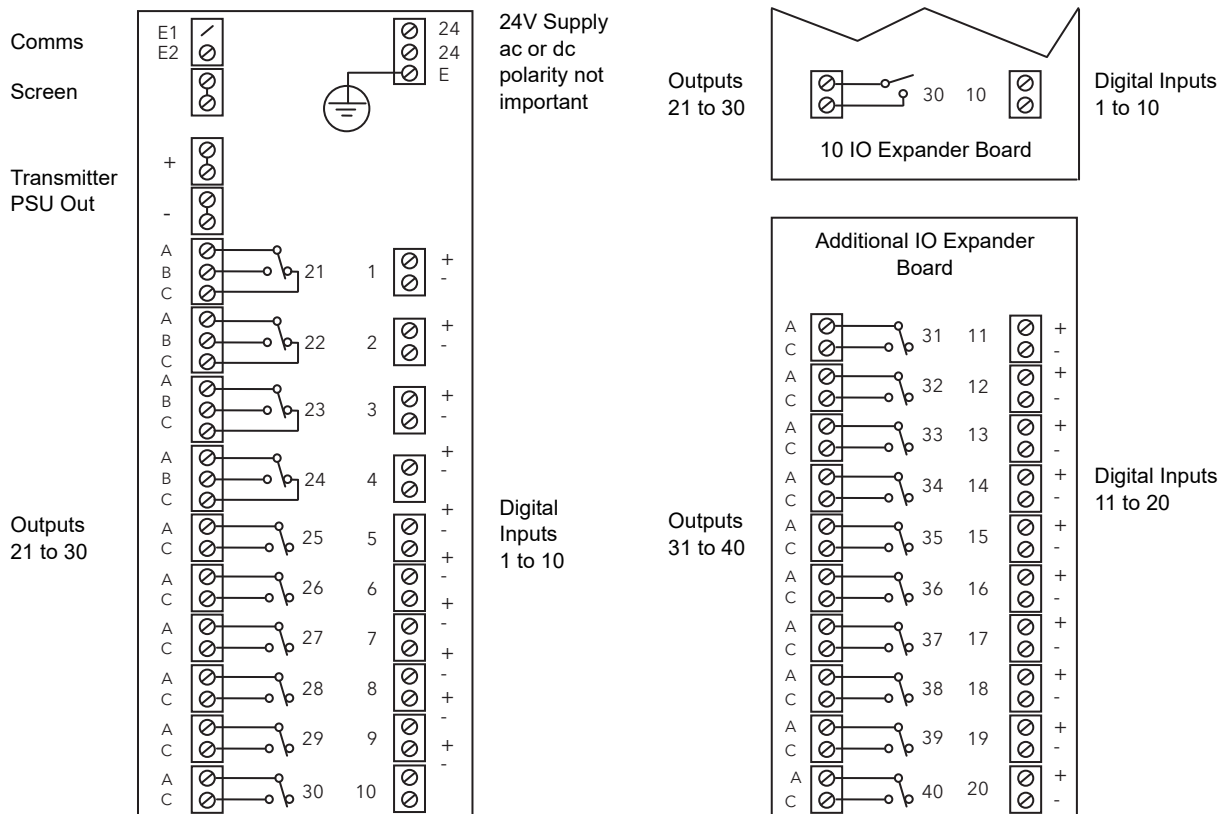

Figure 12 IO Expander Connections

Digital I/O

Eight digital I/O connections are provided as standard. They can be individually configured as:

1. Inputs Run, Hold, Reset, Auto/Manual, etc. - logic or contact closure.
2. Outputs Configurable as Control outputs, Programmer Events, Alarms, etc.

Digital IO is not isolated from instrument ground.

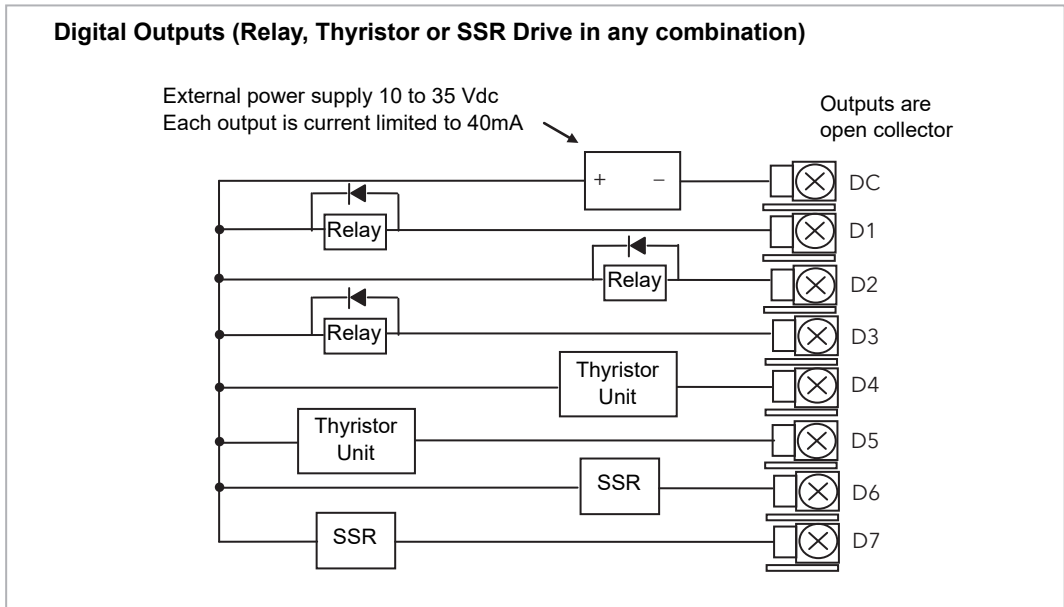
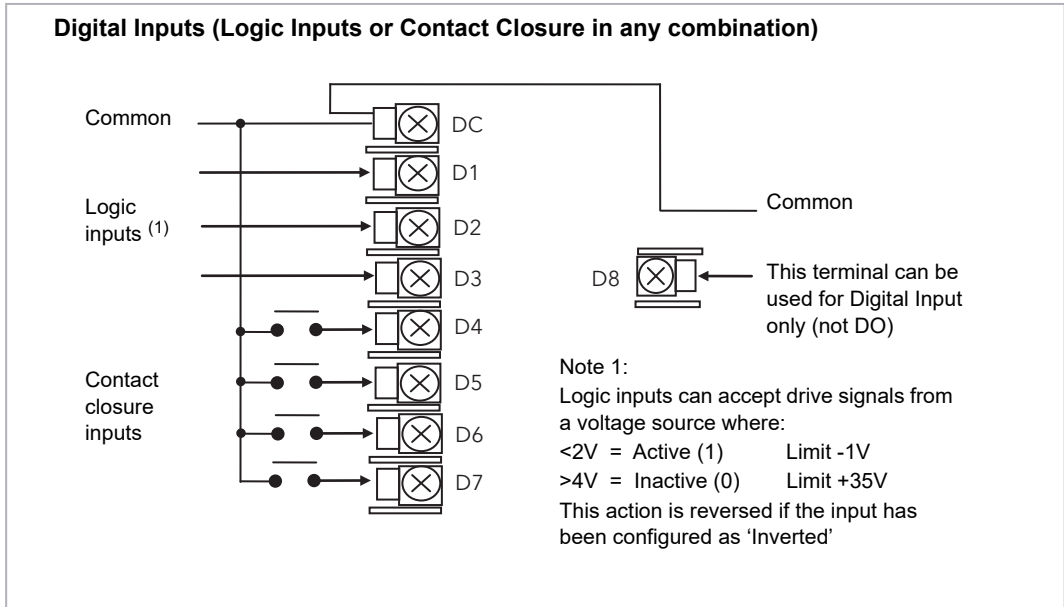

Figure 13 Wiring Connections for Digital I/O

Optional Plug in Module Connections

Digital Communications Connections

Digital Communications modules can be fitted in two positions in the 2704 controller. The connections being available on HA to HF and JA to JF depending on the position in which the module is fitted. The two positions could be used, for example, to communicate with a configuration package, such as 'iTools', on one position and to a PC running a supervisory package on the second position.

The connections shown in the following diagrams show EIA232, 2-wire EIA 485, 4-wire EIA 422 and master/slave communications to a second controller.

The diagrams show connections for 'bench top test' wiring. For a full description of the installation of a communications link, including line resistors, see Communications Handbook, Part No. HA026230, and EMC Installation Guide, part no. HA025464.

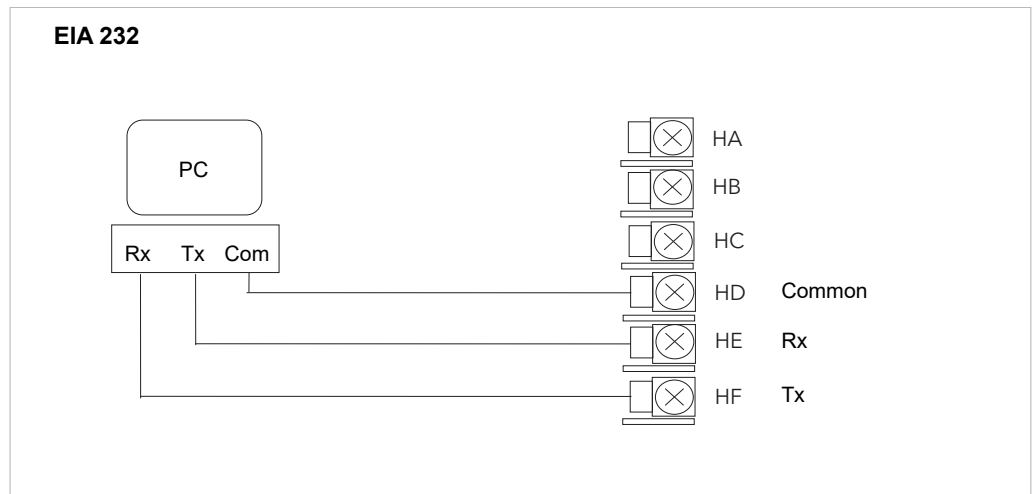

Figure 14 EIA232 Communications Connections

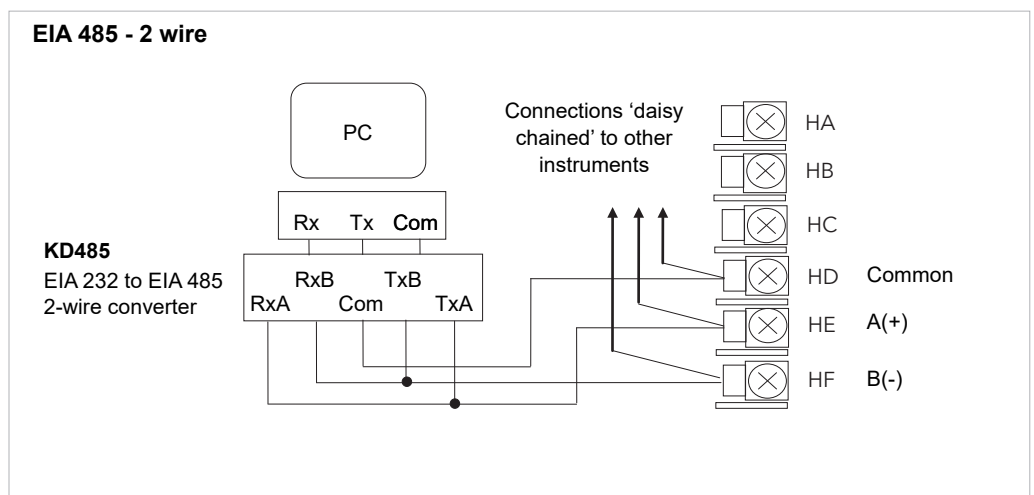

Figure 15 EIA 485 2- Wire Communications Connections

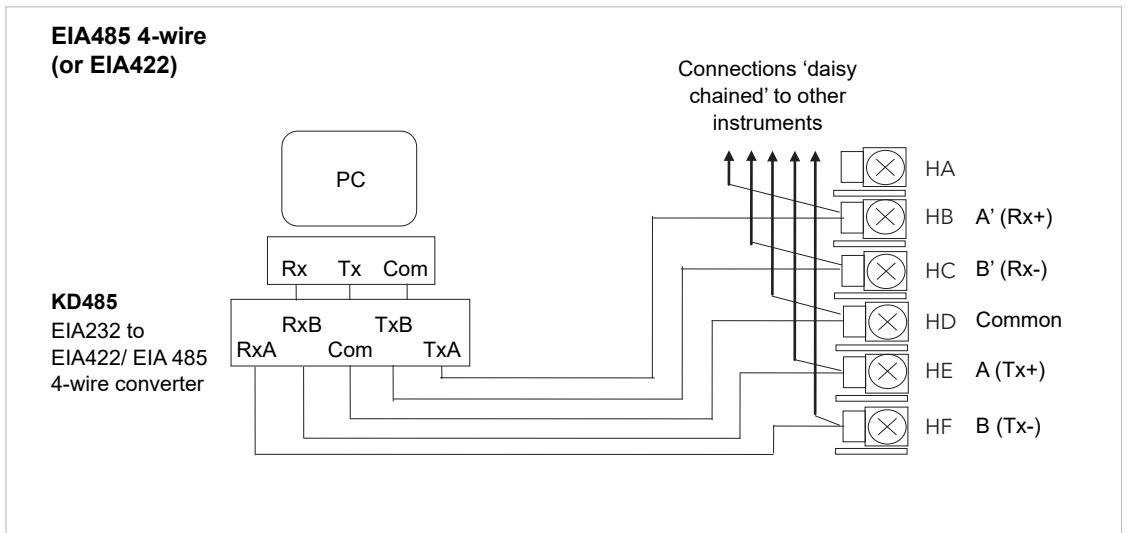

Figure 16 RS485 4-Wire Communications Connections

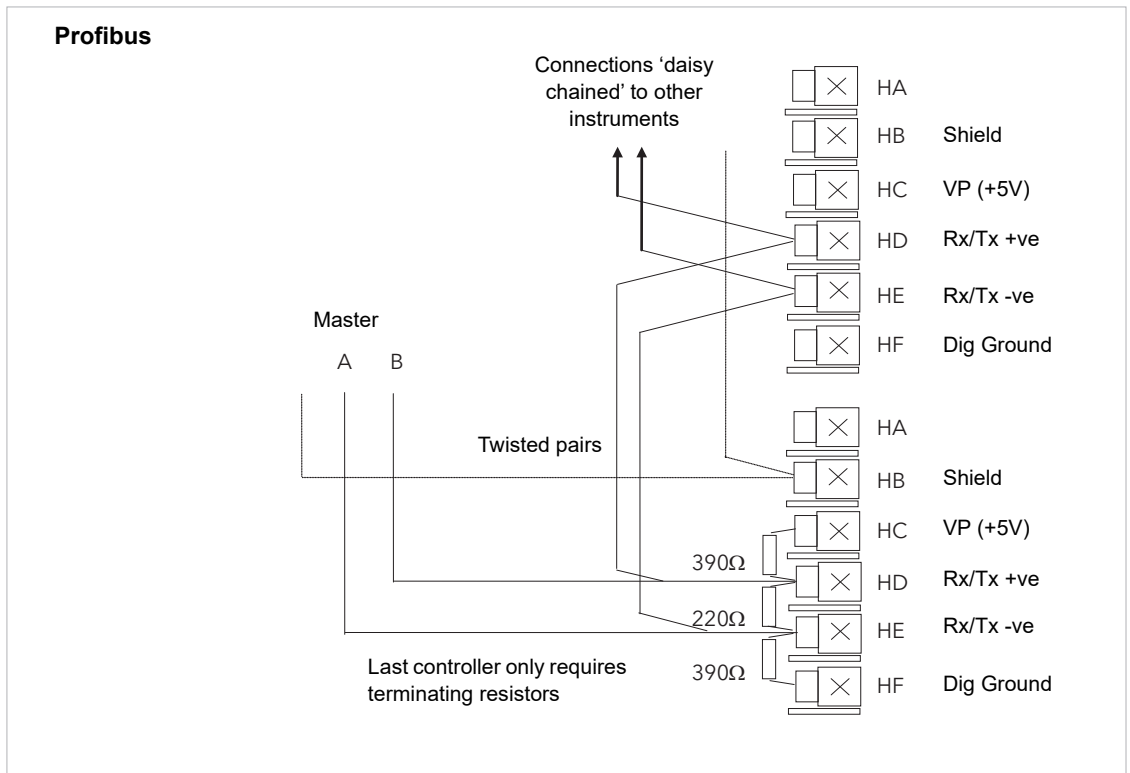

Figure 17 Profibus Wiring Connections

DeviceNet® Wiring

This section covers the DeviceNet digital communications option. To configure DeviceNet communications refer to the DeviceNet Handbook Part No HA027506.

DeviceNet Terminal Functions

Terminal Reference	CAN Label	Color Chip	Description
HA	V+	Red	DeviceNet network power positive terminal. Connect the red wire of the DeviceNet cable here. If the DeviceNet network does not supply the power, connect to the positive terminal of an external 11-25 Vdc power supply.
HB	CAN_H	White	DeviceNet CAN_H data bus terminal. Connect the white wire of the DeviceNet cable here.
HC	SHIELD	None	Shield/Drain wire connection. Connect the DeviceNet cable shield here. To prevent ground loops, the DeviceNet network should be grounded in only one location.
HD	CAN_L	Blue	DeviceNet CAN_L data bus terminal. Connect the blue wire of the DeviceNet cable here.
HE	V-	Black	DeviceNet network power negative terminal. Connect the black wire of the DeviceNet cable here. If the DeviceNet network does not supply the power, connect to the negative terminal of an external 11-25 Vdc power supply.
HF			Connect to instrument earth



Power taps are recommended to connect the DC power supply to the DeviceNet trunk line. Power taps include:

- A Schottky Diode to connect the power supply V+ and allows for multiple power supplies to be connected.
- Two fuses or circuit breakers to protect the bus from excessive current which could damage the cable and connectors.
- The earth connection, HF, to be connected to the main supply earth terminal.

Wiring Interconnections for DeviceNet Communications

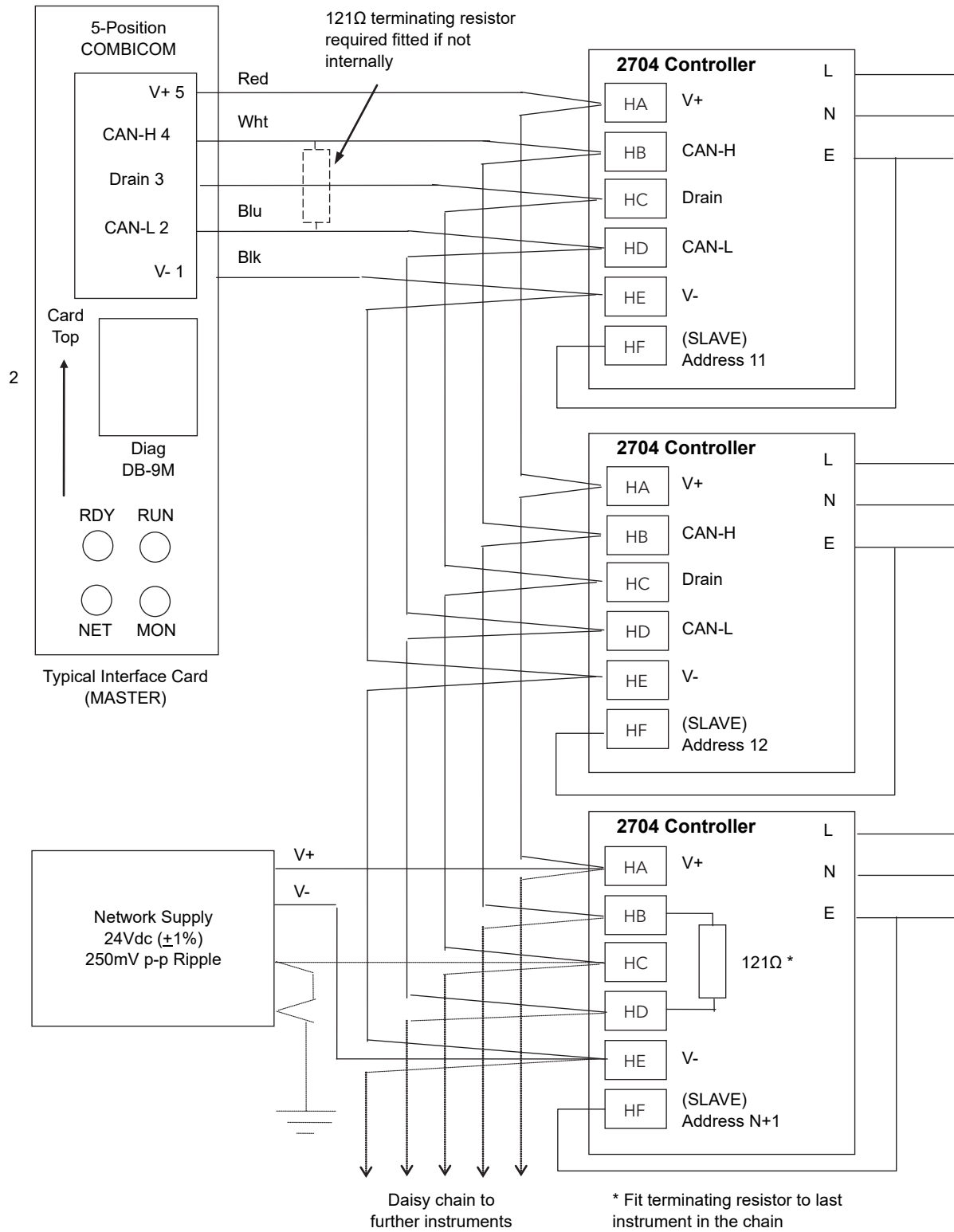

Figure 18 DeviceNet Wiring

Ethernet Connections

When the controller is supplied with the Ethernet communications option a special cable assembly is also supplied. This cable must be used since the magnetic coupling is contained within the RJ45 connector. It consists of an RJ45 connector (socket) and a termination assembly which must be connected to terminals HA to HF.

Use standard CAT5 cable to connect to the Ethernet 10BaseT switch or hub. Use cross-over cable only if connecting one-to-one with a PC acting as network master

View of cable which may also be ordered separately as Part No SUB27/EA

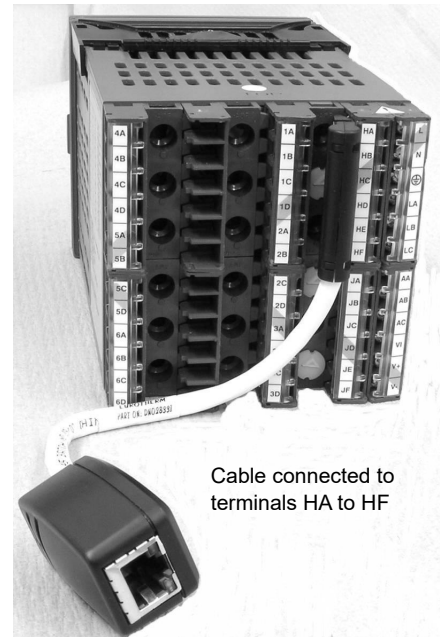

Cable connected to terminals HA to HF

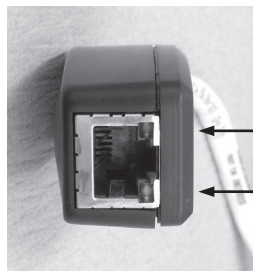

Activity and power on LED indicators

Figure 19 Ethernet Connections

I/O Modules

The 2704 controller contains five positions in which 4-terminal I/O modules can be fitted. These positions are marked Module 1, Module 3, Module 4, Module 5, Module 6, in Figure 6. Module 2 is reserved for the Memory Module which can only be fitted in this position. To find out which modules are fitted check the ordering code which is found on a label on the side of the instrument.

Any module, listed in this section, can be fitted in any position, except the PV input - limited to positions 3 and 6 only; and the Analogue Input module - cannot be fitted in slot 5. Care should be taken, therefore, to ensure that modules are fitted as expected from the order code. The instrument can be interrogated in 'View Config' level to locate the positions in which the modules are fitted. See Access Levels. If modules have been added, removed or changed it is recommended that this is recorded on the instrument code label.

I/O Module	Typical usage	H/W Code	Connections and examples of use
Note: The order code and terminal number is pre-fixed by the module number. Module 1 is connected to terminals 1A, 1B, 1C, 1D; module 3 to 3A, 3B, 3C, 3D, etc.			
Relay (2 pin) and Dual Relay max 264Vac, 2A, min 12V, 100mA	Heating, cooling, alarm, program event, valve raise, valve lower	R2 and RR	
Change Over Relay max 264Vac, 2A, min 12V, 10mA	Heating, cooling, alarm, program event, valve raise, valve lower	R4	
Isolated Single Logic Output 18Vdc at 24mA max	Heating, Cooling, Program events	LO	
Triple Logic Output (18Vdc at 8mA max. per channel)	Heating, cooling, program events	TP	

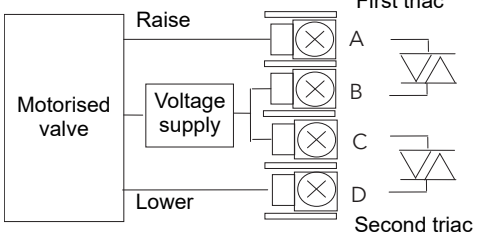
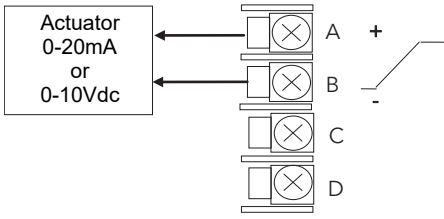
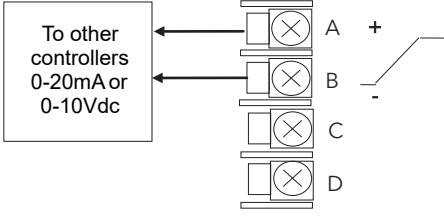
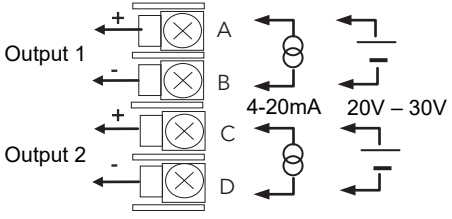
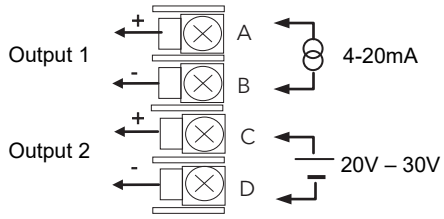
I/O Module	Typical usage	H/W Code	Connections and examples of use
<p>Triac and Dual Triac</p> <p>(0.7A, 30 to 264Vac combined rating)</p>	<p>Heating, cooling, valve raise, valve lower</p>	<p>T2 and TT</p>	 <p>Note: Dual relay modules may be used in place of dual triac.</p> <p>Note: The combined current rating for the two triacs must not exceed 0.7A.</p>
<p>DC Control</p> <p>(10Vdc, 20mA max)</p>	<p>Heating, cooling</p> <p>e.g. to a 4-20mA process actuator</p>	<p>D4</p>	
<p>DC Re-transmission</p> <p>(10Vdc, 20mA max)</p>	<p>Logging of PV, SP, output power, etc.,</p> <p>(0 to 10Vdc, or 0 to 20mA)</p>	<p>D6</p>	
<p>Dual DC Output</p> <p>(each channel can be 4-20mA or 24Vdc power supply)</p>	<p>Control output 12 bit resolution</p> <p>Can only be fitted in slots 1,4 or 5</p>	<p>DO</p>	
<p>High Resolution DC Output</p> <p>(one 15 bit 4-20mA plus one 24V power supply)</p>	<p>Retransmission in 'feedback mode'</p> <p>Fitted in slots 1,4 or 5 only</p>	<p>HR</p>	

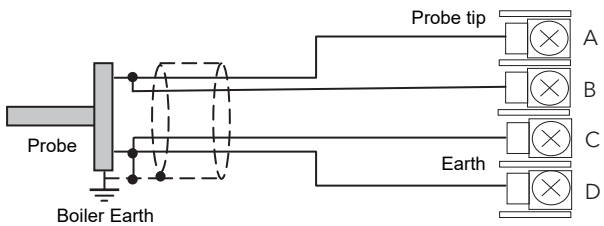
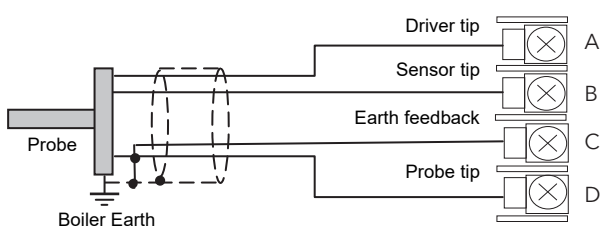
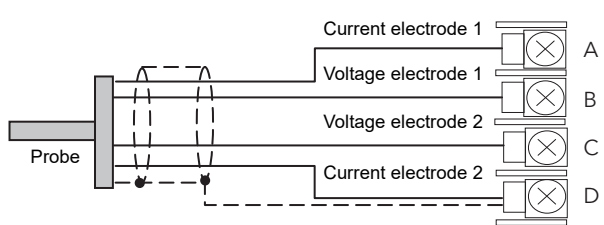
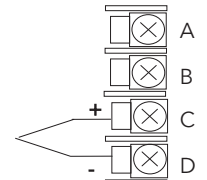
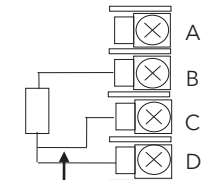
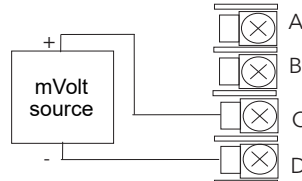
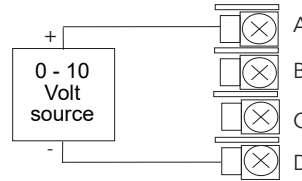
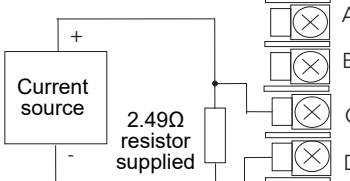
I/O Module	Typical usage	H/W Code	Connections and examples of use
<p>TDS Module</p> <p>TDS Control in boilers</p> <p>The diagrams show general wiring connections. Connection terminals vary from supplier to supplier. Particular attention must be made to grounding and screen connections as recommended by the supplier</p>			<p>2 Electrode TDS Probe</p>  <p>3 Electrode TDS Probe</p>  <p>4 Electrode TDS Probe</p> 
<p>PV Input (Modules 3 & 6 only)</p> <p>and</p> <p>Analogue Input (Modules 1, 3, 4 & 6 only)</p>	<p>Second or third PV input</p> <p>mV, V, mA, TC, RTD (Pt100) Zirconia probe</p> <p>Second or third PV input</p> <p>mV, mA, TC, RTD (Pt100)</p>	<p>PV</p> <p>AM</p>	<p>Thermocouple</p>  <p>3-wire RTD</p>  <p>For 2-wire this is a local link</p> <p>AM (up to 100mV)</p>  <p>Voltage 0 to 10V or 0 to 2V</p>  <p>Current 0 to 20mA (4 to 20mA)</p> 

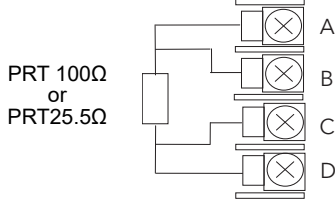
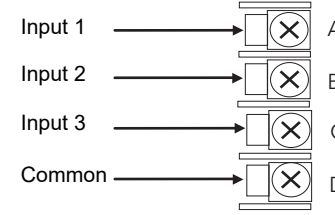
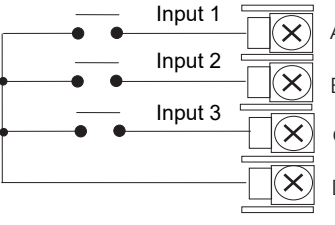
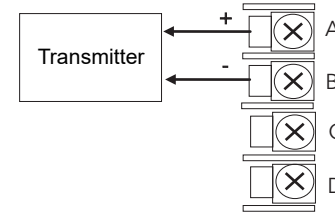
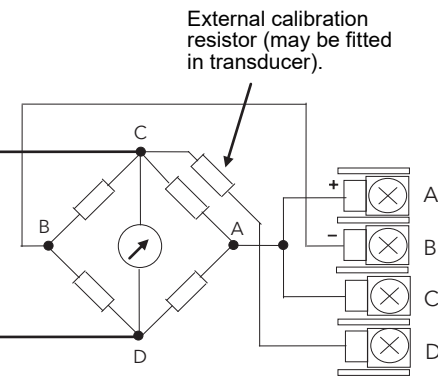
I/O Module	Typical usage	H/W Code	Connections and examples of use
<p>4-Wire PRT Input (Modules 3 & 6 only)</p>	<p>Two special versions of the PV Input module provide high accuracy, high stability temperature measurement. Code PH is PRT 100Ω Code PL is PRT 25.5Ω</p>	<p>PH PL</p>	<p style="text-align: center;">4-wire RTD</p>  <p style="text-align: center;">Use screened wires if longer than 30 metres</p>
<p>Triple Logic Input</p>	<p>Events e.g. Program Run, Reset, Hold</p>	<p>TL</p>	<p>Logic inputs</p> <p>Input 1 → [Terminal A]</p> <p>Input 2 → [Terminal B]</p> <p>Input 3 → [Terminal C]</p> <p>Common → [Terminal D]</p> <p><5V ON >10.8V OFF Limits: -3V, +30V</p> 
<p>Triple Contact Input</p>	<p>Events e.g. Program Run, Reset, Hold</p>	<p>TK</p>	<p>External Switches or Relays</p> <p>Input 1 → [Terminal A]</p> <p>Input 2 → [Terminal B]</p> <p>Input 3 → [Terminal C]</p> <p>Terminal D is unused.</p> <p>Contact inputs <100Ω ON >28KΩ OFF</p> 
<p>24V Transmitter Supply (20mA)</p>	<p>To power an external transmitter</p>	<p>MS</p>	
<p>Transducer Power Supply</p>	<p>Provide 5V or 10Vdc to power Strain Gauge Transducer + Shunt Contact</p>	<p>G3 or G5</p>	<p style="text-align: center;">External calibration resistor (may be fitted in transducer).</p>  <p>To Fixed or Module PV Input</p> <p>Note: To minimise noise pick up it is recommended that screened cables are used for strain gauge power supply connections.</p>

I/O Module	Typical usage	H/W Code	Connections and examples of use
<p>Potential-meter Input</p> <p>(100Ω to 15KΩ)</p>	<p>Motorised valve position feedback</p> <p>Remote SP</p>	<p>VU</p>	
<p>Dual PV Input</p> <p>(Modules 3 & 6 only)</p>	<p>To accept two inputs from a high level and a low level source. The two inputs are not isolated from each other.</p>	<p>DP</p>	 <p>The common connections to terminal D must be returned separately to D as shown in the dual current example above.</p>

Figure 20 Wiring Connections for IO Modules

To Connect Zirconia (Dual Signal) Probe

A dual signal probe, such as a Zirconia probe, will normally be connected to a Dual PV Input module (Code DP). The module presents two channels, A and C, where A is the voltage input and C is the mV, thermocouple, RTD or mA input.

Example 1 shown below uses the Dual PV Input module with both channels configured. In this configuration the module runs at 4.5Hz. The two channels are un-isolated from one-another but isolated from the rest of the instrument.

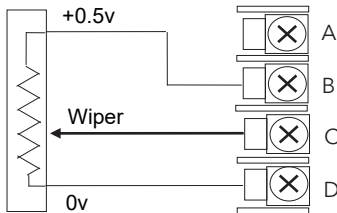
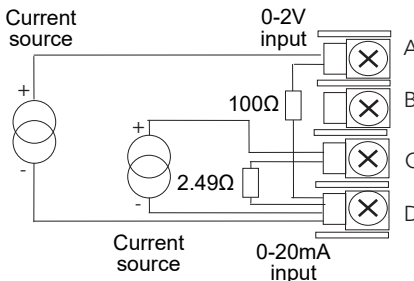
Example 2 uses two modules. The modules can either be two PV Input modules (code PV) or a Dual PV Input module (code DP) with Channel C configured as 'None' plus a PV Input module. This combination runs at 9Hz and may be used if the loop is unusually fast.

I/O Module	Typical usage	Order Code	Connections and examples of use
Dual PV Input	Zirconia probe	DP	<p>Example 1: Using the Dual PV Input Module. Channel C is shown configured for thermocouple. The temperature sensor of a Zirconia probe is connected to this input, terminals C & D. The Volt Source is connected to the A channel, terminals A & B.</p>  <p>Note: The +ve of the volt source must be connected to the -ve of the thermocouple.</p>
Two PV Input Modules		PV	<p>Example 2: Using Two Modules The temperature sensor of the zirconia probe can be connected to the precision PV input of one I/O module, connections C & D, with the Volt Source connected to the second module, terminals A & D.</p> 

Figure 21 Wiring Connections for Zirconia Probe

Zirconia Probe Screening

Zirconia Carbon Probe Construction

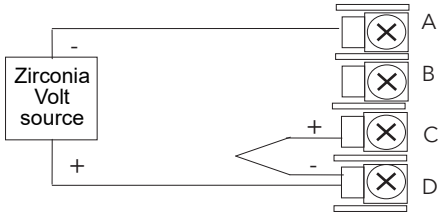
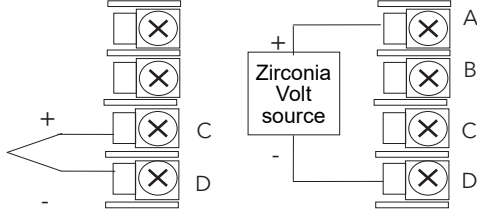
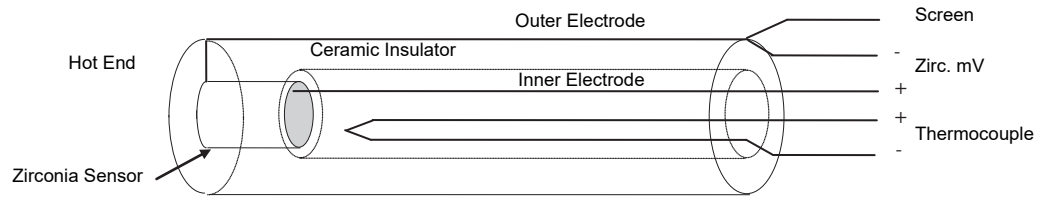

Figure 22 Zirconia probe construction

Screening Connections When Two Modules are Used

The Zirconia sensor wires should be screened and connected to the outer shell of the probe if it is situated in an area of high interference.

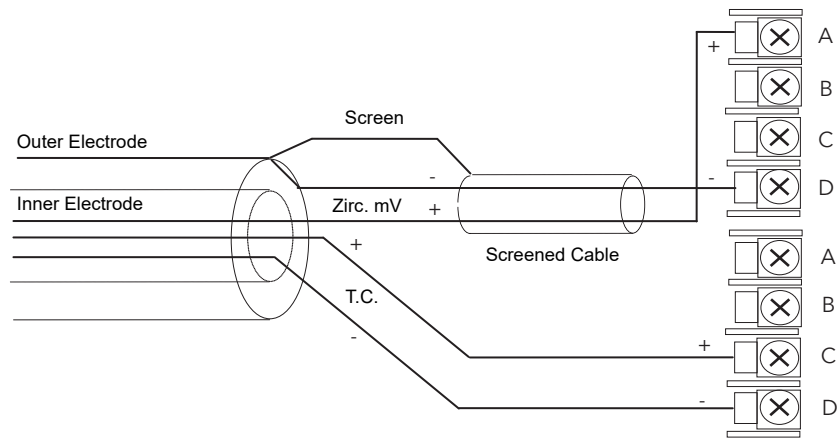

Figure 23 Screening connections - two module configuration

Screening Connections When a Dual Input Module is Used

Both the thermocouple and the Zirconia sensor wires must be screened and connected to the outer shell of the probe if it is situated in an area of high interference.

Note the reverse connection of the Zirconia sensor.

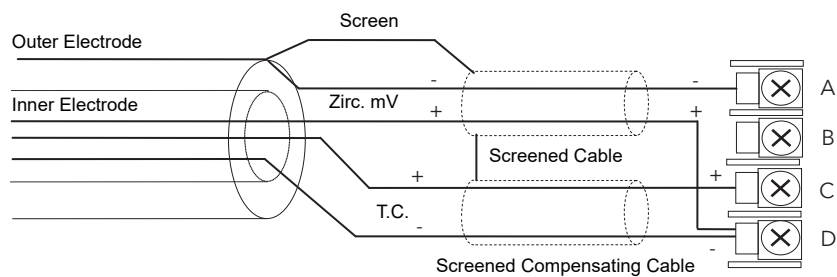

Figure 24 Screening connections - dual input configuration

Operation

This chapter describes day to day operation of the controller.

Operator Interface - Overview

The front panel of the 2704 consists of a 120 x 160 pixel electroluminescent display, and seven operator push-buttons. Figure 25 shows an example of a single loop display.

- The display is used to show the process conditions.
- The seven operator buttons allow adjustments to be made to the controller.

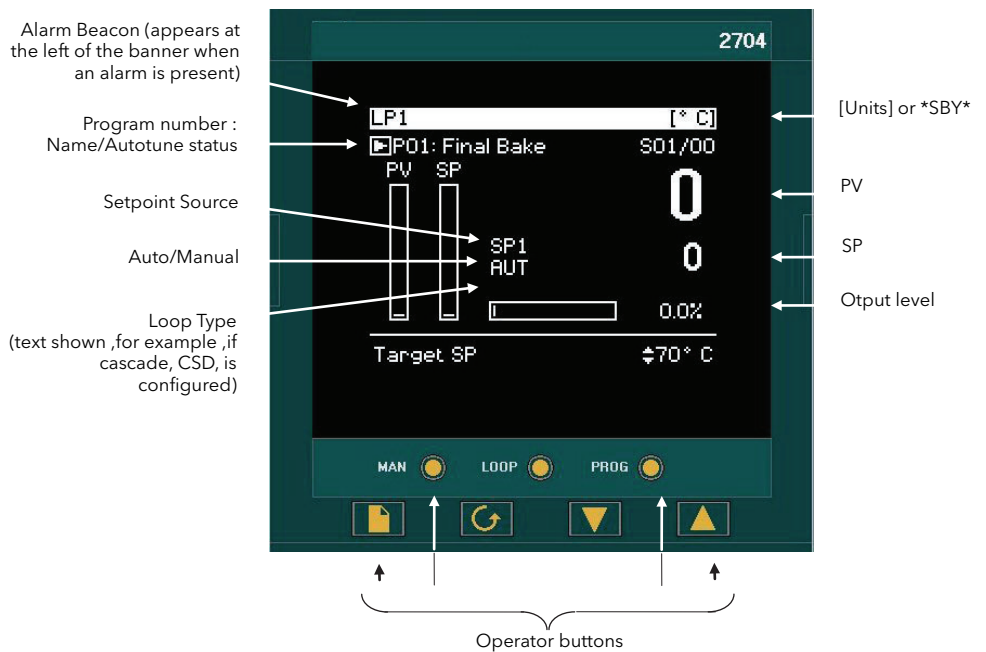

Figure 25 Operator Interface (Single Loop)

[Units] If units have been selected in configuration level they will be displayed on the status bar.

The choices are:-

°C/°F/°K

V, mV, A, mA

PH

mmHg, psi, bar, mbar, mmWg, inWg, inWW, PSIG

Ohms









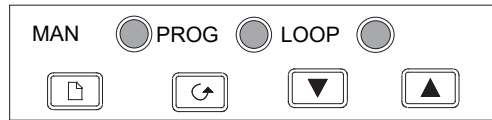



%, %RH, %O2, %CO2, %CP,

PPM

Custom units are also possible

The Operator Buttons



	<p>Auto/Manual button</p>	<p>When pressed, this toggles between automatic and manual mode:</p> <ul style="list-style-type: none"> • If the controller is in automatic mode 'AUT' is displayed • If the controller is in manual mode, 'MAN' is displayed
	<p>Loop select button</p>	<p>Each press selects each loop in turn or between each loop and the trend chart if each of the above options are configured plus a summary of all loops. <i>The loop name is shown in the banner at the top of the display</i></p>
	<p>Programmer button</p> <p>This button operates the programmer on all loops</p> <p>See also Programmer Configuration</p>	<ul style="list-style-type: none"> • Press PROG again to RUN a program <div data-bbox="427 629 850 752" style="border: 1px solid black; padding: 5px; margin: 10px 0;"> <p>Program Status</p> <p>  : Reset</p> <p> 1 : Program 1</p> </div> <p>The pop up window will remain for approximately 6 seconds and during this period:-</p> <ul style="list-style-type: none"> • Press PROG again to RUN a program  • Press PROG again to HOLD a program  • Press PROG again to toggle between RUN & HOLD • Press PROG and hold for two seconds to reset 
	<p>Page button</p>	<p>Press to select the Page Header 'Menu'.</p>
	<p>Scroll button</p>	<p>Press to select a new parameter from the page heading. If held down it will continuously scroll through the parameters.</p>
	<p>Down button</p>	<p>Press to decrease an analogue value, or to change the state of a digital value</p>
	<p>Up button</p>	<p>Press to increase an analogue value, or to change the state of a digital value</p>

Note: The AUTO, LOOP, or PROG may have been disabled in configuration level.

Figure 26 Operator Buttons

Status Messages

Messages appear on the display to show the current status of the controller. Table 1 below describes these messages:









LP1, LP2, LP3	Indicates which loop is being viewed. <i>LP1, LP2, LP3</i> may be user defined names. All user defined names are shown in <i>italics</i> throughout this manual
P01 to 50	Indicates which program is in use and its current status. P01: to P50: can be followed by a user defined name.
AUT	The selected loop is in automatic (closed loop) control
MAN	The selected loop is in manual (open loop) control
SP1, SP2, PO1 to PO50, REM	Indicates where the SP is derived, i.e. Setpoint 1, Setpoint 2, Programmer, Remote
CSD	Indicates that the loop is in cascade.
OVR	Indicates that the loop is in override.
RAT	Indicates that the loop is in ratio (Ratio must be enabled from the parameter list at the bottom of the display)
	Indicates a program is activated
	Indicates a program is held at its current levels
	Indicates a program is in reset condition i.e. not running
	When an alarm occurs an alarm symbol flashes in the header banner. When the alarm is acknowledged but is still active the symbol will be permanently lit. When the alarm is acknowledged but is no longer active the symbol will disappear. See Alarm Operation for further details.
[UNITS]	The process units are displayed in the right hand side of the banner
[SBY]	This symbol will flash in the right hand side of the banner in place of 'units' when the controller is in standby mode. In this state all interfaces to the plant are switched to a rest condition. For example, all control outputs = 0. When this symbol is on the controller is no longer controlling the process. This symbol will be on when:- <ul style="list-style-type: none"> • The controller is in configuration mode • Standby mode has been selected through the user interface or via an external digital input • During the first few seconds after start up

Table 1: Status Messages

Parameters and How To Access Them

Parameters are settings, within the controller, which determine how the controller will operate. They are accessed, using the  and  buttons, and can be changed, to suit the process, using the  and  buttons.

Selected parameters may be protected under different security access levels.

Examples of parameters are:-

Values - such as setpoints, alarm trip levels, high and low limits, etc.,
or

States - such as auto/manual, on/off, etc. These are often referred to as enumerated values.

Pages

The parameters are organised into different pages. A page shows information such as page headers, parameter names and parameter values.

Parameters are grouped in accordance with the function they perform. Each group is given a 'Page Header' which is a generic description of the parameter group. Examples are 'The Alarm Page', 'The Programmer Page', etc.,. A complete list of these is shown in the full navigation diagram, Section Navigation Overview.

Where a function has many parameters associated with it, the Page Header may be further sub divided into 'Sub-Headers'. The parameters are then found under this category.

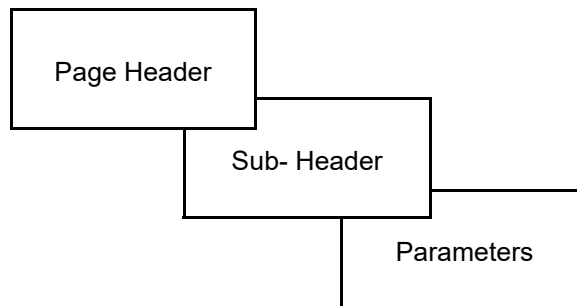

Figure 27 Page Types





It is possible to configure different start up pages as the Home page, but the principle of navigation is the same for all pages.

Note:



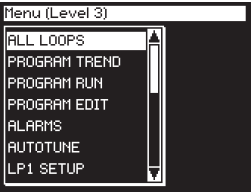



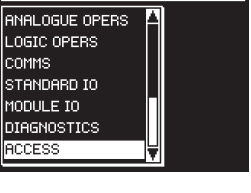









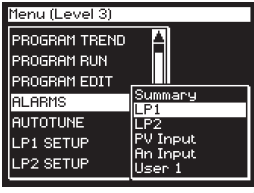

A page only appears on the controller if the function has been ordered and is enabled in Configuration mode. For example, if a programmer is not configured the RUN page and the EDIT PROGRAM pages will not be displayed in operation levels.

Navigation Overview

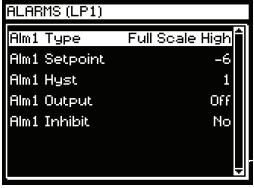
To Select a Page Header



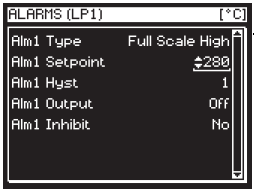

Do This	This Is The Display You Should See	Additional Notes
<p>1. From any display press  as many times as necessary to access the page header menu</p>		<p>The vertical bar on the right of the display indicates the position of the page header.</p>
<p>2. Press  to scroll down the list of page headers.</p>		<p>When the vertical bar reaches the centre of the screen the text moves up. This feature allows you to see previous and following page header names.</p>
<p>3 Press  to scroll back up the list of page headers.</p> <p>The sequence is repeated following further presses of  button</p>		<p>When the last name in the Page Header list appears at the bottom of the display, the vertical bar and the highlighted text will continue move downwards.</p>

To Navigate to a Parameter from a Page Header.

Do This	This Is The Display You Should See	Additional Notes
<ol style="list-style-type: none"> From any page press  as many times as necessary to select the list of Page Headers Press  or  to scroll up or down the list of page headers. 		<p>The vertical bar on the right of the display indicates the position of the page header.</p>
<ol style="list-style-type: none"> Press  to return to Page Header Press  to select the list of Page Sub-Headers for the highlighted Page Header. Press  or  to scroll up or down the list of page sub-headers 		<p>If a page does not contain a Sub-Header the display goes directly to 5 below</p>
<ol style="list-style-type: none"> Press  to return to Sub-Header Press  to select the list of Parameters in the highlighted sub-header. Press  or  to scroll up or down the list of parameters. 		<p>Press  to return</p>
<ol style="list-style-type: none"> Press  to select the parameter which you wish to change Press  or  to change the value 		<p>A flashing bar underlines the selected parameter.</p> <p>The parameter can only be altered if the value is preceded by </p> <p>If the value is read only it will be replaced by '-' for as long as the raise or lower buttons are pressed</p>

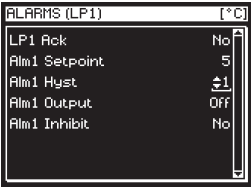

To Change Next Parameter in the List

This section describes how to select further parameters in the list which you may wish to alter or to view.

Do This	This Is The Display You Should See	Additional Notes
<ol style="list-style-type: none"> From the previous display, press  to select the next parameter which you wish to change Press  or  to change the value 		<p>The  button will allow you to scroll down the list.</p> <p>If this button is held down it will continuously scroll around the list, which will enable you to change a previous parameter.</p>



To Change Any Parameter in the List

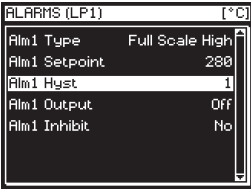

As stated above you can keep pressing or hold down the  button to continuously scroll around the list of parameters. There are two other alternatives. The first is to return to the highlight bar, described below. The second is 'Backscroll' described in the next section.

Do This	This Is The Display You Should See	Additional Notes
<ol style="list-style-type: none"> From the previous display, press  to highlight the parameter value and its name. Press  or  to scroll up or down the list. 		

Backscroll

In some cases it may be more convenient to scroll back up the list, for example, to select a new segment number when setting up a program.

A short cut is provided by holding down  and pressing  or .

Each press of  will step back to the previous parameter. Each press of  will step forward to the next parameter.

This function is provided as a short cut and is not necessary to navigate through the parameters.

Parameter Values

Parameter values can be displayed in different ways depending upon the parameter type. The different types of parameter, and how their values are changed, are shown below.

1. Numerical Values (eg Full Scale High Alarm Setpoint)

FS Hi Setpoint 200 ← Press ▲ to increase the value
 Press ▼ to increase the value

2. Enumerated Values (eg PV Input Alarm Acknowledge)

PV Alm Ack No ← Press ▲ to show next state
 Press ▼ to show previous state

3. Digital Values (e.g. programmer event outputs)

Prog Reset DO [] ← Press ↻ to step along the values. A cursor under the selected value flashes.
 Press ▲ or ▼ to turn the value on or off

4. Parameter Addresses (eg PV Src)

PV Src 05108:PVIn.Val ← Press ↻ to change the Parameter address. A cursor under the parameter address flashes.
 Press ▲ or ▼ to turn the value on or off.

↓
 Press ↻ to change from parameter address to parameter mnemonic

PV Src 05108:PVIn.Val ← Press ▲ or ▼ to change the parameter address by scrolling through a list of the most popular mnemonics. A cursor under the parameter mnemonic flashes.

5. Text (eg Program Name - User definable)

Program Name [] ← Press ↻ to step along the values. A cursor under the selected value flashes.

↓
 Press ↻ to change to the next character



Program Name Program 1 ← Press ▲ or ▼ to change the character. Up to 16 characters can be altered.

6. Time (eg Programmer Segment Duration)

Seg Duration 0:01:00 ← Press ▲ or ▼ to increase or decrease the time setting. This is an accelerating display.

Figure 28 Changing Parameter Values for Different Parameter Types

Confirmation Mechanism

Having changed a value, when the  or  key is released, the display will blink after a period of 1.5 seconds, indicating that the new parameter value has been accepted. If any other key is pressed during the 1.5 second period the parameter value is accepted immediately.

There are exceptions for specific parameters. Examples of these are:-

Output Power adjustment when in Manual mode. The value is written continuously as the value is changed.



Alarm Acknowledge. If the Alarm Acknowledge is changed from 'No' to

'Acknowledge' a confirmation message appears. Press  key to confirm the change. If no key is pressed for 10 seconds the value is restored to its previous value.

Invalid Key Actions

At any time some state transitions may be invalid, due, for example, to contention with digital inputs or to the current operating state of the instrument.

Examples are:-

1. Digital inputs have priority over the operator buttons.
2. If a parameter value cannot be changed the  prompt is not shown
3. If the  or  button is pressed for a read only parameter a number of dashes, ----, is displayed.

Parameter Tables

Subsequent chapters in this manual refer to parameter tables. These tables provide the full list of parameters available in 'Config' level in a particular page. The table below is an example.

- Column 1 gives the name of the parameter as it appears on the display.
- Column 2 is a description and possible usage of the parameter
- Column 3 is the range of values which can be set. This may be a numerical value, eg -n to +n, or the condition (enumeration) of a parameter, eg the parameter 'Program Status' has enumerations 'Run', 'Hold', 'Reset'.
- Column 4 is the default value (if applicable) of the parameter set during manufacture
- Column 5 is the access level required to change the parameter value.
 L1 means that the value is only shown in Level 1
 L2 means that the value is only shown in Level 1 and Level 2
 L3 means that the value is always available in the instrument operating mode Conf means Configuration Level
 R/O is Read Only
 Access Levels are described in Access Levels.

1 Parameter Name	2 Parameter Description	3 Value	4 Default	5 Access Level
Program Number	The number of the selected program			L3
Segment Number	The currently running segment number			L3
PSP1 Type	Program Setpoint 1 type			L3
PSP1 Working SP	Program Setpoint 1 working setpoint			L3
PSP1 Target	Program Setpoint 1 target setpoint			L3
PSP1 Dwell Time	Program Setpoint 1 dwell time			L3
This is a continuous loop which returns to the list header				

Note:

A parameter only appears if it is relevant to the configuration of the controller. For example, a programmer configured as Time to Target will not display the Rate parameter.

Parameter Availability and Alterability

A parameter which appears on a page is described as available. Parameters are not available if they are not appropriate for a particular configuration or instrument status. For example, relative cool gain does not appear in a heat only controller, and integral time does not appear in an On/Off controller.

A parameter described as alterable is preceded by the \blacklozenge symbol which indicates that its value can be changed. A parameter which is not alterable may be viewed (subject to availability), but may be changed by an instrument algorithm.

A parameter is alterable only if the following conditions are satisfied:

- The parameter is READ/WRITE
- The parameter does not conflict with the status of the instrument. For example, the proportional band will not be alterable if autotune is active
- The instrument keys must be enabled. Keys can be disabled by a logic input, turned off in configuration level or via digital communications. A logic input can be configured to disable front panel keys; this will not remove remote control of the user interface via digital communications.

The Navigation Diagram which follows shows all pages which are available at Config level.

Navigation Diagram

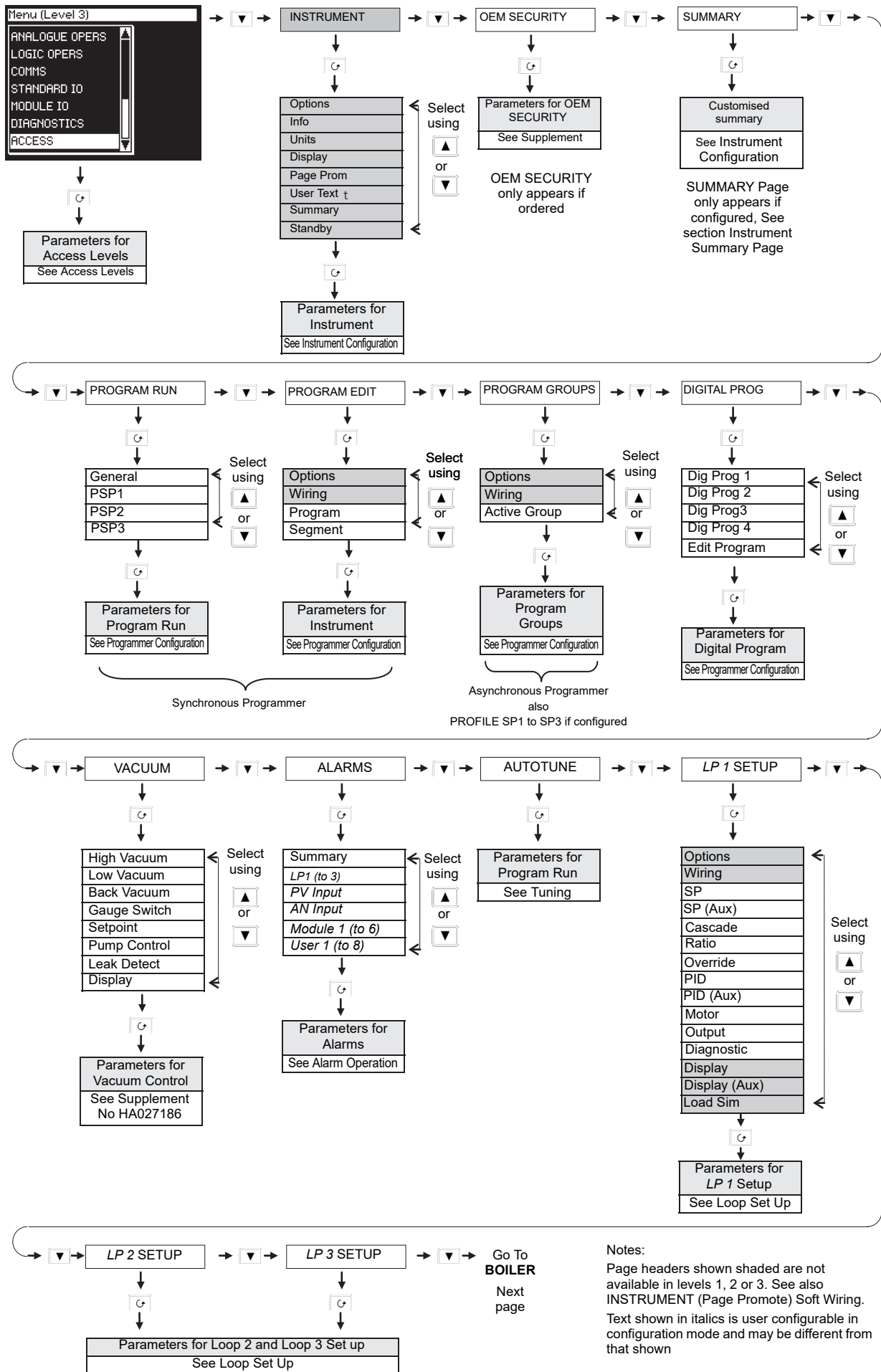

From LP3 SETUP

Previous page

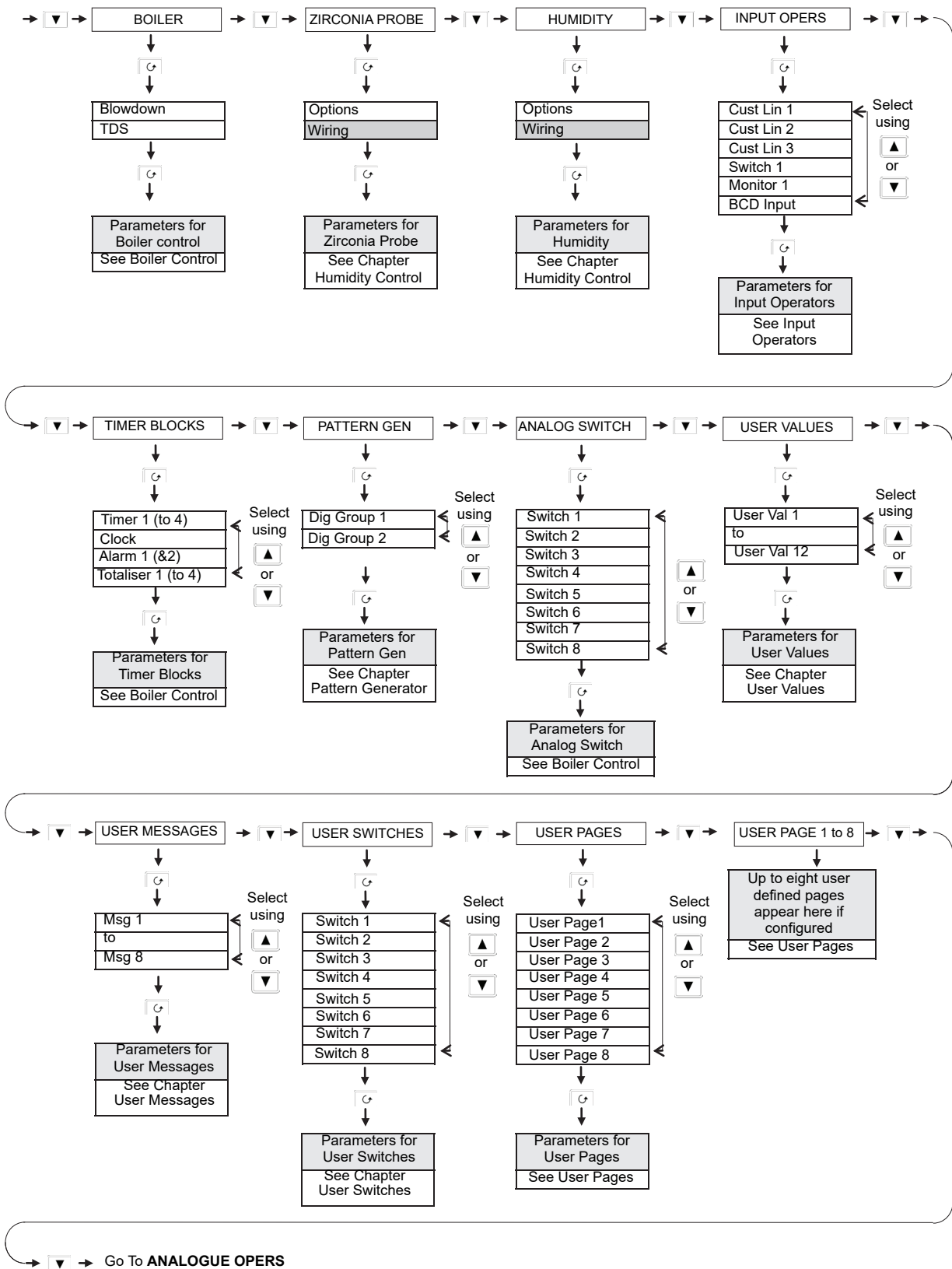

Next page

From **USER PAGE X**

Previous page

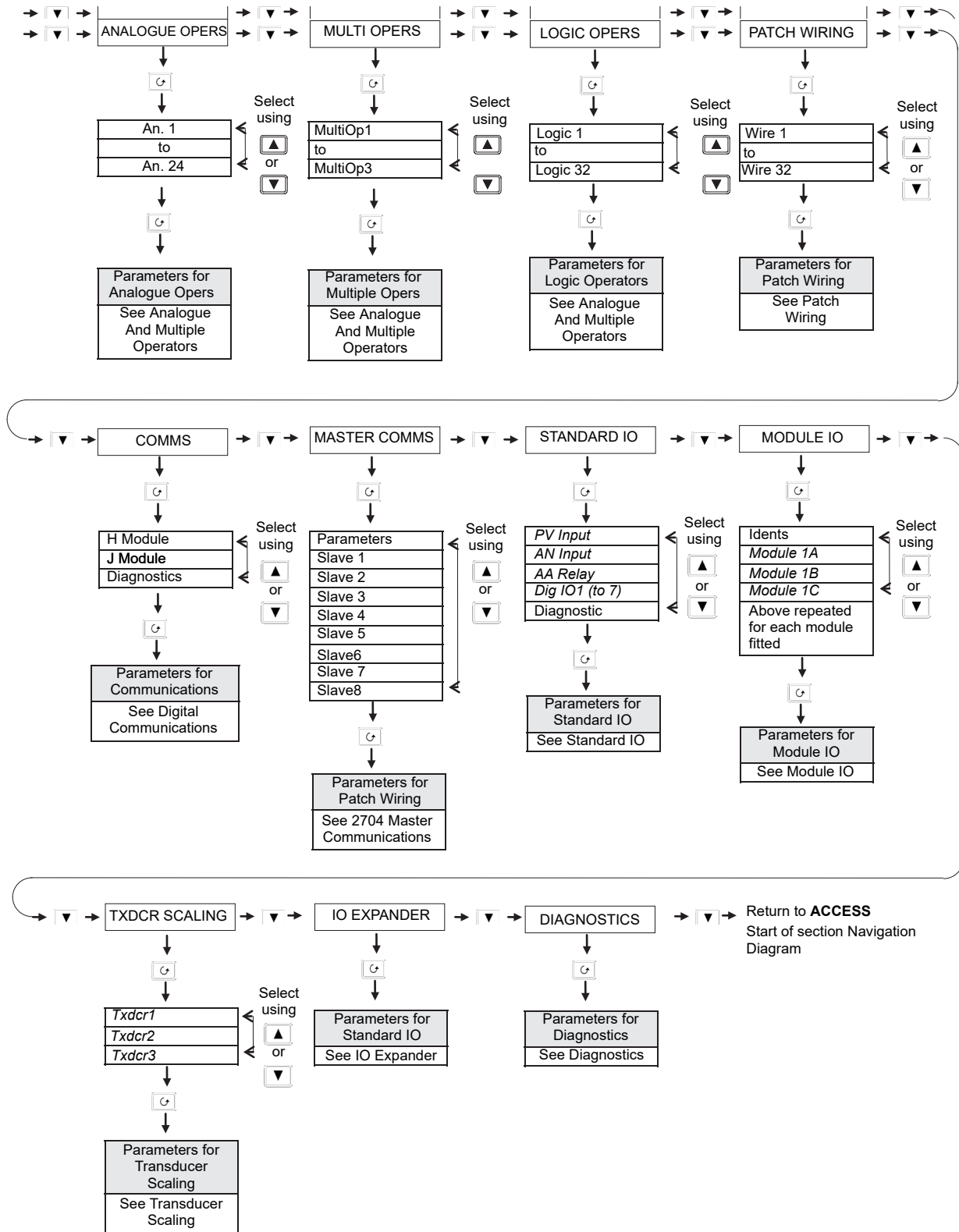

Function Blocks

What is a Function Block?

A function block is a software device which performs a control strategy. Examples are PID Controller, Setpoint Programmer, Cascade Controller, Timer, etc. A function block may be represented as a 'box' which takes in data at one side (as 'Inputs'), manipulates the data internally (using parameter 'Settings') and 'outputs' data at the other side to interface with analogue or digital IO and other function blocks. Figure 29 shows a representation of a PID function block as used in the 2704 controller.

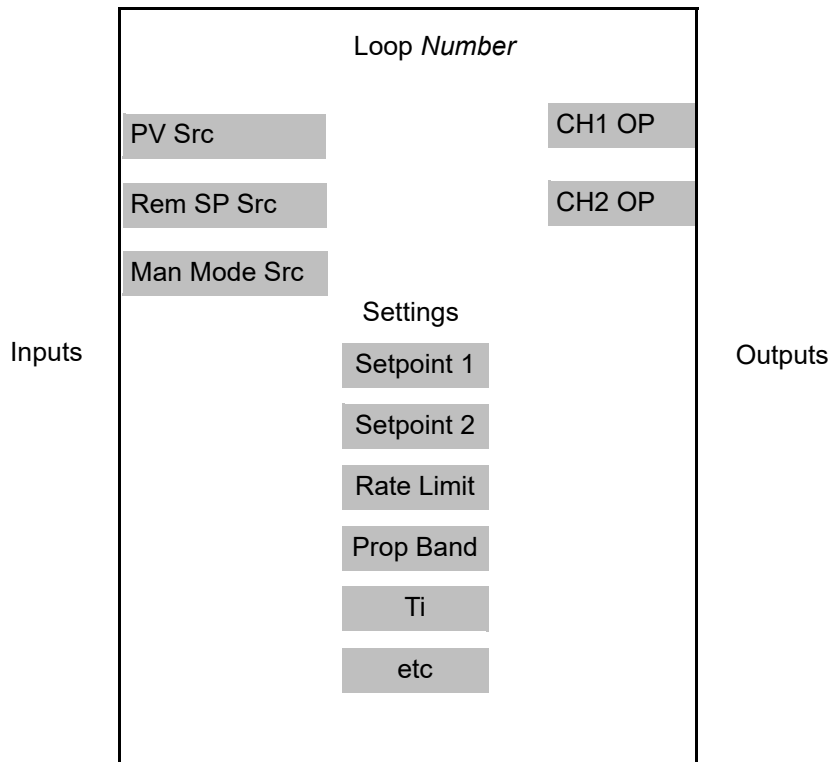

Figure 29 A Simple PID Function Block

Inputs

Inputs are provided to the function block from field sensors or from other function blocks within the controller. Each field input is served by an analogue or digital input block which processes the signal (depending upon the type of input) and makes it available to the function block in a useable form.

Each input 'wire' (see Soft Wiring) is labelled as 'Src' since it defines the source of the signal by holding its Modbus address.

Outputs

In a similar way the function block makes available signals to other blocks, plant actuators and other devices. Each output interfaces with analogue or digital output drivers which provide signals to the plant such as relay, 4-20mA, 0-10V outputs, etc

Settings

The purpose of a particular function block is defined by its internal parameters. Some of these parameters are available to the user so that they can be adjusted to suit the characteristics of the plant.

Examples of parameters available to the user are shown in Figure 29 as 'Settings'. In this manual these parameters are shown in tables an example of which is shown in Section Parameter Tables.

Soft Wiring

What is Soft Wiring?

Soft Wiring (sometimes known as User Wiring) refers to the connections which are made in software between function blocks. This chapter describes the principles of soft wiring through the operator interface of the instrument. iTools configuration software, available from your supplier, enables you to configure this feature using a PC.

In general every function block has at least one input and one output. Input parameters are used to specify where a function block reads its incoming data (the 'Input Source'). The input source is usually soft wired to the output from a preceding function block. Output parameters are usually soft wired to the input source of subsequent function blocks.

It is possible to wire from any parameter using its Modbus address. In practice, however, it is unlikely that you will wish to wire from many of the available parameters. A list of commonly wireable parameters has, therefore, been produced and these are displayed in the controller with both their Modbus address and a mnemonic of the parameter name. An example is shown in the Section To connect the PV input to the Loop i.e. 05108:PVIn.Val. The full list of these commonly wired parameters is given in Appendix D.

The function blocks used in this manual are drawn as follows:

1. Input parameters defined by 'Src' on the left of the function block diagram
2. Typically wired output parameters on the right hand side
3. Other parameters, which are not normally wired to, are shown as settings

A parameter which is not wired to can be adjusted through the front panel of the controller provided it is not Read Only (R/O) and the correct access level is selected.

All parameters shown in the function block diagrams are also shown in the parameter tables, in the relevant chapters, in the order in which they appear on the instrument display.

Figure 30 shows an example of how a PID function block (Loop 1) might be wired to other function blocks to produce a simple single loop controller. The Loop1'PV Src' input is soft wired to the output value from the Standard IO PV Input block on terminals V- to VH.

The channel 1 (heat) output from the PID block is soft wired to the input source ('Wire Src') of Module 1A, fitted as an output module.

Also in this example, a digital input to the 'Man Mode Src', allows the loop to be placed into manual depending upon the state of the digital input. The digital input is DIO1 connected to terminal D1 on the controller.

For further information on the configuration of the Standard IO and the Module IO see "Standard IO" and "Module IO" respectively.

Further examples of function block wiring are given in specific chapters throughout this manual.

An Example of Soft Wiring

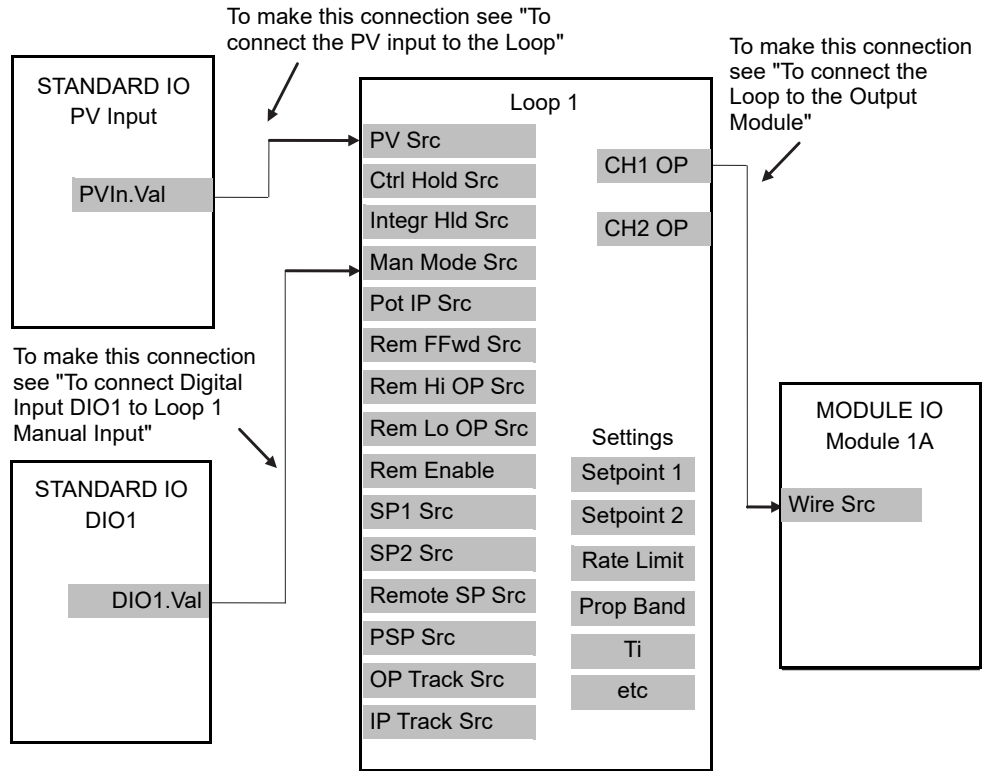

Figure 30 A Simple Wiring Example of a PID Function Block













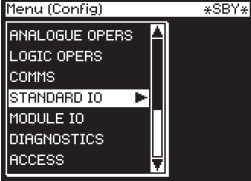



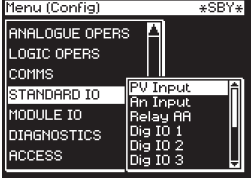

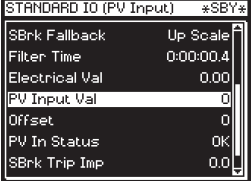

Configuration of the Simple PID Loop

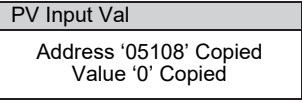



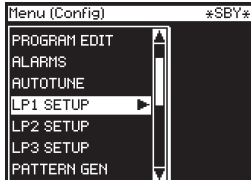

The following description explains how the wiring connections are made to produce the simple PID controller shown in Figure 30.

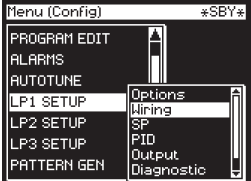
To connect the PV input to the Loop



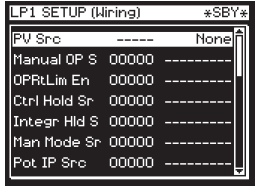

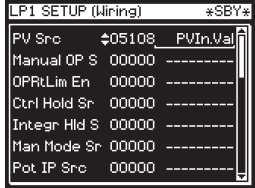

The example is to connect the output from the 'PV Input' to the 'PV Source' of Loop 1. Firstly, enter Configuration mode, as explained in Access Levels.

Then:-

Do This	This Is The Display You Should See	Additional Notes
<p>1. From any display press  as many times as necessary to access the page header menu</p> <p>2. Press  or  to select 'STANDARD IO'</p>	<p>Select the wire source</p> 	
<p>3. Press  to display the list of sub-headers</p> <p>4. Press  or  to select 'PV Input' (if necessary)</p>		
<p>5. Press  to display the parameter list</p> <p>6. Press  or  to select 'PV Input Val'</p>		This selects the 'PV Input Val' parameter which is to be <u>wired from</u> .
<p>7. Press   to copy this parameter.</p> <p>This button becomes a 'copy' button in configuration mode.</p>	<p>Copy the Parameter</p> 	<p>This display confirms that the parameter with Modbus address 05108 (ie PV Input.Val) has been copied.</p> <p>This display appears for as long as the A/M button is depressed.</p>
<p>8. Press  as many times as necessary to access the page header menu</p> <p>9. Press  or  to select 'LP1 SETUP'</p>	<p>Select the wire destination</p> 	
<p>10. Press  to display the list of sub-headers</p> <p>11. Press  or  to select 'Wiring'</p>		













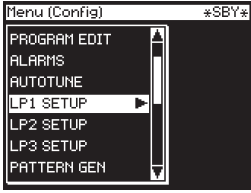



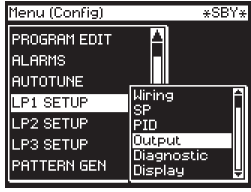

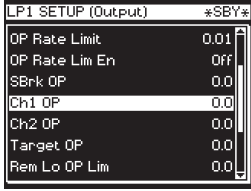

Do This	This Is The Display You Should See	Additional Notes
<p>12. Press  to display the parameter list</p> <p>13. Press  or  to select 'PV Src' (if necessary)</p>	<p style="text-align: center;">Select the wire source</p> 	<p>PV Src of LP1 is the parameter to be <u>wired to</u>.</p>
<p>14. Press the Loop Select button, , to paste the copied parameter ie 05108 to the PV Src of LPI.</p> <p>This button becomes a 'paste' button in configuration mode</p>	<p style="text-align: center;">Paste the wire</p> 	<p>The Loop Select button becomes a 'paste' button in this mode</p> <p>Press  to confirm</p> <p>Press  to cancel as instructed</p>

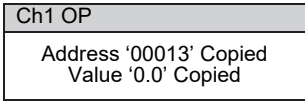



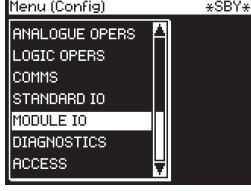

The parameter with Modbus address 05108 has now been pasted to PV Src.

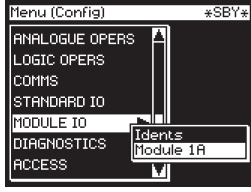
-  If the Modbus address is known or the parameter name is one that is listed in Appendix D it can be entered directly at stage 13 above as follows:-
- 1.Repeat stages 8 to 13
 - 2.At stage 13 press  to edit 'PV Src'. A flashing cursor appears under the modbus address
 - 3.If the modbus address is known, enter it here by pressing the  or  button
 - 4.If the modbus address is not known press . The display transfers to the name of the parameter.
 - 5.Press  or  to scroll through a list of parameter names.
- See Appendix D for the list of these parameters.

To connect the Loop to the Output Module

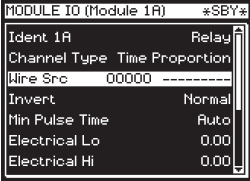
The example is Loop 1 Channel 1 output to Module 1A input.

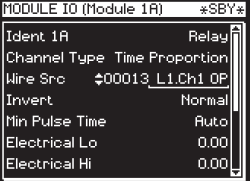
Do This	This Is The Display You Should See	Additional Notes
<p>1. From any display press  as many times as necessary to access the page header menu</p> <p>2. Press  or  to select 'LP1 SETUP'</p>	<p>Select the wire source</p> 	
<p>3. Press  to display the list of sub-headers</p> <p>4. Press  or  to select 'Output'</p>		
<p>5. Press  to display the parameter list</p> <p>6. Press  or  to select 'CH1 OP'</p>		<p>This selects the parameter to be wired from.</p>
<p>7. Press   to copy this parameter.</p> <p>This button becomes a 'copy' button in configuration mode.</p>	<p>Copy the wire source</p> 	<p>This display confirms that the parameter with Modbus address 00013 (ie CH1 OP) has been copied.</p> <p>This display appears for as long as the A/M button is depressed</p>
<p>8. Press  as many times as necessary to access the page header menu</p> <p>9. Press  or  to select 'MODULE IO'</p>	<p>Select the wire destination</p> 	
<p>10. Press  to display the list of sub-headers</p> <p>11. Press  or  to select 'Module 1A'</p>		

Do This	This Is The Display You Should See	Additional Notes
12. Press  to display the parameter list 13. Press  or  to scroll to 'Wire Src'		This is the parameter to be <u>wired to</u> .
14. Press the Loop Select button,  , to paste the copied parameter ie 00013 to the Wire Src of Module 1A. This button becomes a 'paste' button in configuration mode	<p style="text-align: center;">Paste the wire</p> 	The Loop Select button becomes a 'paste' button in this mode Press  to confirm Press  to cancel as instructed

 As in the previous example the modbus address can be entered at stage 13 above if it is known

 **Tip:**

You can page back by holding down the  button and pressing  button.

You can scroll back by holding down the  button and pressing  button.

To connect Digital Input DIO1 to Loop 1 Manual Input

The following description is given as a quick summary of the previous two examples.

1. Select the Wire Source 05402:DIO1.Val
2. Copy
3. Select the Wire Destination LP1 Man Mode Src
4. Paste

The source and destination of parameters is given in the Parameter Tables listed in following chapters.

Access Levels

Parameters are protected under five different levels of access for which security codes may be necessary. This chapter describes the different levels of access to the operating parameters available in the controller.

The Different Access Levels

Access Level	What you can do	Password Protection
Level 1	This is sometimes referred to as Operator Level since it allows operators to view and adjust parameters within limits set in higher levels. Any page available in levels 2 or 3 may be configured to appear in level 1. This is done from the configuration level using the page promote feature.	No
Level 2	This is sometimes referred to as Supervisor level since all the parameters relevant to a particular configuration are visible. All alterable parameters can be adjusted.	Yes
Level 3	These are parameters which are generally required when commissioning the controller. Any page at this level can also be configured to appear at Level 2.	Yes
Config	This level allows access to configure the fundamental characteristics of the controller and it is this level which is described in this manual.	Yes
View Config	This is a read only level which allows you to view the configuration of the controller. It is not possible to change parameter values in this level. It is not possible to read passcodes in this level.	Yes

Passcodes

On switch on the controller defaults to Level 1 which is not protected by a passcode. A limited set of parameters can be changed in this level. The parameter tables in each chapter list those parameters which can be changed.

Level 2, level 3 and Configuration level are protected by passcodes. The default passcodes set in a new controller are:

Level 2	Passcode '2'
Level 3	Passcode '3'
View Config	Passcode '2704'
Config	Passcode '4'









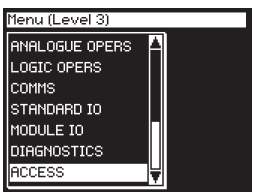

These passcodes, with the exception of View Config, can be changed in configuration level.

If a passcode of 'None' has been entered for any level (apart from View Config which is fixed) it will not be necessary to enter a passcode to enter that level.

Note:

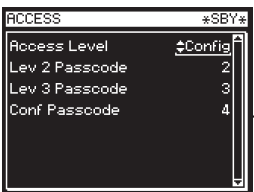
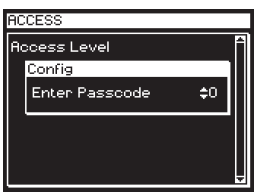

In configuration mode the controller enters a standby state in which all outputs are frozen. If the controller is connected to a process, it no longer controls that process when it is in Configuration mode.

To Enter Configuration Level

Do This	This Is The Display You Should See	Additional Notes
<p>15 From any display press  to return to the page header menu.</p> <p>16 Press  or  to select 'ACCESS'</p>		<p>This is the page header which contains the access levels</p>
<p>17 Press  to select the access level parameters</p>		
<p>18 Press  or  to select 'Config'</p> <p>19 Press  or  to enter the passcode.</p> <p>When the correct passcode is entered the display momentarily changes to  PASS, then back to the start level to confirm correct entry.</p>	 	<p>The default passcode of a new controller is 4 to enter Config level. If a new passcode has been entered in Config level this will be in the form 0 to 9999.</p> <p>If an incorrect passcode is entered, the display returns to  0.</p> <p>Note: In the special case that the passcode has been configured as None, the display will blink momentarily when Config level is selected and Config level will be entered immediately.</p>

To go from a higher level to a lower level does not require entry of a passcode.

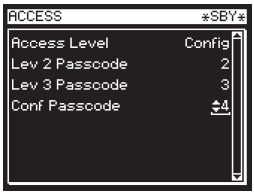
To Enter New Passcodes

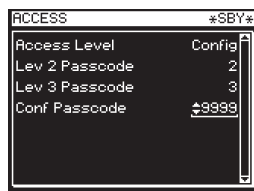
Do This	This Is The Display You Should See	Additional Notes
<p>1 From the previous display, press  to scroll to the level at which you wish to change the passcode</p>		<p>This will change the passcode for the configuration level</p>
<p>2 Press  or  to enter the new passcode, from 0 to 9999</p>		<p>The display will blink to accept the new passcode</p>

 When the controller is in Configuration Level *SBY* will flash in the status bar.

To Exit Configuration Level

To exit configuration level it is only necessary to select the level which you wish to go to. When entering a new level from a higher level it is not necessary to enter the passcode for this level. It is only necessary to enter the passcode when going from a lower level of access to a higher level.







Instrument Configuration

What is Instrument Configuration?

Instrument configuration allows you to enable and set up features within the instrument such as:-

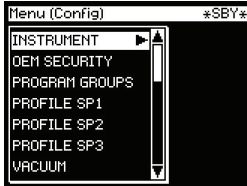
1. The number of loops
2. Control application - PID, Programmer, Zirconia, Humidity, Input Operators, Timer Blocks, Analogue and Logic Operators, Transducer Scaling
3. Display Units
4. The format of the display
5. The functions of the keys (buttons)
6. Promotion of selected parameters to different levels
7. To configure a 'library' of text defined by the user for use with a range of features within the instrument
8. Format of the Summary Page
9. Standby Behaviour



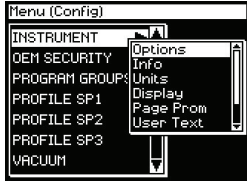









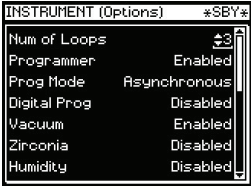

To Select the Instrument Configuration Pages

Do This	This Is The Display You Should See	Additional Notes
<ol style="list-style-type: none"> 1. From any display press  as many times as necessary to access the page header menu 2. Press  or  to select 'INSTRUMENT' 		<p>Views are typical and may vary depending upon options in any particular controller</p>
<ol style="list-style-type: none"> 3. Press  to display the list of sub-headers 4. Press  or  to scroll around the sub-headers 		<p>The choice of page headers is:-</p> <ul style="list-style-type: none"> Options Info Units Display Page Prom User Text Summary Standby

Note:

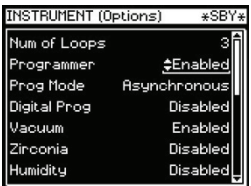
It is only possible to configure chargeable options which have been ordered. An example of a chargeable option is the number of loops. For other chargeable options see Order Code, Appendix A.

To Configure Controller Options

Do This	This Is The Display You Should See	Additional Notes
<p>1. Select INSTRUMENT (Options Page) as in section An Example of Soft Wiring</p>		
<p>2. Press  to display the list of parameters</p> <p>3. Press  or  to scroll around the parameters</p> <p>4. Press  to select a parameter. In this example 'Num of Loops'</p> <p>5. Press  or  to set the number of loops required</p>		<p>1, 2 or 3 loops can be selected if the option has been supplied</p>
<p>6. Press  to scroll to 'Programmer'</p> <p>7. Press  or  to change the value or state of the parameter</p>		<p>In this example the programmer function can be Enabled or Disabled</p>
<p>8. Press  to scroll to 'Prog Mode'</p> <p>9. Press  or  to change the value or state of the parameter</p>		<p>In this example the programmer mode can be Synchronous or Asynchronous</p> <p>This display appears for as long as the A/M button is depressed</p>
<p>10. Continue to select and change instrument options as described above.</p>		<p>The following table gives the full list of parameters available under INSTRUMENT list header</p>



Instrument Options Page

Table 3:	These parameters allow you to enable or disable instrument options. This table is only available in Configuration Level		INSTRUMENT (Options Page)
Parameter Name	Parameter Description	Further Info	Value
Num of Loops *	To configure the number of loops	Loop Set Up	1, 2 or 3
Programmer *	To enable or disable the programmer	Programmer Configuration	Disabled Enabled
Prog Mode	To select the type of programmer	Programmer Configuration	Synchronous Asynchronous
Digital Prog *	To enable or disable the digital programmer	Digital Programmer	Disabled Enabled
Vacuum	To enable or disable the digital programmer	Controller Applications	Disabled Enabled
Zirconia *	To enable or disable the zirconia block	Controller Applications	Disabled Enabled
Humidity	To enable or disable the humidity block	Controller Applications	Disabled Enabled
Input Opers	To enable or disable the Input Operators	Input Operators	Disabled Enabled
Timer Blocks	To enable or disable the Timer Blocks	Timer, Clock, Totaliser, Operation	Disabled Enabled
Pattern Gen	To enable or disable the pattern generator	Advanced Functions	Disabled Enabled
Analogue Switch	To enable or disable the analogue switches	Advanced Functions	Disabled Enabled
An/Logic Opers *	To enable or disable the Analogue and Logic Operators. Also includes Multiple Operators and Patch Wiring from software versions 6	Logic Operators and Analogue And Multiple Operators	Disabled Enabled
Txdcr Scaling	To enable or disable transducer scaling	Transducer Scaling	Disabled Enabled
IO Expander	To enable or disable the IO Expander	IO Expander	Disabled Enabled
Master Comms	To enable master comms	2704 Master Communications	Disabled Enabled
Boiler	To enable boiler control option	Boiler Control	Disabled Enabled
User Mbus Map	To enable user modbus map		Disabled Enabled
Clear Memory	Clear non-vol memory areas	No Programs User Text Promote Params Promote Pages All Memory	No
Load Sim	To enable or disable a control loop simulation for test/demonstration	Technical Note Ref TIN123	Disabled Enabled

* Can only be activated if ordered, see 'Ordering Code' Appendix A.

Note 1. Areas of memory which can be independently cleared are:-
Programs, User Text, Promoted Parameters, Promote Pages, All Memory.

Instrument Info Page

Table 4:		These parameters are read only and available in Level 3. They give information about the controller		INSTRUMENT (Info Page)
Parameter Name Press ↻ to select	Parameter Description	Value	Default	
Inst Type	Instrument type	2704		2704
Inst Serial No	Instrument serial number	Numeric		
Inst Version	Software version	e.g. V4.00		
CBC Version	Software version number of the 'cross board'	e.g. 40		
Feature Code 1	Codes required to upgrade			
Feature Code 2	chargeable features			
Inst 2nd Lang	Instrument language for user interface			
Alt Protocol	Alternative comms protocol	El Bisynch Modbus Profibus Devicenet		
ROM Size	ROM Size	eg 512K Word		
RAM Size	RAM Size	eg 128K Bytes		
NVOL Size	Non Volatile memory size	eg 128K Bytes		

Instrument Units Page

Table 5:		These parameters allow you to configure instrument units			INSTRUMENT (Units Page)
Parameter Name Press ↻ to select	Parameter Description	Value	Default	Access Level	
Temp Units	Temperature Units		None °C, °F, °K	Conf	
Custom Units 1			01:Usr1	Conf	
Custom Units 2	An index of customised	01:Usr1	01:Usr1	Conf	
Custom Units 3	display units selected from	to	01:Usr1	Conf	
Custom Units 4	User Text (section Instrument User Text Page)	50:Usr50	01:Usr1	Conf	
Custom Units 5			01:Usr1	Conf	
Custom Units 6			01:Usr1	Conf	

Instrument Display Page

Table 6:	These parameters allow you to configure the display		INSTRUMENT (Display Page)	
Parameter Name Press to select	Parameter Description	Value	Default	Access Level
Language	Display language	See note 1		Conf
Startup Text 1	Text which may be used to override the default message	01:Usr01 to 100:Usr100	Default Text	L3
Startup Text 2	Up to 100 text strings are available	01:Usr01 to 100:Usr100	Default Text	L3
Home Page	Defines which page is displayed in the lower readout after initialisation2.	See Note 2		L3
Home Timeout	To set a timeout for the display to return to the Home page.	None 9:99:99.9	0:10:00	Conf
All Loops Name	All loops summary page name	01:Usr01 to 100:Usr100	Default Text	Conf
Disable Keys	Yes will disable all front panel buttons when in operation levels	No Yes	No	Conf
Function Key 1	Function key 1 is Auto/Manual or disabled	Auto/Manual Disabled	Auto/Man	Conf
Function Key 2	Function key 2 is Loop Select key or disabled	View Loop Disabled	View Loop	Conf
Function Key 3	Function key 1 is Program Run/Hold or disabled	Run/Hold Disabled	Run/Hold	Conf
Disable Key	Disable all keys			Conf
Page Key Src	Keys may be wired to an external source such as a digital input for remote panel operation.			Conf
Scroll Key Src				Conf
Lower Key Src				Conf
Raise Key Src		Modbus		Conf
Func Key 1 S		address		Conf
Func Key 2 S				Conf
Func Key 3 S				Conf
Func1 Pressed (1)	State of function key 1	No	No	Conf
Func2 Pressed (1)	State of function key 2	Yes	No	Conf
Func3 Pressed (1)	State of function key 3		No	Conf

Notes:

1. The 2704 stores the user interface in two languages. English is always available plus French, German or Spanish.
2. The first page to be displayed when the instrument is switched on can be chosen from:

LP1, LP1 A., LP2, LP2 A., LP3, or LP3 A. (In 2704 *LPx* and *LPx A* have the same effect)

Access Page

Cycle Each Loop

All Loops

LP1 Trend, LP2 Trend, LP3 Trend

Program Mimic

User Pages 1 to 8 (may show user defined names)

Vacuum













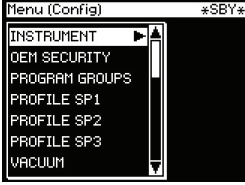

SUMMARY

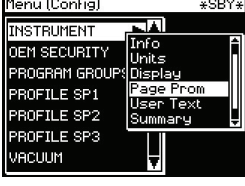
Program Run

3. These may be wired to function blocks to trigger other events in the system.
4. Text in italics can be customised
5. A parameter marked as available in Access Level 'L3' means that it will be visible if the page is promoted from configuration level to Level 3.

Instrument Page Promote Page

Any page shown un-shaded in the Navigation Diagram, section Navigation Overview, can be promoted to Level 1, Level 2 or Level 3 as follows:-















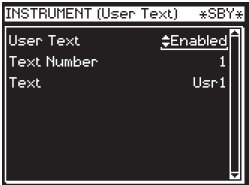

Do This	This Is The Display You Should See	Additional Notes
<ol style="list-style-type: none"> 1. From any display press  as many times as necessary to access the page header menu 2. Press  or  to select 'INSTRUMENT' 		Views are typical and may vary depending upon options in any particular controller
<ol style="list-style-type: none"> 3. Press  to show sub-headers 4. Press  or  to select 'Page Prom' 		<p>The choices are:-</p> <ul style="list-style-type: none"> Options Info Units Display Page Prom User Text Summary Standby
<ol style="list-style-type: none"> 5. Press  to show parameters 6. Press  or  to scroll to the name of a page which you wish to promote to levels 1, 2 or 3. 7. Press  to edit 8. Press  or  to choose the level at which you wish the page to be displayed 		<p>The choices are Lev1, Lev2, or Lev3.</p> <p>In this view, the Summary and Program Mimic pages will only displayed at Operator Levels 1 and higher. All others at Lev 3 only</p> <p>Note:- Not all parameters in a page will be seen. For example, parameters marked as available in a higher level eg 3 will not be shown in the page if it is promoted to a lower level.</p>

Repeat the above for every page which you wish to promote to a different level.

Instrument User Text Page

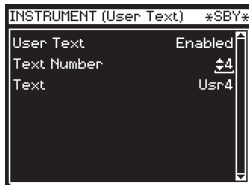
This page allows you to configure up to 100 User Text strings of up to 16 characters. Any string can be used to provide a name for particular parameters. For example Loops can be given names which are more meaningful to the user, such as 'Zone 1', 'Level Controller', etc. (To use a customised name, go to the relevant page such as LPx SETUP/Display page or MODULE IO/Module x page. Examples are given at the end of this chapter).



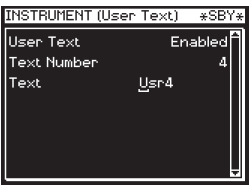







To enter User Text:-

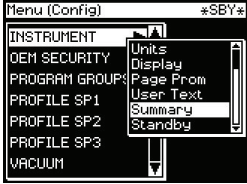



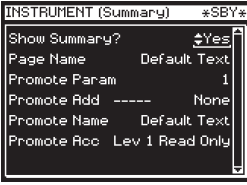



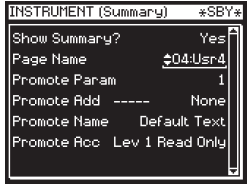



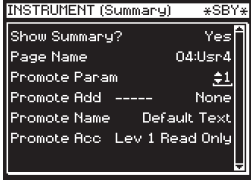



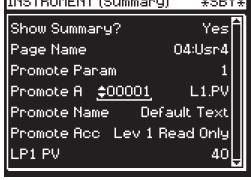

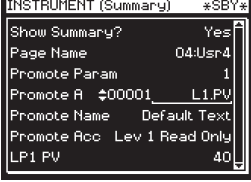

Do This	This Is The Display You Should See	Additional Notes
<ol style="list-style-type: none"> 1. From the 'INSTRUMENT' page header, press  to display the list of sub-headers 2. Press  or  to select 'User Text' 		Views are typical and may vary depending upon options in any particular controller
<ol style="list-style-type: none"> 3. Press  to show sub-headers 4. Press  to edit 'User Text' 5. Press  or  to 'Enabled'. 		If ' Disabled ' no further parameters are available
<ol style="list-style-type: none"> 6. Press  to select 'Text Number' 7. Press  or  to choose the text number to be configured 		Up to 100 Text Numbers are available
<ol style="list-style-type: none"> 8. Press  to select 'Text' 9. Press  or  to set the first (under-scored) character of the user text 10. Repeat 8 and 9 above to set every character in the required text 		<p>'Usrx' is the default text which is replaced by the text of your choice.</p> <p>Up to 16 characters are available</p>

Instrument Summary Page

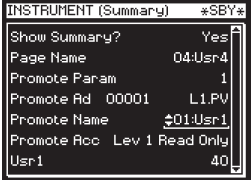
These parameters allow you to configure a page consisting of a list of up to 10 parameters which are in common use on a particular installation. The first parameter in the list - 'Show Summary' must be enabled so that the summary list is shown in operating levels.

To configure Summary pages:-

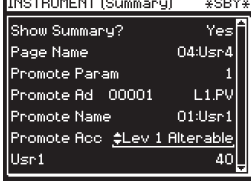
Do This	This Is The Display You Should See	Additional Notes
To Show the Summary Page in Operating Levels		
<ol style="list-style-type: none"> 1. From the 'INSTRUMENT' page header, press  to display the list of sub-headers 2. Press  or  to select 'Summary' 		<p>Views are typical and may vary depending upon options in any particular controller</p> <p>The level at which the Summary Page is shown is selected by the Page Promote section Instrument User Text Page</p>
<ol style="list-style-type: none"> 3. Press  to show the list of parameters 4. Press  to select 'Show Summary?' 5. Press  or  to 'Yes'. 		<p>If Yes is selected the Summary Page, which consists of up to 10 parameters, will be shown in the Main Menu following INSTRUMENT (or OEM SECURITY if ordered, see Navigation Diagram, section 1.12)</p> <p>If 'No' is selected the Summary page will not be shown.</p>
To Allocate a Name to the Summary Page		
<ol style="list-style-type: none"> 1. Press  to select 'Page Name' 2. Press  or  to select the required name from the User Text 'library' 		<p>Up to 100 user defined text Names are available.</p> <p>The previous section explains how User Text is set up.</p>

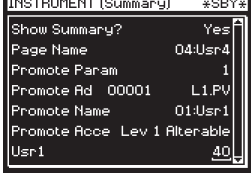
Do This	This Is The Display You Should See	Additional Notes
To Select the First Parameter which is to Appear on the Summary Page		
<ol style="list-style-type: none"> 1. Press  to select 'Promote Param' 2. Press  or  to select '1' (if necessary) 		<p>Up to 10 parameters are available</p>
<ol style="list-style-type: none"> 3. Press  to select 'Promote Ad' 4. Press  or  to select the required parameter using its Modbus address 		<p>The flashing _ indicates the value to be changed</p>
<p>If the Modbus Address is not known it is possible to select the required parameter from a list of commonly used parameters. This list is shown in Appendix D</p>		
<ol style="list-style-type: none"> 5. Press  again 6. Then press  or  to scroll through a list of commonly used parameters 		
To Select a User Defined Name for the First Parameter in the List		
<ol style="list-style-type: none"> 1. Press  to select 'Promote Name' 2. Press  or  to select the name from the User Text library 		<p>The name of the parameter is chosen from the User Text library.</p>
To Set the Access level for the First Parameter in the List		
<ol style="list-style-type: none"> 1. Press  to select 'Promote Access' 2. Press  or  to select the Access Level 		<p>This sets the level to which the parameter is promoted. The choices are:- Lev 1 Read Only Lev 1 Alterable Lev 2 Read Only Lev 2 Alterable</p>
<ol style="list-style-type: none"> 3. Press . This shows the first parameter which will appear in the operation level selected in 7 above. 		<p>The actual value of the parameter is shown in this display together with its allocated units</p>

Repeat the above steps for up to 10 parameters which are to be promoted to the Summary page.

Summary Page Example

This is an example of a Summary Page showing five parameters produced by the above procedure.

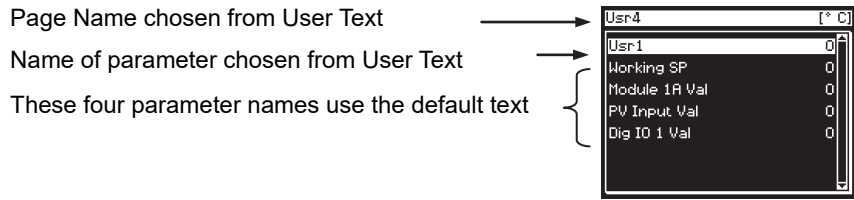

Instrument Standby Page

The standby state of the controller occurs when it is in configuration mode or during the first few seconds after switch on, see also Section Status Messages.

The INSTRUMENT Standby Page allows you to wire to a parameter such as a digital input which when true will switch the controller to Standby Mode.

Example: To wire Standby to Fixed Digital Input 1.

Do This	This Is The Display You Should See	Additional Notes
1. From the 'INSTRUMENT' page header, press to display the list of sub-headers 2. Press or to select 'Standby'		Views are typical and may vary depending upon options in any particular controller
3. Press to show the list of parameters 4. Press to select 'Standby' 5. Press or to 'On'.		If On is selected the controller will be switched to Standby Mode when the event (DI01) becomes true. If Off is selected the event is ignored.
6. Press to select 'Standby Src' 7. Press or to select the Modbus Address of the parameter to be wired to		The Modbus Address of Fixed Digital Input number 01 is 05402
8. Press again 9. Then press or to scroll through a list of commonly used parameters		If the Modbus Address is not known the parameter can be selected its mnemonic. See Appendix D for a list of these commonly used parameters.

If the Modbus Address is not known it is possible to select the required parameter from a list of commonly used parameters. This list is shown in Appendix D

☺: See 'Copy and Paste' Section Configuration of the Simple PID Loop.

User Text Examples

To Re-Name Loop 1 to Zone 1

First enable User Text since its factory default is disabled. A library of User Text can then be created from which the new loop name can be selected.

Implementation

1. In INSTRUMENT/User Text Page
 - set User Text = Enabled
 - set 'Text Number' = 1 (or any unused text no.)
 - set 'Text' = Zone 1
 - This defines Text Number 1 to be Zone 1.
2. In LOOP 1 SETUP /Display Page
 - set 'Loop Name' = 01:Zone 1
 - This replaces the default name (LP1) with Zone 1

To Re-Name User Alarm 1 and Provide a Message

User alarms can be re-named and also provide a diagnostic message to the user.

Implementation

1. In INSTRUMENT/User Text Page
 - set User Text = Enabled
 - set 'Text Number' = 2 (or any unused text no.)
 - set 'Usr2' = High Temp
 - This defines Text Number 2 to be High Temp.
 - set 'Text Number' = 3 (or any unused text no.)
 - set 'Usr3' = Check Chiller
2. In ALARMS/User 1 Page
 - set 'Name' = 02:High Temp
 - This replaces the default name with High Temp
 - Set 'Message' =03:Check Chiller

- | | | |
|---|------------------------------|--|
| 2. | In STANDARD IO /Dig IO1 Page | set Channel Type = Digital Input
This page also allows you to set the input for inverted operation |
| 3. | In LOGIC OPERS/Logic 1 Page | set 'Operation = OR
set 'Input 1 Src = 05402:DIO1.Val
set 'Input 2 Src = 05402:DIO1.Val
This connects digital input 1 to logic operator 1. Note: it is necessary to wire to both inputs of a logic (or analogue operator) |
| 4. | In INSTRUMENT/Summary Page | set 'Show Summary? = Yes
set 'Promote Param' = 1 (or the text no. above)
set 'Promote Addr' = 07176:LgOp1.OP
The logic operator is defined simply to provide On/Off annunciation in the display Summary page. |
| 1. In later instruments you can use Custom Enumerations | | |
| 1. | In INSTRUMENT/User Text Page | set User Text = Enabled
select a User 'Text Number' e.g. 9 (or any unused text)
set 'Usr9' = On
select the next User 'Text Number' e.g. 10
set 'Usr10' = Off |
| 2. | In STANDARD IO /Dig IO1 Page | set DigIO Enum = User Text 6 i.e. 09:On |

The enumeration of the parameter called Test1 will change between 09:On and 10:Off.



You can use any text for the enumeration, for example Open/Closed, Up/Down, etc.

Programmer Configuration

This chapter explains:

- The features of a setpoint programmer in general
- How to configure and edit a Synchronous Programmer
- How to configure an Asynchronous Programmer (software versions 6 onwards)

Customisable Parameter Names

Throughout this chapter parameter names shown in italics are customisable by the user when in configuration access level. The name of the parameter may vary, therefore, from instrument to instrument.

Typical customisable parameter names are:

- Program names
- Profile Setpoint names
- Segment names
- Digital Event Names

What is Setpoint Programming?

In a setpoint programmer you can set up a profile in the controller in which the setpoint varies in a pre-determined way over a period of time. Temperature is a very common application where it is required to 'ramp' the process value from one level to another over a set period of time.

The 2704 controller will program up to three separate profiles. These may be temperature, pressure, light level, humidity, etc., depending on the application, and are referred to as **Profiled Setpoints (PSPs)**.

The **Program** is divided into a flexible number of **Segments** - each being a single time duration, - and containing details for each profiled setpoint. The total number of segments available is **100 per program** with a **maximum of 600** for the Time to Target Programmer and **480** for the Ramp Rate programmer.

The 2704 programmer may store up to 20 programs as standard, with up to 60 if purchased.

It is often necessary to switch external devices at particular times during the program. Digital 'event' outputs can be programmed to operate during those segments.

Synchronous Programmer

In a synchronous programmer all PSPs are run on a common timebase. That is, they all start at the same time and the time duration of a segment is the same for each PSP. This is shown in Figure 31.

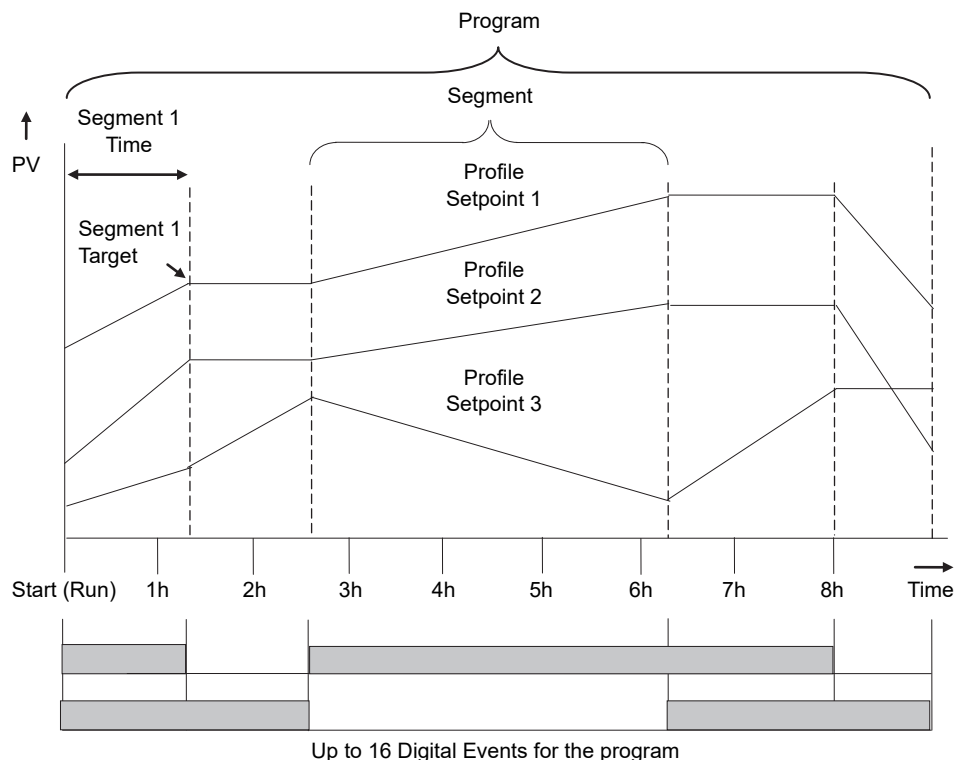

Figure 31 An Example of a Synchronous Setpoint Program

Asynchronous Programmer

In an asynchronous programmer up to three PSPs can be run with a different number of segments, based on an independent time base. Each PSP can start at the same time or can be started individually.

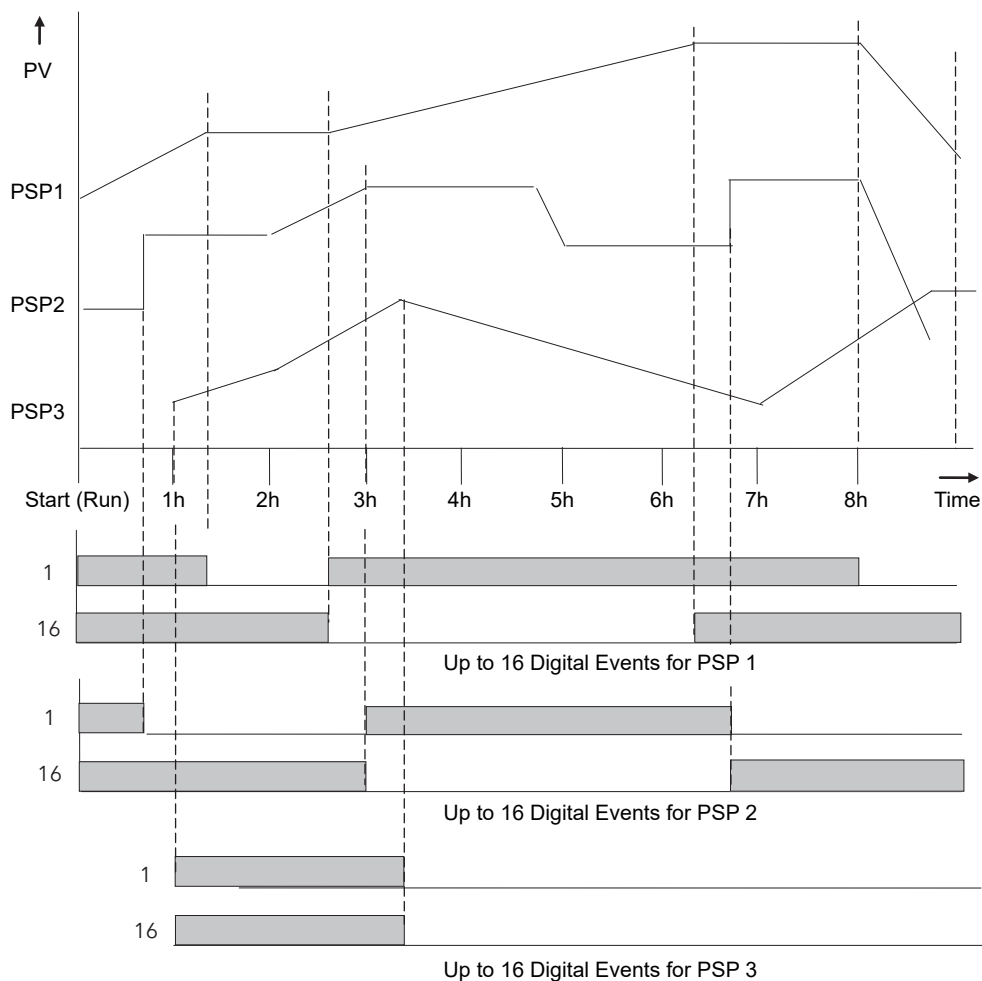

Figure 32 An Example of an Asynchronous Setpoint Program

The configuration and operation of the synchronous programmer is described in the first part of this chapter; the configuration and operation of the asynchronous programmer is described in the last part of this chapter where it differs from the synchronous programmer.

Setpoint Programmer Definitions

This section defines the more common parameters to be found when running a 2704 programmer /controller.

Run

In run the programmer varies the setpoint in accordance with the profile set in the active program.

Hold

In hold the programmer is frozen at its current point. In this state you can make temporary changes to program parameters such as a target setpoint, ramp rates and dwells (if programmer configured for ramp rate) or segment duration (if programmer configured as Time to Target). Such changes will only remain effective until the end of the currently running segment, when they will be overwritten by the stored program values.

Reset

In reset the programmer is inactive and the controller behaves as a standard controller, with the setpoint determined by the raise/lower buttons.

Servo

Servo can be set in configuration so that when a program is run the setpoint can start from the initial controller setpoint or from the current process value. Whichever it is, the starting point is called the servo point. This can be set in the program.

Servo to PV is the default and will produce a smooth and bumpless start to the process.

Servo to SP may be used in a Ramp Rate programmer to guarantee the time period of the first segment. In this case it is necessary to soft wire the Working Setpoint parameter to the PSP Reset Value parameter.

Note: In a Time to Target programmer the segment duration will always be determined by the setting of the Segment Duration parameter.

Hot Start

When run is initiated Hot Start allows the program to automatically advance to the correct point in the profile which corresponds to the operating value of the process. It can occur in any segment type, for any PSP but is most useful to ramp segments. Hot start is enabled in configuration level and specifies which programmed variable to use when deciding the correct segment.

Programmer Types

The programmer can be configured as **Time to Target** or **Ramp Rate**. A time to target programmer requires fewer settings and is simple to use since all segments are the same. A time to target programmer can, in general contain more segments than a ramp rate.

Time To Target Programmer

Each segment consists of a **single duration parameter** and a set of **target values** for the profiled variables.

1. The **duration** specifies the time that the segment takes to change the profiled variables from their current values to the new targets.
2. A **dwell** type segment is set up by leaving the target setpoint at the previous value.
3. A **Step** type segment is set up by setting the segment time to zero.

Ramp Rate Programmer

Each segment can be specified by the operator as **Ramp Rate, Dwell or Step**.



1. Each profiled setpoint must complete its segment before the programmer will move to the next segment. If one ramp reaches its target setpoint ahead of the other variables, it will dwell at that value until the other variables have completed. The program will then move to the next segment.
2. The duration parameter for a segment is read only. In this case the dwell period can be changed when the program is in Hold.
3. The duration is determined by the longest profile setting.

Segment Types

A segment type can be defined as **Profile, Go Back To** or **End**.

Profile

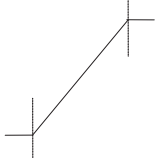
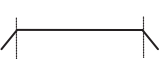
A profile segment may be set as:-

Ramp		<p>The setpoint ramps linearly, from its current value to a new value, either at a set rate (called ramp-rate programming), or in a set time (called time-to-target programming). You must specify the ramp rate or the ramp time, and the target setpoint, when creating or modifying a program.</p>
Dwell		<p>The setpoint remains constant for a specified period at the specified target. When creating programs the target is inherited from the previous segment.</p>
Step		<p>The setpoint steps instantaneously from its current value to a new value at the beginning of a segment.</p>

Go Back To Segment

Go Back allows segments in a program to be repeated by a set number of times. It is the equivalent of inserting 'sub-programs' on some controllers. Figure 33 shows an example of a program which is required to repeat the same section a number of times and then continue the program.

A Go Back To segment is used to save the total number of segments required in a program and to simplify setting up. When planning a program it is advisable to ensure that the end and start setpoints of the program are the same otherwise it will step to the different levels. A Go Back To segment is defined when editing a program, see section Program Edit (Segment) Parameters.

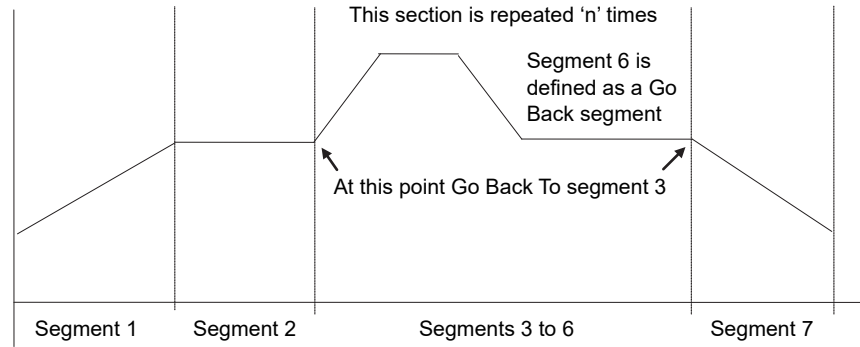

Figure 33 An Example of a Program with Repeating Section

Note: If a second or more 'Go Back' segments are created, they cannot return to a segment before the previous 'Go Back' segment as shown below.

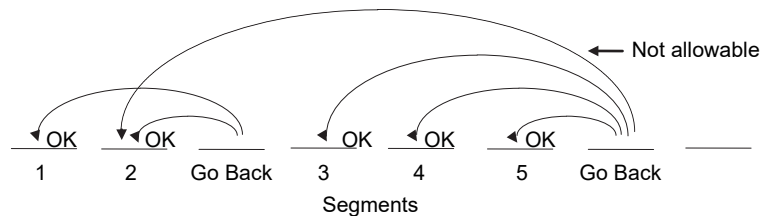

Figure 34 Permitted Go Back Segments

End Segment

The last segment in a program is normally defined as an End segment

The program either ends, repeats or resets in this segment. You specify which is the case when you create, or modify, the program. When the program ends, the programmer is put into either, a continuous dwell state with all outputs staying unchanged, or the reset state.

Wait

An event can be configured at the end of each segment, which, when active, will cause the program to wait before progressing to the next segment. Three wait conditions are provided which may be wired, in configuration level, to an external source using digital inputs or to internal sources, e.g. a loop alarm. Each segment may then select No-Wait, Wait on Event A, Wait on Event B or Wait on Event C. In a synchronous programmer the program will not proceed until all profile segments are complete.

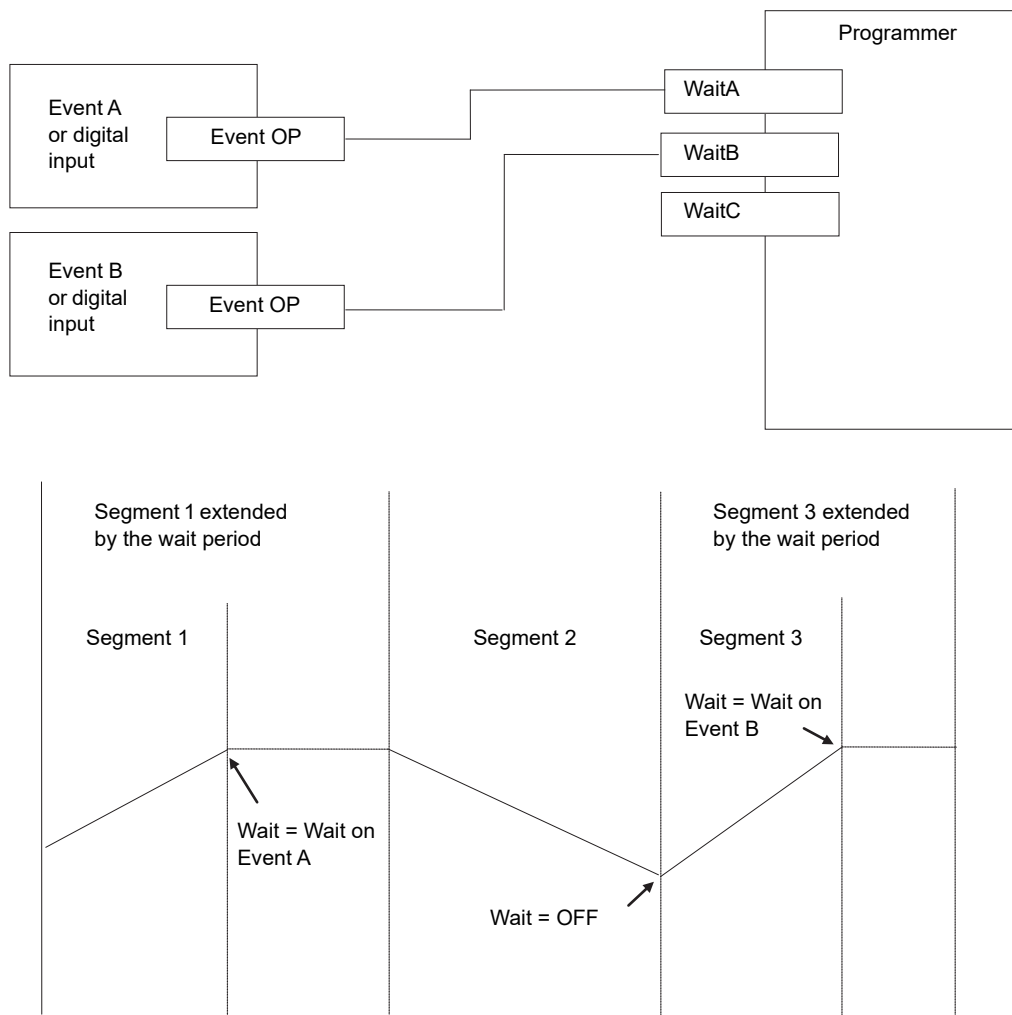

Figure 35 Wait Events

Power Fail Recovery

In the event of power fail to the controller, a strategy may be set in configuration level, which defines how the controller behaves on restoration of the power. These strategies include:

Continue	<p>The program runs from the last setpoint. This may cause full power to be applied to the process for a short period to heat the process back to its value prior to the power failure</p>	
Ramp back	<p>The PV will ramp back to its original value at the rate last encountered.</p> <p>In a Dwell segment, the period continues when the PV recovers to the SP value. The power fail time + the recovery time is added to the dwell time set.</p>	
	<p>A special case exists if no ramps have been encountered. The diagram shows the behaviour following a power fail in segment 3.</p>	
Reset	<p>The process is aborted by resetting the program</p>	
Hold Program	<p>The programmer will enter the HOLD state. The operator may then change the state to Reset or Run. On exiting from Hold into Run the program will continue, it will not ramp back.</p>	
Test Time	<p>This option makes use of the real time clock in the controller to determine how long the power has been off. Two time periods can be set which allows three strategies:</p> <ol style="list-style-type: none"> 1. If the power is off for less than the first period, the programmer will continue from its last operating point 2. If the power is off for a time between the two time boundaries, the controller will servo to the PV and ramp back to the operating point using the previous ramp rate. 3. If the power is off for longer than the second time boundary, the programmer will reset. <p>☺ The programmer takes about 25 seconds to start running after power is applied to the 2704. This delay should be taken into consideration when setting up the Test Time recovery parameter.</p>	

Holdback (Guaranteed Soak)

Holdback freezes the program if the process value does not track the setpoint by an amount which can be set by the user. It may operate in any PSP type.

In a Ramp it indicates that the process value is lagging the setpoint by more than a settable amount and that the program is waiting for the process to catch up.

In a Dwell it will freeze the dwell time if the difference between SP and PV exceeds settable limits.

In both cases it guarantees the correct soak period for the product.

Holdback may be configured in three modes:

- OFF - holdback does not operate
- Applied to the complete program. Holdback operates the same way in every segment
- To each individual segment. A different holdback type can be applied to each segment

Holdback Type defines how holdback operates. It may apply when:

- The PV is below the SP by a pre-set value (Lo),
- The PV is above the SP by a pre-set value(Hi)
- The PV is below or above the SP by a pre-set value (Band).

In addition two levels of holdback are available per profile setpoint, per program. These are defined as 'Fine' and 'Course'.

Example:

Holdback, operating in each segment, is often used in a temperature control application as detailed below:-

During a ramp up period the holdback type may be set to deviation low. If the Process Value lags the programmed rate of rise, holdback will stop the program until the PV catches up. This prevents the set program from entering the next segment until the PV has attained the correct temperature.

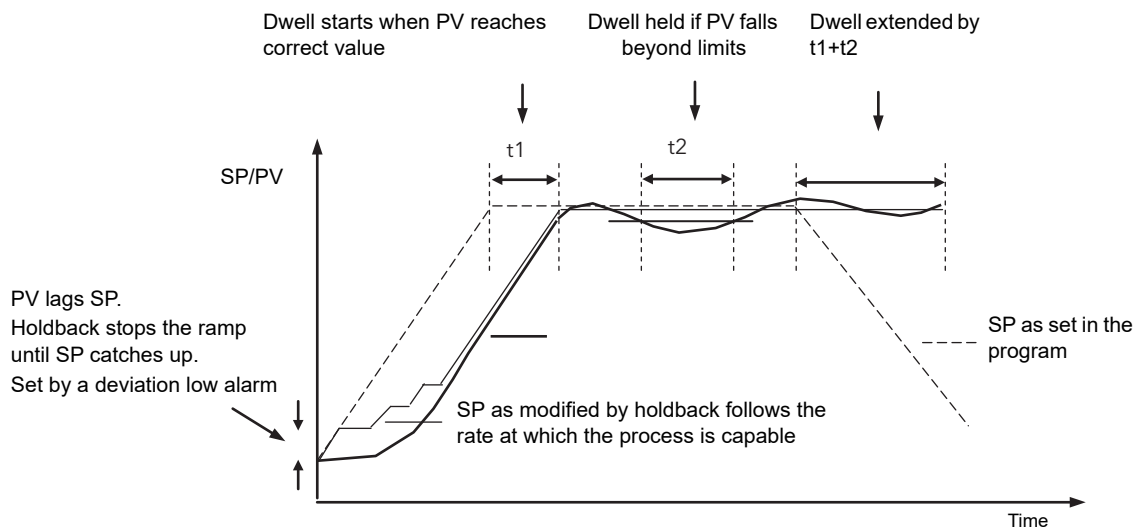

Figure 36 Effect of Holdback to Produce Guaranteed soak

During a dwell period the holdback type may be set to deviation band. This guarantees that the dwell or soak period operates only when the process value is within both high and low deviation limits.

During a ramp down period the holdback type may be set to deviation high. If the process cannot cool at the rate set by the ramp down rate the program will be held until the process catches up.

When a profile is placed into holdback the other profiles are (normally) not held. They continue and rendezvous at the end of the segment.

Each segment may consist of up to three profiles. Two levels of holdback value, course and fine, may be applied for each profile of each segment in the PROGRAM EDIT Program page.

Program User Values

Program User Values provide multiplexor facilities for the user. Each user value provides storage for a number of event values (currently 127). Each user value will normally be soft wired (see Soft Wiring) to call up another feature.

The following example shows how the programmer user values may be used to call up different sets of pre-configured digital output values for different segments in a programmer. This would make use of the Pattern Generator described in Advanced Functions, and assumes that a user value has been wired to a Pattern Generator.

Program Segment 1	Program Segment 2	Program Segment 3	Program Segment x
User Value 1 Value 1	User Value 1 Value 6	User Value 1 Value 11	User Value 1 Value 15
Pattern Generator output 1	Pattern Generator output 6	Pattern Generator output 11	Pattern Generator output 15

In each segment a different pattern of digital outputs is set up from the single value set in the User Value for each segment.

Program User Value Enumerations

Each program user value may be allocated a name chosen from the 'User Text' library, see section User Text Examples. This means that a name can be allocated to Value 1 to Value x in the above table, and can be used to describe the functions carried out in each segment. For example, if User Value 1 is called 'Carburise' the Pattern Generator will set the digital pattern required for carburising and this message can be made to appear in the PATTERN GEN (Dig Group x) page during that segment.

Section Custom Enumerations shows an example which shows how to apply an Enumeration to a Programmer User Value.

External Program Inputs

Digital inputs may have been configured to allow the program to be operated by external sources.

Run	Allows the program to be run from a pushbutton or other event
Hold	Allows the program to be held from a switch or other event.
Reset	Allows the program to be reset from a pushbutton or other event.
Run/Hold	Allows the program to be run or held from a single external source
Run/Reset	Allows the program to be run or reset from a single external source
Advance Segment	Selects the next segment from an external source
Advance Program	Selects the next program from an external source. When this event occurs, the controller display will change to programmer view. Subsequent changes of this source will cause the program number to increment.
Holdback disabled	Disables holdback from an external source

Profile Lock

Profile Lock is a configuration parameter found in the PROGRAM EDIT (Options Page) which allows programs to be created but which prevents them from being changed in operation levels.













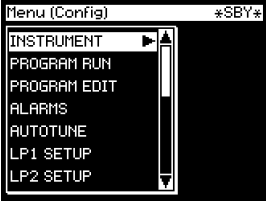



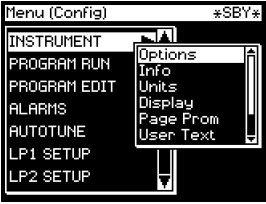

If more than one program was created prior to 'Profile Lock' being selected, then the user can select these programs (using 'Program Number') but cannot create any more.

The options are:-

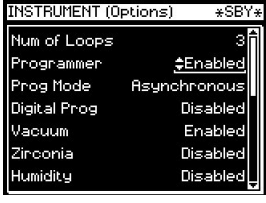
Fully Locked	No parameter or the profile can be changed in operation levels
Profile Locked	The profile of the program is locked but changes can be made to certain parameters such as Target setpoints, rates, dwells or segment duration.

Example: To Configure a Synchronous Programmer

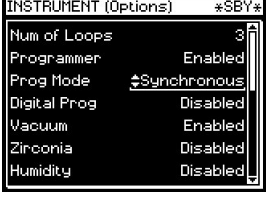
If the instrument has been supplied as a programmer it will only be necessary to complete this step if the programmer feature has subsequently been disabled or it is required to change from a synchronous to asynchronous programmer:

Do This	This Is The Display You Should See	Additional Notes
<ol style="list-style-type: none"> From any display press  to access the page header menu. Press  or  to select 'INSTRUMENT' 		
<ol style="list-style-type: none"> Press  to display sub-headers Press  or  to select 'Options' (if necessary) 		
<ol style="list-style-type: none"> Press  to display parameters Press  to scroll to 'Programmer' Press  to edit 'Programmer' Press  or  to 'Enabled' 		
<ol style="list-style-type: none"> Press  to edit 'Prog Mode' Press  or  to 'Synchronous' 		<p>It is then necessary to confirm this change since any programs already entered will be lost. Press  to confirm or  to cancel as instructed in the pop up box.</p>

Example: To Configure Synchronous Programmer Type

The programmer is supplied as a **Time to Target** programmer. This section describes how to configure a **Ramp Rate** type:

Do This	This Is The Display You Should See	Additional Notes
1. From any display press to access the page header menu. 2. Press or to select 'PROGRAM EDIT'		
3. Press to display sub-headers 4. Press or to select 'Options' (if necessary)		
5. Press to display parameters 6. Press again to select 'Program Type' 7. Press or to select 'Ramp Rate'		<p>If programs have already been set up using the previous Program Type all segment data will be deleted and will need to be re-entered in Operation level.</p> <p>The Program Type requires a few seconds to re-configure during which time 'INITIALISING' is displayed.</p>
8. Confirm or reject as instructed	 If no button is pressed for 10 seconds the display reverts to the previous view.	<p>The Program Type is then confirmed</p>

The following table lists further parameters in this page ↓↓

Program Edit Options Page

Table 7: These parameters allow you to configure Program Type and Options. Press to select each parameter. This table is only available in Configuration Level			PROGRAM EDIT (Options Page)
Parameter Name	Parameter Description	Value	Default
Program Type	See previous section		
Num of PSPs	Number of programmer setpoints	1, 2 or 3	
Prog Usr Val1?	Allows programmer User Value 1 to be enabled.	No Yes	No
UVal1 Low Lim ⁽¹⁾	User value 1 low limit	0 to 127 Limited by Uval1 Hi Lim	Only shown if Prog Usr Val = Yes
UVal1 Hi Lim ⁽¹⁾	User value 1 high limit	0 to 127	
Usr Val1 Name ⁽¹⁾	Name from user text for programmer user value 1	01:Usr1 to 100:Usr100	Default Text
Usr Val1 Enum ⁽¹⁾	First user string from for programmer user value 1 custom enumeration	01:Usr1 to 100:Usr100	Default Text
Prog Usr Val2?	Allows programmer User Value 2 to be enabled.	No Yes	No
Uval1/2 Low Lim ⁽¹⁾	User value 1/2 low limit	0 to 127 Limited by Uval1/2 Hi Lim	Only shown if Prog Usr Val = Yes
Uval1/2 Hi Lim ⁽¹⁾	User value 1/2 high limit	0 to 127	

Table 7: These parameters allow you to configure Program Type and Options. Press  to select each parameter This table is only available in Configuration Level			PROGRAM EDIT (Options Page)
Parameter Name	Parameter Description	Value	Default
Usr Val2 Name ⁽¹⁾	Name from user text for programmer user value 2	01:Usr1 to 100:Usr100	Default Text
Usr Val2 Enum ⁽¹⁾	First user string from for programmer user value 2 custom enumeration	01:Usr1 to 100:Usr100	Default Text
Wait Events?	Activates the Wait events option	No / Yes	
Hot Start	Activates the hot start option	No / Yes	
Recovery Type	Defines the power recovery strategy See also Section Power Fail Recovery	Ramp Back Reset Continue Hold Test Time	Continue
Pwr Fail Msg?	Power fail message enable This message can be inhibited following a power fail when running a program.	Yes - power fail message appears at power up and requires to be acknowledged.	Yes
		No - the message is not displayed at power up. The instrument continues to apply the configured power fail recovery strategy.	
Reset Time	Power recovery reset time (Only if 'Recovery Type' = 'Test Time')	0:00:00 to 23:59:59	
Servo Time	Power recovery servo time (Only if 'Recovery Type' = 'Test Time')	0:00:00 to 23:59:59	
Num of Prg DOs	Defines the number of digital event outputs used	None to 16	
Named Dos?	Allows names to be allocated to digital event outputs	No Yes	No
DO1 Name	To allocate a name for digital event output 1 from User Text This parameter only appears if 'Named Dos?' = 'Yes'	User Text 1 to 100	Default Text
The above parameter is repeated for every digital event output configured			
PSP1 Units	Units to be displayed for PSP1	See Appendix D.2.	
PSP1 Resol	PSP1 decimal point resolution	XXXXX XXXX.X XXX.XX XX.XXX X.XXXX	
PSP1 Low Lim	PSP1 low limit	Display range	
PSP1 High Lim	PSP1 high limit	Display range	
PSP1 Reset Val	Safe state target setpoint	Prog SP lo lim - Prog SP hi lim	
PSP1 Rate Res	PSP1 Rate Resolution	XXXXX XXXX.X XXX.XX XX.XXX X.XXXX	
PSP1 Name	To choose a name for PSP1 from user text	Default Text to 100:User100	Default Text
The above parameters are repeated for PSP2 and PSP3 if 'Num of PSPs' = 2 or 3			
Profile Lock	Prevents a program from being selected See also section Profile Lock	Unlocked Profile Locked Fully Locked	
	The program mimic page may be turned off or configured to appear in the Main Menu or in the Summary Page	Off Main Page Summary Page	

Note (1) - Parameters only available if the relevant User Value = 'Yes'

Programmer Wiring

Programmer Function Block

The programmer function block, shown in Figure 37, shows an example of soft wiring to other functions. The connections can be made using the copy and paste method described in Section Configuration of the Simple PID Loop with the exception of the Prg.DO1 to Prg.DO16 event outputs. These can be found by searching through the list of parameters or by entering the Modbus address directly. The Modbus addresses for these parameters are 05869 to 05883 inclusive.

The parameters which can be wired are listed in Figure 37. These parameters can be wired to any other parameter by Modbus address or using the shorter list of parameter names – Appendix D.

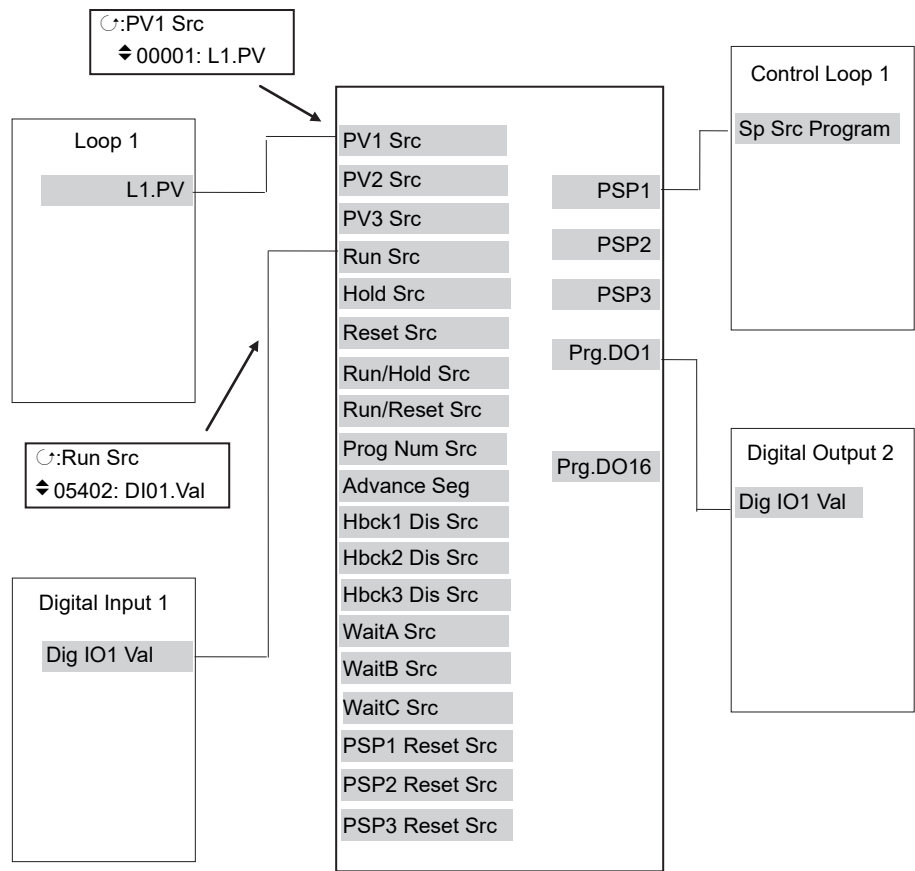



Figure 37 Programmer Function Block and Wiring Example

PROGRAM EDIT Wiring Page

Table 8: These parameters allow you to soft wire programmer functions This table is only available in Configuration Level		PROGRAM EDIT (Options Page)
Parameter Name Press  to select	Parameter Description	Default Modbus Address: Parameter Mnemonic
PV1 Src	PV 1 source	00001:LP1 PV
PV2 Src	PV 2 source	01025:LP2 PV
PV3 Src	PV 3 source	02049:LP3 PV
Prog Num Src	Program number source	Note 2
Run Src	Run source	05494
Hold Src	Hold Source	05642
Reset Src	Reset Source	05690
Run/Hold Src	Run/Hold Source	Note 2
Run/Reset Src	Run/Reset Source	Note 2
Advanc Prg Src	Advance Program source	Note 2
Advanc Seg Src	Advance segment source	12609
FineHbck1 Sr	Fine holdback 1 source	Note 2
CorseHbck1	Course holdback 1 source	Note 2
Hbck1 Dis Src	Holdback 1 disable source	Note 2
FineHbck2 Sr	Fine holdback 2 source	Note 2
CorseHbck2	Course holdback 2 source	Note 2
Hbck2 Dis Src	Holdback 2 disable source	Note 2
FineHbck3 Sr	Fine holdback 3 source	Note 2
CorseHbck3	Course holdback 3 source	Note 2
Hbck3 Dis Src	Holdback 3 disable source	Note 2
WaitA Src	Wait A source	Note 2
WaitB Src	Wait B source	Note 2
WaitC Src	Wait C source	Note 2
PSP1 Reset Src	PSP1 reset source ⁽¹⁾	00001:LP1 PV
PSP2 Reset Src	PSP2 reset source ⁽¹⁾	01025:LP2 PV
PSP3 Reset Src	PSP3 reset source ⁽¹⁾	02049:LP3 PV

Note 1:

The PSP Reset Source defines the programmer starting conditions. To servo to setpoint, wire the relevant reset source into the SP. To servo to PV, wire the relevant reset source into the PV.

The value which is wired into the Reset Source is the value which appears at the programmer output.

Note 2:

By default these parameters are not soft wired.

To Create or Edit a Program















To create or edit a program it is first necessary to define the parameters associated with the overall program. These parameters will be found under the page header **'PROGRAM EDIT (Program)'**, see section Program Edit (Program Page) Parameters.

Then set up the parameters which define each individual segment. These parameters will be found in the page **'PROGRAM EDIT (Segments)'**, see section Program Edit (Segment) Parameters.

Notes:

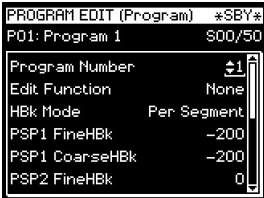
1. A running program cannot be edited, it must be put into Reset or Hold mode.
2. Changes can be made to any segment of a currently running program as follows:
 - To the currently running segment - use the PROGRAM RUN page. These changes are always temporary and apply to the current run only
 - To any segment - use the PROGRAM EDIT page. These changes are always permanent and will apply to subsequent runs.
3. Other programs can be created or edited when another program is running.
4. A program can be edited in Configuration Level or Operating Level

Example: To Access The Program Edit Pages

Do This	This Is The Display You Should See	Additional Notes
1. From any display press  to access the page header menu. 2. Press  or  to select 'PROGRAM EDIT'		
3. Press  to show sub-headers 4. Press  or  (if necessary) to select 'Program'		This page allows the overall programmer parameters to be defined
5. Press  to show parameters 6. Press  again to edit the highlighted parameter		The value of a parameter prefixed by  can be changed using  or  The full list of parameters is shown in the following table

Program Edit (Program Page) Parameters

Table 9: These parameters affect the overall program.				PROGRAM EDIT (Options Page)
Parameter Name	Parameter Description	Value	Default	Access Level
Program Number	Selects the program number to be edited. If 'Profile Lock' ≠ 'Unlocked', only those programs which were created prior to setting the 'Profile Lock' parameter can be selected.	1 to 20 or 1 to 60	1	L1
Edit Function	Allows a program to be copied. The example in section Example: To Insert a Segment Into a Program describes how this feature is used	None Copy Program Paste Program	None	L1
Hbk Mode	Holdback mode None = no holdback Per prog = applied over the whole program Per seg = active in every segment	None Per Program Per Segment	None	L1
PSP1 HBk Type	Holdback type for PSP1 (per program) These are deviations between SP and PV Fine and course holdback allows two levels of holdback to be applied to different segments, see section Fine and Coarse Holdback.	Off Fine Lo Fine Hi Fine Band Course Lo Course Hi Course Band	Off	L1 Only displayed if Per Program configured
PSP1 FineHbk	Fine holdback value for <i>PSP1</i>	Display Range	0	L1 Only shown if
PSP1 CourseHbk	Course holdback value for <i>PSP1</i>	Display Range	0	HBk Type ≠ Off
The above three parameters are repeated for <i>PSP2</i> and for <i>PSP3</i> if these are configured				
Hot Start PSP	Allows hot start to be applied to each PSP. See also section Hot Start	None <i>PSP1</i> <i>PSP2</i> <i>PSP3</i>	None	L1
Rate Units	Rate units for a Ramp Rate Programmer	Per Second Per Minute Per Hour		L1. Only displayed if the programmer is Ramp Rate
Program Cycles	The number of times a program repeats.	Cont. to 999	Cont.	L1
End Action	Defines the action in the end segment. Dwell - the program will dwell indefinitely at the conditions set in the end segment. Reset - the program will reset to the start conditions.	Dwell Reset		L1
Program Name	Allows a user defined name to be given to the program number	User string Each character can be set in turn		L1

Fine and Coarse Holdback

Fine and Coarse Holdback values are only displayed when 'Holdback Mode' = 'Per Segment'. They allow you to apply one value of holdback to selected segments and another value to other segments. For example, you could apply 'Fine Holdback' to one or more Dwell segments and 'Coarse Holdback' to one or more Ramp segments

The segments in which Fine and Coarse Holdback are applied are selected in '**PROGRAM EDIT (Segments)**'.

Example: To Set Up Each Segment of a Program

Do This	This Is The Display You Should See	Additional Notes
1. From any display press to access the page header menu. 2. Press or to select 'PROGRAM EDIT'		
3. Press to show sub-headers 4. Press or (if necessary) to select 'Segment'		
5. Press to select the segment parameters 6. Press or to scroll up or down the list of parameters. 7. Press again to edit the parameter. The value or state of a parameter prefixed by can be changed using or	<p style="text-align: center;">If the program is new, confirm as instructed on the display</p> <div style="border: 1px solid black; padding: 5px; width: fit-content; margin: 0 auto;"> Create Prg: 2? <input type="checkbox"/> → Cancel <input type="checkbox"/> → OK </div> <p style="text-align: center;">If the program exists, the segment details are displayed</p> <p style="text-align: right;">Up to 100 segments are available per</p>	



A back and forward scroll is available by holding down and pressing or respectively

Further parameters may be accessed and adjusted in the same way. These are listed together with an explanation of their function in the following table ↓↓

Program Edit (Segment) Parameters

Table 10: These parameters allow you to set up each segment in the program			PROGRAM EDIT (Segment)	
Parameter Name	Parameter Description	Value	Default	Access Level
Program Number	Selects the program number to be edited	1 to 20 (or 60)		L1
Segment Number	Selects the segment number to be edited	1 to 100		L1
Edit Function	Allows a segment to be inserted The example in section Example: To Insert a Segment Into a Program describes how this feature is used	None Insert Segment Delete Segment	None	L1
Segment Type	Segment type	Profile End Segment Go Back	Profile	L1
Profile = a normal segment End Segment = the last segment in the program (press to confirm) Go Back = repeat part of program. Not shown for segment 1.				
PSP1 Type	Profile setpoint 1 type	Step Dwell Ramp		L1
Only shown if Program Type = Ramp Rate and program not in End				





Table 10: These parameters allow you to set up each segment in the program			PROGRAM EDIT (Segment)	
Parameter Name	Parameter Description	Value	Default	Access Level
PSP1 Target	Profile setpoint 1 target value	SP1 lo limit to SP1 hi limit	0	L1
PSP1 Dwell Tm	Profile setpoint 1 dwell time Only shown if Program Type = Ramp Rate; Segment Type = Dwell and program not in End	d : h : m : s		L1
PSP1 Rate	Profile setpoint 1 rate Only shown if Program Type = Ramp Rate; Segment Type = Dwell and program not in End			L1
PSP1 Hbk Type	Profile setpoint 1 holdback type	Off Fine Lo Fine Hi Fine Band Course Lo Course Hi Course Band	Off	L1

The above five parameters are repeated if *PSP2* and *PSP3* are configured

Seg Duration	Duration for Time to Target programmer only	d : h : m : s		L1
Wait Event	Wait if selected event is true Only shown if wait events configured	No wait Event A Event B Event C	No Wait	L1
Prog User Val 1	Allows a Programmer User Val to be chosen. See also section Program User Values. Only shown if Prog User Val 1 is configured	0 to 100	0	L1
Prog User Val 2	Allows a Programmer User Val to be chosen. See also section Program User Values. Only shown if Prog User Val 2 is configured	0 to 100	0	L1
Prog DO Values	Sets programmer event outputs on or off. The number of DO values is set by 'Num of Prog DOs' PROGRAM EDIT (Options) Not shown if Num of Prog Dos = 'None'	<input type="checkbox"/> <input type="checkbox"/> <input type="checkbox"/> ■ = Off □ = On		L1
Seg Edit 1 (to 16)	If programmer event outputs have been configured, then, as an alternative to the previous presentation, the event can be given a name. [PROGRAM EDIT (Options) – Named Dos? = Yes]	The name of the event is shown with its state On or Off	Off	L1
GoBack to Seg	Allows repeat segments to be set up within a profile. Go back defines the point in the program where the repeat segments are entered. Only shown if segment. type is Go Back	1 to no. of segments See also Section Go Back To Segment.		L1
Go Back Cycles	Sets up the number of times the segments are repeated Only shown if segment. type is Go Back	1 to 999	1	L1
Segment Name	Allows a user defined name to be chosen	Default Text to 100:Usr 100	Default Text	L1

To Run a Synchronous Program

Press . A program can only be Run, Reset or Held in Operator Level 1, 2 or 3.

1. The program status pop up window is displayed
2. Press  or  to select the program to be run
3. Press  to edit Delayed Start if it is required to run the program after a set period
4. Press  or  to set a time period for the delayed start
5. Press the PROG button again to select 'Run'



The symbol in the top left of the display changes to .

To Hold a Program

A program can only be held from Run mode. Press the 'PROG' button once. The pop up window is again displayed showing 'Run'. Press the 'PROG' button again. The message in the pop up window changes to 'Hold'.

The symbol in the top left of the display changes to .

To Reset a Program

Press the 'PROG' button once. The pop up window is again displayed showing 'Run' or 'Hold'. Press the 'PROG' button again and hold it pressed for 2 seconds. The message changes to 'Reset'.

The symbol in the top left of the display changes to .

From Digital Inputs

If digital inputs have been configured and wired for an external RUN, HOLD or RESET, activate the relevant digital input. This will normally be activated from an external switch.

From Digital Communications

If a PC running SCADA package or iTools is connected to the controller via the digital communications module, the programmer status may be changed from this package.

From the PROGRAM RUN Page

This page contains a parameter called 'Program Status'. Its value can be changed to 'Run', 'Hold' or 'Reset'. See the following section.

Example: To View The State of a Running Program

If you wish to know the state of the digital outputs or times remaining, for example, then you can access the 'PROGRAM RUN' pages:

Do This	This Is The Display You Should See	Additional Notes
1. From any display press to access the page header menu. 2. Press or to select 'PROGRAM RUN'		
3. Press to show sub-headers 4. Press or (if necessary) to select 'General'		
5. Press to select the list of parameters for running the program.		The parameters in this view include: <ul style="list-style-type: none"> • Program Status – Run Hold or Reset can be selected from this list • Current segment • Program event outputs • Time & Days remaining to end of program • Fast Run

WARNING

Fast Run allows the program to be tested by quickly running through the program segments. If the controller is connected to the process, ensure that the process is not affected if fast run is selected.

The default value, **No**, means that the program will run at the set rate

The full list of parameters is shown in the following table

Run Parameter Tables

Table 11: These parameters provide information on the running program.		PROGRAM RUN (General Page)		
Parameter Name	Parameter Description	Value	Default	Access Level
Prog DOs	Digital outputs summary These are shown in this format if 'Named Dos' = 'No' The number of DO values is set by 'Num of Prog DOs' PROGRAM EDIT (Options) Not shown if Num of Prog DOs = 'None'	<input type="checkbox"/> <input type="checkbox"/> <input type="checkbox"/> (Up to 16) ■ = Off □ = On		L3
Prog DO 1 (to 16)	If programmer event outputs have been configured, then, as an alternative to the previous presentation, the event can be given a name. [PROGRAM EDIT (Options) – Named Dos? = Yes]	The name of the event is shown with its state On or Off	Off	L3
Delayed Start	Delay before the start of the program	h:mm:ss	0:00:00	L3
Time Remaining	Time remaining to end of program	Not Running or h:mm:ss		L3
Days Remaining	Number of days left for the programmer to run	0 to 255	No	L3
Program Status	Displays the status of the program	Reset Run Hold Complete		L1

Table 11: These parameters provide information on the running program.		PROGRAM RUN (General Page)		
Parameter Name	Parameter Description	Value	Default	Access Level
Prog Run	Programmer run status	1=running		L3
Prog Hold	Programmer hold status	1=holding		L3
Prog Reset	Programmer reset status	1=reset		L3
Prog End	Programmer end status	1=end		L3
New Seg	New segment loaded	1=new segment for 100ms		L3
Prog Time Elap	Program time elapsed	h: mm: ss	up to 24Hrs	L3 R/O
Prog Cycle Rem	Remaining number of cycles Only if 'Prog Cycles' >1	1 to 999		L1 R/O
Total Segments	Number of segments in the running program	0 to 100		L1 R/O
Segment Number	The currently running segment number	1 to 100		L1 R/O
Segment Type	Current segment type Profile = normal segment End Segment = End of prog Go Back =repeat part of prog	Profile End Segment Go Back	Profile	L1 R/O Alterable in Hold
Segment Name	A user defined name for the segment	User Text	Default Text	L1 R/O
Seg Time Rem	Time remaining in the current segment	d: h: m: s		L1. R/O Alterable if Time To Target prog and in Hold
Wait Status	Wait Status	No Wait Event A Event B Event C	No Wait	L1 R/O
Wait Condition	Wait condition for the running segment	No Wait Event A Event B Event C	No Wait	L1. Alterable in Hold
Prog User Val 1	Active User Val 1			L1
Prog User Val 2	Active User Val 2			L1
Goback Rem	Go back cycles remaining	1 to 999		L1 R/O
End Action	The state required in the end segment	Dwell Reset		L1 R/O
Prog Reset DO	Digital event outputs in Reset These are shown in this format if 'Named Dos' = 'No'	<input type="checkbox"/> <input type="checkbox"/> <input type="checkbox"/> <input type="checkbox"/> (up to 16) ■ = Off □ = On		L1 R/O Only shown if configured
Seg Edit 1 (to 16)	If programmer event outputs have been configured, then, as an alternative to the previous presentation, the event can be given a name. [PROGRAM EDIT (Options) – Named Dos? = Yes]	The name of the event is shown with its state On or Off	Off	L3
Reset UsrVal1	Reset value for User Value 1			L1
Reset UsrVal2	Reset value for User Value 2			L1
Seg Time Rem	Segment time remaining	h:m:s		L1
PSP1 Type	Running segment type for profiled setpoint 1	Not Used Step Dwell Ramp		L1 R/O - shown in Ramp Rate programmer only
PSP1	Working setpoint for profiled setpoint 1	Display range (Note 1)		L1. Alterable in Hold
PSP1 Target	Running segment target for profiled setpoint 1	Display range (Note 1)		L1. Alterable in Hold
PSP1 Dwell Tm	Time remaining in running segment for profiled setpoint 1	Display range		L1. Alterable in Hold
PSP1 Rate	Running segment rate for profiled setpoint 1	Display range (Note 1)		L1. Not in Time To Target prog
PSP1 HBk Appl	Holdback applied for profiled setpoint 1	No Yes		L1 R/O - shown if configured

Note 1: Range limited by user defined upper and lower limits

The above table is repeated for PSP2 parameters and PSP3 parameters

Programmer Wiring Examples

One Profile, Three Loops

This example explains how to configure a programmer to allow one profile to generate a setpoint for three control loops.

The 2704 program block can generate up to three profiled variables, which can then be internally wired to any parameter source. In most cases the PSPs are used to allow control loop setpoints to follow a pre-determined ramp/dwell sequence, but they can also be used, for example, to retransmit a setpoint to a slave device.

In this example PSP1 is soft wired to the program setpoints of each control loop. Also, the PV of loop1 is wired to the PV1 source, to provide holdback, and the PSP1 reset source, to provide servo start. This configuration is supplied from the factory by defining the hardware code field, in the 2704 order code, for loops/programs to be '321' or '351'.

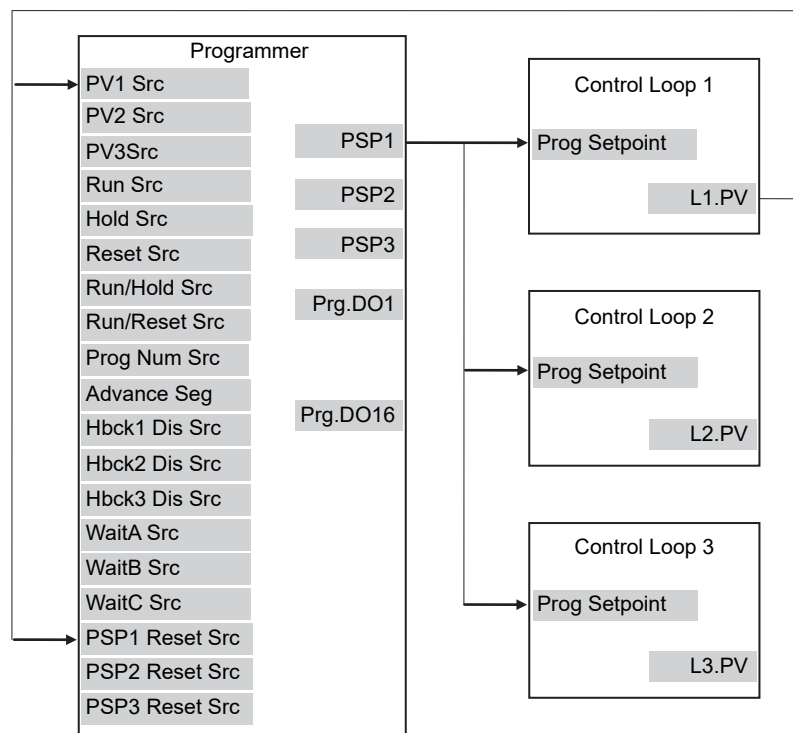

Figure 38 Example Programmer Wiring One Profile Three Loops

Implementation

1. In INSTRUMENT/Options Page
 - set 'Num of Loops' = 3
 - set 'Programmer = Enabled
2. In PROGRAM EDIT/Options Page
 - set 'Num of PSPs' = 1
 - (Note: other parameters such as number of digital event outputs, SP range and power failure recovery are also set in this page)
3. In PROGRAM EDIT/Wiring Page
 - Set 'PV1 Src' = 00001:L1.PV
 - This connection is required so that the programmer can use Loop 1 PV to calculate holdback.

- 4. In PROGRAM EDIT/Wiring Page Set 'PSP1 Reset Src' = 00001:L1.PV
This connection is required so that the programmer can use Loop 1 PV to servo start.
- 5. In LP1 SETUP/Options Page Set 'Prog Setpoint' = PSP1
Connects PSP1 to become the program SP for Loop 1
- 6. In LP2 SETUP/Options Page Set 'Prog Setpoint' = PSP1
Connects PSP1 to become the program SP for Loop 2
- 7. In LP3 SETUP/Options Page Set 'Prog Setpoint' = PSP1
Connects PSP1 to become the program SP for Loop 3

See Appendix D for list of Modbus addresses.

☺: See 'Copy and Paste' description in Soft Wiring.

Two Profiles, Two Loops

This example explains how to configure a 2704 programmer to generate two setpoints which are then used to profile the setpoint for two independent control loops.

In this example PSP1 and PSP2 are soft wired to the program setpoints of loop 1 and loop 2 respectively. Also, the PV of loop1 is wired to the PV1 source, to provide holdback, and the PSP1 reset source, to provide servo start. The latter is repeated for Loop 2. This configuration is supplied from the factory by defining the hardware code field, in the 2704 order code, for loops/programs to be '222' or '252'.

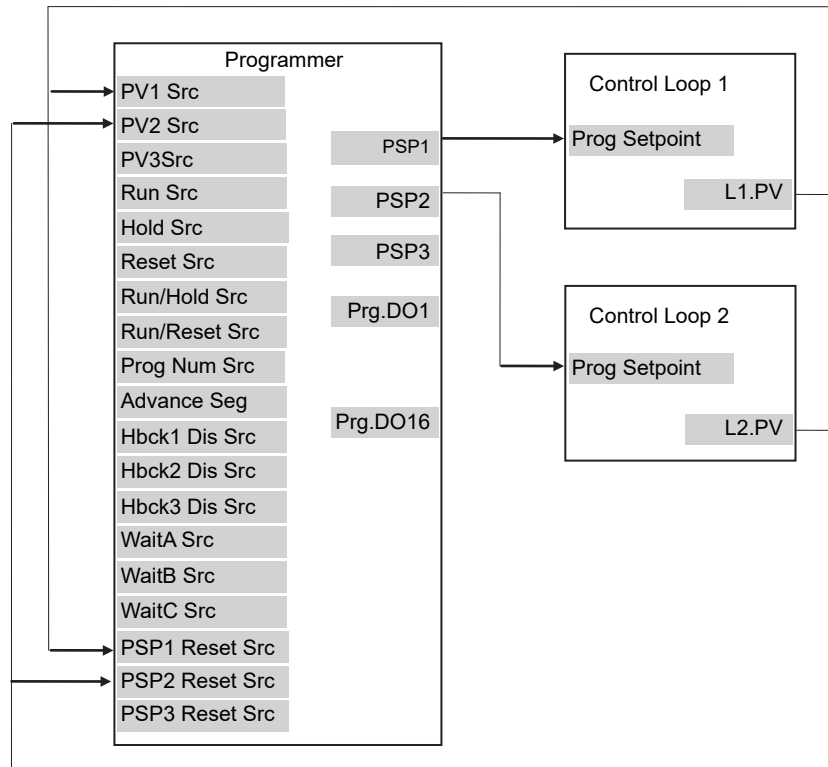

Figure 39 Example Programmer Wiring Two Profiles Two Loops

Implementation

1. In INSTRUMENT/Options Page set 'Num of Loops' = 2
set 'Programmer = Enabled'
2. In PROGRAM EDIT/Options Page set 'Num of PSPs' = 2
(Note: other parameters such as number of digital event outputs, SP range and power failure recovery are also set in this page)
3. In PROGRAM EDIT/Wiring Page Set 'PV1 Src' = 00001:L1.PV
This connection is required so that the programmer can use Loop 1 PV to calculate holdback for PSP1.
4. In PROGRAM EDIT/Wiring Page Set 'PV2 Src' = 01025:L2.PV
This connection is required so that the programmer can use Loop 2 PV to calculate holdback for PSP2.
5. In PROGRAM EDIT/Wiring Page Set 'PSP1 Reset Src' = 00001:L1.PV
This connection is required so that PSP1 can use Loop 1 PV to servo start.
6. In PROGRAM EDIT/Wiring Page Set 'PSP2 Reset Src' = 01025:L2.PV
This connection is required so that PSP2 can use Loop 2 PV to servo start.
7. In LP1 SETUP/Options Page Set 'Prog Setpoint' = PSP1
Connects PSP1 to become the program SP for Loop 1
8. In LP2 SETUP/Options Page Set 'Prog Setpoint' = PSP2
Connects PSP2 to become the program SP for Loop 2

See Appendix D for list of Modbus addresses.

☺: See 'Copy and Paste' description in Soft Wiring.

Asynchronous Programmer

A summary of the functions available in the asynchronous programmer is given below:

- Creation of programs is the same as for the synchronous programmer, thus allowing for a different number of segments for each PSP.
- The number of available programs for each PSP is fixed at 20
- Twenty Program Groups are available. Program Groups are described in section Program Groups.
- Up to three programs may be configured into each program group
- Programs in each Program group are executed asynchronously. They all start at the same time although it is possible to run, say, PSP1 and PSP2 with PSP3 not used; then run PSP3 later
- Each program can have up to 16 event outputs and two user values per segment
- The first press of the PROG button allows the user to select the program group to run
- The user may select and modify programs in the selected group when the program is in Hold or Reset mode in the same way as a synchronous programmer
- Changes made to programs, other than Group 0, are permanent
- A delayed start parameter is available
- Changes made to Program Group 0 will be overwritten by stored program combinations for other groups when one of these is selected
- The Run/Hold button acts as a global Program Group control, i.e. all programs in the program group are put into the requested state
- Individual status parameters are available for each program in the group
- There is a Group Status parameter to control the state of the active run group
- Three programmer blocks are utilised to service each Program Group
- Programs not running as part of an active group may be run under independent control, provided the programmer block is not already in use by the active Program Group

Program Groups

Up to three PSPs can be programmed into a single Program Group.

Example 1: Run Group 1

You may wish to run a Temperature program, a Pressure program and a Humidity program in a particular application. These are shown below as PSP1, PSP2 and PSP3 respectively. Each PSP program can store up to 20 profiles and each includes 16 event outputs. Any combination of these can be placed into a program group. Up to 20 program groups can be defined.

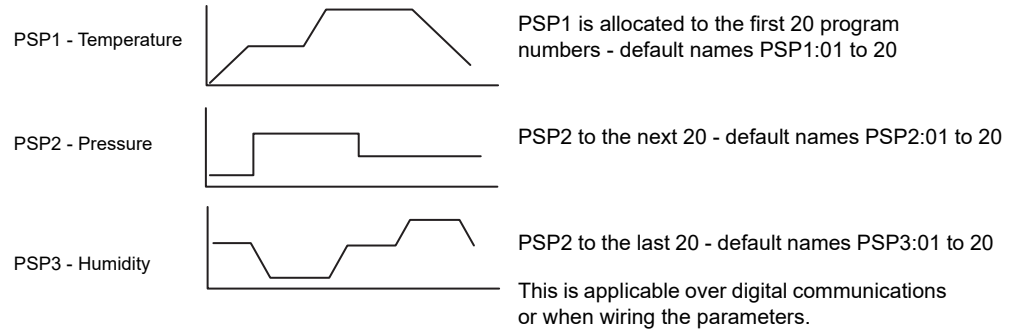

Each program can be run, held or reset individually or together as a group.

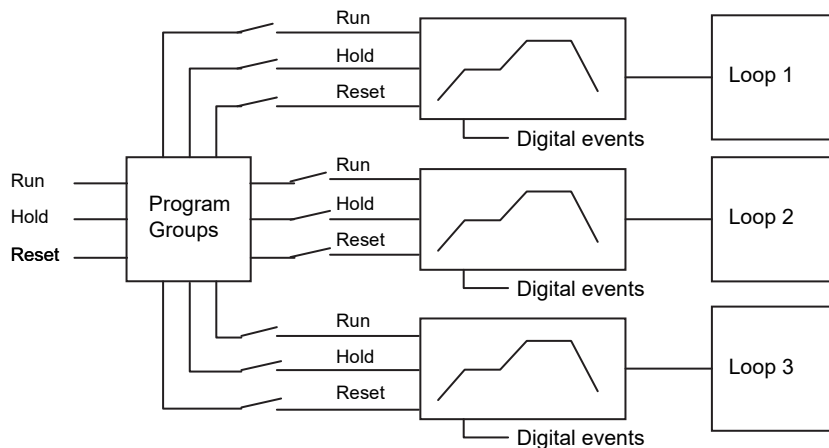





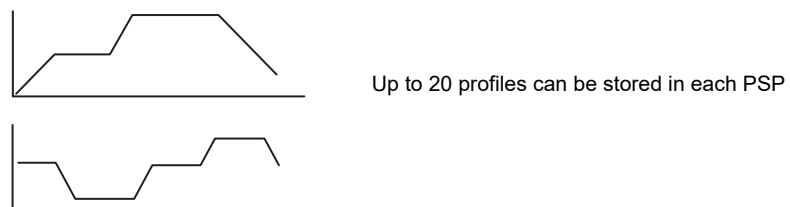











Example Run Group 2

This might consist of a Temperature Profile and a Humidity profile



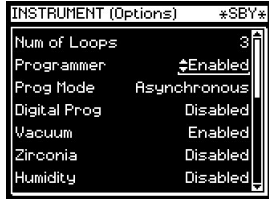



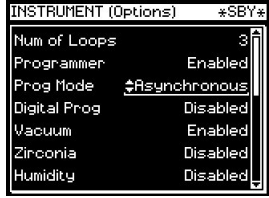





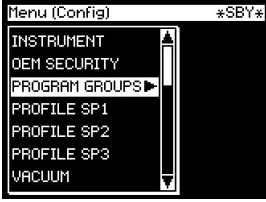

Example: To Configure an Asynchronous Programmer

If the instrument has been supplied as a programmer it will only be necessary to complete this step if the programmer feature has subsequently been disabled or it is required to change from a synchronous to asynchronous programmer:

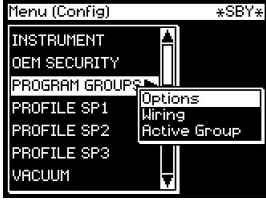
Do This	This Is The Display You Should See	Additional Notes
1. From any display press  to access the page header menu. 2. Press  or  to select 'INSTRUMENT'		
3. Press  to display sub-headers 4. Press  or  to select 'Options' (if necessary)		
5. Press  to display parameters 6. Press  to scroll to 'Programmer' 7. Press  to edit 'Programmer' 8. Press  or  to 'Enabled'		
9. Press  to edit 'Prog Mode' 10. Press  or  to 'Asynchronous'		In an Asynchronous programmer each program can run independently

Example: To Configure Asynchronous Programmer Type

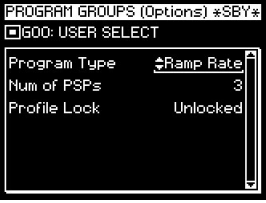
The programmer is supplied as a **Time to Target** programmer. This section describes how to configure a **Ramp Rate** type:

Do This	This Is The Display You Should See	Additional Notes
1. From any display press  to access the page header menu. 2. Press  or  to select ' PROGRAM GROUPS '		Programmer Groups is a new list added for the asynchronous programmer and configures: <ul style="list-style-type: none"> • Programmer Type • Number of programs • Hot Start • Power fail recovery type • Profile Lock
3. Press  to display sub-headers 4. Press  or  to select ' Options ' (if necessary)		for all PSPs
5. Press  to display parameters 6. Press  again to edit ' Program Type ' 7. Press  or  to select ' Ramp Rate '		<p>If programs have already been set up using the previous Program Type all segment data will be deleted and will need to be re-entered in Operation level.</p> <p>The Program Type requires a few seconds to re-configure during which time 'INITIALISING' is displayed.</p> <p>The Program Type is then confirmed</p>
8. Confirm or reject as instructed	 <p>If no button is pressed for 10 seconds the display reverts to previous.</p>	

The following table lists further parameters in this page 

Program Group Options Page

The following pages allow you to set up and configure the Program Groups. It consists of three sub-headings; the Options page is to configure the overall program; the Wiring page allows internal soft wiring to different parameters; the Active Group page allows each individual group to be set up and is available in operator level access.

Table 12: These parameters allow you to configure Program Type and Options. PROGRAM GROUPS (Options Page) This page is only available in configuration level			PROGRAM GROUPS (Options Page)
Parameter Name	Parameter Description	Value	Default
Program Type	To select the type of programmer	Time to Target Ramp Rate	Time to Target
Num of PSPs	Number of profile setpoints used	1, 2 or 3	
Profile Lock	To allow a program to be created but allows no changes in operation levels	Unlocked Profile Locked Fully Locked	Unlocked

A description of each of these parameters is given in the earlier sections of this chapter.

Program Groups Wiring Page

Table 13: These parameters allow you to configure the internal soft wiring connections for the Program Groups. This page is only available in configuration level			PROGRAM GROUPS (Wiring Page)
Parameter Name Press \odot to select	Parameter Description	Value	Default
Group Num.	Group number source	Modbus address Enter either the Modbus address directly if known or select from the list in Appendix D	----- None
Run Src	Run Source		
Hold Src	Hold Source		
Reset Src	Reset Source		
Run-Hold Src	Run-Hold Source		
Run-Reset Src	Run-Reset Source		
Group Adv.	Group advance – move to the next group		

Program Groups Group Edit Page

This page is available in operator and configuration level.

Table 14: These parameters allow you to set up individual Program Groups			PROGRAM GROUPS (Group Edit Page)	
Parameter Name	Parameter Description	Value	Default	Access Level
Group Number	To select the Group number Load Programs allows a program to be entered and run directly	'Load Programs' or select from 1 to 20	Load Programs	L1
Delayed Start	To set a time delay before the program will run	h:mm:ss	0:00:00	L3
Group Status	The program group can be controlled from this parameter The status of the program is also shown by text and symbols at the top of this display	Reset Run Hold Complete		L1
PSP1	To select the profile to be run in the group. Not Used means PSP1 is not part of the group 01:PSP1:P1 means PSP1 is selected from program 1 to 20	Not Used 01:PSP1:P1 to 20:PSP1;P20		L1
PSP2	As above			L1
PSP3	As above			L1
Group Name	A user configurable name By default if Group Number = Load Programs then Group Name = USER SELECT. To customise the name press \triangle or ∇ to change the digit with the flashing cursor. Press \odot to advance the cursor	USER SELECT Group 1 to 20	GROUP NAME	L1
Group Run	Group Run	Off On	R/O	L3 R/O
Group Hold	Group Hold	Off On	R/O	L3 R/O
Group Reset	Group Reset	Off On	R/O	L3 R/O
Group End	Group End	Off On	R/O	L3 R/O

Profile Setpoint Pages

These pages are similar to the PROGRAM EDIT page available in the synchronous programmer. They allow you to configure and set up each PSP.

There are six pages:

1. The Options page available in configuration level only. Allows configuration of overall parameters associated with the PSP such as limits, PSP names, units, etc
2. The Wiring page available in configuration level only. Allows internal soft wiring to parameters specific to the application
3. The Run General page available in Operator Level 1. Provides running information of the PSP
4. The Run Segment page available in Operator Level 1. Provides running information of each segment of the PSP
5. The Program Edit page available in Operator Level 1. Allows editing of the overall PSP
6. The Segment Edit page available in Operator Level 1. Allows editing of each segment in the PSP

PSP1 (2 or 3) Profile Options

This page is only available in configuration level

Table 15: These parameters allow you to configure parameters associated with the PSP.		PROGRAM GROUPS (Options Page)	
Parameter Name Press \odot to select	Parameter Description	Value	Default
Prog Usr Val1?	Allows programmer User Value 1 to be enabled.	No Yes	No
UVal1 Low Lim ⁽¹⁾	User value 1 low limit	0 to 127 Limited by Uval1 Hi Lim	Only shown if Prog Usr Val = Yes
UVal1 Hi Lim ⁽¹⁾	User value 1 high limit	0 to 127	
Usr Val1 Name ⁽¹⁾	Name from user text for programmer user value 1	01:Usr1 to 100:Usr100	Default Text
Usr Val1 Enum ⁽¹⁾	First user string for programmer user value 1 custom enumeration	01:Usr1 to 100:Usr100	Default Text
The above parameters are repeated for User value 2			
Wait Events?	Enables wait events	No Yes	No
Hot Start	Enables the hot start option	No Yes	No
Recovery Type	Defines the power recovery strategy See also section Power Fail Recovery	Ramp Back Reset Continue Hold Test Time	Continue
Reset Time	Power recovery reset time	h:mm:ss	
Servo Time	Power recovery servo time	h:mm:ss	
Num of Prg DOs	Defines the number of digital event outputs used	None to 16	
Named DOs?	Allows names to be allocated to digital event outputs	No Yes	No
DO1 Name	To allocate a name for digital event output 1 from User Text This parameter only appears if 'Named Dos?' = 'Yes'	User Text 1 to 100	Default Text
The above parameter is repeated for every digital event output configured			
PSP1 Units	Units to be displayed for PSP1	See Appendix D	

Table 15: These parameters allow you to configure parameters associated with the PSP.		PROGRAM GROUPS (Options Page)	
Parameter Name Press \odot to select	Parameter Description	Value	Default
PSP1 Resol	PSP1 decimal point resolution	XXXXX XXXX.X XXX.XX XX.XXX X.XXXX	
PSP1 Low Lim	PSP1 low limit	Display range	
PSP1 High Lim	PSP1 high limit	Display range	
PSP1 Reset Val	Safe state target setpoint	Prog SP lo lim to Prog SP hi lim	
PSP1 Rate Res	PSP1 rate resolution	XXXXX XXXX.X XXX.XX XX.XXX X.XXXX	
PSP1 Name	To choose a name for PSP1 from user text	Default Text to 100:User100	Default Text
Mimic Page	The program mimic page may be turned off or configured to appear in the Main Menu or in the Summary Page	Off Main Page Summary Page	

Note (1) - Parameters only available if the relevant 'User Value' = 'Yes'

PSP1 (2 or 3) Profile Wiring

This table is only available in Configuration Level

Table 16: These parameters allow you to soft wire programmer functions.		PSP1 (2 or 3) PROFILE (Wiring Page)
Parameter Name Press \odot to select	Parameter Description	Default Wiring Value Modbus Address: Parameter Mnemonic
PV1 Src	PV1 source	00001:LP1 PV
Prog Num Src	Program number source	Note 2
Run Src	Run source	Note 2
Hold Src	Hold Source	Note 2
Reset Src	Reset Source	Note 2
Run/Hold Src	Run/Hold Source	Note 2
Run/Reset S	Run/Reset Source	Note 2
Advanc Prg Src	Advance Program source	Note 2
Advanc Seg Src	Advance segment source	Note 2
FineHbck1 Src	Fine holdback value source for PSP1	Note 2
CorseHbck1 Src	Course holdback value source for PSP1	Note 2
Hbck1 Dis Src	Holdback 1 disable source for PSP1	Note 2
WaitA Src	Wait A source	Note 2
WaitB Src	Wait B source	Note 2
WaitC Src	Wait C source	Note 2
PSP1 Reset Src	PSP1 reset source	00001:LP1 PV. Note 1

Note 1: The PSP Reset Source defines the programmer starting conditions. To servo to setpoint, wire the relevant reset source into the SP. To servo to PV, wire the relevant reset source into the PV.

The value which is wired into the Reset Source is the value which appears at the programmer output.

Note 2: By default these parameters are not soft wired.

The above table is repeated for PSP2 and PSP3. The default wiring is shown below:

PV2 Src	PV2 source	01025:LP2 PV
PSP2 Reset Src	PSP2 reset source	01025:LP2 PV. Note 1
PV3 Src	PV3 source	02049:LP3 PV
PSP3 Reset Src	PSP3 reset source	02049:LP3. Note 1

PSP1 (2 OR 3) Profile Run General Pages

This page is similar to the 'PROGRAM RUN' page for the synchronous programmer and provides information on the running program.

Table 17: These parameters provide running information of the PSP This page is available in operator and configuration level		PSP1 (2 or 3) PROFILE (Run General)		
Parameter Name	Parameter Description	Value	Default	Access Level
Program	Number of the running program	PSP1:01 to PSP1:20 Or name from user text	PSP1:01	L3
Prog DOs	Digital outputs summary (Up to 16) These are shown in this format if 'Named Dos' = 'No'	<input type="checkbox"/> <input type="checkbox"/> <input type="checkbox"/> ■ = Off □ = On		L3
Prog DO 1 (to 16)	If programmer event outputs have been configured, then, as an alternative to the previous presentation the event can be given a name. [PROGRAM EDIT (Options) – Named Dos? = Yes]	The name of the event is shown with its state On or Off	Off	L3
Time Remaining	Time remaining to end of program (up to 24 hrs)	Not Running or h:mm:ss		L3
Fast Run	Allows the program to fast run	No Yes	No	L3. Alterable in reset or complete
Delayed Start	Delay before the start of the program	h:mm:ss	0:00:00.0	L3
Program Status	Controls the program when not part of a group	Reset Run Hold Complete		L1
Prog Run	Programmer run status	1 = running		Conf
Prog Hold	Programmer hold status	1 = holding		Conf
Prog Reset	Programmer reset status	1 = reset		Conf
Prog End	Programmer end status	1 = end		Conf
New Seg	New segment loaded	1 = new segment for 100ms		Conf
Prog Time Elap	Program time elapsed (up to 24 Hrs)	h: mm: ss		L3 R/O
Prog Cycle Rem	Remaining number of cycles	1 to 999		L1 Alterable in Hold (only shown if 'Prog Cycles' > 0)
Total Segments	Number of segments in the running program	0 to 100		L1 Alterable in Hold
Segment Number	The currently running segment number	1 to 100		L1 Alterable in Hold
Segment Type	Running program segment type Profile = normal segment End Segment = End of prog Go Back = repeat part of prog	Profile End Segment Go Back	Profile	L1 R/O
Segment Name	A user defined name for the segment		Default Text	L1 R/O
Seg Time Rem	Time remaining in the current segment	d: h: m: s		L1 R/O Alterable if Time To Target prog and in Hold
Wait Status	Wait Status	No Wait Event A Event B Event C	No Wait	L1 R/O
Wait Condition	Wait condition for the running segment	No Wait Event A Event B Event C	No Wait	L1 Alterable in Hold
Prog User Val 1	Active Programmer User Val 1. Name is user configurable			L1

Table 17: These parameters provide running information of the PSP This page is available in operator and configuration level		PSP1 (2 or 3) PROFILE (Run General)		
Parameter Name	Parameter Description	Value	Default	Access Level
Prog User Val 2	Active Programmer User Val 2. Name is user configurable			L1
GoBack Rem	Number of repeat cycles remaining	1 to 999		L1 Alterable in Hold
End Action	The state required in the end segment	Dwell Reset		L1 R/O
Prog Reset DO	These are the digital events in Reset and are shown in this format if 'Named Dos' = 'No' The number of DO values is set by 'Num of Prog DOs' PROGRAM EDIT (Options) Not shown if Num of Prog Dos = 'None'	<input type="checkbox"/> <input type="checkbox"/> <input type="checkbox"/> <input type="checkbox"/> (up to 16) <input checked="" type="checkbox"/> = Off <input type="checkbox"/> = On		Only shown if configured. Alterable in Reset
Prog DO 1 (to 16)	If programmer event outputs have been configured, then, as an alternative to the previous presentation, the event can be given a name. [PROGRAM EDIT (Options) – Named Dos? = Yes]	The name of the event is shown with its state On or Off	Off	L1
Reset UsrVal1	Reset prog user 1 values. Name is user configurable			L1
Reset UsrVal1	Reset prog user 1 values. Name is user configurable			L1

PSP1 (2 OR 3) Profile Run Segment Pages

Table 18: These parameters show the running conditions in each segment of the running program		PSP1 (2 or 3) PROFILE (Run Segment Page)		
Parameter Name	Parameter Description	Value	Default	Access Level
Seg Time Rem	Segment time remaining	h: m: s		L1
PSP1 Type	PSP1 type Name is user configurable	Step Dwell Ramp		L1
PSP1	Working setpoint for profiled setpoint 1. Name is user configurable	Display range Note 1		L1. Alterable in Hold
PSP1 Target	Running segment target for profiled setpoint 1. Name is user configurable	Display range Note 1		L1. Alterable in Hold
PSP1 Dwell Time	Remaining dwell time for PSP1	h: m: s		L1. Alterable in Hold
PSP1 Rate	PSP1 ramp rate			L1
PSP1 HBk Appl	PSP1 holdback applied	No Yes		L1

Note 1: Range limited by user defined upper and lower limits. If HHHHH or LLLLL appear this indicates out of range high or low respectively.

PSP1 (2 OR 3) Profile Program Edit Parameters

This page is similar to the PROGRAM EDIT (Program Page) in the synchronous programmer

Table 19: These parameters set up the overall program.		PSP1 (2 or 3) PROFILE (Program Edit)		
Parameter Name	Parameter Description	Value	Default	Access Level
Program Number	Selects the program number to be edited. If 'Profile Lock' ≠ 'Unlocked', only those programs which were created prior to setting the 'Profile Lock' parameter can be selected.	PSP1:01 to PSP20:20 Or name from user text	PSP1:01	L1
Edit Function	Allows a program to be copied and pasted. The example in section Example: To Copy a Program describes how this feature is used	None Copy Program Paste Program	None	L1
Hbk Mode	Holdback mode None = no holdback Per prog = applied over the whole program Per seg = active in every segment	None Per Program Per Segment	None	L1

Table 19: These parameters set up the overall program.			PSP1 (2 or 3) PROFILE (Program Edit)	
Parameter Name	Parameter Description	Value	Default	Access Level
PSP1 HBk Type	Holdback type for PSP1 (per program) These are deviations between SP and PV Fine and course holdback allows two levels of holdback to be applied to different segments.	Off Fine Lo Fine Hi Fine Band Course Lo Course Hi Course Band	Off	L1 Only displayed if Per Program configured
PSP1 FineHBk	Fine holdback value for PSP1	Display Range	0	L1. Only shown if HBk Type ≠ Off
PSP1 CourseHBk	Course holdback value for PSP1	Display Range	0	
Rate Units	Rate units Only if program Type = Ramp Rate (PROGRAM GROUPS Options Page)	Per Second Per Minute Per Hour		L1
Hot Start	Allows hot start to be applied. Only appears if Hot Start = Yes (PROFILE SP1 Options Page)	Disabled Enabled	None	L1
Program Cycles	The number of times a program repeats.	Cont. to 999	Cont	L1
End Action	Defines the action in the end segment. Dwell - the program will dwell indefinitely at the conditions set in the end segment. Reset - the program will reset to the start conditions.	Dwell Reset		L1
Program Name	Allows a user defined name to be given to the program number	User string Each character can be set in turn		L1

PSP1 (2 or 3) Profile Segment Parameters







This page is similar to the PROGRAM EDIT (Segment Page) in the synchronous programmer.

Table 20: These parameters allow you to set up each segment in the program			PSP1 (2 or 3) PROFILE (Segment Edit)	
Parameter Name	Parameter Description	Value	Default	Access Level
Program	Selects the program number to be edited	PSP1:01 to PSP1:20 Or name from user text	PSP1:01	L1
Segment Number	Selects the segment number to be edited	1 to 100		L1
Edit Function	Allows a segment to be inserted The example in section Example: To Insert a Segment Into a Program describes how this feature is used	None Insert Segment Delete Segment	None	L1
Segment Type	Segment type	Profile End Segment Go Back	Profile	L1
Profile = a normal segment End Segment = the last segment in the program (press \odot to confirm) Go Back = repeat part of program. Not shown for segment 1.				
PSP1 Type	Profile setpoint 1 type	Step Dwell Ramp		L1
Only shown if Program Type = Ramp Rate and program not in End				
PSP1 Target	Profile setpoint 1 target value	SP1 lo limit to SP1 hi limit	0	L1
PSP1 Dwell Tm	Profile setpoint 1 dwell time	d : h : m : s	0:00:00.0	L1
Only shown if Program Type = Ramp Rate; Segment Type = Dwell and program not in End				
PSP1 Rate	Profile setpoint 1 rate			L1
Only shown if Program Type = Ramp Rate; Segment Type = Dwell and program not in End				

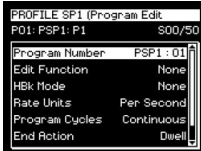
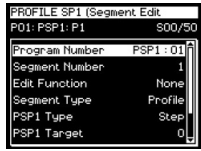

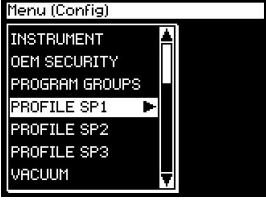



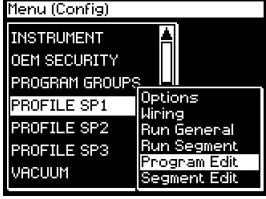



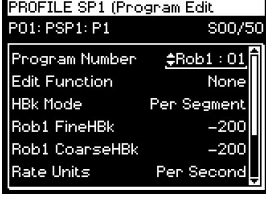



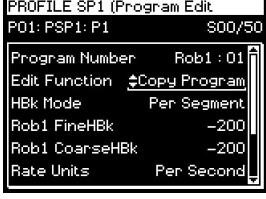



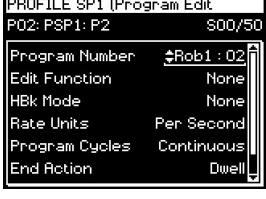





Table 20: These parameters allow you to set up each segment in the program			PSP1 (2 or 3) PROFILE (Segment Edit)	
Parameter Name	Parameter Description	Value	Default	Access Level
PSP1 Hbk Type	Profile setpoint 1 holdback type Only shown if holdback is configured per segment	Off Fine Lo Fine Hi Fine Band Course Lo Course Hi Course Band	Off	L1
Seg Duration	Segment duration for Time to Target programmer only	d : h : m : s	0:00:00.0	L1
Wait Event	Wait if selected event is true Only shown if wait events configured	No wait Event A Event B Event C	No Wait	L1
Prog User Val 1	Allows a Programmer User Val to be chosen. See also section Program User Values Only shown if Prog User Val 1 is configured	0 to 100	0	L1
Prog User Val 2	Allows a Programmer User Val to be chosen. See also section Program User Values Only shown if Prog User Val 2 is configured	0 to 100	0	L1
Prog DO Values	Digital outputs summary These are shown in this format if 'Named Dos' = 'No' The number of DO values is set by 'Num of Prog DOs' PROFILE SP1 (Options) Not shown if Num of Prog Dos = 'None'	<input type="checkbox"/> <input type="checkbox"/> <input type="checkbox"/> <input type="checkbox"/> (Up to 16) ■ = Off □ = On		L1
Seg Edit 1 (to 16)	If programmer event outputs have been configured, then, as an alternative to the previous presentation the event can be given a name. [PROGRAM EDIT (Options) – Named Dos? = Yes]	The name of the event is shown with its state On or Off	Off	L1
GoBack to Seg	Allows repeat segments to be set up within a profile. Go back defines the point in the program where the repeat segments are entered.	1 to no. of segments See also Section Go Back To Segment		L1
Go Back Cycles	Sets up the number of times the segments are repeated	1 to 999	1	L1
The above two parameters are only shown if segment type is Go Back				
Segment Name	Allows a user defined name to be chosen	Default Text to 50:Usr 50	Default Text	L1

Example: To Set Up and Run Program Groups













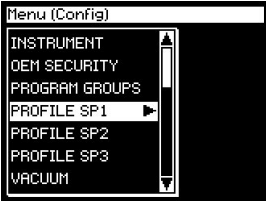

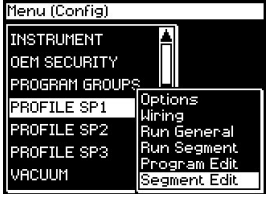

Using the two examples from section Program Groups and the general navigation procedures:

Do This	This Is The Display You Should See	Additional Notes
1. Set up a temperature program in PSP1:01		<p>See section PSP1 (2 OR 3) Profile Program Edit Parameters for the full list of parameters</p> <p>Set each parameter to suit your application</p>
2. Set up each segment in the program		<p>See section PSP1 (2 or 3) Profile Segment Parameters for the full list of parameters</p> <p>Set each parameter to suit your application</p>
3. Set up a pressure and Humidity program in PSP2:01 and PSP3:01		<p>These are the same as Example 1 shown in section Program Groups</p>
4. Set up further programs as required in PSP1:02 (to 20), PSP2:02 (to 20), and PSP3:02 (to 20)		<p>These are the same as Example 2 shown in section Program Groups</p>
5. When all PSPs have been set up, place them in Groups		
6. Repeat for futher groups		<p>In this example a delayed start of 3 hours has been placed on Group 2 which will run two profiles PSP1:P1 and PSP2:P6</p>
<p>7. To run the program press PROG </p> <p>This is also described in sections 8.30 and 8.31.</p>		<p>Select the group to run.</p> <p>Press PROG  again to run the selected group</p>

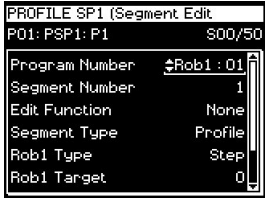
Example: To Copy a Program

Do This	This Is The Display You Should See	Additional Notes
1. From any display press  to access the page header menu. 2. Press  or  to select 'PROFILE SP1'		
3. Press  to select sub-headers 4. Press  or  to select 'Program Edit'		
5. Press  to select parameters and again to edit 'Program Number' 6. Press  or  to select the program number to be copied		In this case the program has been given a name by the user
7. Press  to scroll to 'Edit Function' 8. Press  or  to 'Copy Program'		When the program is copied the display returns to 'None'
9. Press  and  to scroll back to 'Program Number' 10. Press  or  to select the program to paste to – in this case program 2		
11. Press  again to scroll to 'Edit Function' 12. Press  or  to 'Paste Program'		Press  or  to confirm or cancel. If no button is pressed for 10 seconds the display reverts to previous and the paste is cancelled.

Example: To Insert a Segment Into a Program

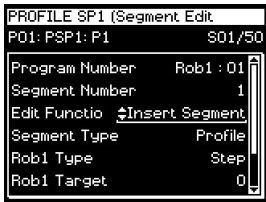
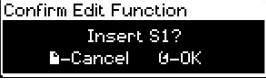
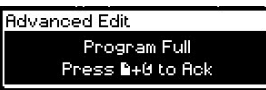
Do This	This Is The Display You Should See	Additional Notes
1. From any display press  to access the page header menu. 2. Press  or  to select 'PROFILE SP1'		
3. Press  to select sub-headers 4. Press  or  to select 'Segment Edit'		
5. Press  to select parameters and press again to edit 'Program Number' 6. Press  or  to select the program number to be edited		In this case the program has been given a name by the user
7. Press  or  to scroll to 'Edit Function' 8. Press  or  to 'Insert Segment' 9. Press  to confirm or  to cancel	 	In this case segment 1 is inserted and the total segment count increases by one If no button is pressed for 10 seconds the display reverts to previous.
		If all segments in the program are already configured the message 'Program Full' is shown

Programmer Error Messages

If an invalid entry is made when setting up programs through the front panel, a pop up error message will appear. For example a pop up will occur if an attempt is made to copy and paste a program which has more segments than the controller has left. The messages are similar to those which are shown if the same action is implemented over digital communications – see section Digital Communications Diagnostics.

Running an Asynchronous Programmer

As with the synchronous programmer the group of programs can be run using:







1. The 'PROG' button.
2. A digital input configured to activate all configured PSPs.
3. Digital inputs configured to run each PSP separately.
4. Via a command from digital communications.

If the PROG button is used (as described in the following section), a pop-up window is shown which allows you to choose the format of the program. The other methods listed above are designed for remote or fixed operation in which case the pop-up window is not displayed.

The program may also be controlled using the relevant parameters in the lists. These are:

5. 'Group Status' in the PROGRAM GROUPS Active Group list. This allows all configured PSPs to be started together.
6. 'Program Status' in the PSP1 (2 or 3) PROFILE Run General list. This allows each PSP to be run separately.

Example: To Run a Program Using The Prog Button

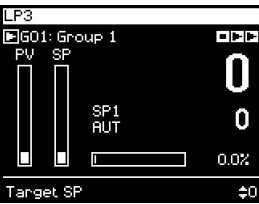
Do This	This Is The Display You Should See	Additional Notes
<p>1. From any display Press </p>		<p>The Run Group Status pop-up will be shown. The following conditions may be selected:</p> <p>Group to run Group 1 to Group 20 or USER SELECT (Press Δ or ∇ to choose)</p>
<p>2. Press  again to Run the program</p>		<p>Group 1 to 20 selects pre-set profiles as set up in PROGRAM GROUPS Active Group page. If the user changes the profiles in this pop-up display the changes become permanent.</p> <p>(Press \circlearrowleft to scroll down the list)</p> <p>USER SELECT will choose the last selected Program Group but if the profiles are changed they are only applicable to the current run</p>
<p>3. Press  again to Hold the program</p> <p>4. Press  and hold for 3 seconds to Reset the program</p>		<p>Profile SP1 Not Used or 01:PSP1:P1 to 20:PSP1:20</p> <p>Not Used means that the profile will not be run in this program 01:PSP1:P1 will select PSP1 Program 1 to PSP1 Program 20</p>
<p>This is an example of an Overview display</p> <p>Note the symbols shown on each of these displays as described in the following section</p>		<p>Profile SP2 Not Used or 01:PSP2:P1 to 20:PSP2:20</p> <p>Profile SP3 Not Used or 01:PSP3:P1 to 20:PSP3:20</p> <p>Delayed Start This can be set between 0:00:00 and 500:00:0 hrs. This value counts down when Run is selected. In the event of a power fail, delayed start retains its value prior to the power fail, but the request to run is cancelled.</p>

A running program may be interrogated and changes made to segments in the same way as a synchronous programmer.

The programmer mimic can also be displayed in the same way as a synchronous programmer.

Asynchronous Programmer Status Bar

The programmer status bar is shown in the top right hand corner of the loop overview displays (as selected by the LOOP button).

They are shown as

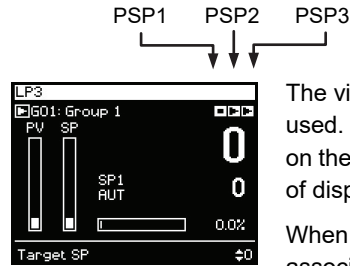

The view shown here is applicable when Groups are used. The number of displayed status symbols depends on the number of programmer blocks used, but the order of display is always left to right – with no gaps.

When Groups are not used the program status is associated with the individual loop pages.

Symbols Used

Reset Run Hold

The current status is shown in inverse, e.g. PSP is in Hold

These symbols are also used on other views, for example, the Run Group Status pop-up shown in the previous section.

Digital Programmer

What is the Digital Programmer?

The digital programmer provides a timed control of a single digital output. It may be used during any segment of a Setpoint Programmer or it may be used independently of the Setpoint Programmer.

A sequence of eight Off and On times may be set for the output and up to four Digital Programs can be set. Figure 40 shows an example of a timed digital output program.

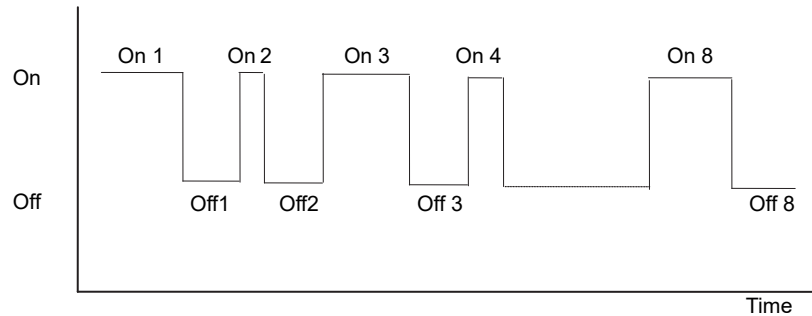





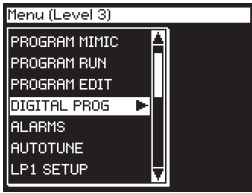







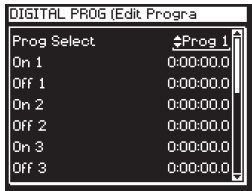



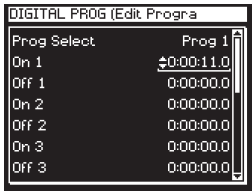





Figure 40 An Example of a Programmed Digital Output

Step	Time	Description
On 1	1:00:00.0	On starting the sequence the output will be ON for 1 hour
Off 1	0:30:00.0	The output switches OFF for 30 minutes
On 2	0:05:00.0	The output switches ON for 5 minutes
Off 2	0:30:00.0	The output switches OFF for 30 minutes
On 3	1:00:00.0	The output switches ON for 1 hour
Off 3	0:25:00.0	The output switches OFF for 25 minutes
On 4	0:10:00.0	The output switches ON for 10 minutes
Off 4	0:00:00.0	
On 5	0:00:00.0	
Off 5	0:00:00.0	The step is omitted for any time set to zero
On 6	0:00:00.0	
Off 7	0:00:00.0	
On 8	1:10:00.0	The output switches ON for 1 hour 10 minutes
Off 8	0:40:00.0	The output switches OFF for 40 minutes and is then reset to the start of the sequence

The sequence may be run by:

- Setting the 'Prog Status' parameter to 'Run'
- Wiring the 'Run/Hold Src' to:
 - A digital input controlled an external source such as a push-button
 - A programmer 'User Value'

To Edit The Digital Programmer

Do This	This Is The Display You Should See	Additional Notes
1. From any display press  to access the page header menu. 2. Press  or  to select 'DIGITAL PROG'		
3. Press  to show sub-headers 4. Press  or  to select 'Edit Program'		
5. Press  to show the list of parameters 6. Press  again to select 'Prog Select' 7. Press  or  to change the program number if required		Up to four programs can be chosen
8. Press  to select 'On 1' 9. Press  or  to increase or decrease the on time for the first output in the sequence 10. Repeat for the eight On and Off periods which make up the sequence		Tip 😊 To enter a large time period press  and  together. This will underline the mins and hours sections independently each time the  button is pressed. The hours/mins can then be raised or lowered using  or 

The full list of parameters is shown in the following table ↓↓

Digital Program Edit Page

Table 21: These parameters edit the digital programmer			DIGITAL PROG (Edit Program Page)	
Parameter Name	Parameter Description	Value	Default	Access Level
Prog Hi Limit	Program select upper limit	0 to 3		L3
Prog Select	Program select	Prog 1 to Prog 4		L3
Prog Enum	User string for first custom enumeration	Not enumerated Usr01 to Usr 50	Not enumerated	L3
On 1	On period 1	0:00:00.0	0:00:00.0	L3
Off 1	Off period 1	to 99:59:59.9	0:00:00.0	L3
On and Off periods are repeated up to period 8		If this setting is exceeded HHHH is displayed. To reduce the value Press and hold  button	0:00:00.0	L3

Digital Program 1 to 4 Page

Table 22:	These parameters are associated with Digital Programs 1 to 4		DIGITAL PROG (Dig Prog x Page)	
Parameter Name	Parameter Description	Value	Default	Access Level
Reset Src	Reset wire source	Modbus address	None	Conf
Run/Hold Src	Run/Hold (equivalent to Prog Status) wire source	Modbus address	None	Conf
OP Enable Src	Output wire source	Modbus address	None	Conf
Reset Disable	When Reset Disable = Off the program is in reset	Off On	Off	L3
Prog Status	Program status	Hold Run		L3
OP Enable	Enables the output	Off On	Off	L3
Reset on Pfail	Power fail recovery see section Power Fail Recovery	Off On	Off	L3
Program Cycles	Number of cycles for the sequence	Continuous to 999	Continuous	L3
Seg Time Rem	Segment time remaining	0:00:00.0 to 99:59:59.9		L3
Output	Shows the current state of the output	Off On		L3
Output (Inv)	Shows the current inverted state of the output	Off On		L3
Prg End	Program complete Off = prog running On = prog complete	Off On		L3 R/O

Power Fail Recovery

In the event of a power fail to the controller, the parameter, 'Reset on Pfail', defines how the controller behaves on restoration of the power.

If this parameter = 'On' then 'Prog Status' = 'Hold' and 'Reset Disable' = 'Off' at power up.

If Prog Status and Reset Disable have been soft wired they override this state.

Cascade Trim Mode – Earlier Controllers

This section applies only to controllers built before April 2001 with software versions 3 or less. Controllers built after this date have software version 4.0 or greater and use the cascade trim block diagram shown in the previous sections.

Earlier versions used the block diagram shown below.

These later versions use additional trim limits and scaling to provide improved control in this mode and it may be advantageous to upgraded to Version 4.0 or greater.

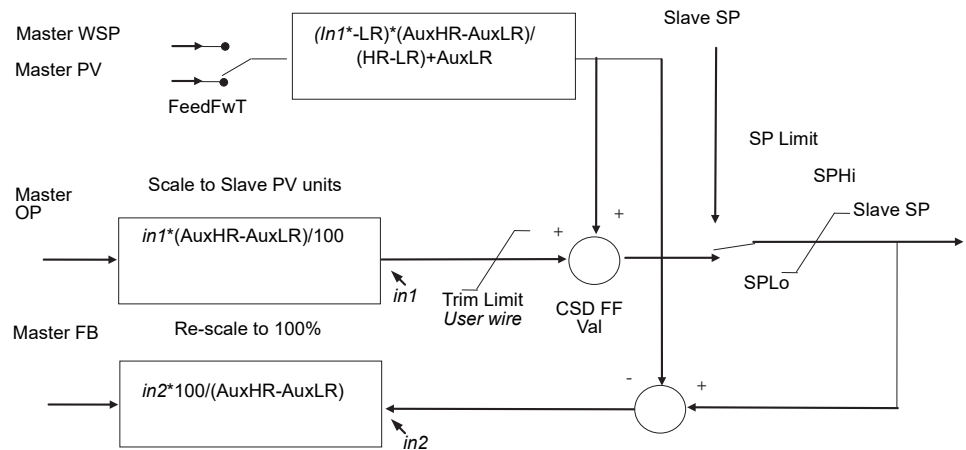

Figure 41 Cascade Trim Mode - Software Versions Earlier Than V4.0

Cascade Parameters (prior to April 2001)

Table 23: These parameters edit the digital programmer		DIGITAL PROG (Edit Program Page)		
Parameter Name	Parameter Description	Value	Default	Access Level
Disable CSD	Cascade disable status. (It is sometimes useful to disable cascade when starting a process. This also returns the controller to single loop control using the local SP.)	Off On		L1
CSD FF Value	Cascade feedforward value i.e. The value being fed forward	Range of signal being fed forward		L3
Range of signal being fed forward	Cascade feedforward trim limit i.e. The amount the master output can be trimmed up and down	Range of slave loop		L3
Work FF Value	Working feedforward value			R/O
The above three parameters only appear if 'FF Type' ≠ 'None'				
Master OP	Cascade master PID output power	Range of slave loop		R/O

Alarm Operation

Definition of Alarms and Events

Alarms are used to alert an operator when a pre-set level or condition has been exceeded. They are normally used to switch an output - usually a relay - to provide interlocking of the machine or plant or external audio or visual indication of the condition.

Soft Alarms are indication only within the controller and are not attached to an output (relay).

Events - can also be alarms - but are generally defined as conditions which occur as part of the normal operation of the plant. They do not generally require operator intervention. An example might be to open/close a vent during a programmer cycle. The controller does not display the alarm status on the front panel.

For the purposes of the configuration of this controller, alarms and events can be considered the same.

Customisable Parameter Names

Throughout this chapter parameter names shown in *italics* are customisable by the user. The name of the parameter may vary, therefore, from instrument to instrument.

Typical customisable parameter names are:

- Alarm names
- Loop names
- Module and Input names
- Custom units
- Promoted parameters

Types of Alarm Used in 2704 Controller

This section describes graphically the operation of different types of alarm used in the 2704 controller. The graphs show measured value plotted against time. The measured value may be any analogue value available in the controller.

Full Scale High

The Process Variable (PV) exceeds a set high level.

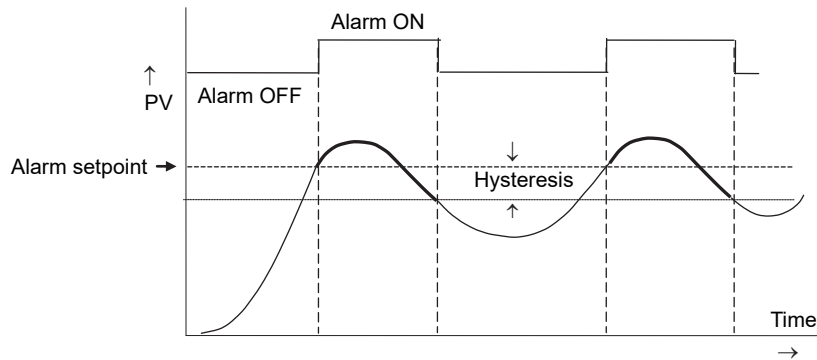

Hysteresis is the difference between the alarm ON value and the alarm OFF value. It is used to prevent relay chatter.

Full Scale Low

The Process Variable (PV) exceeds a set low level.

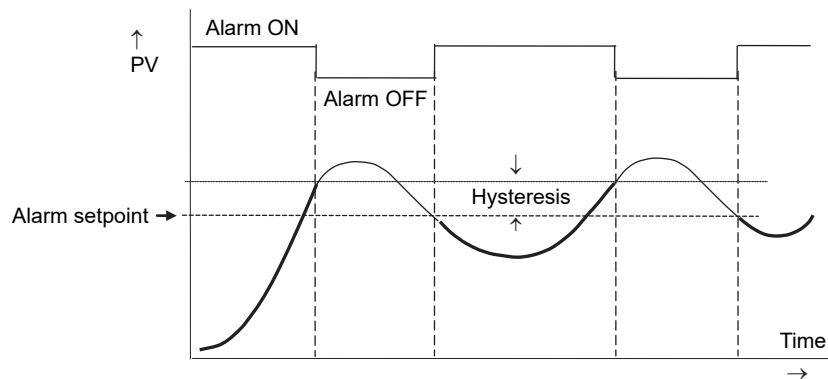

Deviation High Alarm

The alarm occurs when the difference between the process variable and the setpoint is positive by greater than the alarm setpoint.

Note: For User Alarms the deviation is the difference between the two user wired analogue inputs.

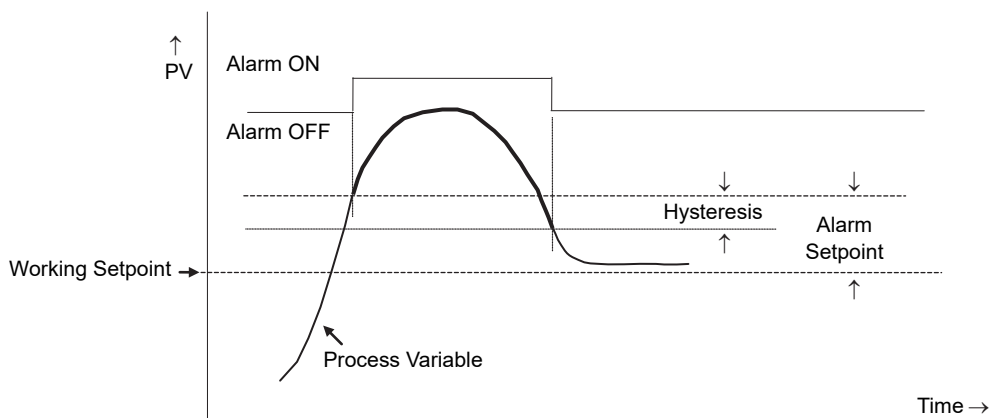

Deviation Low Alarm

The alarm occurs when the difference between the process variable and the setpoint is negative by greater than the alarm setpoint.

Note: For User Alarms the deviation is the difference between the two user wired analogue inputs.

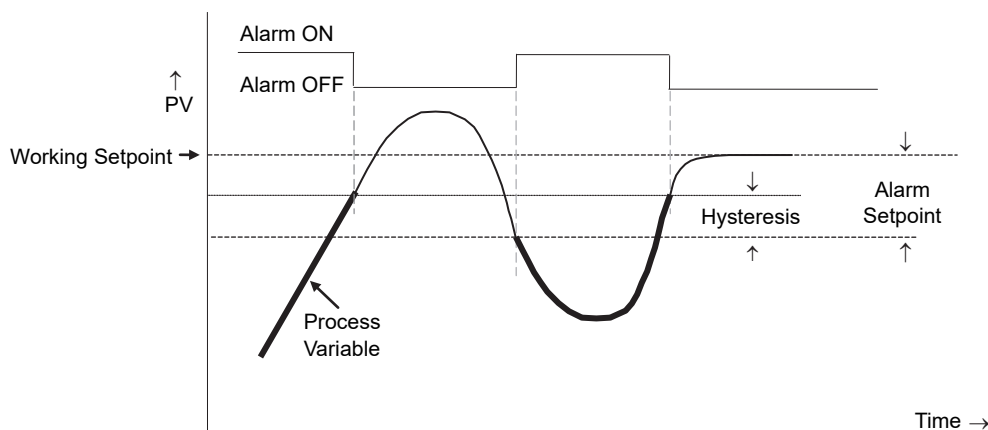

Deviation Band

A deviation band alarm monitors the process variable and the working setpoint and continuously compares the difference against the alarm setpoint. If the difference is either negative by greater than the alarm setpoint, or positive by greater than the alarm setpoint, the alarm state will be active.

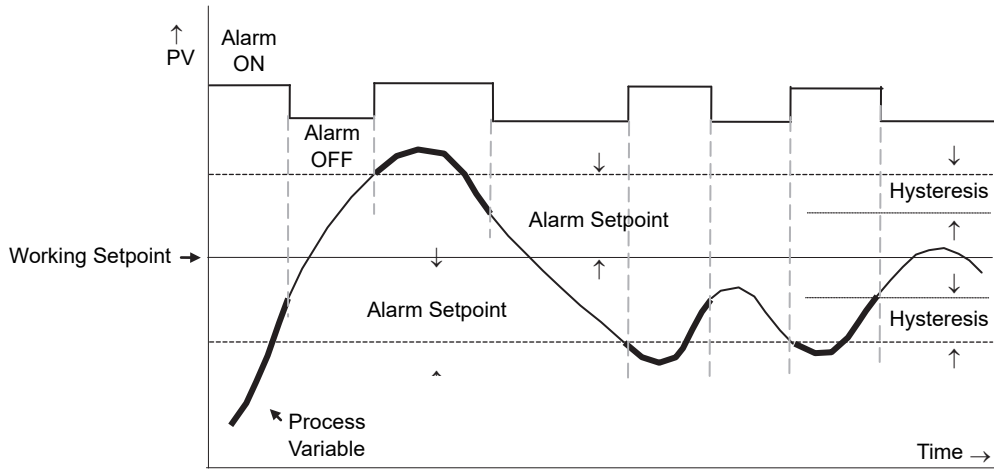

Rate Of Change Alarm (Negative Direction)

The Process Value falls faster than the alarm setting.

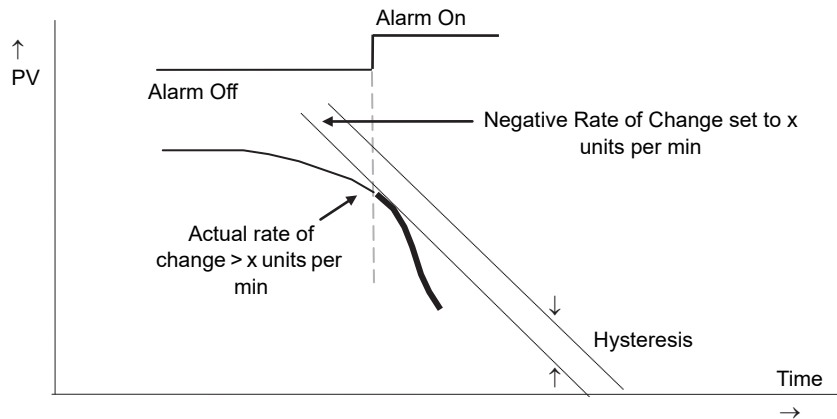

Rate Of Change Alarm (Positive Direction)

The Process Value rises faster than the alarm setting.

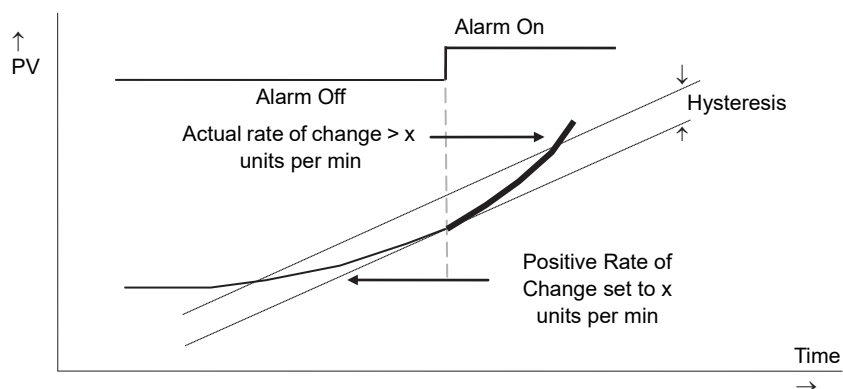

Note:

1. Separate alarms are required for positive and negative rates of change.
2. An alarm is indicated during the period that the actual rate of change is greater than the set rate of change.
3. There may be a small delay before the instrument displays an alarm condition since the instrument requires several samples. This delay increases if the set value and actual value are close together.
4. A hysteresis value of, say, 1 unit per second will prevent the alarm from 'chattering' if the rate of change varies by this amount.

Blocking Alarms

A Blocking Alarm only occurs **after** it has been through a start up phase. It is typically used to prevent alarms from being indicated until the process has settled to its normal working conditions.

Full Scale Low With Blocking

The alarm only occurs **after** the start up phase when low alarm has first entered a safe state. The next time a low alarm occurs will cause the alarm to become active.

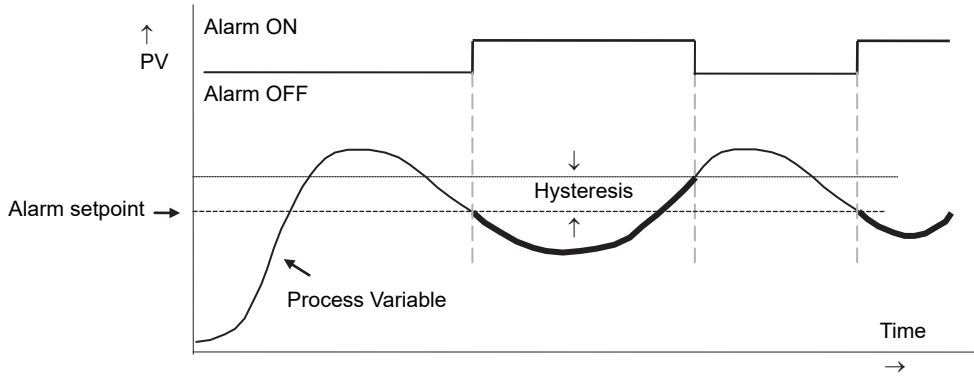

Full Scale High Alarm With Blocking

The alarm only occurs **after** the start up phase when high alarm has first entered a safe state. The next time a high alarm occurs will cause the alarm to become active.

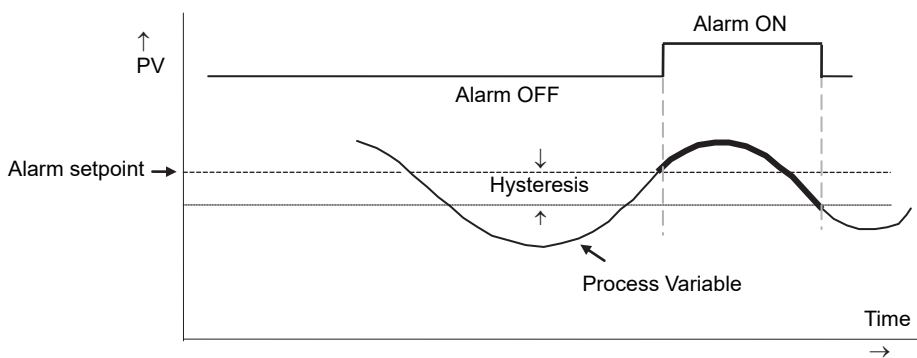

i.e. If the controller is powered up with PV > 'Hi Alarm SP' no alarm is indicated. The PV must reduce below the 'High Alarm SP' and increase again to > 'Hi Alarm SP'. The alarm condition will then be indicated.

If the controller is powered up with PV < 'Hi Alarm SP' an alarm is indicated as soon as PV > 'Hi Alarm SP'

Deviation Band With Blocking

The alarm only occurs **after** the start up phase when low deviation alarm has first entered a safe state. The next time an alarm occurs, whether high band or low band will cause the alarm to become active.

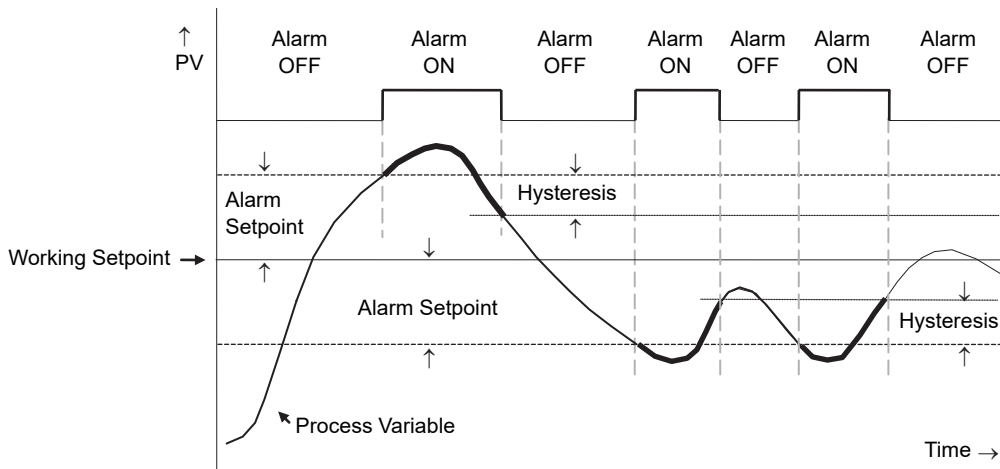

Latching Alarms

The alarm is indicated until it is acknowledged by the user. Acknowledgement of an alarm can be through the controller front buttons, from an external source using a digital input to the controller or through digital communications.

There are two ways that the alarm can be acknowledged:

1. **Automatic.** The alarm continues to be active until both the alarm condition is removed AND the alarm is acknowledged. The acknowledgement can occur **BEFORE** the alarm condition is removed.
2. **Manual.** The alarm continues to be active until both the alarm condition is removed AND the alarm is acknowledged. The acknowledgement can only occur **AFTER** the alarm condition is removed.

These are shown below for a Full Scale High Alarm.

Latched Alarm (Full Scale High) - Automatic

The alarm is displayed until it is acknowledged.

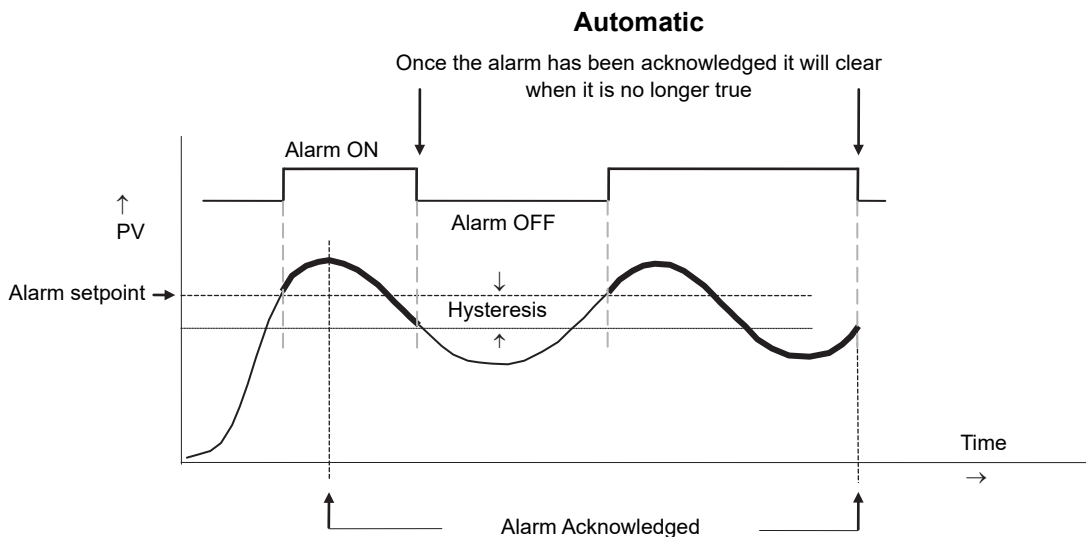

Latched Alarm (Full Scale High) - Manual

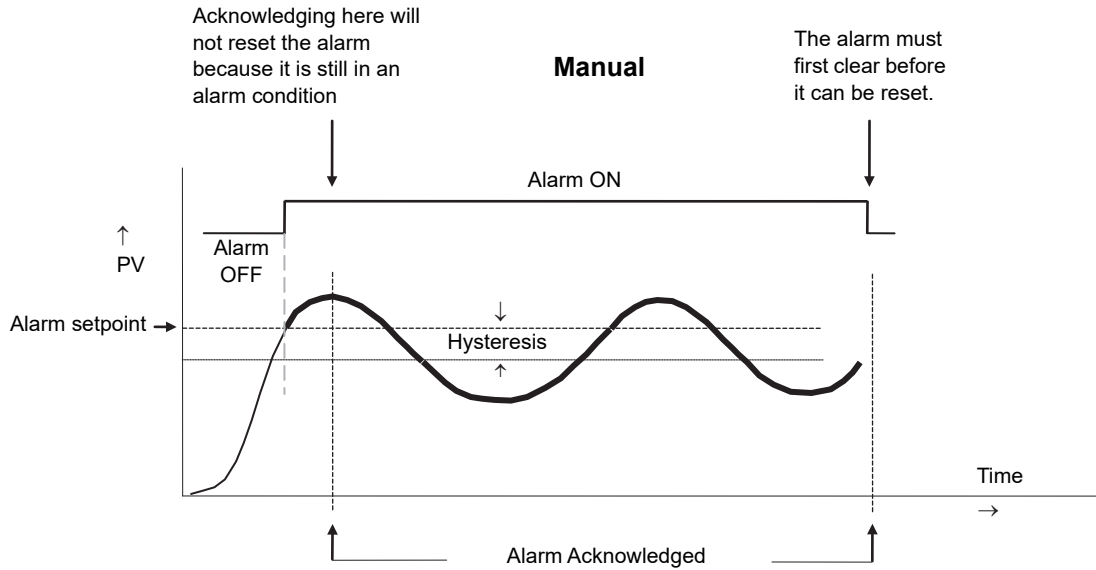

Grouped Alarms

Alarms can be associated with different aspects of the process. They are grouped in accordance with the functions they perform as follows:

- | | |
|-----------------------|--|
| Loop Alarms | Alarms associated with each control loop. Examples are: High, Low, Deviation and Rate of Change. Two alarms are available for each loop. On a new controller these are the only alarms which are configured - those listed below must be enabled in configuration level. |
| PV Input Alarms | Alarms which operate on the PV input. Examples are: High and Low. Two alarms are available with this input. |
| Analogue Input Alarms | Alarms which operate on the analogue input. Examples are: High and Low. Two alarms are available with this input. |
| Module Alarms | Alarms which operate on each plug in module. These can be input or output alarms depending upon the function of the module fitted. These alarms are associated with modules 1, 3, 4, 5, & 6, since module 2 is reserved for future use. |
| User Alarms | Eight undedicated alarms which can be wired to any variable. |

How Alarms Are Indicated

Alarms are indicated when the controller is in normal operating level. When an alarm occurs a message will appear on the display which will indicate the source and the type of alarm. The format of this alarm message is:

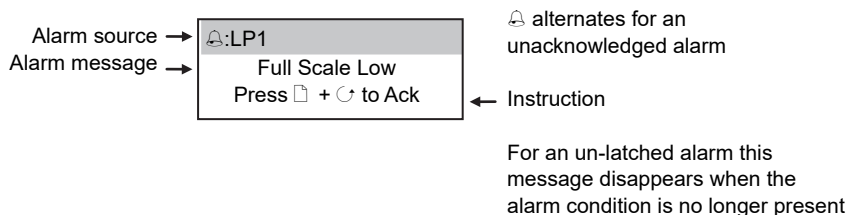

When the alarm has been acknowledged the message shown in the banner of the pop up window above will now be shown in the Loop Display page.

The 🔔 symbol will be shown steady in the top banner of any page if any alarm is still present.

If a relay has been connected to the output of the alarm, it will operate to allow an external beacon or audible device to be activated. In general, the relay will be de-activated when the alarm is acknowledged, subject to the latching configuration.

Alarm Delay Time

A delay time can be set for each alarm between the occurrence of the alarm and the indication of the alarm in the controller. This is useful to prevent spurious alarms from being indicated in some noisy or rapidly changing processes.

















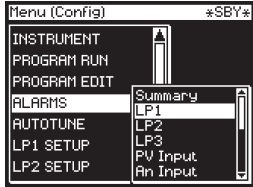

Delay time can only be set in Configuration level.

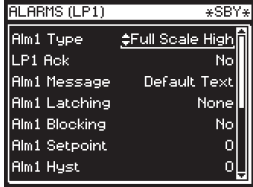

If delay time has been configured for the alarm the user may be aware that the occurrence of an alarm may not necessarily correspond with the display of the alarm

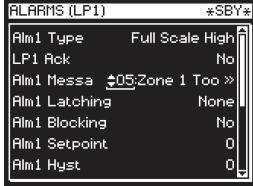

To Configure an Alarm

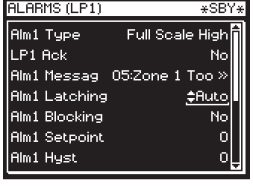
The example below is shows how to configure a Loop 1 Alarm. Each loop has two alarms, shown on the display as Alm1 and Alm2.

The procedure described below is the same for all alarms.

Do This	This Is The Display You Should See	Additional Notes
<ol style="list-style-type: none"> From any display press  as many times as necessary to access the page header menu Press  or  to select 'ALARMS' 		
<ol style="list-style-type: none"> Press  to display sub-headers Press  or  to select 'LP1' 		<p>The first sub-header is Summary.</p> <p>Further sub-headers allow other alarms to be configured</p> <p>Text shown in <i>italics</i> is user definable and will appear if:-</p> <ol style="list-style-type: none"> User Text is enabled in INSTRUMENT page, see section Instrument User Text Page The text has been assigned to this parameter
<ol style="list-style-type: none"> Press  to display LP1 alarm parameters Press  again to edit 'Alm1 Type' Press  or  to configure the alarm type 	<p style="text-align: center;">To Configure Alarm Type</p> 	<p>The choices are:-</p> <ul style="list-style-type: none"> Off Full Scale Low Full Scale High Deviation Band Deviation High Deviation Low Rate of Change
<ol style="list-style-type: none"> Press  to scroll to 'Alm1 Message' Press  or  to select the message 	<p style="text-align: center;">To Configure Alarm Message</p> 	<p>The message which appears when an alarm occurs can be customised from the list of User Text messages.</p> <p>This example chooses User Text number '05' previously set to 'Zone 1 Too Hot'. See also section Instrument User Text Page</p>
<ol style="list-style-type: none"> Press  to scroll to 'Alm1 Latching' Press  or  to choose the latching type 	<p style="text-align: center;">To Configure Alarm Latching</p> 	<p>The choices are:-</p> <ul style="list-style-type: none"> None Auto Manual Event See also 8.1 <p>See section Segment Types for a description of alarm latching</p>

Do This	This Is The Display You Should See	Additional Notes
To Configure Alarm Blocking, Alarm Setpoint, Alarm Hysteresis, Alarm Delay, Alarm Inhibit		
<ol style="list-style-type: none"> 1. Press  to scroll to the parameter 2. Press  or  to choose the condition or value 		

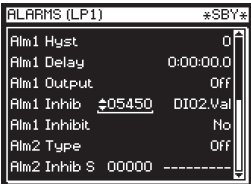
To Configure Alarm Inhibit Source		
<ol style="list-style-type: none"> 1. Press  to display 'Alm1 Inhibit Sr' 2. Press  or  to select the Modbus address of the source parameter which you wish to wire to. 		<p>The alarm can be inhibited while an event is true.</p> <p>Here it is shown soft wired to Digital Input 02.</p> <p>For a list of commonly used wireable parameters see Appendix D.</p> <p>The next parameter is Alm1 Inhibit. If this is set to:-</p> <p>No → the event is ignored</p> <p>Yes → the alarm waits for the event to become true.</p>

Alarm Tables

The following alarm pages are available:-

Summary	A summary of all alarms. This table is also available in Level 3 but can be promoted to Level 1, see section Instrument Page Promote Page	} Alarms for These pages are configured As in section To Configure an Alarm.
Alarms Loop 1	See section To Configure an Alarm	
Alarms Loop 2	These are the same as loop 1	
Alarms Loop 3	These are the same as loop 1	
PV Input	High and Low Alarms are available for the fixed PV Input.	
Analogue Input	High and Low Alarms are available for the fixed Analogue Input.	
Module 1, 3, 4, 5 & 6	High and Low Alarms are available each module.	
User 1 to 8	These are alarms which are user defined	

Alarms (Summary Page)

Table 24: These parameters indicate alarm status		ALARMS (Summary Page)		
Alarm parameters in this table only appear if the function is enabled. The last three parameters always appear.				
Parameter Name	Parameter Description	Value	Default	Access Level
<i>LP1 Ack1</i>	Loop 1 alarm 1 acknowledge	No Yes		L1
<i>LP1 Ack2</i>	Loop 1 alarm 2 acknowledge	No Yes		L1
<i>LP2 Ack1</i>	Loop 2 alarm 1 acknowledge	No Yes		L1
<i>LP2 Ack2</i>	Loop 2 alarm 2 acknowledge	No Yes		L1
<i>LP3 Ack1</i>	Loop 3 alarm 1 acknowledge	No Yes		L1
<i>LP3 Ack2</i>	Loop 3 alarm 2 acknowledge	No Yes		L1
<i>PV Alm AckH</i>	PV Input high alarm acknowledge	No Yes		L1
<i>PV Alm AckL</i>	PV Input low alarm acknowledge	No Yes		L1
<i>An Alm AckH</i>	Analogue Input high alarm acknowledge	No Yes		L1
<i>An Alm AckL</i>	Analogue Input low alarm acknowledge	No Yes		L1
<i>Module 1A 1 AckH</i>	Module 1 high alarm acknowledge	No Yes		L1
<i>Module 1A 1 AckL</i>	Module 1 low alarm acknowledge	No Yes		L1
The above two alarms are repeated for Module 3, 4, 5 and 6 if the modules are fitted				
<i>User 1 Ack</i>	User defined alarm 1 acknowledge	No Yes		L1
The above alarm is repeated for up to eight user alarms if they have been configured				
<i>New Alarm</i>	Set to true on a new alarm	No Yes		R/O
<i>Ack All Alms?</i>	Acknowledges all alarms (Global acknowledge)	No Yes		L3
<i>Ack All Src</i>	Global Acknowledge Source	Modbus Address		Conf

Alarms LP1 (2 or 3) Page Parameters

Table 25: These parameters configure the Loop alarms. Alarm 1 parameters only appear if the 'Alm 1 Type' ≠ 'None' Alarm 2 parameters only appear if the 'Alm 2 Type' ≠ 'None's		ALARMS LP1 (2 or 3)		
Parameter Name	Parameter Description	Value	Default	Access Level
Alm1 Type	Alarm 1 Type	Off Full Scale Low Full Scale High Deviation Band Deviation High Deviation Low Rate of Change	As order code	Conf
LP1 Ack	Group alarm acknowledge for loop 1. Acknowledges both loop alarms.	No Yes	No	L1
Alm1 Message	Alarm 1 message. Use △ or ▽ to choose from the User Text messages set up in section Instrument User Text Page	Default Text or User defined Text 01 to 50	Default Text	Conf
Alm1 Latching	Alarm 1 latching. Use △ or ▽ to choose latching type	None Auto Manual Event	None	Conf
Alm1 Blocking	Alarm 1 blocking. Use △ or ▽ to enable/disable	No Yes	No	Conf
Alm1 Setpoint	Alarm 1 Setpoint	Controller range	0.0	L1
Alm1 Hyst	Alarm 1 hysteresis	Controller range		L3
Alm1 Delay	Alarm 1 delay	0:00:00.0	0.0	Conf
Alm1 Output	Alarm 1 output	Off On	Off	R/O
Alm1 Inhibit Src	Alarm 1 inhibit source	Modbus address	None	Conf
Alm1 Inhibit	Alarm 1 inhibit	No Yes	No	L3
Alm2 parameters are the same as Alm1 parameters if 'Alm2 Type' ≠ 'None'				

Alarms (PV Input Page) Parameters

Table 26: These parameters set up the alarms associated with the PV input signal. They are only displayed if enabled using the parameter FS Hi Alarm or FS Lo Alarm		ALARMS (PV Input)		
Parameter Name	Parameter Description	Value	Default	Access Level
FS Hi Alarm	Full scale high alarm enable/disable	Disabled Enabled	Disabled	Conf
PV Alm Ack	Group acknowledge. Acknowledges both Hi and Lo alarms	No Acknowledge	Default Text	L1
FS Hi Message	Full scale high message. Use \triangle or ∇ to choose from the User Text messages set up in section Instrument User Text Page	Default Text or User defined Text 01 to 50		Conf
FS Hi Blocking	Full scale high blocking. Use \triangle or ∇ to enable/disable	No Yes		Conf
FS Hi Latching	Full scale high latching. Use \triangle or ∇ to choose latching type	None Auto Manual Event		Conf
FS Hi Setpoint	Full Scale High Alarm (1) Setpoint	Controller range		L1
FS Hi Hyst	Full Scale High alarm (1) hysteresis	Controller range		L3
FS Hi Delay	Full Scale High alarm (1) delay	0:00:00.0		Conf
FS Hi Output	Full Scale High alarm (1) output	Off On	Off	R/O
FS Lo Alarm	Full scale Low alarm enable/disable	Disabled Enabled	Disabled	Conf
FS Lo parameters are the same as FS Hi parameters if 'FS Lo Alarm' = 'Enabled'				
Inhibit Src	Alarm inhibit source	Modbus Address		Conf
Inhibit	Alarm inhibit value	No Yes	No	L3

Alarms (An Input Page) Parameters

The parameters for the Analogue Input Alarms are identical to the PV Input Alarms.

Alarms (Module 1,3, 4, 5 & 6 Page) Parameters

The parameters for the Module Alarms are identical to the PV Input Alarms. Module alarm pages only appear if suitable modules are fitted.

Alarms (User 1 to 8 Page) Parameters

Table 27: These parameters set up user defined alarms.			ALARMS (User 1) (to User 8)	
Parameter Name	Parameter Description	Value	Default	Access Level
Type	Alarm Type	Off Full Scale Low Full Scale High Deviation Band Deviation High Deviation Low Rate of Change	As order code	Conf
User 1 Ack	Group alarm acknowledge for user alarm 1	No Acknowledge	No	L1
Src A	Alarm source A	Modbus address	None	Conf
Src B	Alarm source B	Modbus address	None	Conf
Name	User defined alarm name. Use \triangle or ∇ to choose from the User Text messages set up in section Instrument User Text Page	Default Text or User defined Text 01 to 50	Default Text	Conf
Message	User defined message. Use \triangle or ∇ to choose from the User Text messages set up in section Instrument User Text Page	Default Text or User defined Text 01 to 50	Default Text	Conf
Latching	Indicates if the alarm has been configured as latching	None Auto Manual Event		R/O at L3
Blocking	Indicates if the alarm has been configured as blocking	No Yes		R/O at L3
Setpoint	Alarm Setpoint	Controller range		L1
Hyst	Alarm hysteresis	Controller range		L3
Delay	Alarm delay	0:00:00.0		Conf
Output	Alarm output	Off On	Off	R/O at L1
Val A	Used if the user alarm is deviation. Normally internally wired to the PV	Display min to display max		R/O at L3 if wired to PV source
Val B	Used if the user alarm is deviation. Normally internally wired to the SP	Display min to display max		R/O at L3 if wired to SP source
Inhibit Src	Alarm inhibit source	Modbus address		Conf
Inhibit	Alarm inhibit	No Yes	No	L3

The above table is repeated for:

User alarm 2
User alarm 3
User alarm 4

User alarm 5
User alarm 6
User alarm 7
User alarm 8

Alarm Wiring Examples

Control Loop With High and Low Alarms

In this example two alarms are added to the loop wiring example shown in Section An Example of Soft Wiring. Alarm 1 is configured as a high alarm and operates the fixed relay 'AA'. This relay is inhibited until a digital input, 'DIO1' becomes true. Alarm 2 is configured as a low alarm and operates a relay module in slot 3.

----- = Connections made in example shown in Section An Example of Soft Wiring.

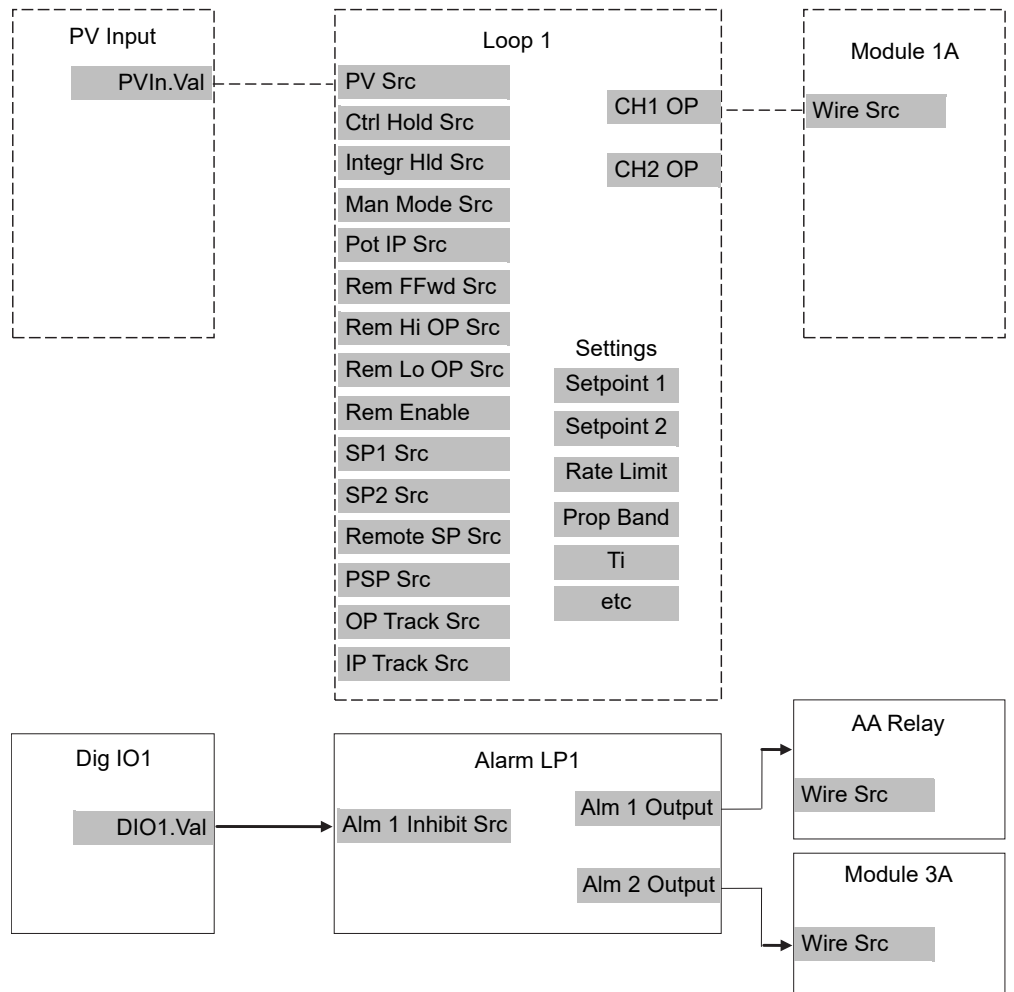

Figure 42 Loop Alarm Wiring

Implementation

1. In ALARMS/LP1 Page (section Alarms LP1 (2 or 3) Page Parameters) set 'Alm1 Type' = Full Scale High
2. In ALARMS/LP1 Page (section Alarms LP1 (2 or 3) Page Parameters) set 'Alm2 Type' = Full Scale Low
(Note: other parameters such as alarm message, alarm latching, alarm blocking are also set in this page)
3. In ALARMS/LP1 Page (section Alarms LP1 (2 or 3) Page Parameters) Set 'Alm1 Inhibit Src' = 05402:DO1.Val
This connects the alarm 1 inhibit to fixed digital input 1
4. In STANDARD IO/AA Relay Page (section Standard IO AA Relay Parameters) Set 'Wire Src' = 11592:L1Alm1.OP
This connects Alarm 1 output to operate the AA relay
5. In MODULE IO/Module 3A Page (section Relay Output) Set 'Wire Src' = 11602:L1Alm2.OP
This connects Alarm 2 output to operate the relay fitted in module position 3.

See Appendix D for list of Modbus addresses.

☺ See 'Copy and Paste' description in Soft Wiring.

Loop Alarm Inhibited if Programmer not in Run

In this example the alarm is gated as in the previous example. To determine if the programmer is in Run mode an Analogue Operator (An Oper 1) may be used.

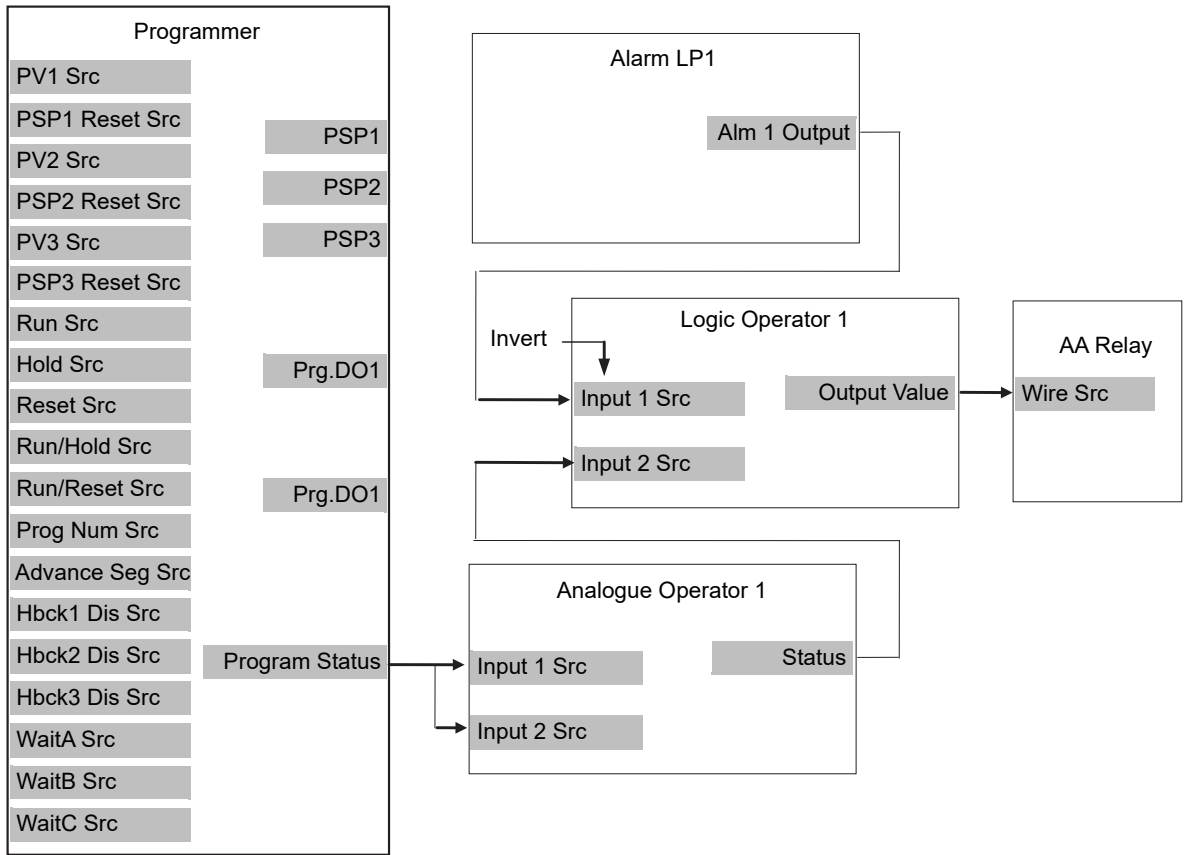

Figure 43 Loop Alarm Inhibited if Programmer not in Run

Implementation

1. In MODULE IO/Module 3A Page
(section Relay Output)
 - set 'Operation' = AND
 - set 'Invert' = Invert Input 1
 - Invert input 1 is necessary because the previous operation results in 0 for a true state
 - Set 'Input 1 Src' = 06239:-----
 - This is the Status of the Logic Operator
 - Set 'Input 2 Src' = 11592: L1Alm1.OP
 - This sets the logic operator such that both inputs must be true before the output status is true

2. In ANALOGUE OPERS/Analogue 1 Page (section Analogue Operator Parameters)
 - set 'Operation' = Select Max
 - set 'Input 1 Src' = 05844:-----
 - This is the Programmer Status
 - set 'Input 2 Src' = 05844
 - It is necessary to connect both inputs of an analogue operator
 - set 'Input 1 Scalar' = 1
 - set 'Input 1 Scalar' = 2
 - set 'Low Limit' = +1
 - set 'High Limit' = +1
 - (Note: when Programmer Status = Run the result of the calculation is 0)

3. In STANDARD IO/AA Relay Page (section Standard IO AA Relay Parameters)
 - Set 'Wire Src' = 07176:LgOp1.OP
 - This connects Logic Operator 1 output to operate the AA relay

Loop Set Up

In the controller LOOP SET UP appears after AUTOTUNE in the operator display. In this manual, however, an explanation of how to set up each loop is given before the tuning procedure. Also the order in which each sub-header appears in this chapter is not necessarily the same as the order in which they appear in the controller because single loop control is explained before dual loops.

What is Loop Set Up

The 2704 controller can have up to three control loops. Each loop operates independently and can be configured for On/Off, PID or Valve Positioning control. Additionally, each loop can have an auxiliary loop associated with it, and this allows other control strategies to be implemented such as cascade, ratio and override control. The LOOP SETUP pages allow you to configure the type of control most suited to your process. The pages are divided into a number of sub-headers - briefly described below:

LP1 (2 or 3) SETUP ▶	SP Page	Allows you to configure the setpoint parameters for a particular loop
<i>Note:</i> Text shown in italics is user definable in configuration mode and may be different from that shown	(SP(Aux)Page	Allows you to configure the setpoint parameters for an auxiliary loop
	Cascade Page	These parameters only appear if the control loop is configured for cascade control.
	Ratio Page	These parameters only appear if the control loop is configured for ratio control.
	Override Page	These parameters only appear if the control loop is configured for override control.
	PID Page	These parameters allow you to set up the three term or PID values for the selected loop. See also Controller Applications
	PID (Aux) Page	These parameters allow you to set up the three term or PID values for the selected auxiliary loop. See also Tuning
	Motor Page	Allows you to set up the values for a valve positioning output when the selected loop is configured for motorised valve control. See also Controller Applications
	Output Page	Allows you to set up the values for the output when the selected loop is configured for analogue or digital control outputs.
	Diagnostic Page	These parameters are for diagnostic purposes on the selected loop.
	(Diag Aux) Page	These parameters are for diagnostic purposes on the selected auxiliary loop.

Loop Set Up (Options Page)

Table 28:	This page determines the control action (*) See notes for further parameter descriptions		<i>LP1 SETUP</i> Options Page	
Parameter Name	Parameter Description	Value	Default	Access Level
Loop Type	To configure loop type	Single Cascade Override Ratio	As order code	Conf
Control Type ⁽¹⁾	Control Type	See note 1	As order code	Conf
Control Action ⁽²⁾	Control action	Reverse Direct	Reverse	Conf
Aux Ctl Action ⁽²⁾	Control action of the auxiliary loop	Reverse Direct	Reverse	Conf
Cool Type ⁽³⁾	Cooling action	Linear Oil Water Fan		Conf
Prog Setpoint ⁽⁴⁾	Loop 1 PSP select	PSP1 PSP2 PSP3 None		Conf
Deriv Type ⁽⁵⁾	Derivative type	PV Error		Conf
FF Type ⁽⁶⁾	Feedforward type	None Remote FeedFwd SP Feedforward PV Feedforward		Conf
Force Man Mode ⁽⁷⁾	Forced manual output mode.	Off Track Step		Conf
Rate Lim Units ⁽⁸⁾	Rate limit units	Per Second Per Minute Per Hour	Per minute	Conf
Bumpless PD	Initialises the manual reset on Auto/Manual transfer	Yes No	Yes	Conf
Ti/Td Units	Integral and Derivative time units	sec min	sec	Conf
OnOff SBk Type	Sensor break action. Only appears if On Off control is configured	-100 0 100		Conf
Prop Bnd Units	Proportional band units	Eng Units and %		R/O
Enable Pwr Fbk	Power feedback enable	Off On		Conf
Rem SP Config	Remote setpoint configuration	SP Only LSP Trim RSP Trim	SP Only	Conf
SBrk Type	Sensor break type	Output Hold		Conf
Manual Track ⁽⁹⁾	Manual track	Off Track		Conf
Remote Track ⁽¹⁰⁾	Remote tracking	Off Track		Conf
Program Track ⁽¹¹⁾	Programmer track	Off Track		Conf
Start SRL Mode ⁽¹²⁾	Defines Setpoint Rate Limit action on power up.	None No Change Hold Clear Hold	None	Conf
Start Rem Mode ⁽¹³⁾	Defines Local/Remote action on power up.	No Change Local Remote	No Change	Conf

Table 28:	This page determines the control action (*) See notes for further parameter descriptions		LP1 SETUP Options Page	
Parameter Name	Parameter Description	Value	Default	Access Level
Startup Mode ⁽¹⁴⁾	Manual mode on power up	Continue SBrk Output	Continue	Conf
Start WSP Mode ⁽¹⁵⁾	Defines the Working SP action on power up.	None PV Target SP		Conf
Ramp from WSP ⁽¹⁶⁾	To allow servo from the current working setpoint or current PV	No Yes	No = servo from PV	Conf

Notes

4. Control Types

- PID-Ch1 Only Channel 1 PID only. Use for single channel control only
- OnOff-Ch1 Only Channel 1 On/Off. Use for On/Off control.
- VP-Ch1 Only Channel 1 Motorised valve position output - boundless mode.
- VPB-Ch1 Only Channel 1 Motorised valve position output - bounded mode.
- PID-Ch1 PID-Ch2 Both output channels PID. Use for heat/cool type applications
- PID-Ch1 OnOff-Ch2 Channel 1 PID control, channel 2 On/Off. Use for single channel PID control plus On/Off Control
- OnOff-Ch1&2 Both output channels On/Off. Use for On/Off control

5. Control Action

- Direct** The output will increase positively if the PV > SP.
- Reverse** The output will increase positively if PV < SP.

6. Cool Type

- Linear** The control output follows linearly the PID output signal, i.e. 0% PID demand = 0 power output, 50% PID demand = 50% power output, 100% PID demand = 100% power output.
- Oil, Water, Fan** The control output is characterised to compensate for the non-linear effect of the cooling medium - oil, water and blown air. Typically used in extrusion processes.

7. Prog Setpoint

When the programmer is running, this parameter determines from which setpoint profile the loop obtains its setpoint. If None is selected this parameter can be soft wired.

8. Deriv Type

- Derivative on PV defines that derivative action responds to changes to PV only
- Derivative on Error defines that derivative action responds to changes to differences between SP and PV.

9. FF Type

Feedforward control is used typically to overcome time delays or to compensate for the effect of external influences such as control signals from other loops in the process. This is added directly to the output of the PID algorithm, before output limiting and dual output conversions are performed. Trim Limit applied to the PID calculated output is possible when Feedforward is enabled.

10. Force Manual Mode

Force Manual Mode allows you to select how the loop behaves on auto/ manual transfer.

Off	Transfer between auto/manual/auto takes place bumplessly
Track	Transfer from auto to manual, the output reverts to the previous manual value. Transfer from manual to auto takes place bumplessly
Step	Transfer from auto to manual, the output goes to a pre-set value. This value is set by the parameter 'Forced OP' in LPx SETUP/Output Page, section Output Parameters. Transfer from manual to auto takes place bumplessly

11. Rate Limit Units

Rate limit can be applied to the SP, such that the change in PV takes place at a controlled rate. It is used where a full programmer is not justified and is typically used to protect the process from sudden changes in the PV.

12. Manual Track

When the controller is switched into Manual mode the working setpoint tracks the value of the PV so that on return to Auto mode is bumpless.

13. Remote Track

When the controller is switched into Remote SP mode the local setpoint tracks the value of the remote SP so that the return to Local SP is bumpless.

14. Program Track

When the controller is running a program the local setpoint tracks the value of the program setpoint. If the controller is switched to Local SP the transfer takes place bumplessly.

15. Start SRL Mode

Defines Setpoint Rate Limit action on power up.

None	No Change. Setpoint Rate Limit starts up in the same mode as power off
Hold	Setpoint Rate Limit is in hold mode on power up
Clear Hold	Setpoint Rate Limit is active on power up

16. Start Rem Mode

Defines Local/Remote action on power up.

No Change	The controller powers up in the same mode as power off
Local	The controller starts up in Local setpoint mode
Remote	The controller starts up in Remote setpoint mode

17. Manual Mode on Power up

This parameter provides the choice between 'Continue' and 'SBrk Output' as the start up control mode. Selecting Continue ensures that on power up the loop control action will remain at its last state. Selecting 'SBrk Output' forces the relevant loop into the manual mode with 'SBrk OP' (Loopx → SETUP → Output) applied to the output.

18. Start WSP Mode

Defines the Working SP action on power up.

- | | |
|------------------|---|
| None | No Change. The controller powers up in the same mode as power off |
| PV | The controller servos to PV on power up |
| Target SP | The controller servos to the target setpoint on power up |

19. Ramp from WSP

Parameter added from software version 6 onwards.

Single Loop Control

Single loop control is configured when 'Loop Type' (Options Page) = 'Single'. A block diagram of a simple single loop, single output controller is shown below:

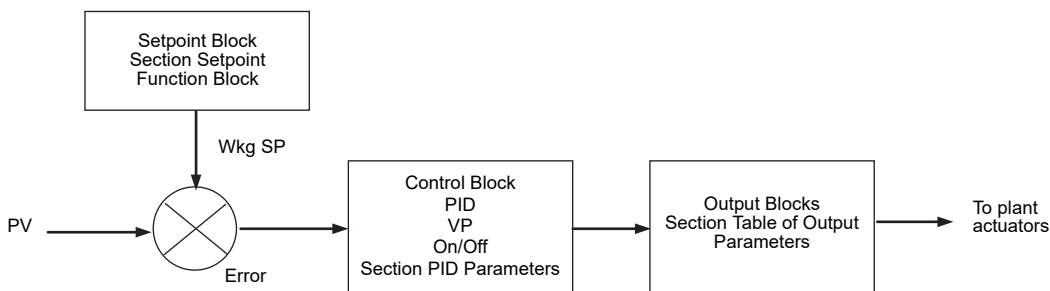

Figure 44 Single Loop Controller

Loop Set Up (Wiring Page) Single Loop

Table 29: These parameters allow you to soft wire between function blocks.			LP1 SETUP Wiring Page	
Parameter Name	Parameter Description	Value	Default	Access Level
PV Src	Process variable source	Modbus address	05108: PVIn.Val	Conf
Manual OP Sr	Target OP power source	Modbus address		Conf
OPRtLim En S	OP rate limit enable source	Modbus address		Conf
OPRtLim Src	OP rate limit source	Modbus address		Conf
Ctrl Hold Src	Freeze control flag source	Modbus address		Conf
Integr Hld Src	Integral hold flag source	Modbus address		Conf
Man Mode Src	Auto/manual select source	Modbus address		Conf
Pot IP Src	Pot position source	Modbus address		Conf
Rem FFwd Src	Remote feedforward source	Modbus address		Conf
Rem Hi OP Src	Remote high power limit source	Modbus address		Conf
Rem Lo OP Src	Remote low power limit src	Modbus address		Conf
The above two parameters do not appear if Control Type (section Loop Set Up (Options Page)) = On/Off				
Rem SP Ena Src	Remote setpoint enable source	Modbus address		Conf
Remote SP Src	Remote setpoint source	Modbus address		R/O
SP Select Src	Internal setpoint select src	Modbus address		Conf
SP1 Src	Setpoint 1 source	Modbus address		Conf
SP2 Src	Setpoint 2 source	Modbus address		Conf
Rt Lim Dis Src	SP rate limit disable src	Modbus address		Conf
Rt Lim Src	SP rate limit src	Modbus address		Conf
Rt Lim Hld Src	SP rate limit hold source	Modbus address		Conf
Prog SP Src	LP1 PSP wire source	Modbus address		Conf
PID Set Src	PID Set Source	Modbus address		Conf
RemSchedIP	Remote scheduling input source	Modbus address		Conf
Power FF Src	Power feedforward source	Modbus address		Conf
Track Enab S ⁽¹⁾	OP track enable source	Modbus address		Conf
Track Src	Track output source	Modbus address		Conf
Ext FBack Src	External feedback source	Modbus address		Conf
Prop Band S	Proportional band source	Modbus address		Conf
Integral Src	Integral term source	Modbus address		Conf
Derivative Src	Derivative term source	Modbus address		Conf
Aux Prop Sr	Auxiliary loop proportional band source	Modbus address		Conf
Aux Integral	Auxiliary loop integral term source	Modbus address		Conf
Aux Derivati	Auxiliary loop derivative term source	Modbus address		Conf

Setpoint Definition

The controller setpoint is the **Working Setpoint** which may be sourced from a number of alternatives. This is the value ultimately used to control the process variable in a loop.

LSP derives from a parameter called the local setpoint which is the value which the operator can alter. This local SP may be derived from one of two setpoints, **Setpoint 1** or **Setpoint 2**. Either of these setpoints may be selected by a parameter in the controller or soft wired to a digital input.

In remote mode, the working setpoint is modified by the **Remote SP + Local Trim**, when 'Enable Rem SP' is set to 'Yes'. When 'Remote Track' (LP1 SETUP/Options Page) is set to 'Track' the transition to the 'Active Local SP' (SP1 or SP2) takes place bumplessly and the Active Local SP tracks the value of the Remote SP.

In a controller/programmer the Working SP is derived from the output of the programmer function block. In this case the setpoint varies in accordance with fixed rates of change stored within a program.

Setpoint Function Block

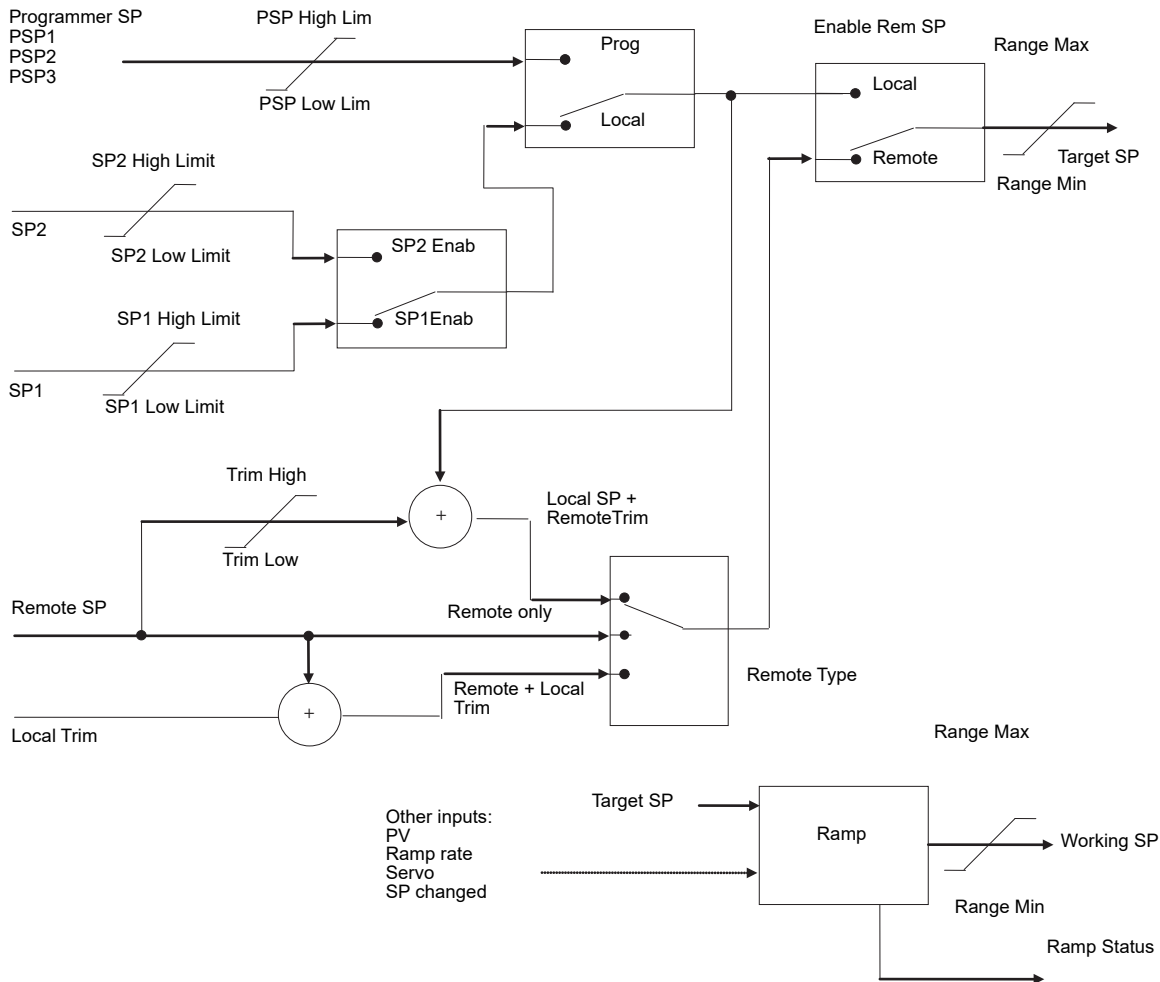

Figure 45 Setpoint Function Block

Setpoint Parameters

Table 30:		This list allows you to configure SP parameters Other parameters are available in operation levels		LP1 SETUP (SP Page)	
Parameter Name	Parameter Description	Value	Default	Access Level	
Range Min	PV low limit	Min to max	-200 *	Conf	
Range Max	PV high limit	disp. limit	1372 *	Conf	
SP Select	Internal setpoint select	Setpoint 1 Setpoint 2		L1	
SP1 Low Limit	Setpoint 1 low limit	Range units	-200 *	L3	
SP1 High Limit	Setpoint 1 high limit		1372 *	L3	
Setpoint 1	Setpoint 1 value			L1	
SP2 Low Limit	Setpoint 2 low limit		-200 *	L3	
SP2 High Limit	Setpoint 2 high limit		1372 *	L3	
Setpoint 2	Setpoint 2 value			L1	
Working SP	Current value of the setpoint			L3	
Disable Rt Lim	Setpoint Rate limit disable	No Yes		L3	
Rt Lim Hold	SP rate limit hold	No Yes	No	L3	
Rate Limit Val	Rate of change of setpoint	Off to range		L3	
Trim Lo Lim	Local setpoint trim low limit	Range units		L3	
Trim Hi Lim	Local setpoint trim high limit			L1	
Local SP Trim	Applies a trim value to the remote setpoint	No Yes		L1	
Enable Rem SP	Remote setpoint enable			L1	
Remote SP	Remote setpoint value	Range units		L1	
HBk Type	SP rate limit holdback type	Off Low High Band		L3	
HBk Value	SP rate limit holdback value	Display range		R/O	
HBk Status	SP rate limit holdback status	Off Holdback		L3	

* If temp units = °C

LP1 Setup (SP Aux) Page

Table 31:		This list allows you to configure auxiliary loop setpoint limits. It only appears if cascade or override control is configured, see sections 11.10. and 11.12. Other parameters are available in operation levels.		LP1 SETUP (SP Aux) Page	
Parameter Name	Parameter Description	Value	Default	Access Level	
Range Min	Auxiliary PV low limit	Min to max display limit	-200 *	Conf	
Range Max	Auxiliary PV high limit		1372 *	Conf	
SP Low Limit	Auxiliary setpoint 1 low limit	Range units	-200 *	L3	
SP High Limit	Auxiliary setpoint 1 high limit		1372 *	L3	
OVR SP Trim	Override loop setpoint trim			L3. Only appears when Override control is configured	
Local SP	The setpoint which the controller reverts to when not in cascade, ratio or override			L1	
Working SP	The current value of the setpoint in use			L1	
* If temp units = °C					

This table does not appear if the Loop Type is Ratio or Single.

Pid Control

PID control, also referred to as 'Three Term Control', is a technique used to achieve stable straight line control at the required setpoint. The three terms are:

- P Proportional band
- I Integral time
- D Derivative time

The output from the controller is the sum of the contributions from these three terms. The combined output is a function of the magnitude and duration of the error signal, and the rate of change of the process value. It is possible to set P, PI, PD or PID control.

Proportional Term

The proportional term delivers an output which is proportional to the size of the error signal. An example of this is shown in Figure 46, for a temperature control loop, where the proportional band is 10°C and an error of 3°C will produce an output of 30%.

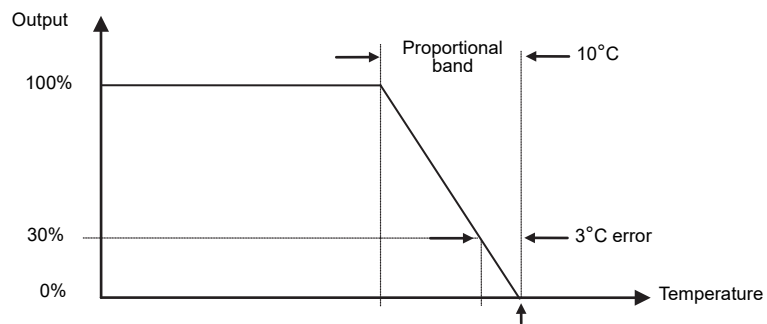

Figure 46 Proportional Action

Proportional only controllers will, in general, provide stable straight line control, but with an offset corresponding to the point at which the output power equals the heat loss from the system.

Integral Term

The integral term removes steady state control offset by ramping the output up or down in proportion to the amplitude and duration of the error signal. The ramp rate (reset rate) is the integral time constant, and must be longer than the time constant of the process to avoid oscillations.

Derivative Term

The derivative term is proportional to the rate of change of the temperature or process value. It is used to prevent overshoot and undershoot of the setpoint by introducing an anticipatory action. The derivative term has another beneficial effect. If the process value falls rapidly, due, for example, an oven door being opened during operation, and a wide proportional band is set the response of a PI controller can be quite slow. The derivative term modifies the proportional band according to this rate of change having the effect of narrowing the proportional band. Derivative action, therefore, improves the recovery time of a process automatically when the process value changes rapidly.

Derivative can be calculated on change of PV or change of Error. For applications such as furnace control, it is common practice to select Derivative on PV to prevent thermal shock caused by a sudden change of output following a change in setpoint.

High and Low Cutback

While the PID parameters are optimised for steady state control at or near the setpoint, high and low cutback parameters are used to reduce overshoot and undershoot for large step changes in the process. They respectively set the number of degrees above and below setpoint at which the controller will start to increase or cutback the output power.



Figure 47 High and Low Cutback

PID Block Diagram

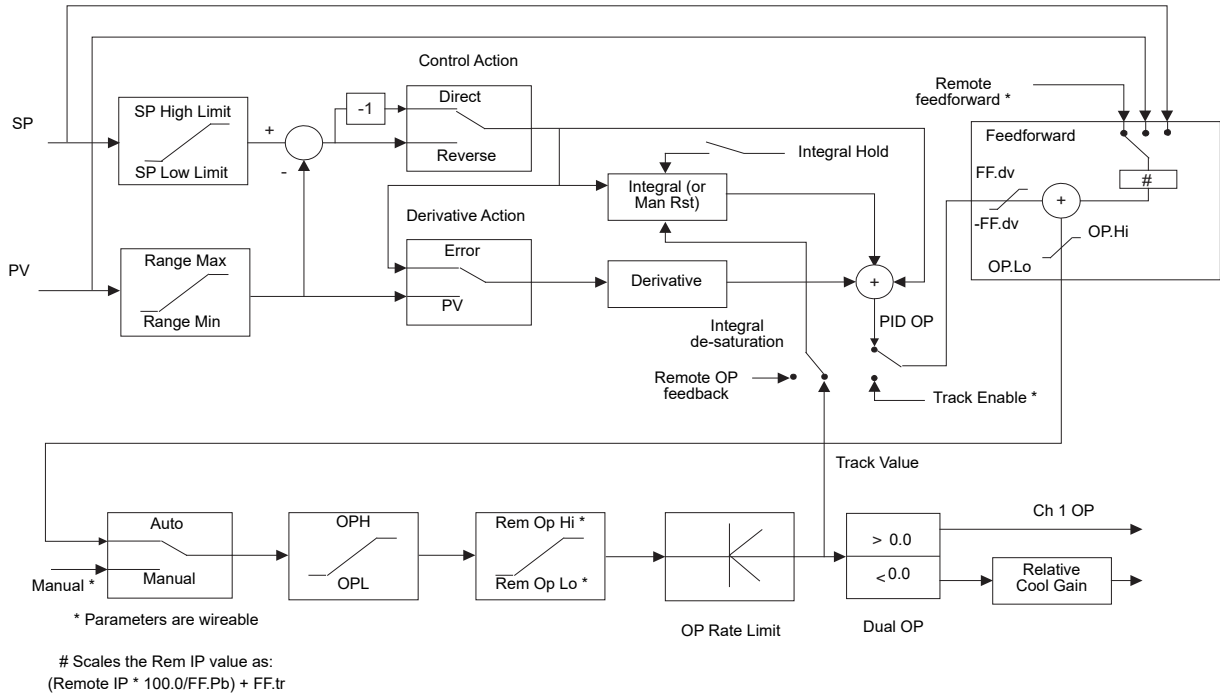

Figure 48 PID Block Diagram

Remote (External) OP Feedback

The Remote OP Feedback shown in the PID block diagram, allows an external source of output to stop integral wind up in some applications such as cascade control. The integral will calculate a PID output to match the external value when manual to auto bumpless transfer is activated.

If 'Ena OP Track' (LP1 SETUP/Output) = 'Yes', the output will be replaced by the 'OP Track Value'. The feedback signal is used for the integral de-saturation. When the 'Remote OP Feedback' is wired the feedback signal is forced to a remote output feedback. When not wired the default internal OP is used for the integral calculation.

Analogue Value

The Analogue Value is a customisable parameter available in the PID (and PID Aux) pages which provides the user with additional flexibility when designing a control strategy. This parameter is called **Analogue Value (An Value 1 to 3)**. It is available for each PID set if Gain Scheduling has been configured and for each loop configured. It can be 'soft wired' in configuration mode to perform a specific function relevant to the particular process being controlled. Examples include: Output Power Limit, SP Feedforward Trim, etc.

Gain Scheduling

Gain scheduling is the automatic transfer of control between one set of PID values and another. Gain scheduling may be used in very non-linear systems where the control process exhibits large changes in response time or sensitivity, see Figure 49 below. This may occur, for example, over a wide range of PV, or between heating or cooling where the rates of response may be significantly different. The number of sets depends on the non-linearity of the system. Each PID set is chosen to operate over a limited (approximately linear) range.

In the case of the 2704 controller, this is done at a pre-settable strategy defined by the parameter 'Schedule Type' found in the *Loop SETUP/PID* page in configuration level. The choices are:

- PV The transfer between one set and the next depends on the value of the PV
- SP The transfer between one set and the next depends on the value of the SP
- Error The transfer between one set and the next depends on the value of the error
- OP The transfer between one set and the next depends on the value of the OP demand
- Set The PID set can be selected manually
- Rem Sched IP The transfer between one set and the next depends on the value from a remote source for example, a digital input
- Soft Wired To a parameter chosen by the user.

The 2704 controller has six sets of PID values – the maximum number which you may wish to use is set up in *Loop SETUP/PID* 'Num of Sets' parameter. You can select the active set from:

1. A digital input
2. A parameter in the *Loop Setup(PID)* page
3. Or you can transfer automatically in gain scheduling mode.

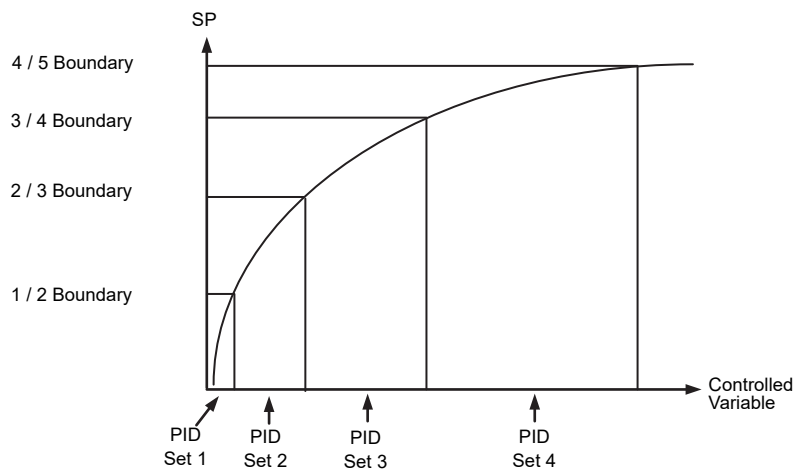



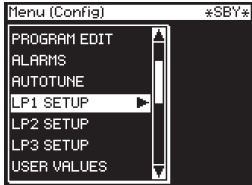



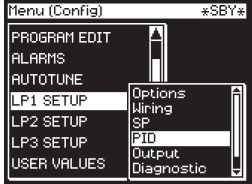



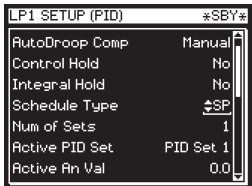

Figure 49 Gain Scheduling in a Non-Linear System

To Configure Gain Scheduling

Do This	This Is The Display You Should See	Additional Notes
<p>1. From any display press  as many times as necessary to access the page header menu</p> <p>2. Press  or  to select 'LP1 SETUP'</p>		<p>Alternatives are LP 2 and LP 3. These only appear in the list if configured</p>
<p>3. Press  to display sub-headers</p> <p>4. Press  or  to select 'PID'</p>		
<p>5. Press  to show the parameter list.</p> <p>6. Press  again to select 'Schedule Type'.</p> <p>7. Press  or  to select the gain scheduling type to use</p>		<p>The choices are shown in section Gain Scheduling</p> <p>Remaining parameters can be set in the same way</p>

Gain scheduling is uni-directional acting on the magnitude of the scheduling variables.

The PID, Cutback Low and High, Manual Reset, Cool Gain, Analogue Value, Output High and Low values must now be set up for each gain scheduling set.

Tuning the PID parameters when using gain scheduling is described further in Tuning.

PID Parameters

Table 32: These parameters allow you to configure PID sets		LP1 SETUP (PID Page)		
Parameter Name	Parameter Description	Value	Default	Access Level
FF Offset	Feedforward offset value			R/O L3
FF Prop Band	Feedforward proportional band			R/O L3
FF Trim Lim	Feedforward trim limit			R/O L3
Remote FFwd	Remote feedforward	±100		L3
The above five parameters are only shown if FF Type (LP1 SETUP/Options) = Remote, SP or PV FF				
Rem Sched IP	Remote input Only shown if Schedule Type (below) = Rem Sched IP	Display range		L3
Loop Brk Time	Loop break time	Off On		L3
AutoDroop Comp Note 1	Manual reset when Integral turned off	Manual Calc		L3
Control Hold	Control hold flag. Freezes the control output	No Yes		L3
Integral Hold	Integral hold flag	No Yes		L3

Table 32:		These parameters allow you to configure PID sets		LP1 SETUP (PID Page)	
Parameter Name	Parameter Description	Value	Default	Access Level	
Schedule Type	Scheduling type	Off Set SP PV Error OP Rem Sched IP Wired	Off	Conf	
Num of Sets	Number of PID sets to use	1 to 6	1	Conf	
Active PID Set	The PID set in current use	PID Set 1 to 6		R/O L1	
Active An Val	Displays the current analogue value being used			R/O L1	
1/2 Boundary	Sets the level at which PID set 1 changes to PID set 2	Range units		L3	
2/3 Boundary	Sets the level at which PID set 2 changes to PID set 3	Range units		L3	
3/4 Boundary	Sets the level at which PID set 3 changes to PID set 4	Range units		L3	
4/5 Boundary	Sets the level at which PID set 4 changes to PID set 5	Range units		L3	
5/6 Boundary	Sets the level at which PID set 5 changes to PID set 6	Range units		L3	
The boundary parameters do not appear if 'Schedule Type' = 'Set'					
Prop Band 1	Proportional Band Set 1	1 to 9999.9 eng units	20	L1	
Integral 1	Integral Time Set 1	Off to 999.9	360	L1	
Derivative 1	Derivative Time Set 1	seconds or minutes	60	L1	
Cutback Low 1	Cutback Low Set 1	Auto to		L1	
Cutback High 1	Cutback High Set 1	display range		L1	
Manual Reset 1 Note 1	Manual Reset Set 1 (only applies to a PD controller)	Off, -100.0 to +100.0		L1	
Cool Gain 1	Relative cool gain set 1	0.1 to 10	1	L1	
An Value 1	Analogue value (set 1)				
OP Hi Limit 1	Output high limit 1	± 100			
OP Lo Limit 1	Output low limit 1	± 100			
The above ten parameters are repeated for sets 2 to 6 if the number of PID sets has been configured to 2 to 6 respectively.					

Note: Autodroop Compensation is used when the integral term is set to 'Off'. Under these conditions the controller will reach a steady state but is likely to control with an error.

When 'Autodroop Compensation' = 'Manual' the 'Manual Reset' parameter can be adjusted to compensate. The effect is to add or subtract a small amount of power manually into the load or actuator.

When 'Autodroop Compensation' = 'Calc' a value is calculated for the 'Manual Reset' which automatically sets the power level. Note that this is a 'snapshot' taken at a particular control point. If the SP is changed, however, the 'Manual Reset' will re-calculate.

Autodroop Compensation may be used in systems which have a very long time of response where it may not be possible to set a long enough integral time constant. Such systems usually operate at a fixed set of conditions so that a once only calculation or manual setting of the 'Manual Reset' can be acceptable.



Manual Reset should be set to 0 when the integral term is set to a value.

PID (Aux) Parameters

Table 33:	These parameters allow you to configure PID sets		<i>LP1 SETUP</i> PID(Aux) Page	
Parameter Name	Parameter Description	Value	Default	Access Level
Rem Sched IP	Remote input Only shown if Schedule Type = Rem Sched IP	Display range		L3
Control Hold	Aux. Control hold flag. Freezes the control output	No Yes		L3
Integral Hold	Aux. Integral hold flag	No Yes		L3
Schedule Type	Scheduling type	As main loop		Conf
Num of Sets	Number of PID sets to use	1 to 3		Conf
Active PID Set	The PID set in current use	PID set 1 - 3		L1
Active An Val	Active analogue value			R/O L3
1/2 Boundary	Sets the level at which PID set 1 changes to PID set 2	Range units		L3
2/3 Boundary	Sets the level at which PID set 2 changes to PID set 3	Range units		L3
The boundary parameters do not appear if 'Schedule Type' = 'Set'				
Prop Band 1	Proportional Band Set 1	1 to 9999.9 eng units	20	L1
Integral 1	Integral Time Set 1	Off to 999.9	360	L1
Derivative 1	Derivative Time Set 1	seconds or minutes	60	L1
Cutback Low 1	Cutback Low Set 1	Auto to display limit		L1
Cutback High 1	Cutback High Set 1			L1
Manual Reset 1	Manual Reset Set 1 (only applies to a PD controller)	Off, -100.0 to +100.0		L1
Cool Gain 1	Relative cool gain set 1 Only present if ch 1 and ch 2 are configured in the same loop	0.1 to 10	1	L1
An Value 1	Analogue value Set 1	Display range		
OP Hi Limit 1	Output high limit 1	± 100		
OP Lo Limit 1	Output low limit 1	± 100		
The above ten parameters are repeated for set 2 and again for set 3 if the number of PID sets has been configured to 2 or 3 respectively.				

This table does not appear if the Loop Type is Single or Ratio.

These tables are repeated for *Loop 2* and *Loop 3* if these have been configured.

Output Parameters

Typically the output(s) of the PID function block are wired to:

- The standard relay or logic outputs, configured for on/off or time proportioning pulses
- Relay, triac or logic output module, configured for on/off or time proportioning pulses
- Analogue output module, configured for Volts or mA

Table of Output Parameters

Table 34:		This list allows you to set up the parameters which control the output to the plant		LP1 SETUP (Output Page)	
Parameter Name	Parameter Description	Value	Default	Access Level	
Loop Mode	Allows the controller to be switched into manual	Auto Manual			
OP Low Limit	Sets a low limit on an analogue output signal	-100% to 100%		L3	
OP High Limit	Sets a high limit on an analogue output signal	-100% to 100%	100	L3	
OP Rate Limit	Sets the rate at which the output value changes	Off to 99.99 %/sec		L3	
OP Rate Lim En	Output rate limit enable	Off On	Off	L3	
Forced OP	Sets the output value when the controller is in manual - alternative to bumpless transfer	-100% to 100%		L3	
SBrk OP	Sets the level of the output in sensor break	-100% to 100%		L3	
CH1 OP	Reads the current value of channel 1 output	-100% to 100%		R/O	
Ch1 Hysteresis	Only shown if the output relay 1 is configured as on/off. It sets the difference between relay on and relay off.	Off to 9999.9		L3	
Ch1 Min Pulse	Output minimum on time (on/off control)			L3	
The above three parameters are repeated for channel 2					
Deadband On/Off control only	Deadband between ch1 and ch2. Only applies if both ch1 and ch2 are configured	Off to 100.0		L3	
Target OP	Target output power	-100 to 100%		L1	
Rem Lo OP Lim	Remote low power limit	-100% to 100%		L3	
Rem Hi OP Lim	Remote high power limit	-100% to 100%		L3	
Power FF Val	Current value of power feedforward			L3	
Ena OP Track	Output track enable	No Yes		L3	
OP Track Value	Track input			L3	
Ena Aux OP Trk	Auxiliary Output track enable	No Yes		L3	
Aux OP Track	Auxiliary Track input	Display range		L3	

Motorised Valve Control

The 2704 controller can be used for motorised valve control as an alternative to the standard PID control algorithm. This algorithm is designed specifically for positioning motorised valves. It operates in boundless or bounded mode as configured by the 'Control Type' parameter in section Loop Set Up (Options Page). Boundless VP control does not require a position feedback potentiometer for control purposes. Bounded VP control requires a feedback potentiometer as part of the control algorithm. Note, however that a potentiometer may be used with boundless mode but it is used solely for indication of the valve position and is not used as part of the control algorithm. The control is performed by delivering a 'raise' pulse, a 'lower' pulse or no pulse at all in response to the control demand signal via raise and lower relay or triac outputs.

Motor Parameters

Table 35:		This list allows you to set up the motor interface parameters for a valve positioning output.		LP1 SETUP (Motor Page)	
		This page only appears if a motor valve positioning output is configured. See Section Loop Set Up (Options Page). (Control Type)			
Parameter Name	Parameter Description	Value	Default	Access Level	
Travel Time	This parameter is set to match the time taken for the motor to travel from fully closed to fully open	0:00:00.1	0:01:00:0	L3	
Inertia	This parameter is set to match the inertia (if any) of the motor	Off to 0:00:00.1	0:00:20:0	L3	
Backlash	This parameter compensates for any backlash which may exist in the linkages	Off to 0:00:00.1	0:00:20:0	L3	
Min Pulse Time	Sets the minimum on time of the signal which drives the motor	Auto to 0:00:00.1	Auto = 0:00:00:2	L3	
VP Pot Lo Lim ⁽¹⁾	Adjusts the valve position low limit in bounded mode set by the potentiometer	0 to 100%	0%	L3	
VP Pot Hi Lim ⁽¹⁾	Adjusts the valve position high limit in bounded mode set by the potentiometer	0 to 100%	100%	L3	
VP SBrk OP	Sets the action of the valve in boundless mode Only appears in boundless mode, i.e. 'Control Type' = VP-Ch1 Only	VP Pos Lo to VP Pos Hi		L3	
VP SBrk Action	Sets the action of the valve if the potentiometer becomes disconnected in bounded mode	Rest Up Down		L3	
Valve Position	Indicates the position of the valve	0 to 100%		R/O	
Enable Pot Cal ⁽¹⁾	Pot input calibration enable	Off On	Off	L3	

Note

These three parameters are only displayed if the potentiometer is soft wired, i.e. 'Pot IP Src' is wired to a parameter.

Diagnostics

Diagnostic parameters are available at all levels, are read only and provide information on the current operating conditions of the controller.

Diagnostic Page

Table 36:		This list allows you to interrogate operating conditions of the loop		LP1 SETUP (Motor Page)	
Parameter Name	Parameter Description	Value	Default	Access Level	
LP 1 PV	Process Variable	Display range		L3	
LP1A PV	Auxiliary Process Variable			L3	
Working SP	The value of the working setpoint			L3	
Working OP	The value of the working output	-100 to 100		L3	
Error	Value of main loop error (PV - SP)	Display range		L3	
Aux Error	Value of the auxiliary loop error (PV - SP)	-9999 to 9999		R/O	
P OP	Proportional component of the output	-999 to 9999		R/O	
Aux P OP	Proportional component of the auxiliary loop output	-999 to 9999		R/O	
I OP	Integral component of the output	-999 to 9999		R/O	
Aux I OP	Integral component of the auxiliary loop output	-999 to 9999		R/O	
D OP	Derivative component of the output	-999 to 9999		R/O	
Aux D OP	Derivative component of the auxiliary loop output	-999 to 9999		R/O	
FF OP	Feedforward component of output	-9999 to 9999		R/O	
SRL Complete	Setpoint rate limit complete			R/O	
VP Velocity	VP output velocity	-100 to 100		R/O	
Loop Brk Stat	Loop break status flag	No Yes		R/O	
Ext FBack	External Feedback			R/O	
Aux Ext FBack	Auxiliary External Feedback			R/O	

Display

The Summary Page, displayed in Operation levels, (see the Navigation Diagram, section Navigation Overview) consists of up to 10 parameters which are in common use on a particular process. These parameters are 'promoted' to this display using the following table.

Display Page

Table 37:		This list configures the Loop Summary display.		LP1 SETUP (Display Page)	
Parameter Name	Parameter Description	Value	Default	Access Level	
Loop Name	Loop name chosen from User Text, see Section Instrument User Text Page.	Default Text or 01 to 50 User Text	Default Text	Conf	
Graph Low	Sets the lower limit on the trend plot	Display Range		L3	
Graph High	Sets the upper limit on the trend plot	Display Range		L3	
Param Promote	Selects the parameter which is to be promoted to the Summary Page.	1 to 10		Conf	
Param Address	The modbus address of the parameter selected by 'Param Promote'. See Appendix D (32.1)	Modbus address		Conf	
Param Name	A name can be selected from User Text (see section Instrument User Text Page) and replaces the number of the 'Param Promote' parameter.	Default Text or 01 to 50 User Text		Conf	
Param Access	Sets the read/write access level of the 'Param Promote' parameter.	Lev 1 Read Only Lev 1 Alterable Lev 2 Read Only Lev 2 Alterable		Conf	
Parameters which have been promoted using 'Param Promote' are listed at the end of this table as a preview of those which will appear in the Summary page in operation levels.					

Cascade Control

Overview

Cascade control is classified as an advanced control technique used, for example, to enable processes with long time constants to be controlled with the fastest possible response to process disturbances, including setpoint changes, whilst still minimising the potential for overshoot. It is a combination of two PID controllers, where the output signal from one (the master) forms the setpoint for the other (the slave). For cascade control to be effective the slave loop should be more responsive than the master.

Full Scale Cascade Mode

An example of Full Scale Cascade Mode is shown in Figure 50. A controller, the slave, regulates the fuel flow to a furnace. A second controller, the master, measures the temperature but, instead of regulating the valve, it regulates the setpoint of the flow controller. In full scale mode the scaling is such that the master is allowed to adjust the slave by 0-100%.

Remote feedforward is a user defined, wireable parameter. It may be used if there is a requirement for some additional parameter, for example an analogue input, to trim the master PID output value before the slave setpoint is applied. An application may be a liquid temperature control system using cascade control of heater temperature where variations in control rate can be directly fed forward into the slave loop, modifying heater temperature and giving rapid compensation

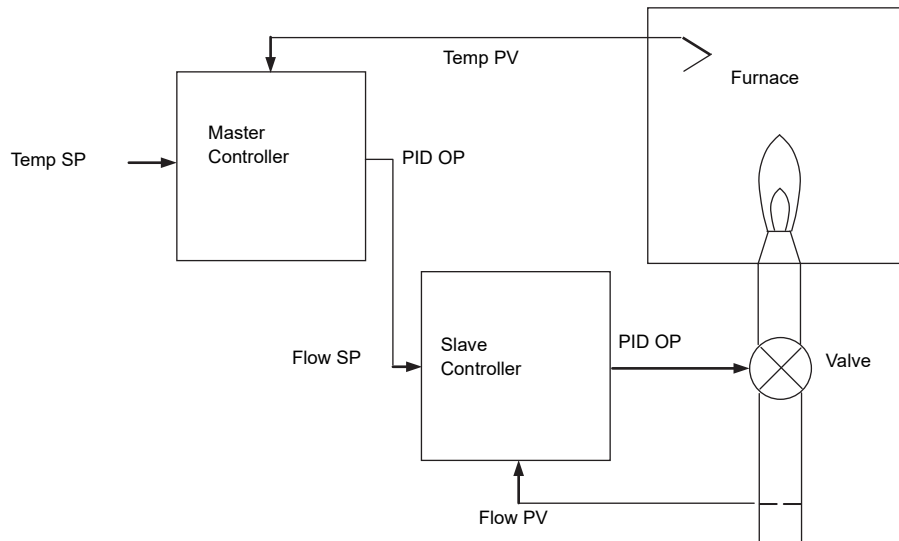

Figure 50 Full Scale Cascade Control

Trim Mode

In this example the slave controls the temperature within a furnace. The master is measuring the temperature of the workpiece and controlling the temperature of the slave. In this case the master trims the setpoint of the slave rather than controlling it directly. By limiting the amount of trim the temperature of the furnace will remain within bounds.

Feedforward allows either the master PV, master SP or a user defined variable (CSD FFwd Src) to be fed forward so that it directly influences the slave setpoint.

A typical application for SP feedforward could be in a heat treatment furnace, where it can be used to extend the life of heating elements by limiting their maximum operating temperature.

An application using PV feedforward could be in autoclaves or reactor vessels where it is sometimes required to protect the product from excessive temperature gradients (also referred to as Delta T Control). The effect of this is to limit the furnace temperature to a band around the target temperature.

Feedforward can also be a user defined variable in trim mode in the same way as full scale mode.

The implementation of cascade control in the 2704 is available as a standard option. ie it is not necessary to order a dual loop controller to perform cascade control.

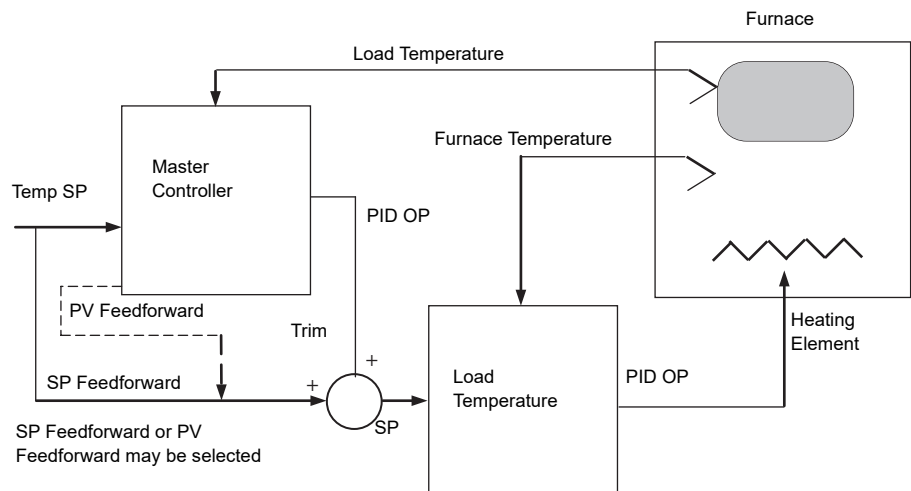

Figure 51 Cascade Trim Control

Auto/Manual Operation in Cascade

There are three modes of operation:

Manual – manual control of the actual output

Auto – Slave operates in automatic with local setpoint

Cascade – Master controls the slave setpoint. Slave is in auto.

When the controller is placed in manual the slave working setpoint will track the value of the slave process value continually, therefore ensuring bumpless transfer.

When cascade is deactivated the master loop will monitor the setpoint of the slave loop and provide a smooth transition of output power when the loop moves back to cascade mode.

Cascade Controller Block Diagrams

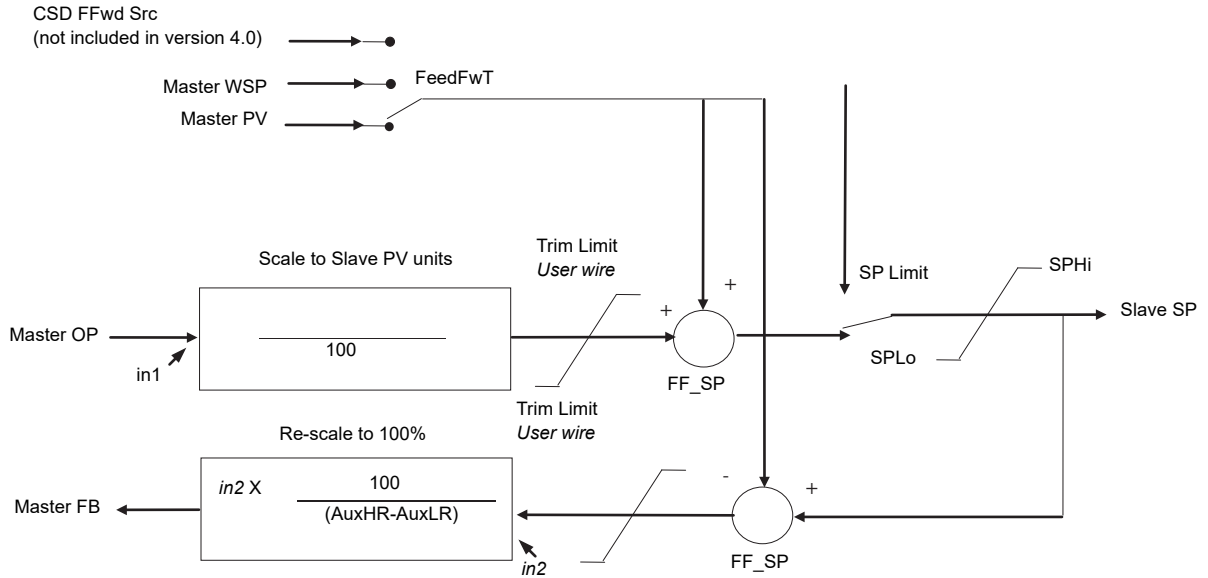

Note: This diagram applies to controllers with software version 4.0 or greater. For earlier versions, see Appendix E.

Figure 52 Cascade Controller in Trim Mode

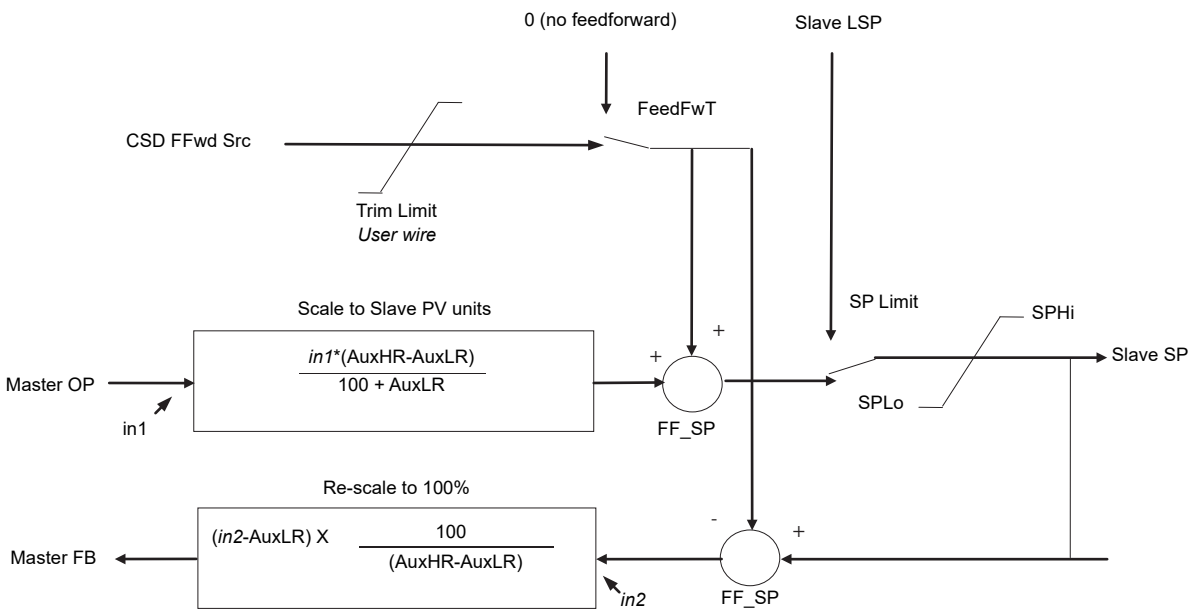

Figure 53 Cascade Controller in Full Scale Mode

Loop Setup (Wiring Page) for Cascade Loop

A controller is configured for cascade operation if 'Loop Type'= 'Cascade' in 'LOOP SETUP(Options)' page, (section Loop Set Up (Options Page)).

Table 38:		These parameters allow you to soft wire between function blocks.		LP1 SETUP Wiring Page	
Parameter Name	Parameter Description	Value	Default	Access Level	
PV Src	Process variable source	Modbus address	05108: PVIIn.Val	Conf	
Aux PV Src	Auxiliary PV source	Modbus address		Conf	
Manual OP Sr	Target OP power source	Modbus address		Conf	
OPRtLim En S	OP rate limit enable source	Modbus address		Conf	
Aux LSP Src	Auxiliary local SP source	Modbus address		Conf	
Casc Disable S	Cascade disable source	Modbus address		Conf	
Casc FFwd Src	Casc. feedforward source	Modbus address		Conf	
The above parameter does not appear if FF Type (section Loop Set Up (Options Page)) = None					
Casc TrmLim S	Casc. FF trim limit source	Modbus address		Conf	
Ctrl Hold Src	Freeze control flag source	Modbus address		Conf	
AuxCtrlHold Src	Aux. freeze control flag src	Modbus address		Conf	
Integr Hld Src	Integral hold flag source	Modbus address		Conf	
Aux I Hold Src	Aux. Integral hold flag src	Modbus address		Conf	
Man Mode Src	Auto/manual select source	Modbus address		Conf	
Pot IP Src	Pot position source	Modbus address		Conf	
Rem FFwd Src	Remote feedforward src	Modbus address		Conf	
Rem Hi OP Src	Remote hi power limit src	Modbus address		Conf	
Rem Lo OP Sr	Remote lo power limit src	Modbus address		Conf	
The above two parameters do not appear if Control Type (section Loop Set Up (Options Page)) = On/Off					
Rem SP Ena S	Remote SP enable source	Modbus address		Conf	
Remote SP Sr	Remote setpoint source	Modbus address		Conf	
SP Select Sr	Internal SP select source	Modbus address		Conf	
SP1 Src	Setpoint 1 source	Modbus address		Conf	
SP2 Src	Setpoint 2 source	Modbus address		Conf	
Rt Lim Dis Src	SP rate limit disable source	Modbus address		Conf	
Rt Lim Hld Src	SP rate limit hold source	Modbus address		Conf	
Prog SP Src	LP1 PSP wire source	Modbus address		Conf	
PID Set Src	PID Set Source	Modbus address		Conf	
Aux PID Set S	Auxiliary PID Set Source	Modbus address		Conf	
Power FF Src	Power feedforward source	Modbus address		Conf	
Track Enab S	OP track enable source	Modbus address		Conf	
Track Src	Track output source	Modbus address		Conf	
Aux Trk En S	Aux. OP track enable src	Modbus address		Conf	
Aux Trk Src	Aux. track output source	Modbus address		Conf	
Ext FBack Src	External feedback source	Modbus address		Conf	
AuxExtFBck Src	Auxiliary external feedback source	Modbus address		Conf	

Cascade Parameters

Table 39:		This list only appears if cascade is configured, (see section Loop Set Up (Options Page)) and allows you to set up parameters specific to cascade controllers.		LP1 SETUP (Cascade Page)	
Parameter Name	Parameter Description	Value	Default	Access Level	
Cascade Mode	Cascade Mode	Full Scale FF Full Scale Trim PV FF Trim SP FF		Conf	
Disable CSD	Cascade disable status. (It is sometimes useful to disable cascade when starting a process. This also returns the controller to single loop control using the local SP.)	Off On		L1.	
CSD TrimLo	Cascade low trim limit				
CSD TrimHi	Cascade high trim limit				
CSD FF Value	Cascade feedforward value i.e. The value being fed forward	Range of signal being fed forward		L3	
Work FF Value	Working feedforward value			R/O	
Master FB	Cascade master PID feedback value	Range of slave loop		R/O	

Cascade Wiring Example

This example shows how to configure Loop 1 to be a simple cascade controller. The master PV is connected to the Main PV input and the slave PV is connected to a PV Input module fitted in Slot 3. The control output is a 4-20mA signal which uses a DC control module fitted in Slot 1.

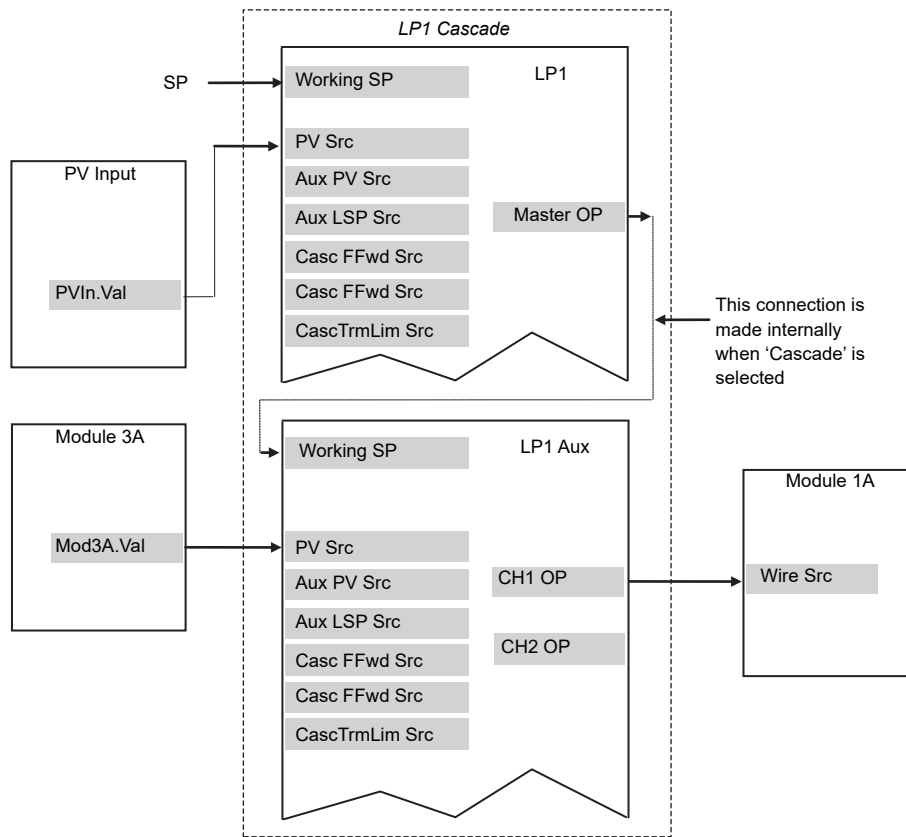

Figure 54 Wiring for Simple Cascade Control Loop

Implementation

- | | |
|--|--|
| <p>1. In LP1 SETUP / Options Page (section Loop Set Up (Options Page)),</p> | <p>set 'Loop Type' = Cascade</p> |
| <p>2. In LP1 SETUP / Wiring Page (section Loop Setup (Wiring Page) for Cascade Loop)</p> | <p>set 'PV Src' = 05108: PVIn.Val (Appendix D)
 <i>This connects the PV input to the master PV of the cascade loop</i></p> |
| <p>3. In LP1 SETUP / Wiring Page (section Loop Setup (Wiring Page) for Cascade Loop)</p> | <p>set 'Aux PV Src' = 04468: Mod3A.Val (Appendix D)
 <i>This connects the PV input from Module 3 to the slave PV of the cascade loop</i></p> |
| <p>4. In MODULE IO / Module 1 A Page (section DC Control and DC Retransmission)</p> | <p>set 'Wire Src' = 00013: L1.Ch1.OP (Appendix D)
 <i>This connects channel 1(heat) control to the DC output module</i></p> |

See Appendix D for list of Modbus addresses.

☺:- See 'Copy and Paste' description in Soft Wiring.

Ratio Control

Overview

Ratio Control is a technique used to control a process variable at a setpoint which is calculated as a proportion of a second (lead) input. The ratio setpoint determines the proportion of the lead value that is to be used as the actual control setpoint. The ratio setpoint can be applied as either a multiplier or as a divisor to the second input.

A typical application is in gas fired furnaces where in order to achieve efficient combustion, the gas and air flow supplied to the burners needs to be maintained at a constant ratio.

Basic Ratio Control

The 2704 contains a ratio control function block which can be used in any control loop. Figure 55 shows a block diagram of a simple ratio controller. The lead PV is multiplied or divided by the ratio setpoint to calculate the desired control setpoint. Prior to the setpoint calculation, the ratio setpoint can be offset by the ratio trim value and must obey the overall ratio setpoint operating limits. Another useful feature of the is the automatic calculation of the actual measured ratio which is then available to be displayed on the controller front panel.

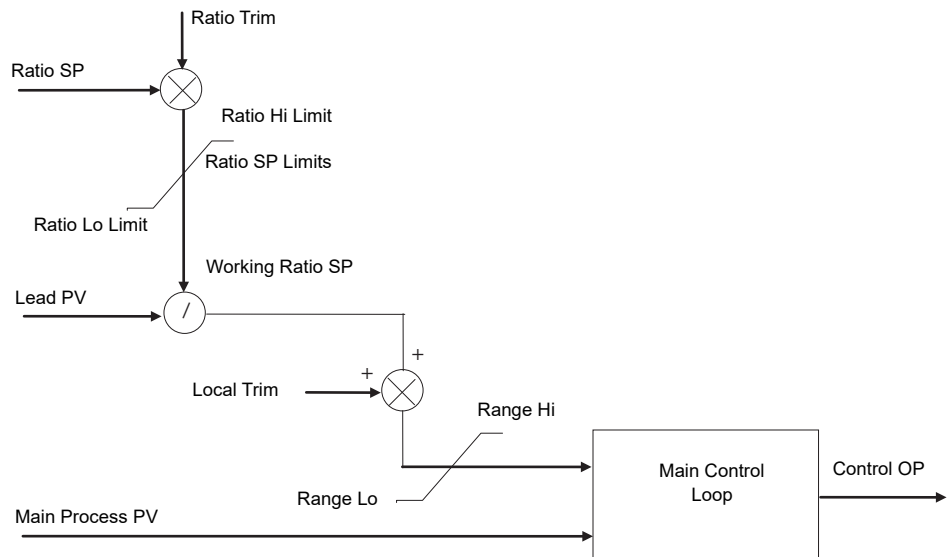

Figure 55 Simple Ratio Control Block Diagram

The measured ratio is calculated from the Lead PV and the Process PV. It is also possible to enable 'Ratio Track'. If 'Enable Ratio' is set to 'Off' and Ratio Track is set to 'On', then the Ratio SP will track the measured ratio. This feature allows the user to set the Ratio SP according to the condition of the process.

Controller Configured for Ratio

A controller is configured for ratio operation if 'Loop Type'= 'Ratio' in 'LOOP SETUP(Options)' page, (section Loop Set Up (Options Page)).

Table 40:		These parameters allow you to soft wire between function blocks.		LP1 SETUP Wiring Page	
Parameter Name	Parameter Description	Value	Default	Access Level	
PV Src	Process variable source	Modbus address	05108: PVIIn.Val	Conf	
Manual OP Sr	Target OP power source	Modbus address		Conf	
OPRtLim En S	OP rate limit enable src	Modbus address		Conf	
Lead PV Src	Lead PV source	Modbus address		Conf	
Ratio SP Src	Ratio setpoint source	Modbus address		Conf	
Ratio Trim Src	Ratio trim source	Modbus address		Conf	
Ratio Enab Src	Ratio enable source	Modbus address		Conf	
Ctrl Hold Src	Freeze control flag source	Modbus address		Conf	
Integr Hld Src	Integral hold flag source	Modbus address		Conf	
Man Mode Src	Auto/manual select source	Modbus address		Conf	
Pot IP Src	Pot position source	Modbus address		Conf	
Rem FFwd Sr	Remote feedforward src	Modbus address		Conf	
Rem Hi OP Src	Remote high power limit src	Modbus address		Conf	
Rem Lo OP Src	Remote low power limit src	Modbus address		Conf	
The above two parameters do not appear if Control Type (section Loop Set Up (Options Page)) = On/Off					
Rem SP Ena S	Remote SP enable source	Modbus address		Conf	
Remote SP Sr	Remote setpoint source	Modbus address		Conf	
SP Select Sr	Internal SP select source	Modbus address		Conf	
SP1 Src	Setpoint 1 source	Modbus address		Conf	
SP2 Src	Setpoint 2 source	Modbus address		Conf	
Rt Lim Dis Src	SP rate limit disable src	Modbus address		Conf	
Rt Lim Hld Src	SP rate limit hold source	Modbus address		Conf	
Prog SP Src	LP1 PSP wire source	Modbus address		Conf	
PID Set Src	PID Set Source	Modbus address		Conf	
Power FF Src	Power feedforward source	Modbus address		Conf	
Track Enab S	OP track enable source	Modbus address		Conf	
Track Src	Track output source	Modbus address		Conf	
Ext FBack Src	External feedback source	Modbus address		Conf	

Ratio Parameters

Table 41:	This list only appears if ratio is configured (see section Loop Set Up (Options Page)) and allows you to set up parameters specific to ratio controllers.		LP1 SETUP (Ratio Page)	
Parameter Name	Parameter Description	Value	Default	Access Level
Ratio Resol	Ratio display resolution	XXXXX XXXX.X XXX.XX XX.XXX		Conf
Ratio Type	Ratio type	Divide Multiply		Conf
Lead PV	The value of the lead process variable			L1
Measured Ratio	Measured Ratio			R/O
Work Ratio SP	Ratio working setpoint			R/O
Ratio Lo Lim	Ratio setpoint low limit			L3
Ratio SP	Ratio setpoint			L3
Ratio Trim	Ratio trim value			L1
Enable Ratio	Ratio enable	Off On		L1
Ratio Track	Ratio track mode	Off On		Conf

Ratio Wiring Example

This example shows how to configure Loop 1 to be a simple ratio controller. The main PV is connected to the PV Input (rear terminals V+ & V-) and the lead PV is connected to the Analogue Input (rear terminals BA & BB). The control output is a valve position signal which uses a dual triac control module fitted in Slot 1.

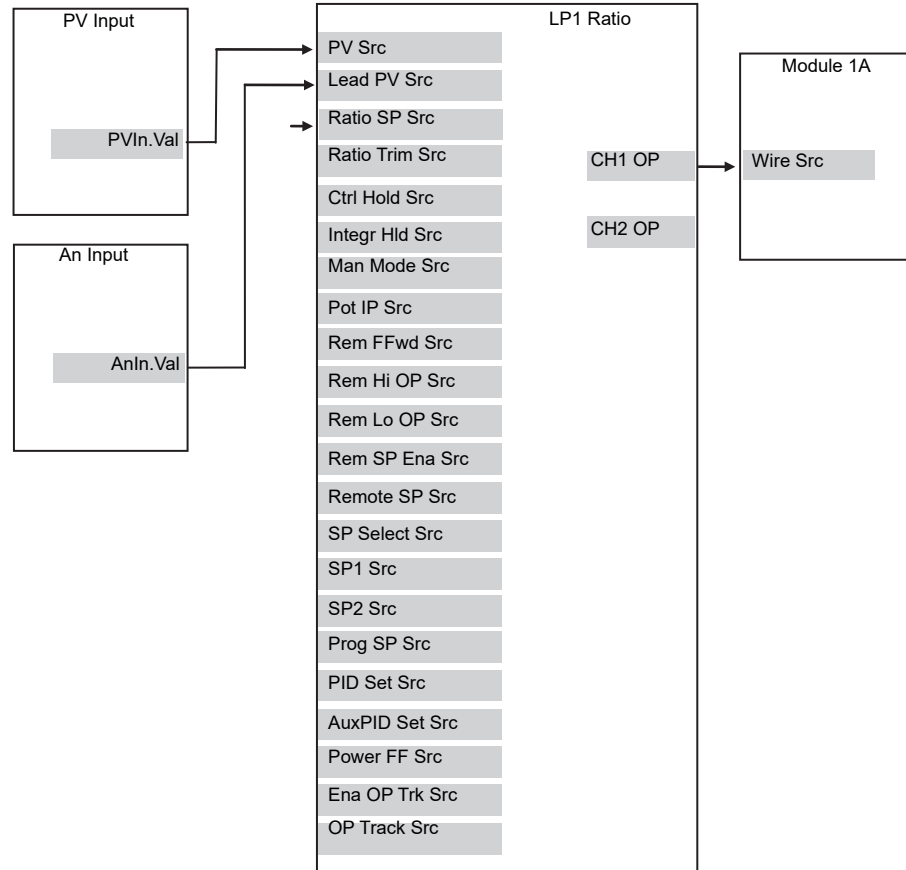

Figure 56 Wiring for Simple Ratio Control Loop

Implementation

1. In LP1 SETUP / Options Page (section Loop Set Up (Options Page)), set 'Loop Type' = Ratio
2. In LP1 SETUP / Ratio Page (section Ratio Parameters), set 'Enable Ratio' = On
Set other parameters as required
3. In LP1 SETUP / Wiring Page (section Controller Configured for Ratio) set 'PV Src' = 05108: PVIn.Val (Appendix D)
This connects the PV input to the main PV of the ratio loop
4. In LP1 SETUP / Wiring Page (section Controller Configured for Ratio) set 'Lead PV Src' = 05268: AnIn.Val (Appendix D)
This connects the lead PV input of the ratio loop from Analogue Input
5. In MODULE IO / Module 1 A Page (section Triac Output) set 'Wire Src' = 00013: L1.Ch1.OP (Appendix D)
This connects channel 1(heat) control to the Dual Triac output module

See Appendix D for list of Modbus addresses.

☺: See 'Copy and Paste' description in Soft Wiring.

Override Control

Overview

Override Control allows a secondary control loop to override the main control output in order to prevent an undesirable operating condition. The override function can be configured to operate in either minimum, maximum or select mode.

A typical example can be implemented in a heat treatment furnace with one thermocouple attached to the workpiece, and another situated close to the heating elements. Control of the furnace during the heating up period is regulated by the override (heating element) temperature controller which provides a safeguard against overheating. Control of the furnace will switch over to the workpiece temperature controller at some point when the temperature is near to its target setpoint. The exact point of switchover is determined automatically by the controller, and will be dependent on the selected PID terms.

Simple Override

Override control is available with analogue, time proportioning and ON/OFF control outputs. It is not available with valve position outputs. Figure 57 shows a simple override control loop. The main and override controller outputs are fed to a low signal selector. The override controller setpoint is set to a value somewhere above the normal operating setpoint, but below any safety interlocks.

There is only one Auto Manual switch for both loops. In manual mode the control outputs of both loops track the actual output, ensuring bumpless transfer when auto is selected. The transfer between main and override PID control is also bumpless.

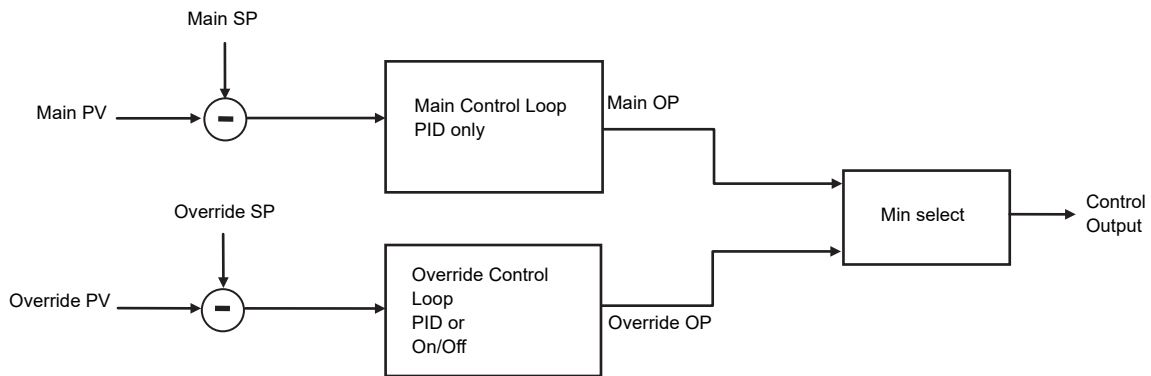

Figure 57 Simple Override Control (Select Minimum)

Sensor Break Action

As from firmware version 6.10 the action of the control loops during sensor break will be determined by the Sensor Break Type parameter (Sbrr).

Sensor Break Type = Output (0)

In this mode then no matter which sensor fails the output will go to the Sensor Break Power (oSbOP).

Sensor Break Type = Hold (1)

In this mode the action is dependent on whether the loop to which the sensor is attached is the controlling loop. If it is the controlling loop then the output will hold at its current value and override action is suspended. If it is the loop not currently in control then the controlling loop will continue controlling.

Issues with Sensor Break

A **PV** or **Analogue Input** can be set up to have a sensor break fall back vale (InpClp) of Up Scale (2) or Down Scale (1). On 2000 series controllers the break impedance is measured with an AC signal. For the short period until the break condition is detected the value of the input can drift.

This can produce an undesirable effect with override control if the drifting signal causes the override to switch loops.

To ensure that any initial drift is in the correct direction it may be necessary to fit a resistor to the sensor input terminals. The terminals used will be dependent on whether the signal is required to go downscale or upscale as follows:

Downscale

Fitting a resistor across the sense terminals V+ and V- will cause the temperature reading to collapse towards ambient when the sensor is broken. A value between 100K and 10M can be used with little effect to the normally displayed value.

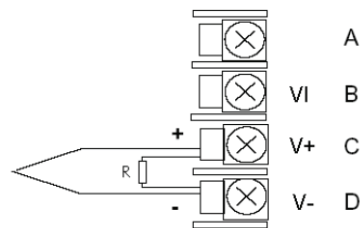

Upscale

Fitting a resistor across the sense terminals VI and V+ will cause the temperature reading to rise when the sensor is broken. Due to the sensor wire resistance being as much as 22R the temperature reading will be sensitive to the value of R.

A value of 10M will add 5.5uV to the reading. This could produce an offset of between 0.1°C and 1°C but is dependent on thermocouple type and actual temperature. As this is a small fixed offset for a given reading, the 'Offset' parameter of the input block could be used to cancel it if necessary.

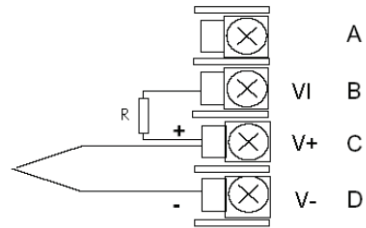

Controller Configured For Override

A controller is configured for override operation if 'Loop Type'= 'Override' in 'LOOP SETUP(Options)' page, (section Loop Set Up (Options Page)).

Table 42:		These parameters allow you to soft wire between function blocks.		LP1 SETUP Wiring Page	
Parameter Name	Parameter Description	Value	Default	Access Level	
PV Src	Process variable source	Modbus address	05108: PVIIn.Val	Conf	
Aux PV Src	Auxiliary PV source	Modbus address		Conf	
Manual OP Sr	Target OP power source	Modbus address		Conf	
OPRtLim En S	OP rate limit enable src	Modbus address		Conf	
Aux LSP Src	Auxiliary local SP source	Modbus address		Conf	
Ctrl Hold Src	Freeze control flag source	Modbus address		Conf	
AuxCtrlHold Sr	Aux freeze control flag src	Modbus address		Conf	
Integr Hld Sr	Integral hold flag source	Modbus address		Conf	
Aux I Hold Sr	Aux. Integral hold flag src	Modbus address		Conf	
Man Mode Sr	Manual mode source	Modbus address		Conf	
Active Lp Sr	Active loop source	Modbus address		Conf	
OVR Disab Sr	Override disable source	Modbus address		Conf	
OVR Trim Src	Override trim source	Modbus address		Conf	
Pot IP Src	Pot position source	Modbus address		Conf	
Rem FFwd Sr	Remote feedforward src	Modbus address		Conf	
Rem Hi OP Src	Remote hi power limit src	Modbus address		Conf	
Rem Lo OP Sr	Remote lo power limit src	Modbus address		Conf	
The above two parameters do not appear if Control Type (section Loop Set Up (Options Page)) = On/Off					
Rem SP Ena S	Remote SP enable source	Modbus address		Conf	
Remote SP Sr	Remote setpoint source	Modbus address		Conf	
SP Select Sr	Internal SP select source	Modbus address		Conf	
SP1 Src	Setpoint 1 source	Modbus address		Conf	
SP2 Src	Setpoint 2 source	Modbus address		Conf	
Rt Lim Dis Src	SP rate limit disable src	Modbus address		Conf	
Rt Lim Hld Src	SP rate limit hold source	Modbus address		Conf	
Prog SP Src	LP1 PSP wire source	Modbus address		Conf	
PID Set Src	PID Set Source	Modbus address		Conf	
Aux PID Set S	Auxiliary PID Set Source	Modbus address		Conf	
Power FF Src	Power feedforward source	Modbus address		Conf	
Track Enab S	OP track enable source	Modbus address		Conf	
Track Src	Track input source	Modbus address		Conf	
Ext FBack Src	External feedback source	Modbus address		Conf	
AuxExtFBck Src	Auxiliary external feedback source	Modbus address		Conf	

Override Parameters

Table 43:	This list only appears if override is configured (see section Loop Set Up (Options Page)) and allows you to set up parameters specific to override controllers		LP1 SETUP (Override Page)	
Parameter Name	Parameter Description	Value	Default	Access Level
Override Type	Override type See Note 1	Minimum Maximum Select		Conf
OVR Target SP	Override target setpoint	Display range		
Disable OVR	Disable override control. See Note 2.	No Yes		L1
Active Loop	Displays the loop which is controlling at any time			L1
OVR SP Trim	Override loop setpoint trim	Range limit		L1
Main OP	Override main output	-100 to 100		R/O
Override OP	Override output	-100 to 100		R/O

Note 1:

Minimum selects the lowest output power from the two loops to be the control output.

Maximum selects the highest output power from the two loops to be the control output.

Select allows either the main output or the override output to be used as the control output depending on the state of a digital input or via digital communications.

Note 2:

The main control loop is active when Override control is disabled.

Override Wiring Example

This example shows how to configure Loop 1 to be a simple override furnace temperature controller. The main PV is connected to the PV Input (rear terminals V+ & V-) and the override PV is connected to a PV Input module fitted in slot 3 (rear terminals 3C & 3D). The control output is an analogue control module fitted in Slot 1.

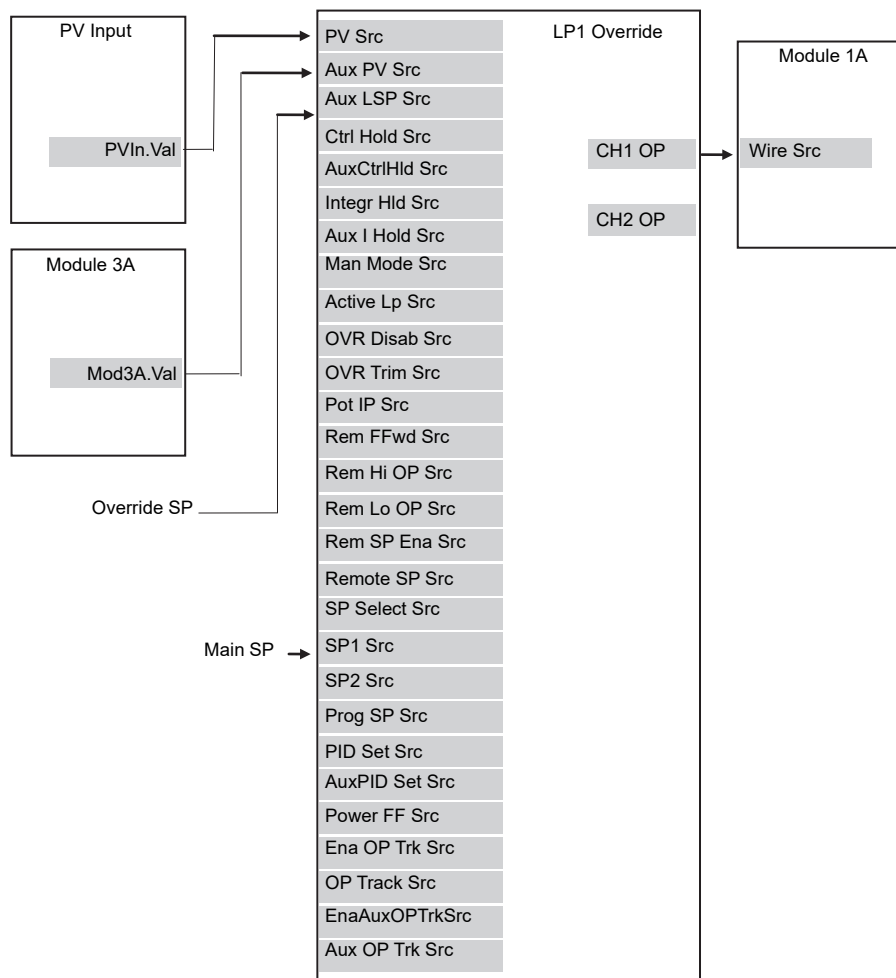

Figure 58 Wiring for Simple Override Control Loop

Implementation

1. In LP1 SETUP / Options Page (section Loop Set Up (Options Page)), set 'Loop Type' = Override
This action also connects the main SP and override SP to SP1 and SP2 respectively.
2. In LP1 SETUP / Override Page (section Override Parameters) set 'Override Type' = Minimum
Set other parameters as required
3. In LP1 SETUP / Wiring Page (section Loop Set Up (Wiring Page) Single Loop) set 'PV Src' = 05108: PVIn.Val (Appendix D)
This connects the PV input to the main PV of the override loop
4. In LP1 SETUP / Wiring Page (section Loop Set Up (Wiring Page) Single Loop) set 'Aux PV Src' = 04468: Mod3A.Val (Appendix D)
This connects the override PV input of the override loop from Analogue Input
5. In MODULE IO / Module 1 A Page (section DC Control and DC Retransmission) set 'Wire Src = 00013: L1.Ch1.OP (Appendix D)
This connects channel 1(heat) control to the Analogue output module

See Appendix D for list of Modbus addresses.

☺: See 'Copy and Paste' description in Soft Wiring.

Loop2 Set Up

All pages listed in the previous sections are repeated for Loop 2.

Loop3 Set Up

All pages listed in the previous sections are repeated for Loop 3.

Tuning

This chapter describes how to tune your controller to match the characteristics of the process under control.

There are five topics:

- WHAT IS TUNING?
- AUTOMATIC TUNING
- MANUAL TUNING
- GAIN SCHEDULING
- TUNING OF CASCADE LOOPS

This chapter should be read in conjunction with Loop Set Up.

What is Tuning

In tuning, you match the characteristics of the controller to those of the process being controlled in order to obtain good control. Good control means:

- Stable, 'straight-line' control of the PV at setpoint without fluctuation
- No overshoot, or undershoot, of the PV setpoint
- Quick response to deviations from the setpoint caused by external disturbances, thereby rapidly restoring the PV to the setpoint value.

Tuning involves calculating and setting the value of the parameters listed in Table 44. These parameters appear in the *Loop Setup* (PID) list, see *Loop Set Up*.

Parameter	Meaning or Function
Proportional band	The bandwidth, in display units or %, over which the output power is proportioned between minimum and maximum.
Integral time	Determines the time taken by the controller to remove steady-state error signals.
Derivative time	Determines how strongly the controller will react to the rate-of-change of the measured value.
High Cutback	The number of display units, above setpoint, at which the controller will increase the output power, in order to prevent undershoot on cool down.
Low cutback	The number of display units, below setpoint, at which the controller will cutback the output power, in order to prevent overshoot on heat up.
Cool gain	Only present if cooling has been configured and a module is fitted. Sets the cooling proportional band, which equals the proportional band value divided by the cool gain value.

Table 44: Tuning Parameters

Automatic Tuning

The 2704 controller uses a one-shot tuner which automatically sets up the initial values of the three term parameters.

One-shot Tuning

The 'one-shot' tuner works by switching the output on and off to induce an oscillation in the measured value. From the amplitude and period of the oscillation, it calculates the tuning parameter values.

If the process cannot tolerate full heating or cooling being applied during tuning, then the levels can be restricted by setting the autotune high power limit ('Tune OH') and autotune low power limit ('Tune OL') in the AUTOTUNE parameters page (section Autotune Parameters). These limits are only applied during the autotune process. However, the measured value *must* oscillate to some degree for the tuner to be able to calculate values.









Under normal control the output power limits may be set by 'OP Low Limit' and 'OP High Limit' found in LPx SETUP/Output lists. If these limits are set to a lower value than the autotune limits, then the autotune high and low power limits will be clipped to the output limits as soon as autotune is run.

A One-shot Tune can be performed at any time, but normally it is performed only once during the initial commissioning of the process. However, if the process under control subsequently becomes unstable (because its characteristics have changed), you can re-tune again for the new conditions.

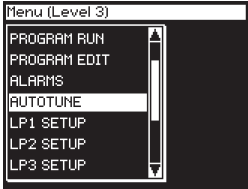
It is best to start tuning with the process at ambient conditions and with the SP close to the normal operating level. This allows the tuner to calculate more accurately the low cutback and high cutback values which restrict the amount of overshoot, or undershoot.

To Autotune Contol Loop Lp1

In most cases it will only be necessary to carry out the Autotune procedure when commissioning your controller.

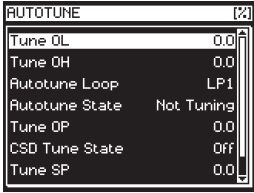
Do This	This Is The Display You Should See	Additional Notes
Set the setpoint to the value at which you will normally operate the process .		
<p>8. From any display press  as many times as necessary to access the page header menu</p> <p>9. Press  or  to select 'AUTOTUNE'</p>		<p>Autotune page is at Level 3 by default, but can be promoted to L1 or L2.</p> <p>See section Instrument Page Promote Page</p>
<p>10. Press  to display sub-headers and again to select 'Tune OL'</p> <p>11. Press  or  to set the minimum power limit during tuning</p> <p>12. Repeat for 'Tune OH'</p> <p>13. Press  to select 'Autotune Loop'</p> <p>14. Press  or  to choose the loop to tune</p>		<p>The choices are:- <i>LP1</i> <i>LP1A</i> <i>LP1 Cascade</i> These are repeated for Loops 2 and 3</p> <p>Note: Text shown in <i>italics</i> is user definable in configuration mode and may be different from that shown</p>

4. The controller induces an oscillation in the PV by first turning the output (power) on, and then off. The power is limited by 'Tune OL' and 'Tune OH'. These two parameters are defaulted to 0 and should be set to values which do not overload the process during tuning. These values are limited by the overall 'OP Low Limit' and 'OP High Limit' set in the Output Page. The first cycle is not complete until the measured value has reached the required setpoint.
5. After two cycles of oscillation the tuning is completed and the tuner switches itself off.
6. When the controller is autotuning the status of autotune is shown periodically on the relevant loop summary
7. The parameter 'Tune SP' is the setpoint value which the controller uses to tune. In a cascade loop this may be derived form the master or slave loops.
8. The parameter 'Stage Time' shows the time spent in any individual stage of the tuning process. If the time in any stage exceeds two hours the auto tune is aborted.
9. The controller then calculates the tuning parameters listed in Table 44 and resumes normal control action.

If you want 'Proportional only', 'PD', or 'PI' control, you should set the Integral time parameter or derivative time parameter to OFF before commencing the tuning cycle. These parameters are found in the *Loop Setup (PID)* pages, see *Loop Set Up*. The tuner will leave them off and will not calculate a value for them.

Typical automatic tuning cycle

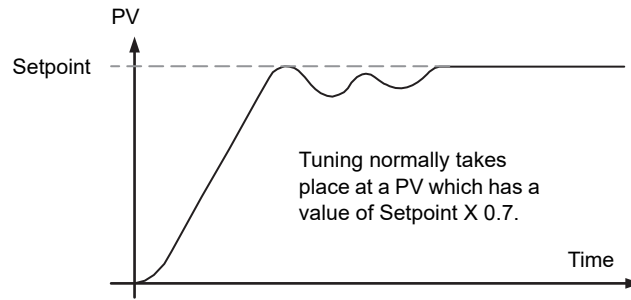

Calculation of the cutback values

Low cutback and *High cutback* are values that restrict the amount of overshoot, or undershoot, that occurs during large step changes in PV (for example, under start-up conditions).

If either low cutback, or high cutback, is set to 'Auto' the values are fixed at three times the proportional band, and are not changed during automatic tuning.

Carbon Potential Control

If the loop is configured for carbon potential control it is necessary to set the proportional band from 'Engineering Units' to 'Percentage' before initiating self tune. This is because the controller requires an error of at least one unit to be able to tune. In the case of carbon potential this signal is very often <1 .

To set Proportional Band in Percentage:

In *LPx* SET UP/Options Page Scroll to 'Prop Bnd Units'

Press or button to select 'Percentage'

For further information see Loop Set Up.

Autotune Parameters

Table 45: These parameters allow you to autotune the loop			AUTOTUNE	
Parameter Name	Parameter Description	Value	Default	Access Level
Tune OL	Auto tune low power limit. Sets a minimum output limit during tuning	-100 to 100%	0	L1
Tune OH	Auto tune high power limit Sets a maximum output limit during tuning	-100 to 100%	0	L1
Autotune Loop	Selects the loop number to tune	LP1 LP1A LP1 (CSD) Repeated for LP2 & LP3		L1
Autotune State	Shows the current state of autotune	Not Tuning Measuring Noise Tuning at SP Tuning to SP Finding Minimum Finding Maximum Storing Time End Calculating PID ABORTED	Not Tuning	L1 R/O
Tune OP	Tune output	-100 to 100		R/O L1
CSD Tune State	Cascade tuning state	Off Initialising Tuning Slave Waiting Waiting Again Tuning Master	Off	L1
Tune SP	The SP selected by the controller at which to tune	Display range		R/O L3
Stage Time	Time spent in an individual stage	0:00:00.0		R/O L3

To View the State of Autotune

As autotune progresses, its state is displayed on the loop overview screen and also in the autotune parameter list as follows.

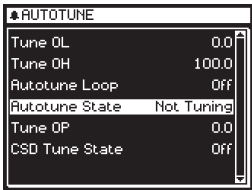
Do This	This Is The Display You Should See	Additional Notes
1. the previous display Press  to display 'Autotune State'		This parameter displays the state of Autotuning. The choices are: Not Tuning Measuring Noise Tuning A at SP Tuning to SP Finding Minimum Finding Maximum Storing Time Calculating PID End ABORTED In the relevant loop summary, a message below the banner is periodically flashed with the loop being tuned. A second message flashes the state of tuning from the text above.

Manual Tuning

If for any reason automatic tuning gives unsatisfactory results, you can tune the controller manually. There are a number of standard methods for manual tuning. The one described here is the Ziegler-Nichols method.

With the process at its normal running conditions:

1. Set the Integral Time and the Derivative Time to OFF.
2. Set High Cutback and Low Cutback to 'Auto'.
3. Ignore the fact that the PV may not settle precisely at the setpoint.
4. If the PV is stable, reduce the proportional band so that the PV just starts to oscillate. If PV is already oscillating, increase the proportional band until it just stops oscillating. Allow enough time between each adjustment for the loop to stabilise. Make a note of the proportional band value 'B' and the period of oscillation 'T'.
5. Set the proportional band, integral time and derivative time parameter values according to the calculations given in the table below.

Type of control	Proportional band (P)	Integral time (I)	Derivative time (D)
Proportional only	2xB	OFF	OFF
P + I control	2.2xB	0.8xT	OFF
P + I + D control	1.7xB	0.5xT	0.12xT

Table 46: Tuning Values

Note: The parameters listed in the above table will be found under the heading Loop Setup. This heading is also described in the following chapter.

Setting The Cutback Values

The above procedure sets up the parameters for optimum steady state control. If unacceptable levels of overshoot or undershoot occur during start-up, or for large step changes in PV, then manually set the cutback parameters.

Proceed as follows:

1. Set the low and high cutback values to three proportional bandwidths (that is to say, $Lcb = Hcb = 3 \times P$).
2. Note the level of overshoot, or undershoot, that occurs for large PV changes (see the diagrams below).

In example (a) increase Low Cutback by the overshoot value. In example (b) reduce Low Cutback by the undershoot value.

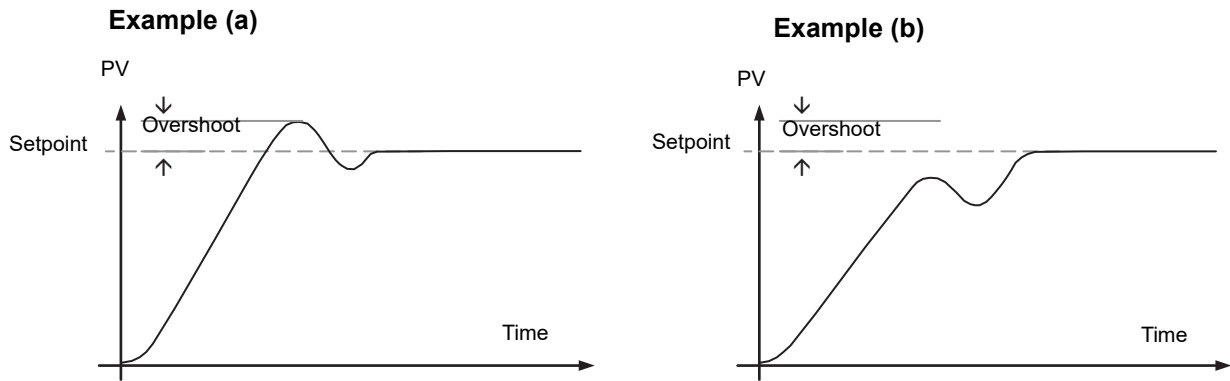

Where the PV approaches setpoint from above, you can set High Cutback in a similar manner.

Integral Action and Manual Reset

In a full three-term controller (that is, a PID controller), the integral term automatically removes steady state errors from the setpoint. If the controller is set up to work in two-term mode (that is PD mode), the integral term will be set to 'OFF'. Under these conditions the measured value may not settle precisely at setpoint. The parameter 'Manual Reset' in the Loop Setup (PID) page is used to compensate for no integral term by providing a small output bleed, and must be set manually in order to remove the steady state error.

Valve Position Control

See section Motorised Valve Control 'Control of Valve Positioning Motors', for an explanation of the additional parameters required for motorised valves and how to set the values of these parameters.

Tuning When Gain Scheduling is Used

Gain scheduling is described in section Gain Scheduling. It is the automatic transfer of control between one set of control values and another set in non-linear control systems. Up to six sets can be configured and each set is configured to operate over a selected input range where the control operates over a reduced and approximately linear range.

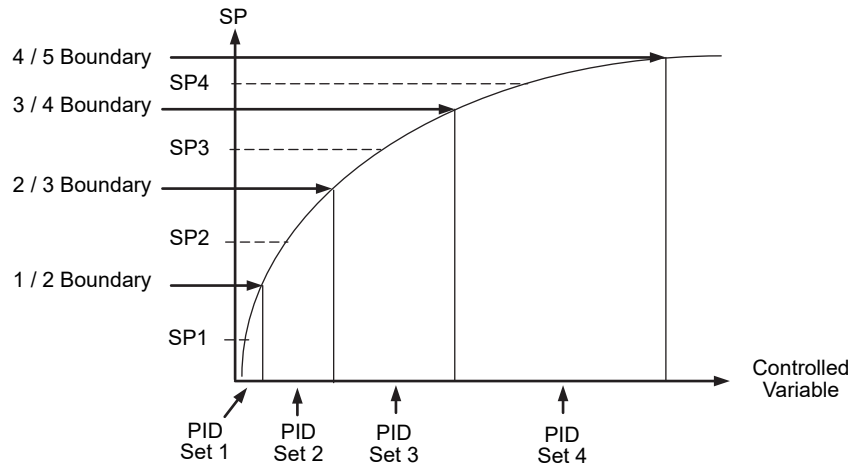

Figure 59 Gain Scheduling

Tuning Procedure

In normal operating mode 'Schedule type' will be set to PV, SP, OP, Error, Rem Sched IP or Soft Wired as dictated by the requirements of the process.

1. Select the number of PID sets required from 1 to 6.
2. Set the Boundaries over which each PID set is required to operate
3. Go to Configuration level (if not already selected)
4. Set 'Schedule Type' (*LPx SETUP/PID* page) = 'Set'
5. Go to Level 3
6. Select 'Active PID Set' = 'PID Set 1'
7. Set the Setpoint to control at a point approximately midway between 0 and 1/2 Boundary
8. Select Autotune as described in section To Autotune Control Loop Lp1. At the end of tune the values will be automatically stored into PID Set 1. It is possible to limit the output power in each set.
9. Repeat the above for all PID sets. For each set, adjust the SP approximately midway between the two boundaries (Figure 59)
10. When all PID sets have been determined, go back to configuration level and re-set 'Schedule Type' to the type required for the process

Note: It is possible to tune each set when Gain Scheduling is selected, but this is not recommended since it is possible that, at the end of tune, the values could be stored into the incorrect PID set. This might occur, for example, if the system is highly oscillatory and the values for, say, PID set 2 are stored when the excursion is in PID set 1.

Cascade Tuning

Cascade control uses a combination of two PID controllers, where the output of one (the master) provides the setpoint for the second (the slave). Cascade control was described in more detail in section Cascade Control. Figure 60 shows a cascade controller applied to the control of a furnace load.

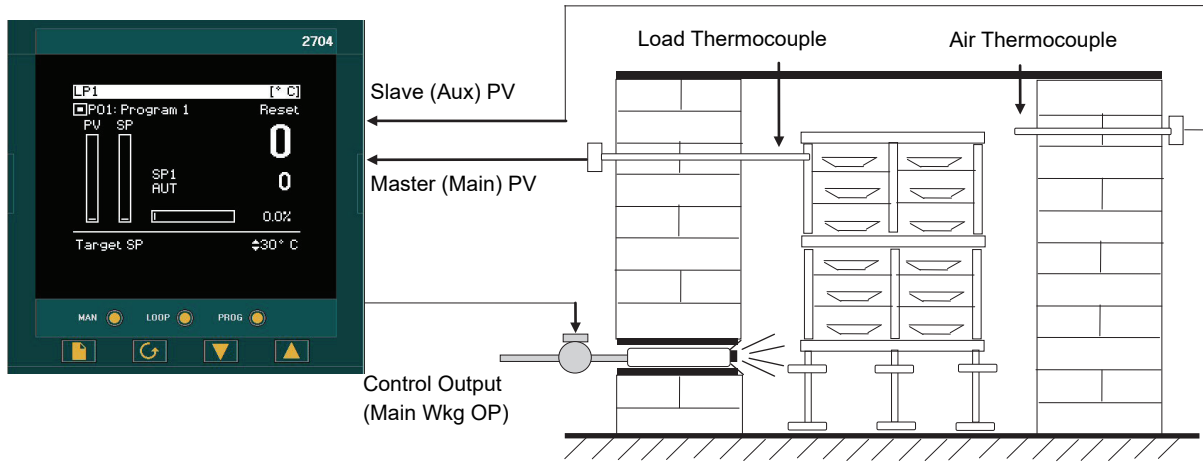

Figure 60 Cascade Control of a Furnace Load

When tuning a cascade loop it is necessary that both master and slave loops are tuned. It is recommended that each loop is tuned independently using the procedure below.

Because the slave loop is used by the master loop it must be tuned first.

To Tune a Full Scale Cascade Loop

Step 1. Configure the loop as cascade full scale as follows:

In LP1 SETUP/Options Page (section Loop Set Up (Options Page))	Set 'Loop Type' = Cascade
In LP1 SETUP/Cascade Page (section Cascade Parameters)	Set 'Cascade Mode' = Full Scale
	Set 'Disable CSD' = Yes
In LP1 SETUP/SP page (section Setpoint Parameters)	Set 'Setpoint 1' = the normal operating setpoint value for the main loop This connects the PV input from Module 3 to the slave PV of the cascade loop
In LP1 SETUP/SP(Aux) page (section LP1 Setup (SP Aux) Page)	Set 'Local SP' = the normal operating setpoint value for the slave loop (when cascade is disabled)

Step 2. Start the controller in Level 3 as follows:

In ACCESS Select Level 3

Step 3. Set tune output high and low limits as follows:

Note: For the slave tune you may wish to restrict the ability of the tuner to disturb the process. Tune OH should, therefore, be set to a value that will only enable the tune to achieve the local setpoint which is chosen.

In AUTOTUNE Set 'Tune OL' to a value which will limit the minimum output demand during tuning. This may be 0.0 for a heat only loop.

 Set 'Tune OH' to a value which will limit the maximum output demand during tuning.

Step 4. Start tune on the slave loop as follows:

In AUTOTUNE Set 'Autotune Loop' to LP1A

Step 5. You may monitor the progress of the tune by viewing the following parameters:

In AUTOTUNE	'Autotune State'	This indicates which step is being performed
	'Tune OP'	The output demand of the autotune. For a slave loop this will be the same as the working output power.
	'Tune SP'	The setpoint about which the loop is being tuned
	'Stage Time'	The length of time this particular step has been running. The tune step will abort after two hours

Step 6. On completion of the slave loop tuning:

Keep the loop in Cascade Disabled, and allow the slave loop to control the process. You must allow the slave loop to control at its Local SP. Wait for the master loop to settle to a steady state value. (Note, it is unlikely that the master loop steady state is the same as the slaves).

When the master PV is at a steady value proceed with tuning the master loop. (Note, if the master loop has not settled satisfactorily you may not be able to tune the master loop at all, since it is necessary to restrict the disturbance of the slave when tuning the master.

Step 7. Tune the master loop

In AUTOTUNE	<p>Set 'Tune OL' and 'Tune OH'</p> <p>The values chosen should be symmetrical and chosen such that the slave stays in control (typically ± 0.5 * slave proportional band).</p> <p>This amount, however, may not be sufficient to disturb the master to achieve a successful tune. If the proportional band of the master is in engineering units, the tune hysteresis of the master will be ± 1 engineering unit. For a temperature loop, therefore, the master must be disturbed by at least 1 degree.</p> <p>Tune OL and Tune OH are set in %. Although it is the master which is being tuned, it is the slave working SP which has to be modified in order to achieve a change in the output and hence measure a disturbance in the master PV. Therefore, Tune OL and Tune OH relate to a percentage of the slave range by which the slave working SP will be changed.</p> <p>For example, if the slave has a range of -200 to $+1372$ the slave range is 1572 and Tune OL and Tune OH are 1%, then the slave working setpoint will be modified by ± 15.72 degrees.</p>
In AUTOTUNE	Set 'Autotune Loop' to LP1
In LP1	Set 'Disable CSD to 'No'
SETUP/Cascade Page (11.10.7.)	This is to re-enable cascade mode and must be done before the time out period of 1 min

Step 8: Return to control

The slave and master loops should now be tuned. Try changing the main setpoint and observe the response. If the master PV response is oscillatory then you may not have restricted the disturbance of the slave enough. Try decreasing the values of 'Tune OL' and 'Tune OH' and retune the master.

To Tune a Trim Mode Cascade Loop

This example uses SP feedforward where the value of the MasterWSP is 50, the slave range is 0-200 and the Trim limits are 25%.

The slave setpoint calculation is shown in the diagram below which has been reproduced from the previous chapter.

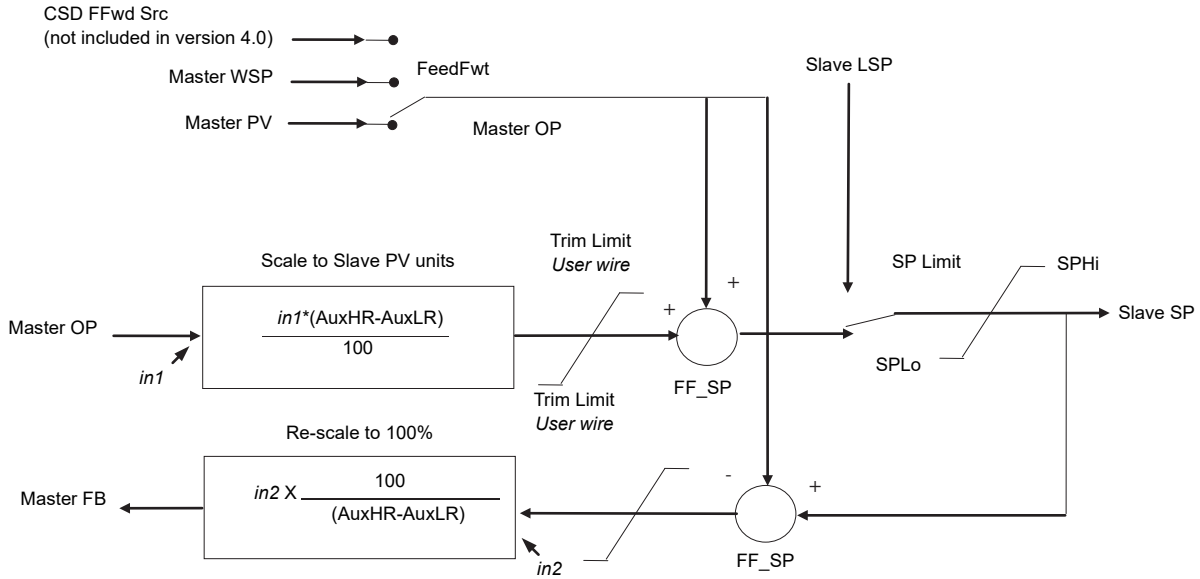

Figure 61 Cascade Controller in Trim Mode

The formula in the box "Scale to Slave PV units" simply normalises the masterOP to the slave range, for example, here a masterOP of 0% will produce a trim value of 0 units and an output of 100% a trim value of 200 units. A 50% master OP will produce 100. So if masterOP is 10% this will provide a trim value of 20 that will be added to the fed forward SP providing a working slave setpoint of 70.

It should also be noted if masterOP is 20% this should provide a trim value of 40, but because the trim limit is set a 25, instead of the slave setpoint going to 90 it will be limited to 75.

The feedback path via the parameter MasterFB ensures that the master loop will not go into integral saturation whilst the slave setpoint is being limited.

Tuning the Loop

Details of configuration

Master(LP1) loop range	= 0-100
Slave loop(LP1A) range	= 0-200
Cascade mode	= Trim SPFF(Setpoint feedforward)
CSDTrim lo	= -50(slave SP trim lo limit)
CSDTrim hi	= +50(slave SP trim hi limit)

Step 1. Tune slave

Disable cascade and tune the slave at a setpoint that you expect the slave to be operating at. In this case it is done at 70.

After tune is complete you must allow the slave to settle at its setpoint with no oscillations. This is very important.

Step 2 Tune Master

The master OP is normalised to the slave range. So in this configuration, if the master OP is 0%, the slave SP is also 0. If the master OP is 50% the SP is 100 and if the OP is 100% the setpoint is 200.

You need to inspect the value of the slave proportional band calculated by the slave autotune. In this case it was 36 (eng units).

To tune the master loop the autotune limits need to be set so that the slave SP is allowed to alter by half its proportional band. In this case, ± 18 units. To achieve this 'Tune OP low' is set to -9% and 'Tune OP high' to 9%. With a master SP of 70 this allows the slave to go to a high value of 88 and a low value of 52. Please note, during autotune the 9% is applied in addition to the Slave PV, not the slave setpoint when the master loop tune starts, therefore it is important that the slave has settled at its local SP.

After you have set the tune limits start the master(LP1) autotune and only after that enable cascade mode. When complete the controller can be operated in cascade mode.

Step 3 Normal Operation

Adjust the master SP to the required process value and observe control response.

Controller Applications

The 2704 controller contains control blocks specifically designed to suit a number of different applications.

Examples are:

Carbon Potential, Oxygen or Dew Point control using Zirconia probes

Humidity control using wet and dry platinum resistance thermometers

Vacuum Control

About this chapter

This chapter gives general descriptions (which are not intended to be of a particular installation) of the use of the 2704 controller in the above applications.

- Brief description and terminology applications using zirconia probes
- An example wiring diagram for carbon potential control
- Viewing and adjusting the parameters for a carbon potential controller
- An example of soft wiring for a carbon potential control loop
- Brief description of humidity control
- An example wiring diagram for humidity control
- Viewing and adjusting the parameters for a humidity controller
- An example of soft wiring for a humidity control loop
- Brief description of vacuum control
- An example wiring diagram for vacuum control
- Viewing and adjusting the parameters for a vacuum controller
- An example of soft wiring for vacuum control

Zirconia - Carbon Potential Control

A dual loop 2704 controller is required to control temperature of the process on one loop and carbon potential on the other. The controller is often a programmer which generates temperature and carbon potential profiles synchronised to a common timebase. In this section it is assumed that a programmer is used.

Temperature Control

The sensor input of the temperature loop may come from the zirconia probe but it is common for a separate thermocouple to be used. The controller provides a heating output which may be connected to gas burners or thyristors to control electrical heating elements. In some applications a cooling output may also be connected to a circulation fan or exhaust damper.

Carbon Potential Control

The zirconia probe generates a millivolt signal based on the ratio of oxygen concentrations on the reference side of the probe (outside the furnace) to the amount of oxygen in the furnace.

The controller uses the temperature and carbon potential signals to calculate the actual percentage of carbon in the furnace. This second loop generally has two outputs. One output is connected to a valve which controls the amount of an enrichment gas is supplied to the furnace. The second output controls the level of dilution air.

Sooting Alarm

In addition to other alarms which may be detected by the controller (see also Alarm Operation 'Alarm Configuration'), the 2704 can trigger an alarm when the atmospheric conditions are such that carbon will be deposited as soot on all surfaces inside the furnace.

Automatic Probe Cleaning

The 2704 has a probe clean and recovery strategy that can be programmed to occur between batches or manually requested. A short blast of compressed air is used to remove any soot and other particles that may have accumulated on the probe. Once the cleaning has been completed the time taken for the probe to recover is measured. If the recovery time is too long this indicates that the probe is ageing and replacement or refurbishment is due. During the cleaning and recovery cycle, the %C reading is frozen thereby ensuring continuous furnace operation.

Endothermic Gas Correction

A gas analyser may be used to determine the CO concentration of the endothermic gas. If a 4-20mA output is available from the analyser, it can be fed into the 2704 to automatically adjust the calculated % carbon reading. Alternatively, this value can be entered manually.

Example of Carbon Potential Controller Connections

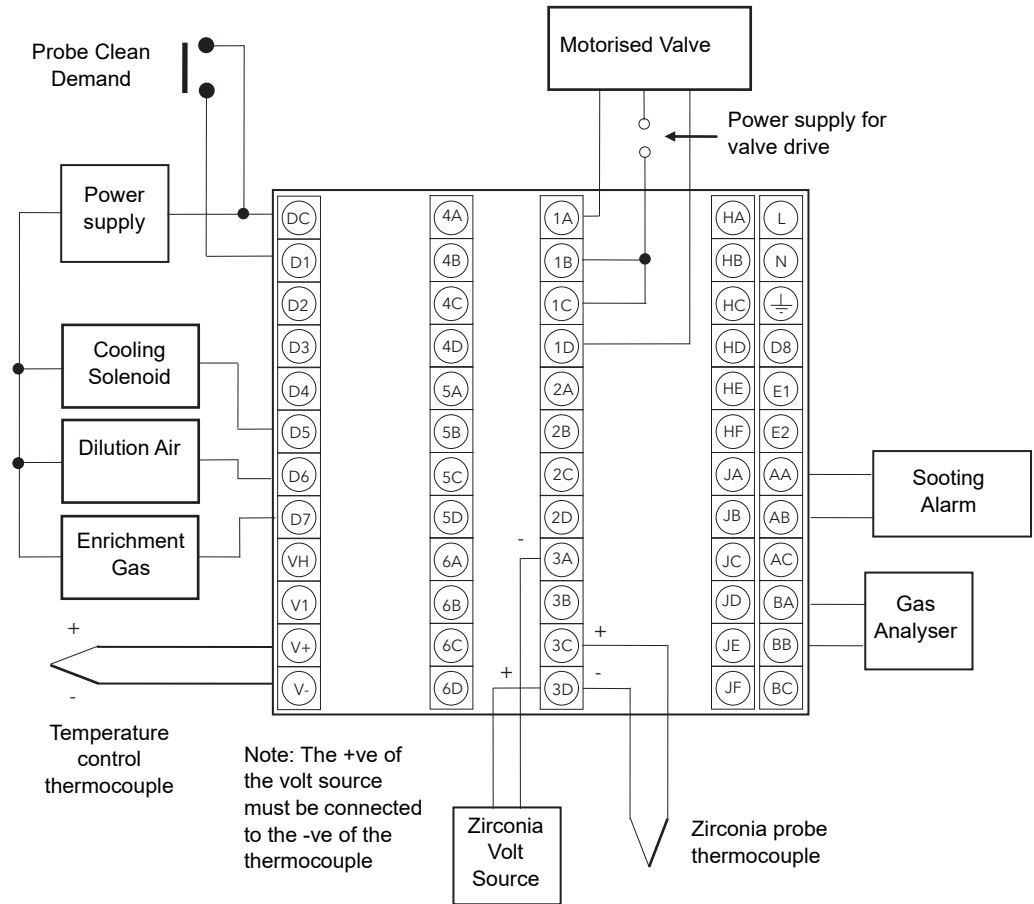



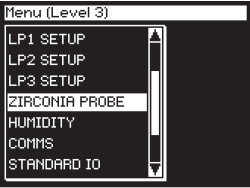

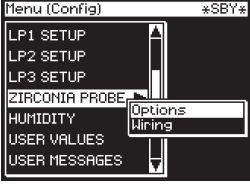



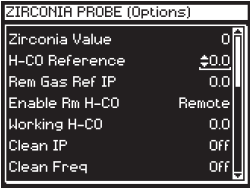



Figure 62 An Example of 2704 Wiring for Carbon Potential Control

The above diagram is a generalised connection diagram, for further information refer to Installation, and to the instructions supplied by the probe manufacturer. In the above example the following modules are fitted. This will change from installation to installation:

- | | |
|-------------------------|--|
| Module 1 | Dual triac or relay to drive motorised valve |
| Module 3 | Dual PV Input Module |
| Standard Digital I/O | Used as logic input for manual probe clean and outputs for solenoid valve drives |
| Standard PV Input | For the temperature control thermocouple input |
| Standard Analogue Input | For gas analyser |
| Standard Relay Output | For sooting alarm |

To View and Adjust Zirconia Parameters

Do This	This Is The Display You Should See	Additional Notes
1. From any display press  as many times as necessary to access the page header menu 2. Press  or  to select 'ZIRCONIA PROBE'		This page is only available if 'Zirconia' is Enabled in the INSTRUMENT (Options) page
3. Press  to display sub-headers		Options Configure and adjust zirconia parameters. Wiring Soft wires zirconia parameters
4. Press  or  to scroll to the required sub-header 5. Press  to select the parameter list for the required sub-header		

The full list of parameters available under these list headers is shown in the following tables 

Zirconia Parameters

Table 47: This table allows you to view or adjust zirconia probe parameters			ZIRCONIA PROBE (Options Page)	
Parameter Name	Parameter Description	Value	Default	Access Level
Zirconia Value	Zirconia control process value The O2 or dew point value derived from temperature and remote gas ref inputs	Range units		R/O
Probe Type	Zirconia probe equation	See note 1 for types supported		Conf
Units	Zirconia display units	See Appendix D.2.		Conf
Resolution	Zirconia display resolution	XXXXX to XX.XXX		Conf
Oxygen Exp (Note 2)	Oxygen units Only available for 'Probe Type' = 'Log Oxygen'	0 to 19		Conf
The following 10 parameters are not relevant to 'Probe Type' = 'Oxygen'				
H-CO Reference	Gas reference	0.0 to 999.0	20.0	L3
Rem Gas Ref IP	Remote gas reference	0.0 to 999.0		L3
Enable Rem H-CO	Remote gas enable. This can be an internal value from the user interface or remote from an external source.	Internal Remote	Internal	L3
Working H-CO	Working gas reference or process factor	0.0 to 999.0		L3 R/O

Table 47: This table allows you to view or adjust zirconia probe parameters		ZIRCONIA PROBE (Options Page)		
Parameter Name	Parameter Description	Value	Default	Access Level
Process Factor	Process Factor is used in some zirconia probes to provide compensation for the varying abilities of different alloys to absorb carbon. Applies to MMI probes only	0.0 to 999.0		L3
Clean Mode	Clean probe input	Off On	Off	L3
Clean Freq	Zirconia probe cleaning interval	Off to 99:54:00.0	4:00:00:0	L3
Clean Duration	Sets the cleaning time	0:00:06.0 to 1:39:54.0	0:10:00:0	L3
Max Recvy Time	Maximum recovery time after purging	0:00:06.0 to 1:39:54.0	0:10:00:0	L3
Min Recvy Time	Minimum recovery time after purging	0:00:06.0 to 1:39:54.0	0:10:00:0	L3
Min Cal Temp	Minimum calculation temp.	-999.0		L3
Probe Offset	Zirconia mV offset	to	0.0	L3
Temp Offset	Sets the temperature offset for the probe	2000.0	0.0	L3
The following 4 parameters are not relevant to 'Probe Type' = 'Oxygen'				
Next Clean	Time to next cleaning. (counts down to 0:00:00.0)	0:00:00.1		R/O L1
Clean State	The burn off state of the zirconia probe	Inactive Cleaning Recovering		R/O L1
Clean Output	Clean valve output	Off/On	Off	R/O L3
Probe Status	Probe requires cleaning	Good/Bad		R/O L1
Probe SBrk	Probe sensor break	No/Yes		R/O L1
The following parameter is not relevant to 'Probe Type' = 'Oxygen'				
Sooting Alarm	Probe sooting alarm output	Good/Bad		R/O L1
SootVal Scalar	Sooting value scalar	0.0 to 100.0	1.0	L3
Probe IP	Zirconia probe mV input	-0.100 to 2.000		R/O
Temp IP	Zirconia probe temp input val	Temp range		R/O L3
PV Invalid	PV Invalid	No/Yes		L3
This is a boolean which is true when the temperature is below that set by 'Min Cal Temp'. It may have been wired in configuration mode, for example, to disable the gas valve				
The following parameter is not relevant to 'Probe Type' = 'Oxygen'				
PV Frozen	PV Frozen	No/Yes		L3
This is a boolean which freezes the PV during a purging cycle. It may have been wired in configuration mode, for example, to disable control output during purging				

Note 1 Probe types supported: Probe mV, Bosch Carbon, Barber-Colman, MMI Carbon, MMI Dewpoint, AACC, Drayton, ACP, SSI, MacDhui, Oxygen, Log Oxygen, Bosch Oxygen, Dewpoint.

Note 2 To configure Oxygen in ppm, select 'Probe Type' = 'Oxygen' and 'Oxygen Exp' = '4'

Wiring Page

Table 48: These parameters configure zirconia probe block wiring.			ZIRCONIA PROBE (Wiring Page)	
Parameter Name	Parameter Description	Value	Default	Access Level
mV Src	Zirconia probe mV input source	Modbus address		Conf
Temp Src	Zirconia probe temperature input source	Modbus address		Conf
Clean Src	Zirconia clean probe input source Not available for Oxygen Probe Types	Modbus address		Conf
Rem Gas Src	Remote gas reference/Process factor source Not available for Oxygen Probe Types	Modbus address		Conf.

Zirconia Wiring Example

The Zirconia Function Block

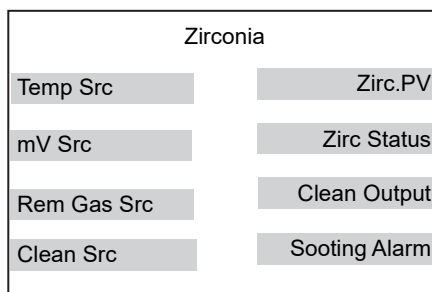

Figure 63 Zirconia Function Block

Main Features

Calculation of PV: The Process Variable can be carbon potential, Dewpoint or Oxygen concentration. The PV is derived from the probe temperature input, the probe mV input and remote gas reference input values. Various probe makes are supported.

Endothermic Gas Correction: This enables the user to set the percentage of carbon monoxide (%CO) present in the Endothermic Gas. This value can be measured via a gas analyser and fed into the controller as an analogue value.

Probe Clean: As these sensors are used in furnace environments they require regular cleaning. Cleaning (Burn Off) is performed by forcing compressed air through the probe. Cleaning can be initiated either manually or automatically using a timed period. During cleaning the PV output is frozen.

Health Alarm (Zirconia Probe Status): After cleaning an alarm output is generated if the PV does not return to 95% of its value within a specified time. This indicates that the probe is deteriorating and should be replaced.

Sooting Alarm: An output is generated which indicates that the furnace is about to soot.

Configuration of a Carbon Potential Control Loop

This example assumes that the probe temperature (Type K) input is connected to module 3 and the milli-volt input to module 6. Loop 1 normally controls temperature, so the carbon loop will be Loop 2. Carbon control and alarm outputs are relays and configured as On/Off.

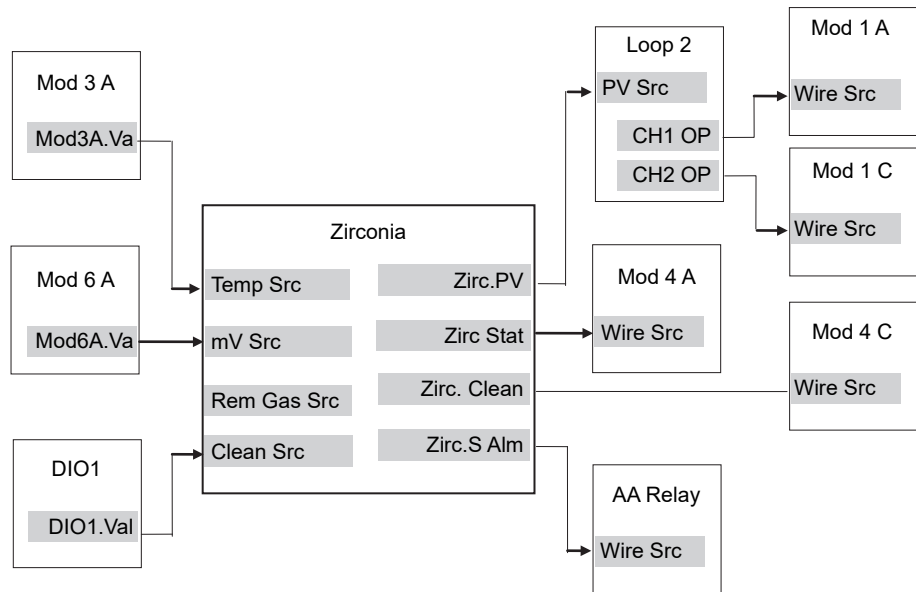

Figure 64 Zirconia Wiring for Carbon Potential

Implementation

1. In INSTRUMENT/Options Page (section Instrument Options Page),
 - set 'Num of Loops' = 2
 - set 'Zirconia' = Enabled

2. In MODULE IO/Module 3A Page (section PV Input)
 - set 'Channel Type' = Thermocouple
 - set 'Linearisation' = K-Type
 - set 'Units' = °C/°F/°K
 - set 'Resolution' = XXXXX
 - set 'SBrk Impedance' = Low
 - set 'SBrk Fallback' = Up Scale
 - set 'CJC Type' = Internal

This configures Module 3 to measure temperature.

3. In MODULE IO/Module 6A Page (section PV Input)
 - set 'Channel Type' = HZVolts
 - set 'Linearisation' = Linear
 - set 'Units' = mV
 - set 'Resolution' = XXXXX
 - set 'SBrk Impedance' = Off
 - set 'SBrk Fallback' = Up Scale
 - set 'Electrical Lo' = 0.00
 - set 'Electrical Hi' = 2.00
 - set 'Eng Val Lo' = 0.00
 - set 'Eng Val Hi' = 2000

This configures Module 6 to measure probe mV.

- | | |
|---|---|
| <p>4. In STANDARD IO/Dig IO1 Page
(section Standard IO Diagnostic Parameters Table)</p> | <p>set 'Channel Type' = Digital Input
This configures DIO1 to be a digital input.</p> |
| <p>5. In ZIRCONIA PROBE/Options Page
(section Zirconia Parameters)</p> | <p>set 'Probe Type' = <i>Type of probe in use</i>
set 'Units' = %CP
set 'Resolution' = XXX.XX
set 'H-CO Reference' = <i>Required Value</i>
<i>This value defines the % carbon monoxide (%CO) in the gas used for carburising</i>
This configures the zirconia probe</p> |
| <p>6. In ZIRCONIA PROBE/Wiring Page
(section Wiring Page)</p> | <p>set 'Clean Src' = 05402:DI01.Val
set 'mV Src' = 04948:Mod6A
set 'Temp Src' = 04468:Mod3A
This connects inputs to the Zirconia block</p> |
| <p>7. In LP2 SETUP/Options Page (section Loop Set Up (Options Page))</p> | <p>set 'Loop Type' = Single
set 'Control Type' = OnOff→Ch1&2</p> |
| <p>8. In LP2 SETUP/Wiring Page (section Loop Set Up (Wiring Page) Single Loop)</p> | <p>set 'PV Src' = 11059:Zirc.PV
This connects the PV to Loop 2 PV</p> |
| <p>9. In MODULE IO/Module 1A Page
(section Relay Output)</p> | <p>set 'Channel Type' = On/Off
set 'Wire Src' = 01037:L2.Ch1OP
This connects LP2 Ch1 output to module 1</p> |
| <p>10. In MODULE IO/Module 1C Page
(section Relay Output)</p> | <p>set 'Channel Type' = On/Off
set 'Wire Src' = 01038:L2.Ch2OP
This connects LP2 Ch2 output to module 1</p> |
| <p>11. In MODULE IO/Module 4A Page
(section Relay Output)</p> | <p>set 'Channel Type' = On/Off
set 'Wire Src' = 11066:Zirc.Stat
This connects the health (probe status) to module 4A</p> |
| <p>12. In MODULE IO/Module 4C Page
(section Relay Output)</p> | <p>set 'Channel Type' = On/Off
set 'Wire Src' = 11067: Zirc.Clean
This connects the clean outputs to module 4C</p> |
| <p>13. In STANDARD IO/AA Relay Page
(section Standard IO AA Relay Parameters)</p> | <p>set 'Channel Type' = On/Off
set 'Wire Src' = 11068: Zirc.SAlm
This connects the sooting alarm to the fixed relay output</p> |

See Appendix D for list of Modbus addresses.

☺ Tip:- See 'Copy and Paste' description in Soft Wiring.

Probe Impedance

Probe impedance can be read by the parameter 'SBrk Trip Imp'. This parameter is found in the Standard IO or Module IO, PV or Analogue Inputs. It is, however, normal to use the Dual PV Input module for use with a Zirconia probe, so the 'SBrk Trip Imp' parameter will be found in MODULE IO/Module 3 or 6 page.

The units for this parameter is % and depends upon the setting of the 'SBrk ImpRamp Rate Programmer

If 'SBrk Impedance' = 'Low' then a 'SBrk Trip Impedance reading of 100% is approximately 100K Ω

If 'SBrk Impedance' = 'High' set 'Channel Type' = On/Off
then a 'SBrk Trip Impedance reading of 100% is approximately 500K Ω

For a Zirconia probe the normal setting for 'SBrk Impedance' = 'High'

Humidity Control

Overview

Humidity (and altitude) control is a standard feature of the 2704 controller. In these applications the controller may be configured to generate a setpoint profile (see Programmer Configuration).

Also the controller may be configured to measure humidity using either the traditional Wet/Dry bulb method (Figure 65) or it may be interfaced to a solid state sensor.

The controller output may be configured to turn a refrigeration compressor on and off, operate a bypass valve, and possibly operate two stages of heating and/or cooling

Example Of Humidity Controller Connections

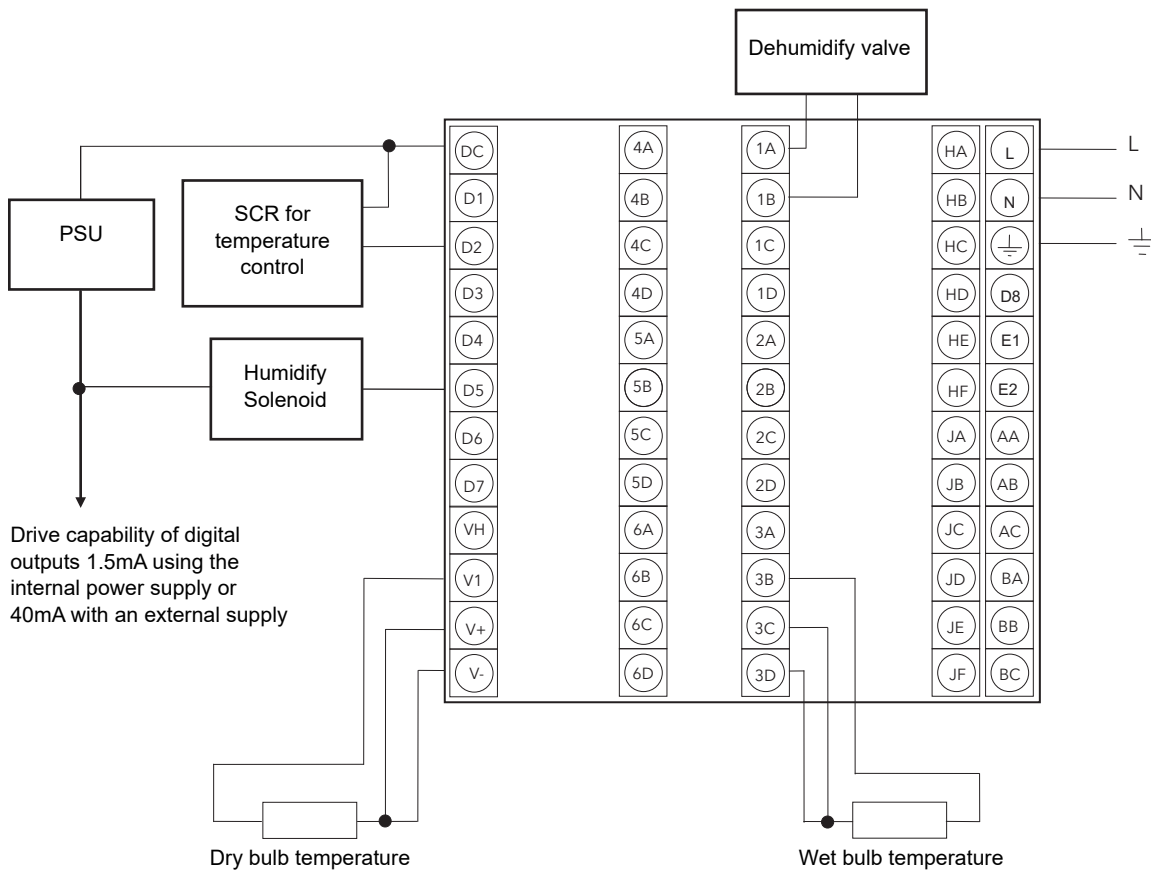

Figure 65 Example of Humidity Controller Connections

In the above example the following modules are fitted. This will change from installation to installation:

Module 1	Analogue or relay to drive dehumidify valve
Module 3	PV input module for wet bulb temperature RTD
Standard Digital I/O	Used as logic outputs for humidify solenoid valve and temperature control SCR
Standard PV Input	For the dry bulb RTD used for the temperature control and humidity calculation

Temperature Control of an Environmental Chamber

The temperature of an environmental chamber is controlled as a single loop with two control outputs. The heating output time proportions electric heaters, usually via a solid state relay. The cooling output operates a refrigerant valve which introduces cooling into the chamber. The controller automatically calculates when heating or cooling is required.

Humidity Control of an Environmental Chamber

Humidity in a chamber is controlled by adding or removing water vapour. Like the temperature control loop two control outputs are required, i.e. Humidify and Dehumidify.

To humidify the chamber water vapour may be added by a boiler, an evaporating pan or by direct injection of atomised water.









If a boiler is being used adding steam increases the humidity level. The humidify output from the controller regulates the amount of steam from the boiler that is allowed into the chamber.

An evaporating pan is a pan of water warmed by a heater. The humidify output from the controller humidity regulates the temperature of the water.

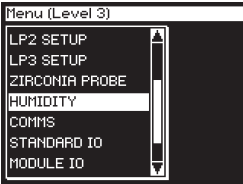
An atomisation system uses compressed air to spray water vapour directly into the chamber. The humidify output of the controller turns on or off a solenoid valve.

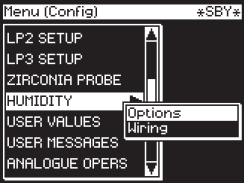
Dehumidification may be accomplished by using the same compressor used for cooling the chamber. The dehumidify output from the controller may control a separate control valve connected to a set of heat exchanger coils.

To View and Adjust Humidity Parameters

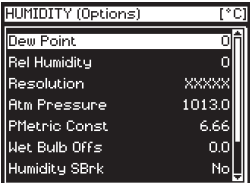
Do This	This Is The Display You Should See	Additional Notes
1. From any display press  as many times as necessary to access the page header menu 2. Press  or  to select 'HUMIDITY'		This page is only available if 'Humidity' is Enabled in the INSTRUMENT (Options) page
3. Press  to display sub-headers		Options Configure and adjust zirconia parameters. Wiring Soft wires zirconia parameters
4. Press  or  to scroll to the required sub-header 5. Press  to select the parameter list for the required sub-header		

The full list of parameters available under these list headers is shown in the following tables 

Humidity Options Parameters

Table 49: These parameters allow you to view or adjust the parameters for humidity control		HUMIDITY		
Parameter Name	Parameter Description	Value	Default	Access Level
Dew Point	Wet/Dry temperature measurement of dew point	-999.9 to 999.9		L1 R/O
Rel Humidity	Relative Humidity	0.0 to 100.0		L1 R/O
Resolution	Display resolution	XXXXX XXXX.X XXX.XX XX.XXX X.XXXX		L3
Atm Pressure	Atmospheric Pressure	0.0 to 2000.0	1013 mbar	L3
PMetric Const	Psychrometric Constant	0.0 to 10.0	6.66	L3
Wet Bulb Offs	Wet bulb temperature correction	-100.0 to 100.0	0.0	L3
Humidity SBrk	Sensor break action for humidity control	No Yes		L1 R/O
Dry Bulb Temp	Dry Bulb Temperature	Range units		L1 R/O
Wet Bulb Temp	Wet Bulb Temperature	Range units		L1 R/O

Wiring Page

Table 50: These parameters configure humidity block wiring.		HUMIDITY (Wiring Page)		
Parameter Name	Parameter Description	Value	Default	Access Level
Dry Bulb Src	Dry bulb temperature source	Modbus address.		Conf
Wet Bulb Src	Wet bulb temperature source			Conf
Atm Press Src	Atmospheric pressure source			Conf
PMtric Cst Src	Psychrometric Constant source		6.66	Conf

Humidity Wiring Example

The Humidity Function Block

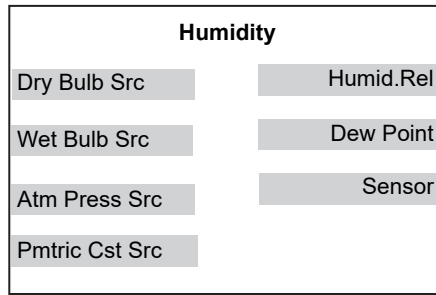

Figure 66 Humidity Function Block

Main Features

Calculation of PV: The Process Variable can be Relative Humidity or Dewpoint. The PV is derived from the wet and dry bulb inputs and atmospheric pressure.

Pressure Compensation: This value can be measured via a transmitter and fed into the controller as an analogue value. Alternatively, it can be set as a fixed parameter.

Configuration of a Humidity Control Loop

This example assumes that the dry temperature (Pt100) input is connected to the main PV and the wet input (Pt100) to module 3. Loop 1 normally controls temperature, so the humidity loop will be Loop 2. Humidity control outputs are relays and configured as time proportioning.

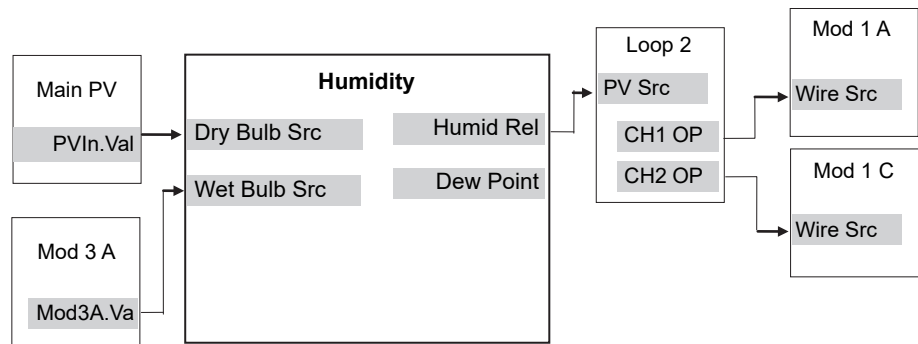

Figure 67 Humidity Control Loop

Implementation

1. In INSTRUMENT/Options Page (section Instrument Options Page), set 'Num of Loops' = 2
set 'Humidity' = Enabled
2. In STANDARD IO/PV Input Page (section PV Input) set 'Channel Type' = RTD
set 'Linearisation' = PT100
set 'Units' = °C/°F/°K
set 'Resolution' = XXXX.X
set 'SBrk Impedance' = Low
set 'SBrk Fallback' = Up Scale
This configures the PV Input to measure dry temperature
3. In MODULE IO/Module 3A Page (section PV Input) set 'Channel Type' = RTD
set 'Linearisation' = PT100
set 'Units' = °C/°F/°K
set 'Resolution' = XXXX.X
set 'SBrk Impedance' = Off
set 'SBrk Fallback' = Up Scale
This configures Module 3 to measure wet temperature
4. In HUMIDITY/Options Page (section Humidity Options Parameters) set 'Atm Pressure' = 1013.0 (for sea level)
5. In HUMIDITY/Wiring Page (section Wiring Page) set 'Dry Bulb Src = 05108:PVIn.Val
set 'Wet Bulb Src = 04468:Mod3A.Val
This connects the sensors to the humidity block
6. In LP2 SETUP/Options Page (section Loop Set Up (Options Page)) set 'Control Type' = PID→Ch1 PID→Ch2
7. In LP2 SETUP/Wiring Page (section Loop Set Up (Wiring Page) Single Loop) Loop Set Up (Options Page) set 'PV Src' = 11105:Humid.Rel
Note: For Dewpoint select 11106
This connects the %RH output to Loop 2 PV
8. In LP2 SETUP/Output Page (section Table of Output Parameters) set 'OP Low Limit' = -100.0
set 'OP High Limit' = 100.0
9. In MODULE IO/Module 1A Page (section Relay Output) set 'Channel Type' = Time Proportion
set 'Wire Src' = 01037:L2.Ch1OP
This connects LP2Ch1 output to Module 1A
10. In MODULE IO/Module 1C Page (section Relay Output) set 'Channel Type' = Time Proportion
set 'Wire Src' = 01038:L2.Ch2OP
This connects L21Ch2 output to Module 1C

See Appendix D for list of Modbus addresses.

☺ Tip:- See 'Copy and Paste' description in Soft Wiring.

Vacuum Controller

The 2704 Vacuum Controller is designed for a variety of applications including:

- Melting/Casting furnaces
- Annealing/Sintering furnaces
- Brazing/CVD furnaces
- Freeze Dryers
- Diffusion/MBE furnaces
- Autoclaves

It can be used for vacuum control only and can be supplied for use with one vacuum gauge or three gauges. Alternatively, the vacuum block can be used together with another control loop, such as temperature control, in the same unit.

Analogue and digital IO is achieved using the fixed IO and plug in modules described in the above handbooks.

Note:

- For measurement of temperature use the standard PV Input (terminals V- to VH) or the PV Input module (part no. HA026359)
- For measurement of vacuum use the standard PV Input, the PV Input module or the Analogue Input module (part no. HA026686).
- Additional analogue and digital IO can be achieved with further plug in modules or the IO Expander unit.

Vacuum Chamber Example

Figure 68 shows a diagrammatic representation of a vacuum furnace or freeze drier using a diffusion and roughing pump to achieve the required vacuum levels. The roughing pump is used to achieve the first level of vacuum in the region of 10^{-2} mBar. At this point the diffusion pump is switched on to remove the atmosphere down to a 10^{-5} mBar region. Valves, used in conjunction with the pumps, are also switched by the 2704 vacuum controller. When the vacuum reaches the required level it is possible to start a temperature profile.

There are other variations to this system, for example, a cryogenic pump may be used in place of the diffusion pump with appropriate changes to pipe and valve layout.

The 2704 vacuum controller allows for the use of up to three measurement gauges. Typically these are low vacuum gauges such as the Pirani, or higher vacuum gauges such as the Penning or Inverted Magnetron. It is generally required to turn the power off to the higher vacuum level gauge when the vacuum is below its working range.

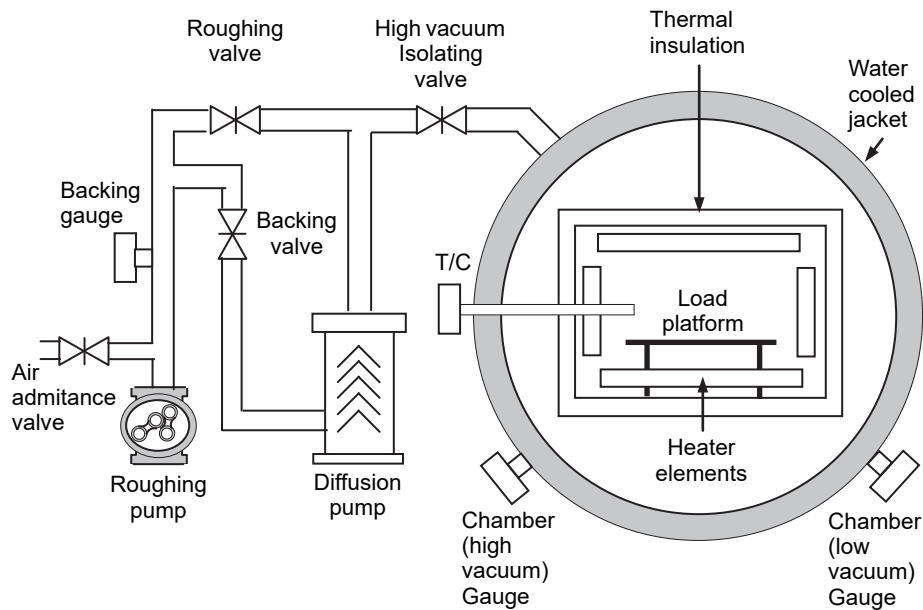

Figure 68 Representation of a Vacuum Chamber

Vacuum Controller Functionality

The 2704 vacuum controller provides on/off outputs to the vacuum system, but, used in conjunction with the existing PID loops, provides the ability to control the temperature within the chamber or furnace. It provides the following features

1. Vacuum probe switchover
2. High vacuum gauge power up when required vacuum level is achieved
3. Backing chamber pressure measurement and setpoint output
4. Gauge status inputs
5. Leak detection
6. Roughing pump timeout
7. Gauge calibration

Setpoints

Six setpoint outputs are provided. These can be used to turn on and off vacuum gauges or other external devices or to set up internal conditions such as temperature program wait signals. Each setpoint may be configured with an on and off value. The two values are used to provide switching hysteresis on the setpoint output.

For example:-

- | | |
|---|---|
| <ol style="list-style-type: none"> 1. If On SP < Off SP
 Output = True if Input < On SP
 Output = False if Input > Off SP | <ol style="list-style-type: none"> 2. If On SP > Off SP
 Output = True if Input > On SP
 Output = False if Input < Off SP |
|---|---|

Figure 69 shows the first case. The On SP is a lower vacuum than the Off SP or in other words the SP is On when the vacuum is larger than the On SP. Vacuum values are given for reference purposes only.

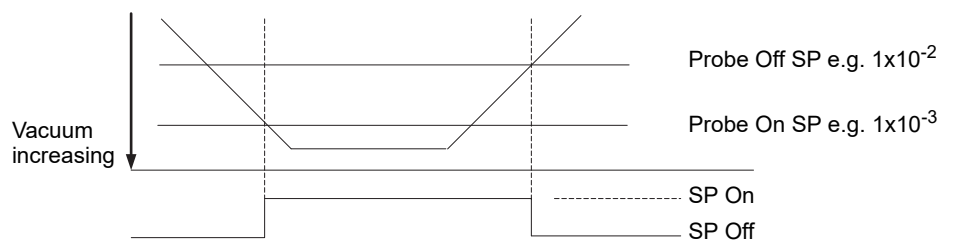

Figure 69 Setpoint Output Status when On SP < Off SP

Each setpoint is also provided with a user text string. This is displayed in the vacuum setpoint message box, shown in Figure 72. If more than one setpoint output is 'On' the message box cycles the messages.

Low Vacuum Gauge

The block will accept an input from a low vacuum gauge, typically used to measure vacuum in the range 10^1 to 10^{-4} mBar.

A probe status logic input is also provided. When the probe status is bad or the probe measurement is bad, the fault output from the block will be set and Sensor Break displayed.

High Vacuum Gauge

The block will accept an input from a low vacuum gauge, typically used to measure vacuum in the range 10^{-2} to 10^{-9} mBar.

A probe enable input is provided in the form of two setpoints and a logic output, and is operationally the same as the setpoint feature described in section Setpoints. When the probe status is bad or the probe measurement is bad, the fault output from the block will be set and 'Sensor Break' displayed.

Gauge Linearisation

This uses the linearisation ability of the analogue inputs described in Input Operators. Three linearisation curves are available which can be downloaded for each type of probe using iTools configuration software. The curve downloaded must correspond to the atmospheric gas being used. If further customised curves are required contact your supplier with details of the gauge characteristics.

Roughing Pump Timeout

When starting the chamber the roughing pump is run to get the chamber down to an initial level before the high vacuum pump is started. If a level of vacuum is not reached in a time (both of which are settable by the user) then the roughing pump timeout status is set.

The roughing pump timeout can be configured such that the vacuum measurement used for the timeout can be either the low vacuum gauge or the backing vacuum gauge.

When the roughing pump is started the **PUMP TOUT** (Figure 72) indicator flashes and continues to flash until the timeout is complete. If at the end of the timeout the required vacuum level is not reached the indicator stays permanently on.

Leak Detection

Vacuum chamber leaks are typically categorised into two areas, virtual leaks and real leaks. A virtual leak is a decrease in vacuum caused by outgassing of the workpiece and the chamber material/gaskets, etc. Therefore, in order for a leak to be detected, the reduction in vacuum must be monitored over a period of time with the pumps turned off. If there is a real leak the vacuum will continue to reduce, whereas if a virtual leak is present the vacuum will appear to decrease at a constant rate but then level off to give a steady vacuum reading.

The leak detection provides a measure of the rate of change of vacuum in vacuum-units/min. This is compared with an acceptable leak rate value after a timeout period. If the leak rate is not acceptable a leak fault will be indicated using the leak status parameter. When the measurement is being made, the **LEAK DET** (Figure 72) indicator on the summary screen flashes. It remains permanently lit if a fault is detected.

Gauge Switchover

Gauge switchover allows the chamber vacuum measurement to transfer from one gauge to another in a controlled (bumpless) way. The switchover block, described in Input Operators performs this. Figure 70 below gives an example of how the gauge outputs relate to the switch over settings. Vacuum values are given for reference purposes only.

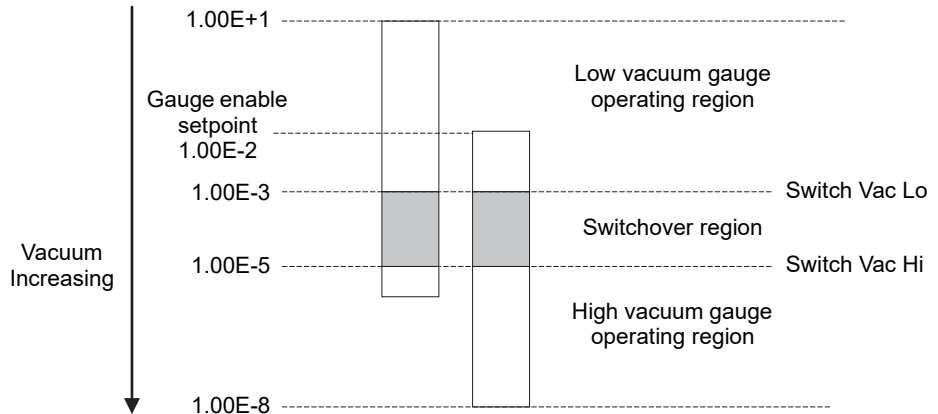

Figure 70 Gauge Switchover

The operating regions of each gauge must be chosen such that the gauge output is guaranteed. The switchover region should be selected such that both readings are valid and the error is minimal. The high gauge must be enabled before the lowest setting of the switchover point.

The gauge enable setpoint consists of a pair of gauge on and gauge off values. These should be chosen to give sufficient hysteresis such that the gauge output has a decisive on/off action. Both gauges read outside the switchover region even though the output has switched to the other gauge. This region of the gauge is usually very non-linear and typically has a high degree of error. This area of operation is only selected if the currently selected gauge goes into sensor break. The minimum vacuum and maximum vacuum values are defined as the total operating range of the two gauges and define the total range of the chamber.

Wiring Connections

The actual wiring of the vacuum controller depends upon the number and type of modules fitted. Figure 71 below shows wiring for the following configuration:-

- Fixed PV Input assigned as Thermocouple Input
- PV Input module fitted in slot 3 assigned as High Vacuum Input
- PV Input module fitted in slot 4 assigned as Backing Gauge Input
- PV Input module fitted in slot 6 assigned as Low Vacuum Input
- SP 1 turns on/off the roughing pump via fixed digital output 1
- The AA Relay turns on/off an external power supply to the high vacuum gauge
- Module 1 fitted as an analogue output to drive a thyristor unit for temperature control

Before proceeding further, please read Appendix B, Safety and EMC Information.

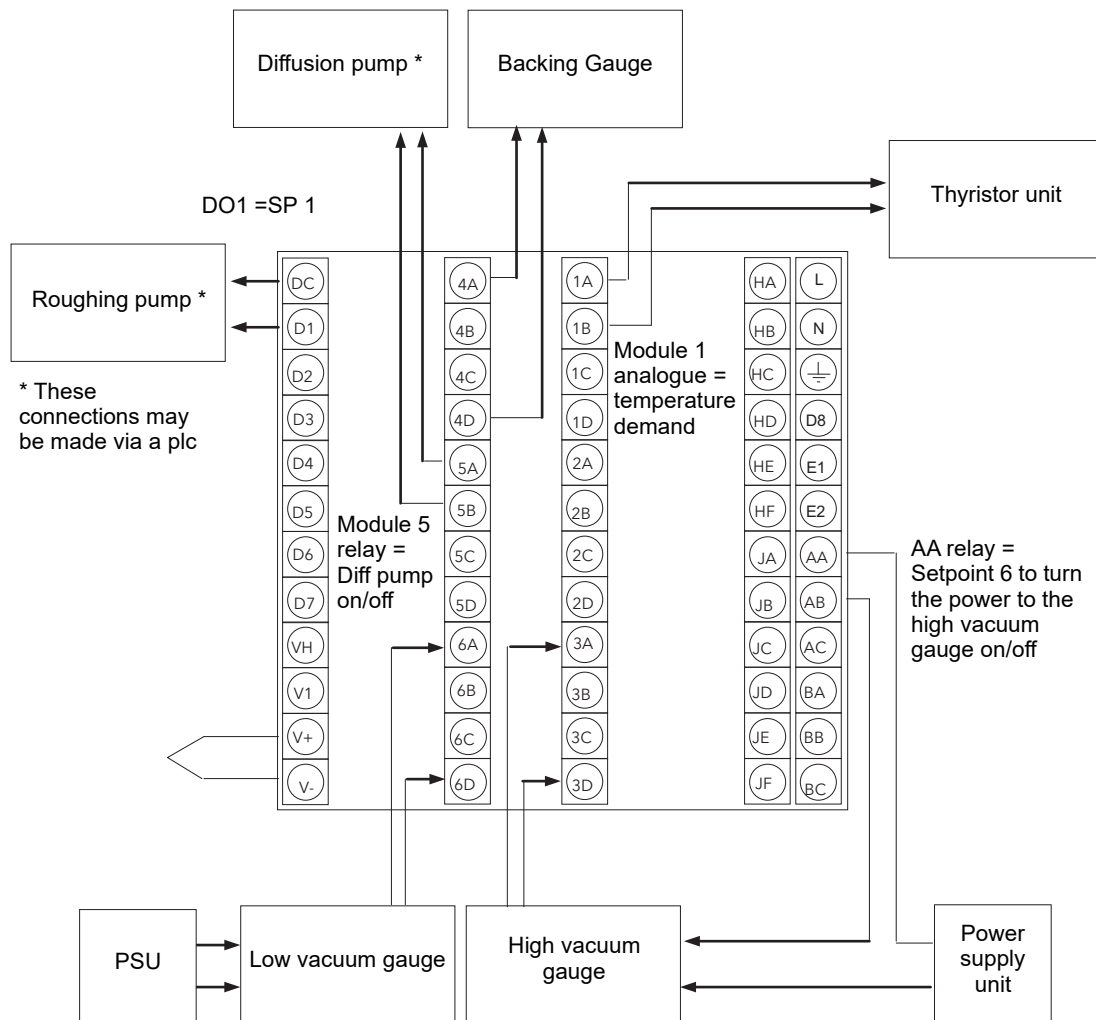
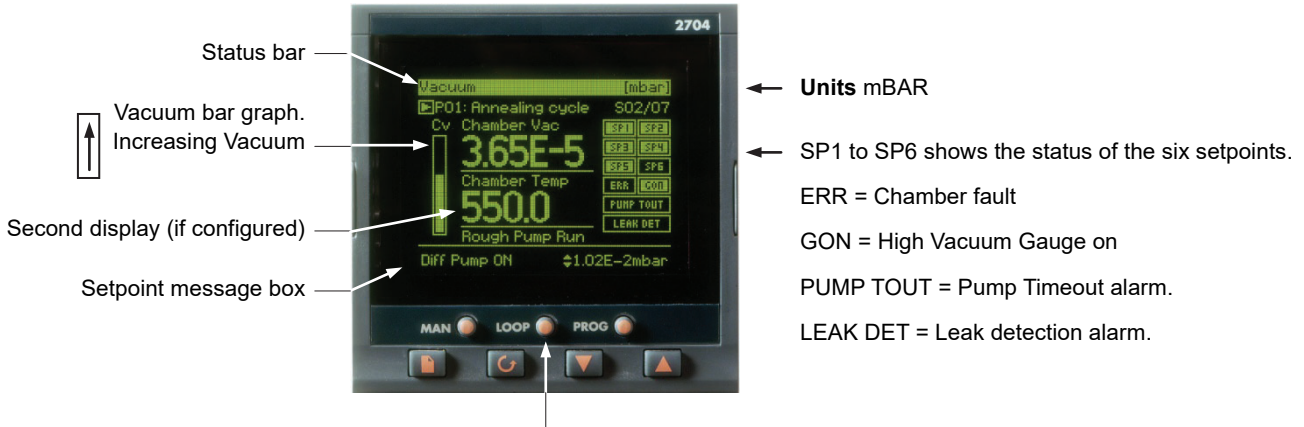

Figure 71 Example Wiring Connections

Switch On

Install and wire up the controller in accordance with the types of modules fitted and the configuration of the controller and switch on. A short self-test sequence takes place during which the controller identification is displayed together with the version number of the software fitted. For the vacuum controller the version number must be greater than 3.0.



The Loop Select button selects each loop display in turn or between each loop and the trend chart if the options are configured plus a summary of all loops

Figure 72 Operator View

This display is configurable by the user. The following may differ on your controller:-















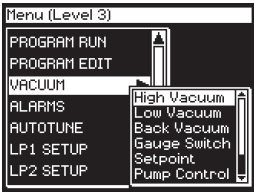

Chamber vacuum	Either switchover output or low vacuum outputs
Chamber text	Selected from a user text string
Second display	Only shown if a second function is configured, e.g. a temperature control loop.
Resolution	Decimal point may be selected as appropriate
Pump Timeout	Only shown if configured, (Vacuum Select ≠ None, section Pump Control Parameter Tables)
Leak Detect	Only shown if configured, (Vacuum Select ≠ None, section Pump Control Parameter Tables)

Operation

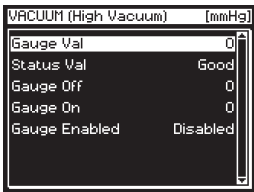
On a new instrument the vacuum controller can only be operated in access level 3. To enter access level 3 see Access Levels. However, it is possible to promote commonly used parameters to level 1. If this has been done the principle of operation in level 1 is the same as described below. To promote parameters, see section Instrument Page Promote Page.

To Access the Vacuum Controller Parameters

The vacuum controller parameters are grouped under page headings in exactly the same way as other parameters.

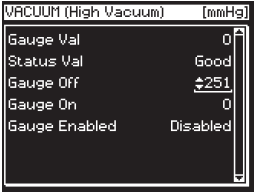
Do This	This Is The Display You Should See	Additional Notes
<ol style="list-style-type: none"> From any display press  as many times as necessary to access the page header menu Press  or  to select 'VACUUM' 		
<ol style="list-style-type: none"> Press  to display the list of sub-headers Press  or  to scroll through the list of sub-headings and to select the one required 		<p>The parameters are grouped by subject under the following sub-headings:-</p> <ul style="list-style-type: none"> High Vacuum gauge Low Vacuum gauge Backing Vacuum gauge Gauge Switch Setpoint Pump Control Leak Detect Display
<ol style="list-style-type: none"> Press  to display the parameter list Press  or  to scroll through the list of parameters associated with the chosen subject 		<p>These are listed in section Parameter Tables</p>
<ol style="list-style-type: none"> Press  or  to scroll to the required parameter Press  to underline the parameter Press  or  to change its value 	<p style="text-align: center;">To change the parameter value</p> 	

Parameter Tables

The following tables list all parameters, which are available in all levels (including configuration level).

They are accessed using the principle described in the previous section.

High Vacuum Parameter Tables

Table 51:		These parameters allow you to set up and configure the high vacuum gauge parameters. See also section High Vacuum Gauge.		<i>High Vacuum</i> or takes a user name
Parameter Name	Parameter Description	Value	Default	Access Level
Gauge Src	The source from which the high vacuum gauge is wired	Modbus address		Config
Gauge Val	The value read by the high vacuum gauge	Vacuum Display range		L3 R/O
Status Src	The source from which the gauge status is wired	Modbus address	None	Config
Status Val	The status condition	Good Bad		L3 R/O
Enable Select	The source from which the gauge enable is wired	Low Vac Backing Vac	Low Vac	Config
Gauge Off	The value at which the high vacuum gauge is switched off	Vacuum Display range		L3
Gauge On	The value at which the high vacuum gauge is switched on	Vacuum Display range		L3
Gauge Enabled	High vacuum gauge setpoint output	Enabled	Disabled	L3 R/O
Gauge Name	A user defined name for the high vacuum gauge	Disabled Usr 01 to 50	Default Text	Config

Low Vacuum Parameter Tables

Table 52:		These parameters allow you to set up and configure the low vacuum gauge parameters. See also section Low Vacuum Gauge		<i>Low Vacuum</i> or takes a user name
Parameter Name	Parameter Description	Value	Default	Access Level
Gauge Src	The source from which the low vacuum gauge is wired	Modbus address		Config
Gauge Val	The value read by the low vacuum gauge	Vacuum Display range		L3 R/O
Status Src	The source from which the gauge status is wired	Modbus address	None	Config
Status Val	The status condition	Good Bad		L3 R/O
Gauge Name	A user defined name for the low vacuum gauge	Usr 01 to 50	Default Text	L3

Backing Vacuum Parameter Tables

Table 53:		These parameters allow you to set up and configure the backing vacuum gauge parameters		Back Vacuum or takes a user name	
Parameter Name	Parameter Description	Value	Default	Access Level	
Gauge Src	The source from which the backing vacuum gauge is wired	Modbus address		Config	
Gauge Val	The value read by the backing vacuum gauge	Vacuum Display range		L3 R/O	
Status Src	The source from which the gauge status is wired	Modbus address	None	Config	
Status Val	The status condition	Good Bad		L3 R/O	
Gauge Name	A user defined name for the backing vacuum gauge	Usr 01 to 50	Default Text	L3	

Gauge Switching Parameter Tables

Table 54:		These parameters allow you to set up the conditions for transfer from one gauge to another. See also section Gauge Switchover.		Gauge Switch		
Parameter Name	Parameter Description	Value	Default	Access Level		
Active Gauge	Selected input	High Vac Low Vac Both		L3 R/O		
Min Vac	Display high	Vacuum Display range		L3		
Max Vac	Display low			L3		
Switch Vac Lo	High switch over		See Figure 70		L3	
Switch Vac Hi	Low switch over		See Figure 70		L3	
Enable Switch	Enable gauge switching	Off On	Off	L3		
Chamber Vac	Current chamber vacuum	Vacuum Display range		L3 R/O		
Op Status	Gauge status	Good Bad		L3 R/O		

Setpoint Parameter Tables

Table 55:		These parameters allow you to set up and configure the six setpoints. See also section Setpoints.		Setpoint	
Parameter Name	Parameter Description	Value	Default	Access Level	
Setpoint 1 Sel	Select the source of the vacuum value for SP1	None Low Vac High Vac Backing Vac Chamber Vac	None	L3	
Setpoint 1 Off	Value to turn off output	Vacuum Display range		L3	
Setpoint 1 On	Value to turn on output			L3	
Setpoint 1 Out	Current value of setpoint 1 output	Off On		L3 R/O	
Setpoint 1 Str	Name for setpoint 1	Usr 01 to 50	Default Text	Config	
The above parameters are repeated for setpoints 2 to 6					

Pump Control Parameter Tables

Table 56:		These parameters allow you to set up and configure the pump parameters such as timeout. See also section Roughing Pump Timeout.		Pump Control	
Parameter Name	Parameter Description	Value	Default	Access Level	
Vacuum Select	Select the source of the vacuum	None Low Vac High Vac Backing Vac Chamber Vac	None	L3	
Pump Running Src	Select the source to turn the pump on	Modbus address		Config	
Pump Running	To turn the pump on	No Yes	No	L3	
R Pump TimeOut	To set the timeout period	0:00:00.0	0:00:00.0	L1	
R Pump TimeRem	Time remaining	0:00:00.0		L1 R/O	
R Pump SP	To set the target vacuum for the timeout alarm	Vacuum Display range	0.000E+0	L1	
R Pump Status	Pump Timed Out	Good Bad		L3	

Leak Detect Parameter Tables

Table 57:		These parameters allow you to set up and configure the leak detection criterion. See also section Leak Detection.		Leak Detect	
Parameter Name	Parameter Description	Value	Default	Access Level	
Vacuum Select	Select the source of the vacuum	None Low Vac High Vac Backing Vac Chamber Vac	None	Config	
Vac Rate	Rate of change of vacuum	Vacuum	0.00E+0	L3 R/O	
Tgt Leak Rate	To set the target leak rate	Display range	0.00E+0	L3	
Turn Off Pump	Turn pump off during leak detection	Off On	Off	L3 R/O	
Leak Status	Leak detected	Off On		L3 R/O	
Leak Test Src	Leak test source	Modbus address		Config	
Leak T Start	Start leak test	No Yes	No	L3	
Leak T Time	To set the leak test time	0:00:00.0	0:00:00.0	L3	
Leak T Rem	Leak time remaining	0:00:00.0		L3 R/O	

Vacuum Display Parameter Tables

Table 58: These parameters allow you to set up the vacuum overview display. See also section Vacuum Controller.			Display	
Parameter Name	Parameter Description	Value	Default	Access Level
Show Sec Val	To configure the second display	Yes No		Config
Second Value	The current value of the above source	Display range		L3
Sec Val Src	To configure the source of the value shown on the second display	Modbus address		Config
Sec Val Name	To configure a user defined name for the second display	Usr 01 to 50	Default text	Config
Resolution	This configures the display resolution.	XXXXX XXXX.X XXX.XX XX.XXX X.XXXX SCI = 0.00E+0		Config
Units	To configure the vacuum units	mbar mmHg psi bar		Config
Chamber Status	Chamber fault as determined by ORing the status of each gauge	Good Bad		L3 R/O
<i>Chamber Vac</i>	Current chamber vacuum	Vacuum display range		L3 R/O
Graph Vac Lo	High point for graph scaling	Vacuum display range		L3
Graph Vac Hi	Low point for graph scaling	Vacuum display range		L3
Chamber Name	A user defined name for the chamber	Usr 01 to 50	Default text	Config













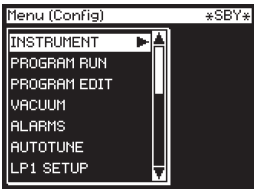

Note: Text shown in *italics* is the default which may be changed by the user.

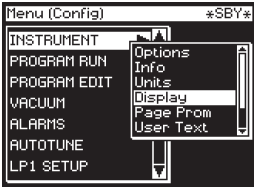
Configuration Level

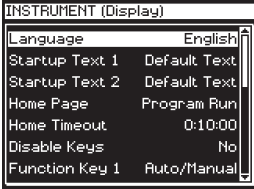
In configuration level you can choose the way in which you want the controller to operate, the format of the operator display, the name of the chamber in use and the names of the gauges. The parameters available have already been listed in the preceding tables. This section includes some examples of the configuration of a vacuum controller.





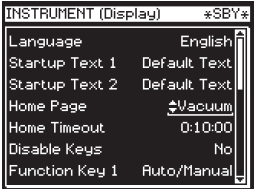





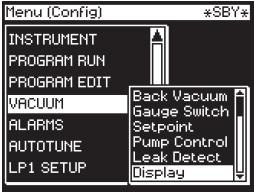

To Configure the Vacuum Summary as the HOME Page

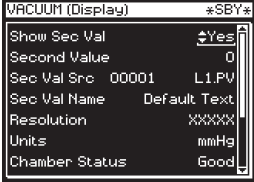
The vacuum summary display, shown in Figure 72, can be configured to be the start up page when the controller is powered up or when entering a new access level from configuration level.

Do This	This Is The Display You Should See	Additional Notes
1. From any display press  as many times as necessary to access the page header menu. 2. Press  or  to select 'INSTRUMENT'		
3. Press  to select sub-headers 4. Press  or  to scroll to 'Display'		Note: The vacuum block can be Enabled or Disabled in the INSTRUMENT/Options menu. If it is disabled none of the vacuum parameters are shown.
5. Press  to enter the 'INSTRUMENT/Display' parameter list		
6. Press  or  to scroll to 'Home Page' 7. Press  to underline the parameter 8. Press  or  to select 'Vacuum'		

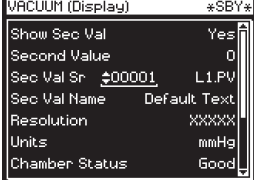
To Customise the Vacuum Summary Page

The vacuum summary page can be customised using the parameters listed in section Vacuum Display Parameter Tables.

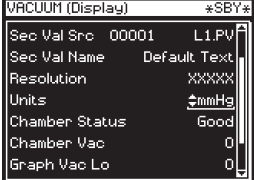
Do This	This Is The Display You Should See	Additional Notes
1. Select the VACUUM/Display page		
2. Press  to enter the parameter list 3. Press  to select 'Show Sec Val' 4. Press  or  to choose 'Yes' or 'No'	<p style="text-align: center;">To Select the Second Display</p> 	If 'Yes' is selected the operator view will show the second display, as shown in Figure 72.
5. Press  to display 'Sec Val Src' 6. Press  or  to choose the source of the second value	<p style="text-align: center;">To Select the Source of Second Display</p> 	The value which will be displayed on the vacuum summary display is sourced from the PV Input. In the examples given in this supplement this is chamber temperature.
7. Press  or  to scroll to 'Units' 8. Press  or  to select the units which will be displayed in the Status bar	<p style="text-align: center;">To Select Vacuum Units</p> 	Units which can be selected are: mmHg, psi, bar, mbar,

Other parameters which can be customised in the summary display include:

- A Name for the Second Display, chosen from User Text
- Resolution of the values displayed
- A Name for the Chamber, chosen from User Text

Vacuum Function Block

A description of function blocks is given in Function Blocks. The function block for the vacuum controller is shown in Figure 73 below and allows the user to soft wire to other devices within the controller to produce an individual control strategy.

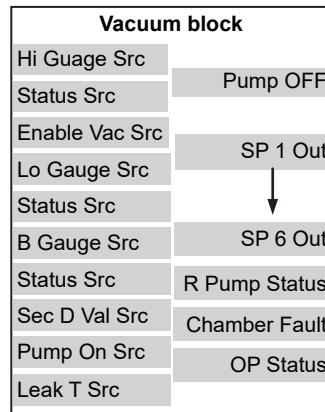

Figure 73 Vacuum Function Block

Vacuum Controller Wiring Examples

The vacuum function block may be internally wired in software to control specific applications. Soft Wiring is described in Soft Wiring.

Simple Temperature and Vacuum Control

The following example is included to show the principle of wiring between function blocks. It is not necessarily intended to be a complete solution to an application.

The vacuum function block has inputs from three vacuum gauges. A number of outputs are available as listed in the parameter tables. The example shows wiring from three of the setpoint outputs and a digital output used to turn the pump off. This example corresponds to the physical wiring diagram, Figure 71. The principle of wiring to other outputs is the same. A PID control block is used for temperature control receiving its setpoint from a programmer function block. The output from the PID block typically drives an analogue output to a thyristor unit. Further examples of PID block wiring are given in Loop Set Up.

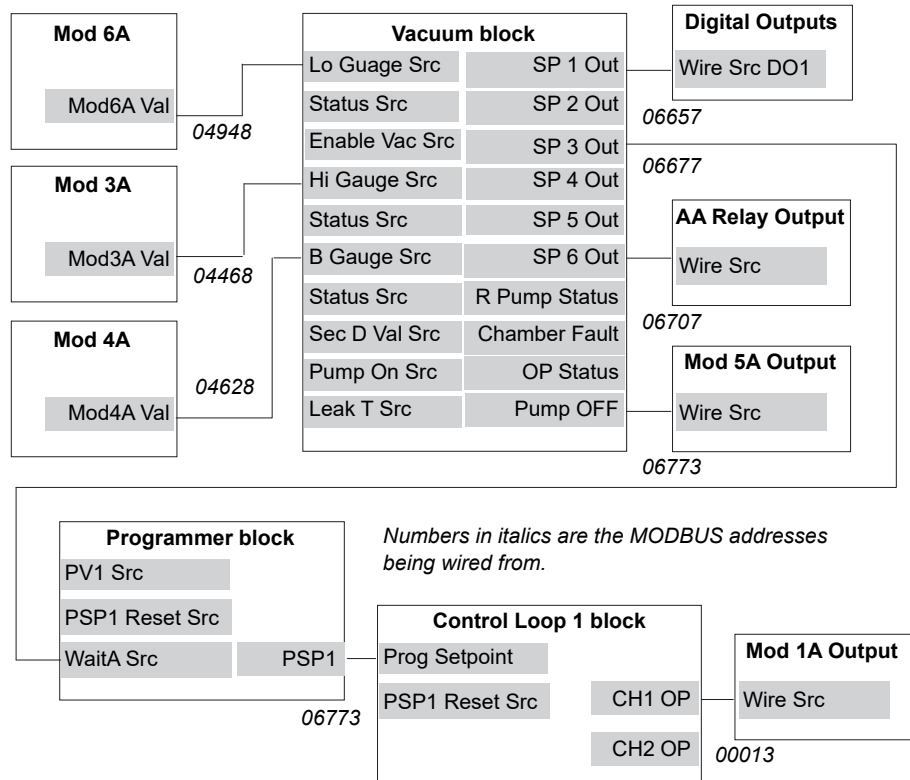

Figure 74 Vacuum/Temperature Control Wiring Example

Implementation

1. In VACUUM/Low Vacuum Page (section Low Vacuum Parameter Tables) set 'Gauge Src' = 04948: Mod6A.Val
This connects the low vacuum gauge, connected to module 3 input, to low vacuum gauge source
2. In VACUUM/High Vacuum Page (section High Vacuum Parameter Tables) set 'Gauge Src' = 04468: Mod3A.Val
This connects the high vacuum gauge, connected to module 6 input, to high vacuum gauge source
3. In VACUUM/Back Vacuum Page (section Backing Vacuum Parameter Tables) set 'Gauge Src' = 04628: Mod4A.Val
This connects the backing vacuum gauge, connected to module 4 input, to high vacuum gauge source
4. In STANDARD IO/Dig IO) 1 Page (section Standard Digital IO Parameters) set 'Channel Type' = On/Off
set 'Wire Src' = 06657
This configures Dig IO1 as a digital output and connects it to setpoint 1 output
5. In STANDARD IO/AA Relay Page (section Standard IO AA Relay Parameters) set 'Channel Type' = On/Off
set 'Wire Src' = 06707
This configures the AA relay as an on/off output and connects it to setpoint 6 output
6. In MODULE IO/Module 5A Page (section Relay Output) set 'Channel Type' = On/Off
set 'Wire Src' = 06773
This configures module 5 relay as an on/off output and connects it to the pump off output
7. In LP1 SETUP/Options Page (section Loop Set Up (Options Page)) set 'Prog Setpoint' = PSP1
set 'Wire Src' = 06773
Connects PSP1 to become the program setpoint for loop 1
8. In MODULE IO/Module 1A Page (section DC Control and DC Retransmission) set 'Channel Type' = Volts (or mA)
set 'Wire Src' = 00013:L1.Ch1.OP
This configures module 1 analogue output to volts (or mA) output and connects it to the Loop 1 PID output
9. In PROGRAM EDIT/Wiring Page (section PROGRAM EDIT Wiring Page) Set 'WaitA Src' = 06677
This connects Setpoint 3 output to the Wait A input of the programmer block

To Scale Vacuum Readout in Other Units

The vacuum units in the software version covered by this supplement are mbar only. To scale to alternative units use 'Analogue Operators' described Analogue And Multiple Operators.

In a two gauge system it is necessary to scale both gauges independently. In a single gauge system the low vacuum gauge is taken as the reference.

The following example shows a two gauge system, as wired in the previous section. The units conversion will be from mbar to mmHg, where 1mmHg = 1.333mbar

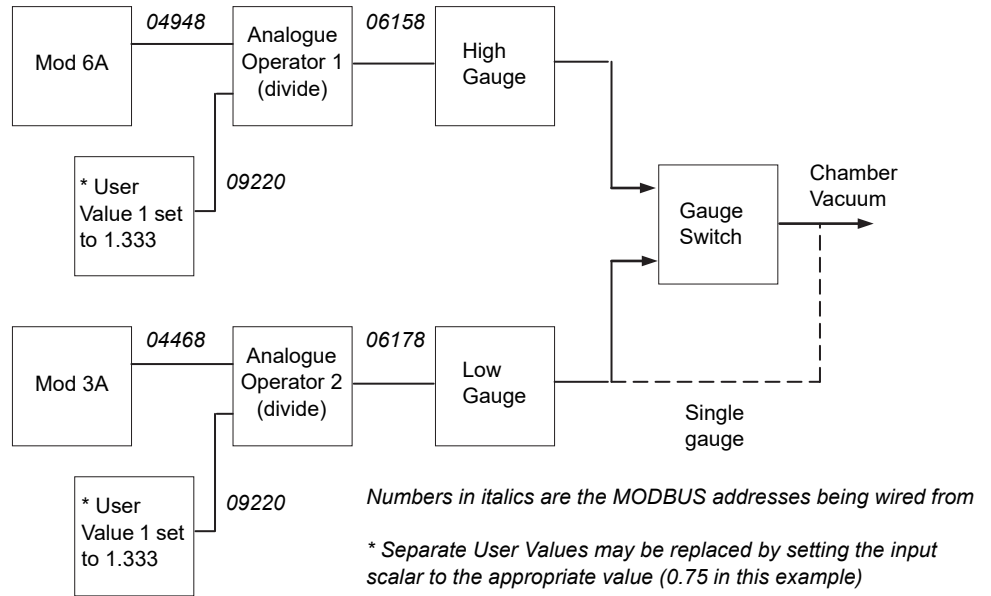

Figure 75 Scaling units in a two gauge system

Implementation

1. In USER VALUES/User Val 1* Page (section User Values Parameter Table)
 - set 'Resolution' = X.XXXX
 - set 'User 1 Value' = 1.333
 - (It may also be necessary to set the High Limit to > 1.333)
 - * Or use any unused User Val
 - Copy the Modbus address of this parameter by pressing the MAN button

2. In ANALOGUE OPERS/An 1* Page (section Analogue Operator Parameters)
 - set 'Input 2 Src' = 09220: UVal1.Val
 - The LOOP button will paste this value from the previous copy procedure.
 - * Or use any unused analogue operator
 - set 'Input 1 Src' = 04948: Mod6A.Val
 - set 'Operation' = Divide
 - This will divide the high level gauge signal by 1.333 to convert to mmHg.

3. In ANALOGUE OPERS/An 2* Page (section Analogue Operator Parameters)
 - set 'Operation' = Divide
 - set 'Input 1 Src' = 04468: Mod3A.Val
 - set 'Input 2 Src' = 09220: Uval1.Val
 - * Or use any unused analogue operator
 - This will divide the low level gauge signal by 1.333 to convert to mmHg.

4. In VACUUM/*High Vacuum* Page (section High Vacuum Parameter Tables)
 - set 'Gauge Src' = 06158 AnOp1.OP
 - This connects the high vacuum gauge PV from the analogue operator 1 output

5. In VACUUM/*Low Vacuum* Page (section Low Vacuum Parameter Tables)
 - set 'Gauge Src' = 06178 AnOp2.OP
 - This connects the low vacuum gauge PV from the analogue operator 2 output

6. In VACUUM/Display (section Vacuum Display Parameter Tables)
 - set 'Units' = mmHg
 - This configures the units shown on the banner to mmHg.

Text shown in *italics* may be customised

Input Operators

What are Input Operators

The 2704 controller can have three control loops. Each loop can be independently configured to the process to be controlled. This has been described in Chapters 12 and 13 for PID, Cascade, Ratio, Override, Humidity Control, etc. It is also possible to apply custom linearisation to the inputs of each loop. This is a 16 point straight line linearisation and the parameters can be made available at Levels 1, 2 and 3 so that scaling can be carried out during commissioning. There are three Custom linearisation pages.

Also included in this section are parameters which allow you to switch inputs between different thermocouple types or between a thermocouple and pyrometer when the process is a high temperature furnace.

The page headers are:

INPUT OPERS ▶	Cust Lin 1 Page	These parameters set up the custom linearisation for input 1
	Cust Lin 2 Page	These parameters set up the custom linearisation for input 2
	Cust Lin 3 Page	These parameters set up the custom linearisation for input 3
	Switch 1 Page	These parameters provide switch over between thermocouple types or pyrometer
	Monitor 1 Page	Logs maximum and minimum, counts time above threshold
	BCD Input	Monitors the Digital Inputs when configured for BCD switch

The Input Operators page is only available if Input Operators has been enabled in configuration level.

Note: In addition to linearising the controller inputs channels, it is equally valid to customise other sources such as Output Channels. This allows you, for example, to compensate for non-linear control valve characteristics.

Custom Linearisation

The linearisation uses a 16 point straight line fit.

Figure 76 shows an example of a curve to be linearised and is used to illustrate the terminology used for the parameters found in the **INPUT OPERS (Cust Lin1 Page)**.

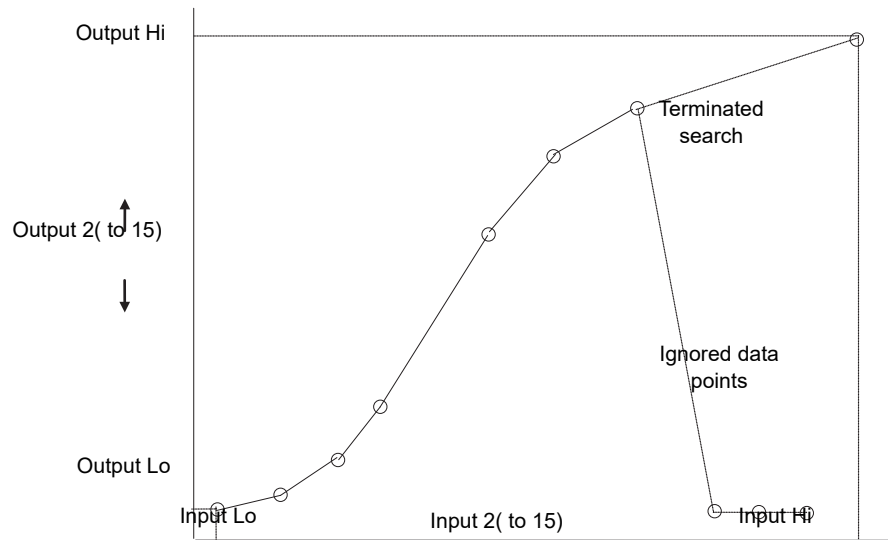

Figure 76 Linearisation Example

Notes:

1. The linearisation block works on rising inputs/rising outputs or rising inputs/falling outputs. It is not suitable for outputs which rise and fall on the same curve.
2. Input Lo/Output Lo and Input Hi/Output Hi are entered first to define the low and high points of the curve. It is not necessary to define all 15 intermediate points if the accuracy is not required. Points not defined will be ignored and a straight line fit will apply between the last point defined and the Input Hi/Output Hi point.

Compensation for Sensor Non-Linearities

The custom linearisation feature can also be used to compensate for errors in the sensor or measurement system. The intermediate points are, therefore, available in Level 1 so that known discontinuities in the curve can be calibrated out. Figure 77 shows an example of the type of discontinuity which can occur in the linearisation of a temperature sensor.

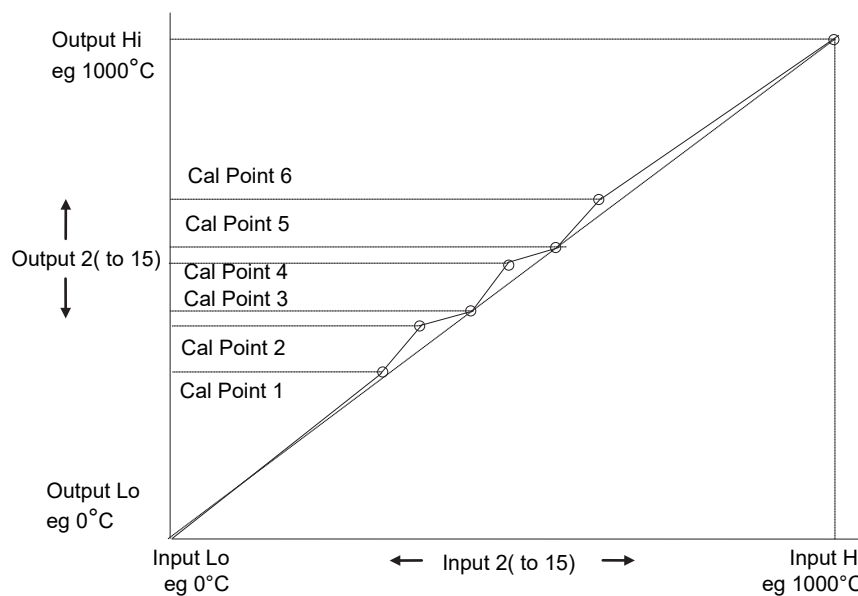



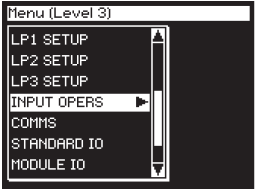

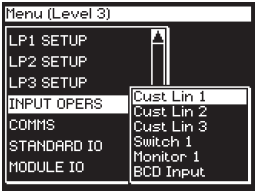



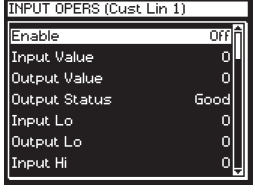

Figure 77 Compensation for Sensor Discontinuities

The calibration of the sensor uses the same procedure as described above. Adjust the output (displayed) value against the corresponding input value to compensate for any errors in the standard linearisation of the sensor.

To View and Adjust Input Operator Parameters

Do This	This Is The Display You Should See	Additional Notes
<ol style="list-style-type: none"> From any display press  as many times as necessary to access the page header menu Press  or  to select 'INPUT OPERS' 		<p>This page is only available if 'Input Opers' is Enabled in the INSTRUMENT (Options) page</p>
<ol style="list-style-type: none"> Press  to show Sub-headers 		<p>Cust Lin 1 Custom Cust Lin 2 linearisation Cust Lin 3 of inputs 1, 2 and 3 Switch 1 T/C to pyrometer switch over</p>
<ol style="list-style-type: none"> Press  or  to the required sub-header Press  to select the parameter list for the required sub-header 		<p>Monitor 1 Logs max., min. and time above threshold BCD Input For use with external BCD switch</p>

The full list of parameters available under these list headers is shown in the following tables:

Input Operator Custom Linearisation Parameters



Table 59:		This page allows you to set up a customised linearisation curve		LP1 SETUP Wiring Page	
Parameter Name	Parameter Description	Value	Default	Access Level	
Enable	To enable custom linearisation	Off On	Off	L3	
Input Src	Custom linearisation input source	Modbus address		Conf	
Output Units	Custom linearisation output units	See Appendix D.2.		Conf	
Output Resol	Custom linearisation output resolution	XXXXX XXXX.X XXX.XX XX.XXX		Conf	
Input Value	The current value of the input	Range		R/O L1	
Output Value	The current value of the output	Range		R/O L1	
Output Status	The conditions are OK The conditions are bad or out of range	Good Bad		R/O L1	
Input Lo	Adjust to the low input value	Range		L3	
Output Lo	Adjust to correspond to the low input value	Range		L3	
Input Hi	Adjust to the high input value	Range		L3	
Output Hi	Adjust to correspond to the high input value	Range		L3	
Input 2	Adjust to the first break point	Range		L1	
Output 2	Adjust to correspond to input 2	Range		L1	
The above two parameters are repeated for all intermediate break points, ie 3 to 14					
Input 15	Adjust to the last break point	Range		L1	
Output 15	Adjust to correspond to input 15	Range		L1	

The above table is repeated for:

- INPUT OPERS (Cust Lin 2 Page)
- INPUT OPERS (Cust Lin 3 Page)

Thermocouple/Pyrometer Switching

This facility is commonly used in wide range temperature applications where it is necessary to control accurately over the range. A thermocouple may be used to control at lower temperatures and a pyrometer then controls at very high temperatures. Alternatively two thermocouples of different types may be used.

Figure 78 shows a process heating over time with boundaries which define the switching points between the two devices. The higher boundary (2 to 3) is normally set towards the top end of the thermocouple range and the lower boundary (1 to 2) set towards the lower end of the pyrometer (or second thermocouple) range. The controller calculates a smooth transition between the two devices.

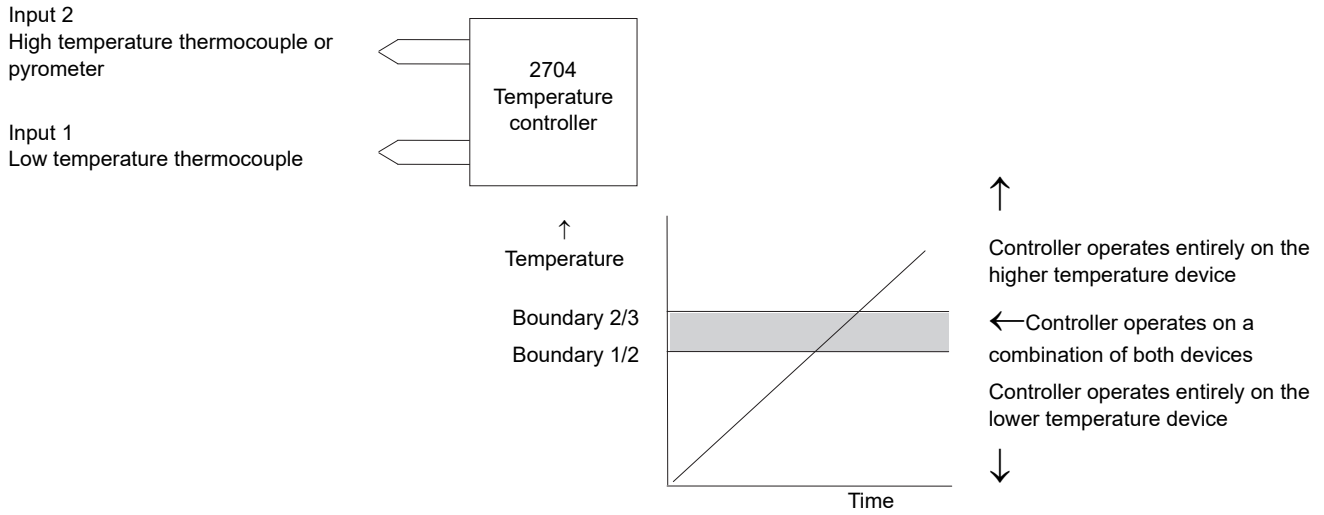

Figure 78 Thermocouple to Pyrometer Switching

Input Operators Switch Over Parameters

Table 60: These parameters allow you to soft wire between function blocks.		LP1 SETUP Wiring Page		
Parameter Name	Parameter Description	Value	Default	Access Level
Enable	To enable switch over	Off On	Off	Conf
Active Input	Selected input	Input 1 Input 2 Both Inputs		
Input 1 Src	Input 1 source	Modbus		Conf
Input 2 Src	Input 2 source	address		Conf
Input Lo	Display low limit	Display range		Conf
Input Hi	Display High limit	Display range		Conf
Switch Lo	PV = Input 1 below this value	Display range		L3
Switch Hi	PV = Input 2 above this value	Display range		L3
Switch Lo and Hi can be adjusted up to the limit set by 'Input Hi' and 'Input Lo' in configuration level or the limit set by 'Switch Lo' and 'Switch Hi'				
Output Value	The current working value	Display range		R/O L1
Output Status	The conditions are OK or out of range	Good Bad		R/O L1
Input 1 Value	The current working value Can be adjusted between the limits set by 'Input Lo' and 'Input Hi' in configuration level	Display range		R/O L1
Input 1 Status	The conditions are correct or out of range	Good Bad		R/O L1
Input 2 Value	The current working value Can be adjusted between the limits set by 'Input Lo' and 'Input Hi' in configuration level	Display range		R/O L1
Input 2 Status	The conditions are correct or out of range	Good Bad		R/O L1

To Set Up Input Operators (Monitor)

The Monitor block:

1. Logs the Maximum and Minimum excursions of the PV. These values are reset when:
 - a. An external logic input, configured as reset, is enabled
 - b. The reset parameter, see Table 61, is changed to Yes
2. Counts the time above a threshold
3. Provides a time alarm

Input Operator Monitor Parameters

Table 61: This page allows you to set up Monitor parameters.		INPUT OPERS (Monitor 1 Page)		
Parameter Name	Parameter Description	Value	Default	Access Level
Enable	Monitor enable	Disabled Enabled	Off	Conf
Input Src	Input source	Modbus addr		Conf
Reset Src	Reset source	Modbus addr		Conf
Input	Input value	Range		L1
Reset	Reset	No = to run Yes = to reset	No	L3
Maximum	The maximum value recorded by the controller between resets, see 1. above	Range		R/O L1
Minimum	The minimum value recorded by the controller between resets, see 1. above	Range		R/O L1
Trigger	PV threshold for timer log	Range		L3
Day	Days above threshold	0 to 32767		R/O L1
Time	Time above threshold	0:00:00.0		R/O L1
Day Alarm	This sets the alarm threshold for the number of days that the alarm is active	0 to 32767		L3
Time Alarm	This sets the alarm threshold for the time that the alarm is active	0:00:00.0		L3
Alarm Output	Displays an alarm when the number of days and time has been exceeded	Off On		R/O L1

BCD Input

An available option with the 2704 is the Binary Coded Decimal (BCD) function block. This feature is normally used to select a program number by using panel mounted BCD decade switches. A configuration example for this block is given in Section Configuring the BCD Input to Select a Program.

Main Features

Calculation of BCD Value: The function calculates a BCD value dependant upon the state of the inputs. Unconnected inputs are detected as off. This value is available as a wireable parameter.

Calculation of Decimal Value: The function calculates a decimal value dependant upon the state of the inputs. Unconnected inputs are detected as off. This value is available as a wireable parameter.

Digit 1 Output: The function calculates the first decade BCD value dependant on the state of inputs 1 to 4. Unconnected inputs are detected as off. This value is available as a wireable parameter.

Digit 2 Output: The function calculates the second decade BCD value dependant on the state of inputs 5 to 8. Unconnected inputs are detected as off. This value is available as a wireable parameter.

2 nd Decade	1 st Decade	BCD	Decimal	2 nd Digit	1 st Digit
0011	1001	39	57	3	9
0010	0110	26	38	2	6

BCD Parameters

Table 62: These parameters allow you to soft wire between function blocks.			INPUT OPERS (BCD Input Page)	
Parameter Name	Parameter Description	Value	Default	Access Level
Enable	BCD enable	Off On	Off	Conf
Input1 Src-LSB	Input 1 source (LSB)	Modbus address		Conf
Input2 Src	Input 2 source	Modbus address		Conf
Input3 Src	Input 3 source	Modbus address		Conf
Input4 Src	Input 4 source	Modbus address		Conf
Input5 Src	Input 5 source	Modbus address		Conf
Input6 Src	Input 6 source	Modbus address		Conf
Input7 Src	Input 7 source	Modbus address		Conf
Input8 Src-M	Input 8 source (MSB)	Modbus address		Conf
BCD Value	Reads the value (in BCD) of the switch as it appears on the digital inputs	0-99		R/O L1
Decimal Value	Reads the value(in decimal) of the switch as it appears on the digital inputs	0-255		R/O L1
Digit 1(units)	Units value of the first switch	0-9		R/O L1
Digit 2(Tens)	Tens value of the second switch	0-9		R/O L1

Input Operators Wiring Examples

Switch Over Loop With Custom Linearised Input

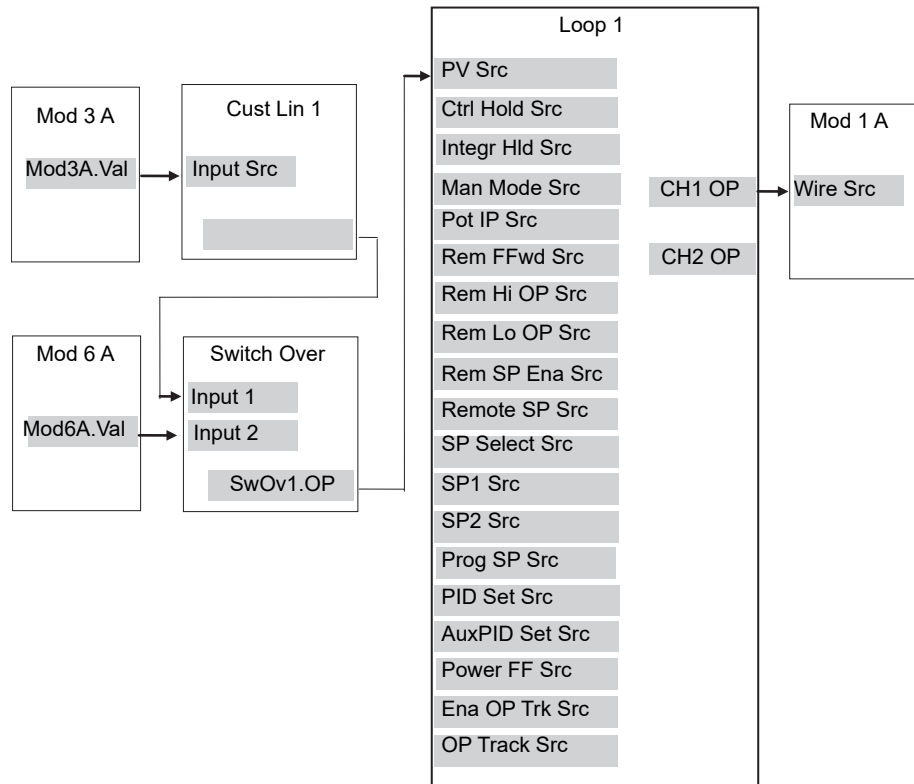

Figure 79 Example Wiring, Switch Over Loop with Custom Linearised Input

Implementation

1. In INPUT OPERS/Custom Lin 1 (section Input Operator Custom Linearisation Parameters), set 'Input Src' = 04468:Mod3A.Val (Appendix D)
This connects the input of the custom linearisation block to the output of Module 3A fitted as a PV input module.
2. In INPUT OPERS/Switch 1 Page (section Input Operators Switch Over Parameters) set 'Input 1 Src' = 03365:CLin1.OP (Appendix D)
This connects input 1 of the switch over block to the output of custom linearisation block 1.
3. In INPUT OPERS/Switch 1 Page (section Input Operators Switch Over Parameters) set 'Input 2 Src' = 04948:Mod6A.Val (Appendix D)
This connects input 2 of the switch over block to the output of module 6A fitted as an analogue input module.
4. In LOOP SETUP/Wiring Page (section Loop Set Up (Wiring Page) Single Loop) Set 'PV Src' = 03477:SwOv1.OP (Appendix D)
This connects the PV input of Loop 1 to the output of the switch over block.
5. In MODULE IO/Module 1A Page (section DC Control and DC Retransmission if analogue output) Set 'Wire Src' = 00004:L1.Wkg OP (Appendix D)
This connects the input of module 1A to channel 1 output of loop 1. This module may be fitted as an analogue, relay, triac or logic output.

See Appendix D for list of Modbus addresses.

☺Tip: See 'Copy and Paste' description in Soft Wiring.

Configuring the BCD Input to Select a Program

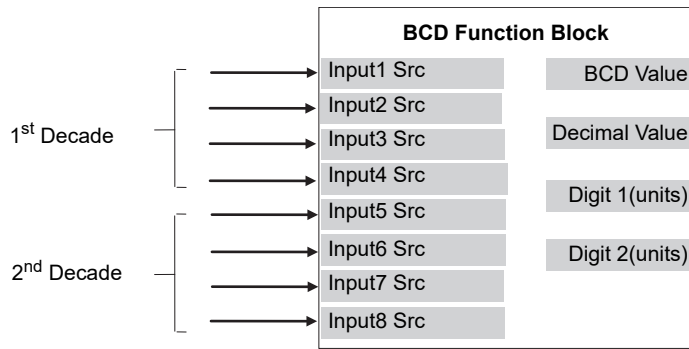

Figure 80 BCD Function Block

This example assumes that the digital inputs are connected to the standard IO.

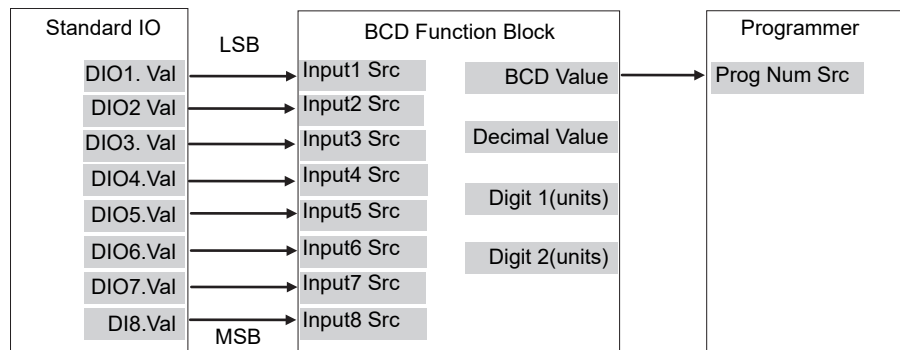

Figure 81 Wiring of Digital Inputs to the BCD Function Block

Implementation

- | | |
|--|--|
| <ol style="list-style-type: none"> 1. In PROGRAM EDIT/Options Page (section Program Edit Options Page) 2. In STANDARD IO/DI01 Page (section Standard Digital IO Parameters) 3. In STANDARD IO/DI02 Page 4. In STANDARD IO/DI03 Page 5. In STANDARD IO/DI04 Page 6. In STANDARD IO/DI05 Page 7. In STANDARD IO/DI06 Page 8. In STANDARD IO/DI07 Page 9. In INPUT OPERS/BCD Input Page (section BCD Parameters) 10. In INPUT OPERS/BCD Input Page 11. In INPUT OPERS/BCD Input Page 12. In INPUT OPERS/BCD Input Page 13. In INPUT OPERS/BCD Input Page 14. In INPUT OPERS/BCD Input Page 15. In INPUT OPERS/BCD Input Page 16. In INPUT OPERS/BCD Input Page 17. In INPUT OPERS/BCD Input Page 18. In PROGRAM EDIT/Wiring Page (section PROGRAM EDIT Wiring Page) | <p>set 'BCD Prg Num' = Yes</p> <p>set 'Channel Type' = Digital Input</p> <p>set 'Channel Type' = Digital Input</p> <p>set 'Channel Type' = Digital Input</p> <p>set 'Channel Type' = Digital Input</p> <p>set 'Channel Type' = Digital Input</p> <p>set 'Channel Type' = Digital Input</p> <p>set 'Channel Type' = Digital Input</p> <p>set 'Channel Type' = Digital Input</p> <p>set 'Enable' = On</p> <p>Set 'Input1 Src' = 05402:DIO1.Val</p> <p>Set 'Input2 Src' = 05450:DIO2.Val</p> <p>Set 'Input3 Src' = 05498:DIO3.Val</p> <p>Set 'Input4 Src' = 05546:DIO4.Val</p> <p>Set 'Input5 Src' = 05594:DIO5.Val</p> <p>Set 'Input6 Src' = 05642:DIO6.Val</p> <p>Set 'Input7 Src' = 05690:DIO7.Val</p> <p>Set 'Input8 Src' = 11313:DIO8.Val</p> <p>Set 'Prog Num Src' = 10450</p> <p><i>This connects the output of the BCD block to the program number.</i></p> |
|--|--|

Holdback Duration Timer

This procedure describes how to configure a 2704 controller, using the Monitor Block, to accumulate the total time that a program has been in holdback within a segment. A holdback timer can be used to inform the user his application is taking longer to heat up than normal, possibly indicating a problem with the heat source or unusually high losses.

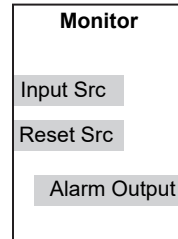

Figure 82 Monitor Function Block

The Monitor Block functions are as follows:

1. Logs the maximum and minimum excursions of its input value. These values are reset when:
 - a. the controller power is cycled
 - b. the block is reset
2. Counts the time above a threshold
3. Provides a time alarm

This example assumes that the controller has already been set up as a single loop programmer, and that program digital output 1 is used to enable the timer during certain segments. This is used to reset the monitor at the end of the segment. The maximum expected holdback time is set to 30 minutes. When this time is exceeded the AA relay is switched on.

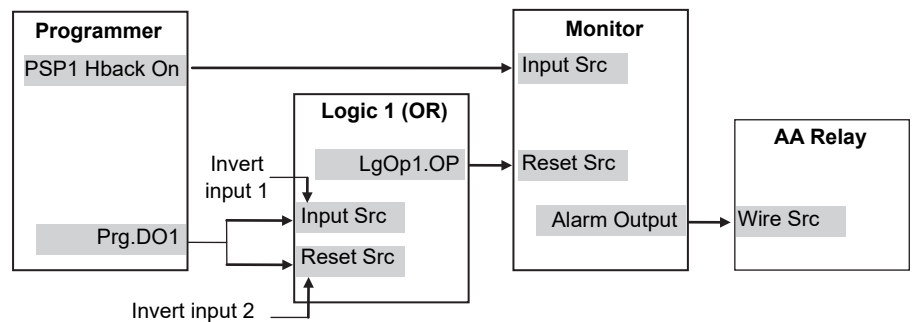

Figure 83 Example Wiring, Holdback Duration Timer

Implementation

1. In LOGIC OPERATORS/Logic 1 Page (section Logic Operator Parameters)
 - set 'Operation' = OR
 - set 'Input 1 Src' = 05869:Prg.DO1
 - set 'Input 2 Src' = 05869:Prg.DO1
 - set 'Invert' = Invert Both
 - This inverts the sense of Program DO1
2. In INPUT OPERS/Monitor 1 Page (section Input Operator Monitor Parameters)
 - Set 'Enable' = Enabled
 - Set 'Input Src' = 05804:
 - This connects PSP1 Holdback Status
 - Set 'Reset Src' = 07176:LgOp1.OP
 - This connects Logic 1 Output to the Monitor Reset
 - Set 'Trigger' = 1.0
 - Set 'Day Alarm' = 0
 - Set 'Time Alarm' = 0:30:00:0
3. In STANDARD IO/AA Relay Page (section Standard IO AA Relay Parameters)
 - Set 'Channel Type' = On/Off
 - Set 'Wire Src' = 03500:
 - This assigns AA Relay to Monitor OP

Timer, Clock, Totaliser, Operation

What are Timer Blocks?

Timer Blocks allow the controller to use time/date information as part of the control process. They can be triggered by an event and used to initiate an action. For example, a programmer can be set to RUN at a particular day and time or an action delayed as a result of a digital input signal. The Timer Blocks page is only available if Timer Blocks has been enabled in configuration level. The Timer Blocks fitted in the 2704 controller are:

Four timer blocks	Timer blocks can have four modes of operation which are explained in Section Timer Types. The timer type is set in Configuration level. The timer is activated by an event. The event is also defined in Configuration mode or it may be triggered by a parameter in the list. Timing continues for a set time period. The output can be 'wired' in configuration mode to operate a further event.
Clock	This is a real time clock which can be used to operate other time based functions.
Two alarm (clock) blocks	Alarms can be switched on or off at a particular day or time and provide a digital output. The alarm output can be wired in configuration mode to operate an event.
Four totaliser blocks	Totaliser blocks can also be 'wired', in Configuration level, to any parameter. They are used to provide a running total of a parameter and give an output when a pre-set total is reached. An example might be to totalise the flow through a pipe. The output can also be 'wired' in Configuration level to operate an event such as a relay.

Timer Blocks are grouped under page headers as follows:

TIMER BLOCKS ▶	Timer 1 Page	Parameters to set the time period and read elapsed time for timer 1
	Timer 2 Page	Parameters to set the time period and read elapsed time for timer 2
	Timer 3 Page	Parameters to set the time period and read elapsed time for timer 3
	Timer 4 Page	Parameters to set the time period and read elapsed time for timer 4
	Clock Page	To set time and day
	Alarm 1 Page	Parameters to set a time and day alarm and read the alarm output condition for alarm 1
	Alarm 2 Page	Parameters to set a time and day alarm and read the alarm output condition for alarm 2
	Totaliser1 Page	Parameters to read the totalised value, set and monitor an alarm on totalised value.
	Totaliser2 Page	Parameters to read the totalised value, set and monitor an alarm on totalised value.
	Totaliser3 Page	Parameters to read the totalised value, set and monitor an alarm on totalised value.
	Totaliser4 Page	Parameters to read the totalised value, set and monitor an alarm on totalised value.

Timer Types

Each timer block can be configured to operate in four different modes. These modes are explained below

On Pulse Timer Mode

This timer is used to generate a fixed length pulse from an edge trigger.

- The output is set to On when the input changes from Off to On.
- The output remains On until the time has elapsed
- If the 'Trigger' input parameter recurs while the Output is On, the Elapsed Time will reset to zero and the Output will remain On
- The triggered variable will follow the state of the output

Figure 84 illustrates the behaviour of the timer under different input conditions.

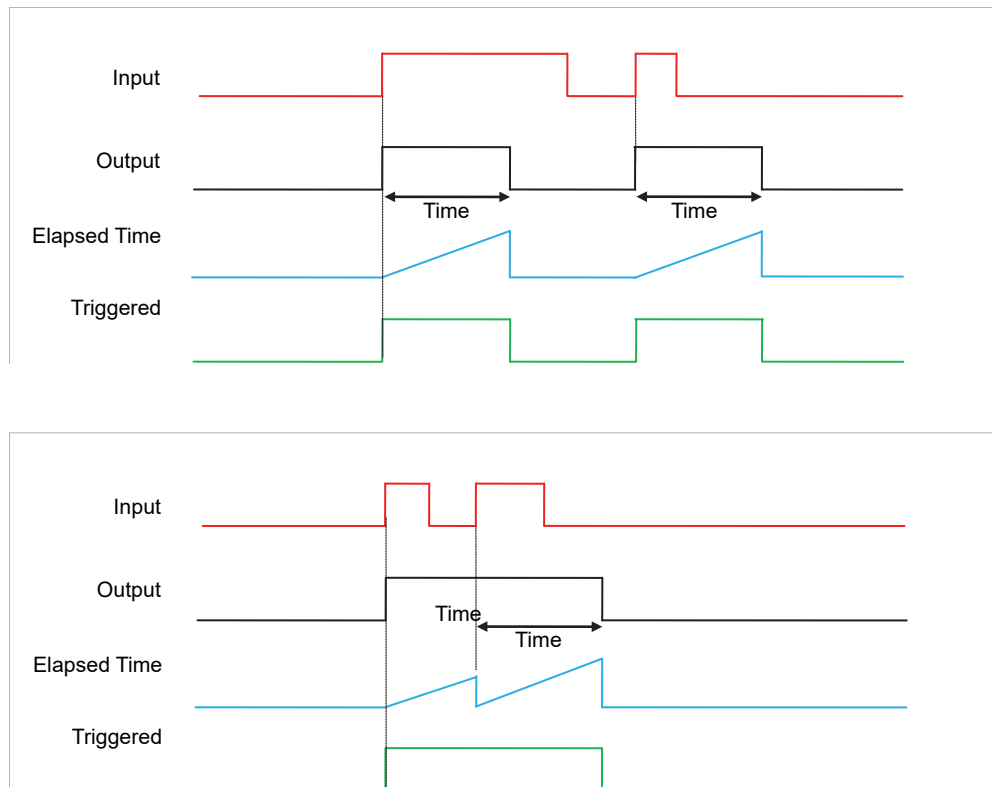

Figure 84 On Pulse Timer Under Different Input Conditions

Off Delay Timer Mode

This timer provides a delay between the trigger event and the Timer output. If a short pulse triggers the Timer, then a pulse of one sample time (110ms) will be generated after the delay time.

- The Output is set to Off when the Input changes from Off to On.
- The Output remains Off until the Time has elapsed.
- If the Input returns to Off before the time has elapsed, the Timer will continue until the Elapsed Time equals the Time. It will then generate a pulse of one Sample Time duration.
- Once the Time has elapsed, the Output will be set to On.
- The Output will remain On until the Input is cleared to Off.
- The Triggered variable will be set to On by the Input changing from Off to On. It will remain On until both the Time has elapsed and the Output has reset to Off.

Figure 85 illustrates the behaviour of the timer under different input conditions.

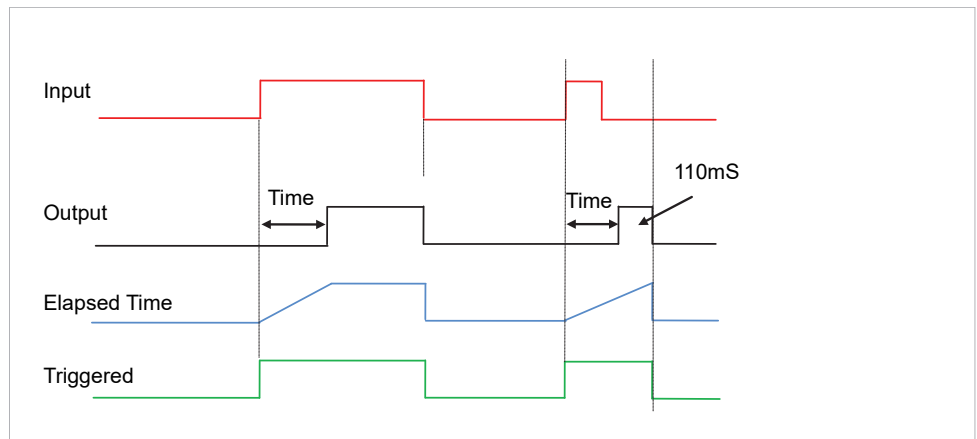

Figure 85 Off Delay Timer Under Different Input Conditions

One Shot Timer Mode

This timer behaves like a simple oven timer.

- When the Time is edited to a non-zero value the Output is set to On
- The Time value is decremented until it reaches zero. The Output is then cleared to Off
- The Time value can be edited at any point to increase or decrease the duration of the On time
- Once set to zero, the Time is not reset to a previous value, it must be edited by the operator to start the next On-Time
- The Input is used to gate the Output. If the Input is set, the time will count down to zero. If the Input is cleared to Off, then the Time will hold and the Output will switch Off until the Input is next set.

Note: Since the Input is a digital wire, it is possible for the operator to NOT wire it, and set the Input value to On which permanently enables the timer.

- The Triggered variable will be set to On as soon as the Time is edited. It will reset when the Output is cleared to Off.

The behaviour of the timer under different input conditions is shown below.

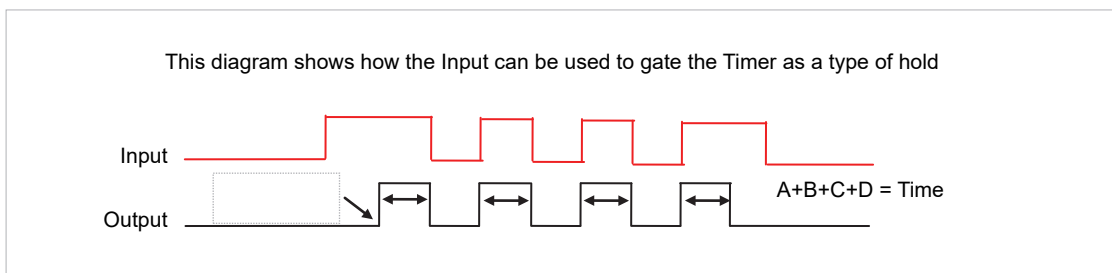
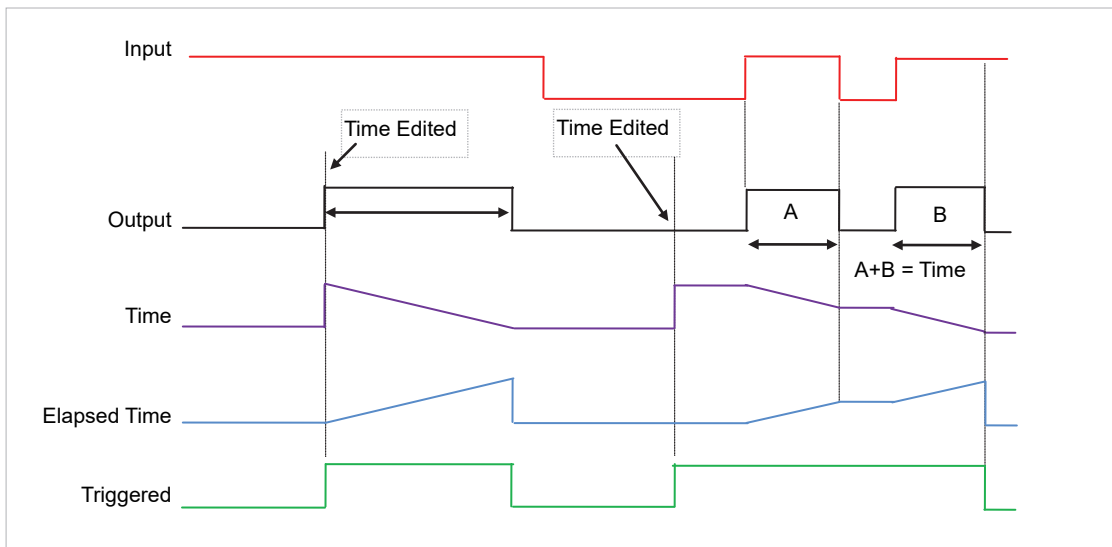

Figure 86 One Shot Timer

Compressor or Minimum On Timer Mode

This timer has been targeted at guaranteeing that the output remains On for a duration after the input signal has been removed. It may also be known as an ‘Off Delay’ timer and may be used, for example, to ensure that a compressor is not cycled excessively.

- The output will be set to On when the Input changes from Off to On.
- When the Input changes from On to Off, the elapsed time will start incrementing towards the set Time.
- The Output will remain On until the elapsed time has reached the set Time. The Output will then switch Off.
- If the Input signal returns to On while the Output is On, the elapsed time will reset to 0, ready to begin incrementing when the Input switches Off.
- The Triggered variable will be set while the elapsed time is >0. It will indicate that the timer is counting.

Figure 87 illustrates the behaviour of the timer under different input conditions.

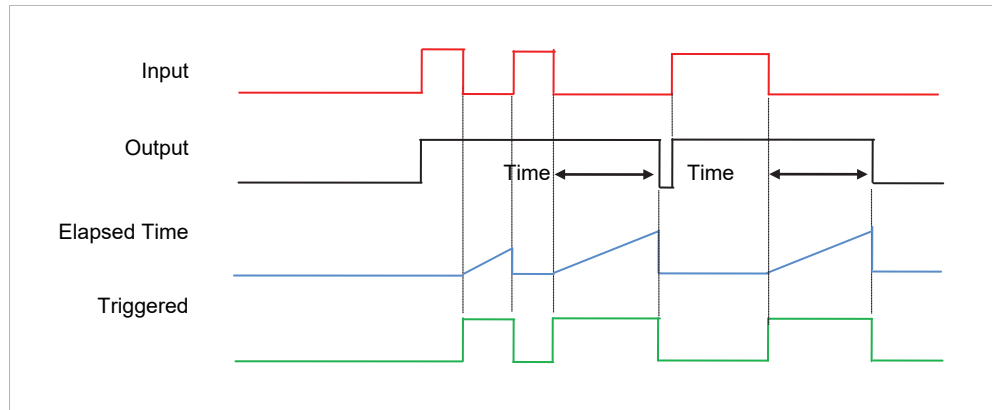



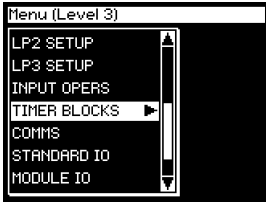



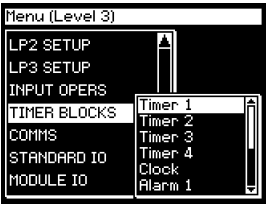

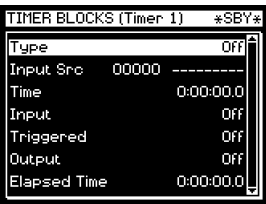

Figure 87 Minimum On Timer Under Different Input Conditions

To View and Adjust Timer Parameters

Do This	This Is The Display You Should See	Additional Notes																						
1. From any display press  as many times as necessary to access the page header menu 2. Press  or  to select 'TIMER BLOCKS'		This page is only available if 'Timer Blocks is Enabled in the INSTRUMENT (Options) page																						
3. Press  to show Sub-headers 4. Press  or  to scroll to the required sub-header		<table border="0"> <tr><td>Timer 1</td><td>To configure</td></tr> <tr><td>Timer 2</td><td>timer types</td></tr> <tr><td>Timer 3</td><td>and</td></tr> <tr><td>Timer 4</td><td>parameters</td></tr> <tr><td>Clock</td><td>To set time and day</td></tr> <tr><td>Alarm 1</td><td>To wire and</td></tr> <tr><td>Alarm 2</td><td>set alarm outputs</td></tr> <tr><td>Totaliser 1</td><td>To wire and</td></tr> <tr><td>Totaliser 2</td><td>set totaliser</td></tr> <tr><td>Totaliser 3</td><td>1, 2, 3 & 4</td></tr> <tr><td>Totaliser 4</td><td>parameters</td></tr> </table>	Timer 1	To configure	Timer 2	timer types	Timer 3	and	Timer 4	parameters	Clock	To set time and day	Alarm 1	To wire and	Alarm 2	set alarm outputs	Totaliser 1	To wire and	Totaliser 2	set totaliser	Totaliser 3	1, 2, 3 & 4	Totaliser 4	parameters
Timer 1	To configure																							
Timer 2	timer types																							
Timer 3	and																							
Timer 4	parameters																							
Clock	To set time and day																							
Alarm 1	To wire and																							
Alarm 2	set alarm outputs																							
Totaliser 1	To wire and																							
Totaliser 2	set totaliser																							
Totaliser 3	1, 2, 3 & 4																							
Totaliser 4	parameters																							
5. Press  to select the parameter list for the required sub-header																								

The full list of parameters available under these list headers is shown in the following tables:

Timer Parameters

Table 63: This page allows you to configure timer type and set up Timer Parameters			TIMER BLOCKS (Timer 1 to 4 Page)	
Parameter Name	Parameter Description		Default	Access Level
Type	Timer type	Off On Pulse Timer Off Delay Timer One Shot Timer Min-On Timer	Off	Conf
Input Src	Timer input wire source	Modbus address		Conf
Time	Timer Time	0:00:00.0		L1
Input	Trigger/Gate input. Turn On to start timing	Off On	Off	L1
Triggered	Timer triggered (timing)	Off On		R/O L1
Output	Timer output. Occurs when the timer has timed out	Off On	Off	L1
Elapsed Time	Timer elapsed time	0:00:00.0		R/O L1

The above table is repeated for Timers 2 to 4.



To change hours, minutes and seconds individually, press and together.

This will highlight each area individually. Then use or to change the highlighted value.

The maximum settable time is 99:59:59.9

The Clock

A real time clock is provided for use with various timer functions in the controller.

Clock Parameters

Table 64: This page allows you to configure the clock			TIMER BLOCKS (Clock Page)	
Parameter Name	Parameter Description		Default	Access Level
Mode	Real time clock mode	Run Stop Set		L3
Time	Real time clock time	HH:MM:SS		L1 R/O when Mode =Set
Day	Real time clock day	Never Monday Tuesday Wednesday Thursday Friday Saturday Sunday Mon-Fri Mon-Sat Sat-Sun Every Day		L1 R/O when Mode =Set

Time Based Alarms

There are two alarms available which allow an output to be turned on or off at a set time and day.

Timer Alarm Parameters

Table 65: This page allows you to set up Timer Alarm Parameters			TIMER BLOCKS (Alarm 1 or 2 Page)	
Parameter Name	Parameter Description	Value	Default	Access Level
Enable Src	Enable input wire source	Modbus address	None	Conf
Enable	RTC Alarm 1 Enable Enables the timer alarm	Off On	Off	L1
On-Day	Sets the day to turn the alarm on	Never Monday Tuesday Wednesday Thursday Friday Saturday Sunday Mon-Fri, Mon-Sat Sat-Sun Every Day	Never	L3
On-Time	Sets the time of day to turn the alarm on	0:00:00 to 23:59:59	0:00:00	L3
Off-Day	Sets the day to turn the alarm off	Never Monday Tuesday Wednesday Thursday Friday Saturday Sunday Mon-Fri, Mon-Sat Sat-Sun Every Day	Never	L3
Off-Time	Sets the time of day to turn the alarm off	0:00:00 to 23:59:59	0:00:00	L3
Output	Alarm 1 output	Off On	Off	L1

Totalisers

There are four totaliser function blocks which are used to measure the total quantity of a measurement integrated over time. A totaliser can, by soft wiring, be connected to any measured value. The outputs from the totaliser are its integrated value, and an alarm state. The user may set a setpoint which causes the alarm to activate once the integration exceeds the setpoint.

The totaliser has the following attributes:-

1. Run/Hold/Reset

In Run the totaliser will integrate its input and continuously test against an alarm setpoint.

In Hold the totaliser will stop integrating its input but will continue to test for alarm conditions.

In Reset the totaliser will be zeroed, and alarms will be reset.

2. Alarm Setpoint

If the setpoint is a positive number, the alarm will activate when the total is greater than the setpoint.

If the setpoint is a negative number, the alarm will activate when the total is lower (more negative) than the setpoint.

If the totaliser alarm setpoint is set to 0.0, the alarm will be off. It will not detect values above or below.

The alarm output is a single state output. It may be cleared by resetting the totaliser, or by changing the alarm setpoint.

3. The total is limited to a maximum of 99999 and a minimum of -9999.

Totaliser Parameters

Table 66: This page allows you to set up Totaliser Parameters			TIMER BLOCKS (Totaliser1 (to 4) Page)	
Parameter Name	Parameter Description	Value	Default	Access Level
Input Src	Totaliser monitored parameter source	Modbus address		Conf
Reset Src	Totaliser reset source	Modbus address		Conf
Run Src	Totaliser run source	Modbus address		Conf
Hold Src	Totaliser hold source	Modbus address		Conf
Units	Totaliser units	See Appendix D2		Conf
Resolution	Totaliser resolution	XXXXX XXXX.X XXX.XX XX.XXX X.XXXX	XXXXX	Conf
Reset	Resets the totaliser	No Yes	No	L1
Run	Runs the totaliser	Run Reset	Reset	L1
Hold	Holds the totaliser at its current value Note: The Run & Hold parameters are designed to be wired to (for example) digital inputs. Run must be 'on' and Hold must be 'off' for the totaliser to operate.	Hold Continue	Hold	L1
Total	This shows the totalised value	99999 to -9999		L1
Alarm Setpoint	Sets the totalised value at which an alarm will occur			L3
Alarm Output	This is a read only value which indicates the alarm output On or Off. The totalised value can be a positive number or a negative number. If the number is positive the alarm occurs when Total > + Alarm Setpoint If the number is negative the alarm occurs when Total > - Alarm Setpoint	Off On	Off	L1
Input Val	Totaliser monitored value	-9999 to 99999		L1

Application Example

Compressor Timer

This example uses the Min-On Timer to start a compressor in an environmental chamber. The compressor must be kept running for 5 to 15 minutes after the controller stops calling for cooling. If the controller starts to call for cooling again the “compressor timeout” timer deactivates until the cooling turns off again. The same action is required for dehumidification.

Implementation

This example assumes that the controller has already been set up as a 2 loop temperature and humidity controller. The controller will call for the compressor to be switched on when either the cool or de-humidify outputs are switched on. The cool output is DIO1 and the de-humidify output is DIO2. The compressor output is the AA Relay.

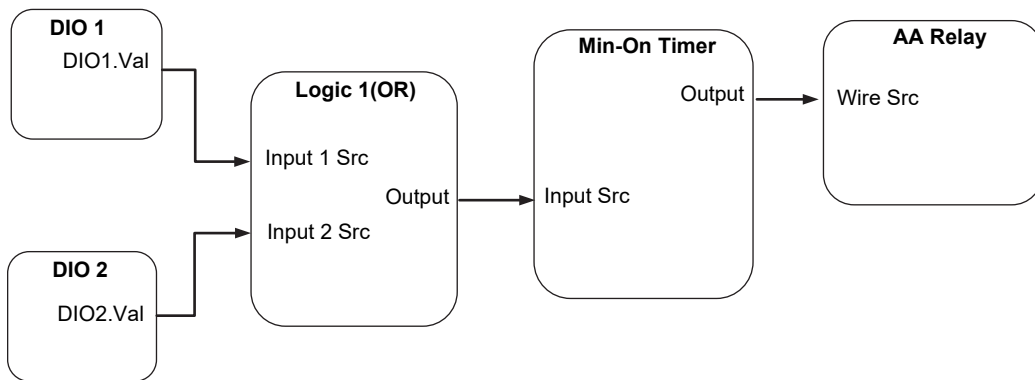

Figure 88 Compressor Timer Graphical Wiring

Enter Config Mode	
In LOGIC OPERS/Logic 1 Page (section Logic Operator Parameters)	Set "Operation" = OR Set "Input 1 Src" = 05402:----- Set "Input 2 Src" = 05450:----- <i>(Connects cool and dehumidify outputs to the logic operator)</i>
In TIMER BLOCKS/Timer 1 Page (section Timer Parameters)	Set "Type" = Min-On Timer Set "Input Src" = 07176: LgOp1.OP Set "Time" = 0:10:00:0 <i>(Uses logic 1 to trigger timer)</i>
In STANDARD IO/AA Relay Page (section Standard IO AA Relay Parameters)	Set "Channel Type" = On/Off Set "Wire Src" = 08963: Tmr1.OP <i>(Assigns AA Relay to Timer1 OP)</i>

Advanced Functions

Pattern Generator

The pattern generator allows groups of digital values to be selected from a single input number. This number is displayed as 'Pattern' and may be given a name, using the 'User Text' feature described in section Instrument User Text Page. This is known as a 'User Enumeration'.

An example of an application for the Pattern Generator would be to allow fixed output patterns to be applied in different segments of a program. This may be useful where the same pattern is repeated in different segments or in other programs. It is achieved by soft wiring (see Soft Wiring) to the 'Pattern Src' as shown in the example below.

The pattern generator consists of 16 patterns displayed as 'Pattern 0' to 'Pattern 15'. Each pattern consists of up to 16 digital outputs and any two patterns, displayed as 'Dig Group 1' and 'Dig Group 2', can be active at any one time.

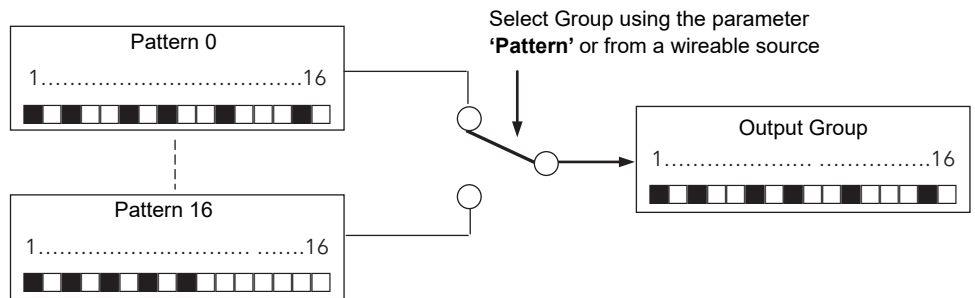

Figure 89 Digital Pattern Generator

Example: Programmer Event Outputs

In this example Program User Values are used to select the output pattern. The outputs of the pattern generator are wired to relay outputs of an IO Expander, see also IO Expander. When Program User Value 1 = 0 then the digital values of pattern 0 will be active. When Program User Value 1 = 1 the digital values of pattern 1 will be active, and so on.

The patterns can also be enumerated so that each can be assigned a name. This will allow the operator to select, say, the "Heating Pattern" to be active within a program segment.

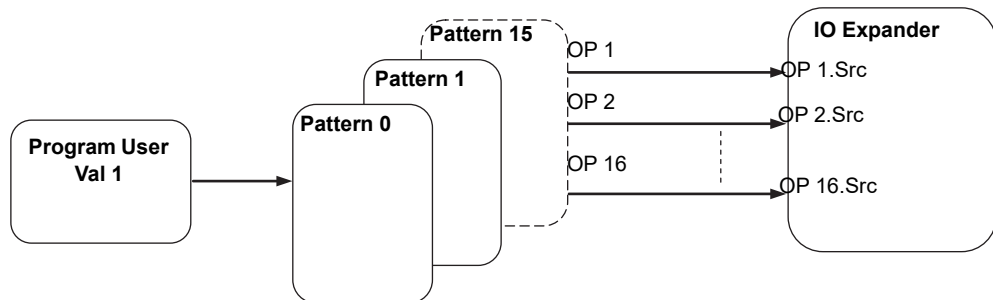











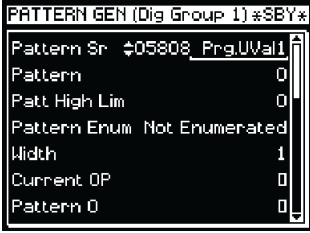



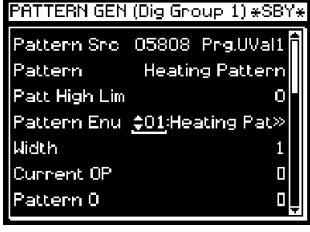



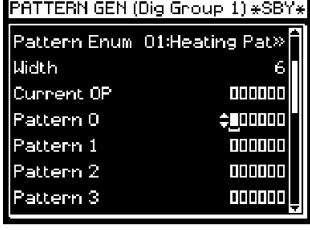

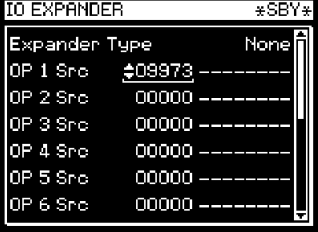

Figure 90 Pattern Selected by Programmer User Values

To Configure the Pattern Generator

Do This	This Is The Display You Should See	Additional Notes	
<p>1. From any display press  as many times as necessary to access the page header menu</p> <p>2. Press  or  to select 'PATTERN GENERATOR'</p>		<p>The PATTERN GEN page is only available if Enabled as described in section To Configure Controller Options.</p>	
<p>3. Press  to show Sub-headers</p> <p>4. Press  or  to select 'Dig Group 1 (or 2)'</p>			
<p>5. Press  to show the parameter list.</p> <p>6. Press  again to select 'Pattern Src'</p> <p>7. Press  or  to select the Modbus address of the parameter you wish to wire to</p>			<p>Programmer User Value 1 is wired to the Pattern Source</p> <p>'Pattern' is read only when wired. It can only be used to select the pattern if it is not wired.</p> <p>'Pattern High Lim' can be used to limit the number of patterns in any particular application. A limit of 8 allows patterns 0 to 7</p>
<p>8. Press  to show 'Pattern Enu'</p> <p>9. Press  or  to select the 'User Text' which contains the appropriate message</p>			<p>This parameter allows you to select a name (or 'Enumeration') for the pattern.</p> <p>See also section User Text Examples for User Text examples and section Custom Enumerations for enumeration examples.</p>
<p>10. Press  to select the first pattern - 'Pattern 0'</p> <p>11. Press  or  to change to change the first digit in the pattern to On (■) or Off (□)</p>		<p>'Width' limits the number of digits in each pattern – six in this example.</p> <p>'Current OP' displays the currently selected output</p> <p>Repeat the above to set up further patterns</p>	

To Wire Pattern Generator Outputs to the IO Expander Inputs

Do This	This Is The Display You Should See	Additional Notes																
<p>12. Enable the IO Expander in INSTRUMENT (Options) page</p> <p>13. Scroll to the IO EXPANDER page</p> <p>14. Select expander type e.g. 10 in 10 out and confirm as instructed</p> <p>15. Scroll to OP1 Src</p> <p>16. Press  or  to select the modbus address of Pattern Generator Digital OP 1</p>	 <p>☺Tip: Use the copy and paste procedure described in section Status Messages to select these parameters</p>	<p>The PATTERN GEN page is only available if Enabled as described in section To Configure Controller Options</p> <table border="1" style="width: 100%; border-collapse: collapse; text-align: center;"> <thead> <tr> <th colspan="2">Group 1</th> </tr> </thead> <tbody> <tr> <td>OP 1</td> <td>9973</td> </tr> <tr> <td>to</td> <td>to</td> </tr> <tr> <td>OP16</td> <td>9988</td> </tr> <tr> <th colspan="2">Group 2</th> </tr> <tr> <td>OP 1</td> <td>10037</td> </tr> <tr> <td>to</td> <td>to</td> </tr> <tr> <td>OP16</td> <td>10052</td> </tr> </tbody> </table>	Group 1		OP 1	9973	to	to	OP16	9988	Group 2		OP 1	10037	to	to	OP16	10052
Group 1																		
OP 1	9973																	
to	to																	
OP16	9988																	
Group 2																		
OP 1	10037																	
to	to																	
OP16	10052																	

Analogue Switches

Analogue Switches allow groups of analogue values to be selected from a single input number. This number may be provided from a user defined analogue source. or, if not wired, the analogue values can be selected from this number. As with the Pattern Generator the switch can be given a user defined name using the 'User Enumeration' feature.

There are 8 Analogue Switches, displayed as 'Switch 1' to 'Switch 7', and each switch can store up to 8 values displayed as 'Value 0' to 'Value 8'.

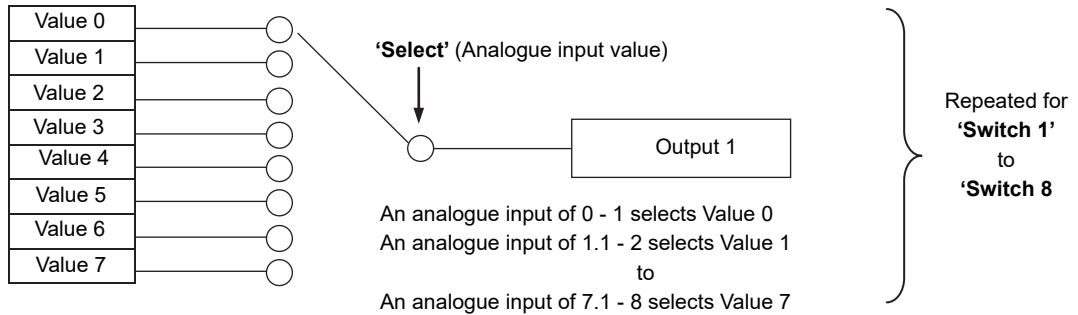



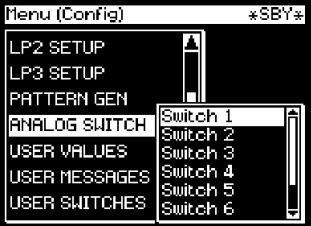



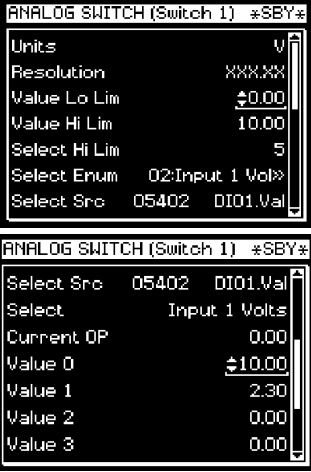

Figure 91 Representation of an Analogue Switch

To Set Up an Analogue Switch

Do This	This Is The Display You Should See	Additional Notes
<p>1. From any display press  as many times as necessary to access the page header menu. and  to show sub-headers</p> <p>2. Press  or  to select the required switch, e.g. 'Switch 1'</p>		<p>The ANALOG SWITCH page is only available if Enabled as described in section To Configure Controller Options.</p>
<p>3 Using  button to scroll to the required parameter and  or  buttons to change the value of the parameter set up the values as required</p>		<p>The example shown here sets Switch 1 as follows:-</p> <p>Switch 1 is named 'Input 1 Volts', and its values can be set between 0.00 and 10.00 volts.</p> <p>'Select Hi Lim' = 5 allows the first 6 values to be selected</p> <p>If an out of range 'Select' value is delivered by the 'Select Src' (when wired) 'Current OP' is always set to value 0. i.e. value 0 could be configured as the safe state value.</p>

User Values

User Values are normally used as constants in analogue or digital operations.







In an analogue operation the User Value may be used as a constant in a calculation.

In a digital operation it may be used to select an event. For example, it could be used to select a pattern from the pattern generator in the same way as the Programmer User Value was used in example 14.1.1. In this example the 'Program User Val 1' would be replaced by the 'User (1 to 12) Value'.

Each User Value can be given a user defined name using the 'User Enumeration' feature. This feature is generally intended for use when the User Value is used in a digital operation.

The 2704 controller contains up to 12 user values, which are in a single list under the page header 'USER VALUES'.

To Access User Values

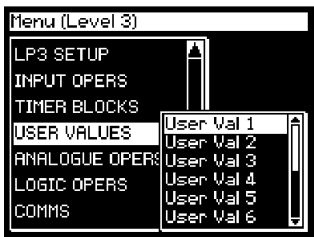
Do This	This Is The Display You Should See	Additional Notes
<p>1. From any display press  as many times as necessary to access the page header menu</p> <p>2. Press  or  to select 'USER VALUES'</p>		<p>The USER VALUES page is only available if Enabled as described in section To Configure Controller Options.</p>
<p>3. Press  to show Sub-headers</p> <p>4. Press  or  to select 'User Val 1 (to 12)'</p>		

The list of User Value parameters available under this list header is shown in the following table:

User Values Parameter Table

Table 67:	This page allows you to configure User Values		USER VALUES (User Val 1 Page)	
Parameter Name	Parameter Description	Value	Default	Access Level
Units	User value units	User value units		Conf
Resolution	User values resolution	XXXXX XXXX.X XXX.XX XX.XXX		Conf
Low Limit	User values low limit	Display min to display max		Conf
High Limit	User values high limit	Display min to display max		Conf
User 1 Value	User 1 Value	Low Limit to High Limit		L1
User Val Enu	Allows a name, chosen from User Text, to be given to the User Value	Not Enumerated 01:Usr1 to 50:Usr50	Not Enumerated	Conf

The above table is repeated for User Values 2 to 12.

Note: It is often required to generate a User Value = 1, and to wire this from a source. A User Value can be used for this but this takes up one or more of the User Values available.

An alternative is to use the parameter 'Const.1' which is a User Value = 1. This parameter is listed in Appendix D.

- ☺ When using Custom Enumerations the Resolution should not be set to more than one decimal point since the User Text library is limited to 50 strings. See also Example 16.6.1.3.

User Messages

A User Message takes the form of a pop window which will be displayed in operation level as a result of a particular action occurring. The format of this window is shown below:

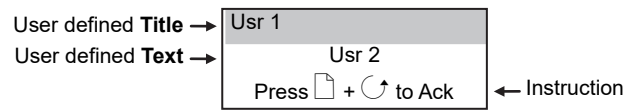











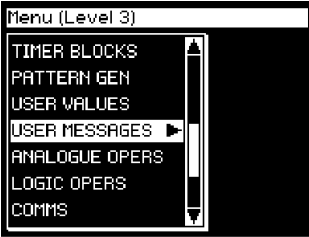









This is a similar format to that which occurs, for example, when an alarm occurs. This message, however, can be displayed when a particular event - defined by the user - occurs. For example, a User Message can be displayed if it has been wired to a digital input to alert an operator to a particular event.

User messages can only be set up in configuration level. They can, however, be inspected in Level 1.

Up to eight User Messages can be configured. Message 1 has a higher priority than Message 2 and so on.

To Configure a User Message









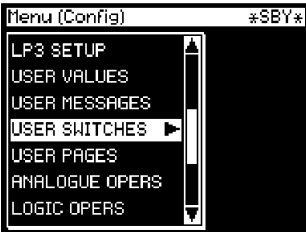

Do This	This Is The Display You Should See	Additional Notes
<p>1. From any display press  as many times as necessary to access the page header menu</p> <p>2. Press  or  to select 'USER MESSAGES'</p>		
<p>3. Press  to show Sub-headers</p> <p>4. Press  or  to select 'Msg 1 (to 8)'</p>		
<p>5. Press  to show the parameter list</p> <p>6. Press  again to select 'Title'</p> <p>7. Press  or  to choose a user defined text set up as described in section Instrument User Text Page.</p> <p>8. Press  to select 'Text'</p> <p>9. Press  or  to choose a user defined text set up as described in section Instrument User Text Page.</p> <p>10. Press  to select 'Show Msg (Src)'</p> <p>11. Press  or  to choose the Modbus address of the parameter which will trigger the message when the controller is in operation mode</p>		<p>In operation mode a pop up window, as shown below, will be displayed when digital input 1 is true.</p> <div data-bbox="1082 936 1350 1037" style="border: 1px solid black; padding: 5px; margin: 10px 0;"> <p style="text-align: center;">Danger</p> <p style="text-align: center;">Vent Open</p> <p style="text-align: center;">Press  +  to Ack</p> </div> <p>If 'Timeout' is set to a value of: 5 sec 10 sec 1 min 5 min or 10 min</p> <p>the user message will disappear after this period and will only re-appear when the digital input becomes true once more.</p> <p>The parameters 'Show Msg' and 'Dismissed' are intended for use over digital communications.</p>

User Switches

User Switches are similar to User Values when the User Value is used in a digital operation. They may, however, be configured as Auto Resetting or Manual Resetting and typically utilised in 'User Pages' (see User Pages) to perform a specified task. A User Switch can be given a user defined name using the 'User Enumeration' feature described in previous pages.

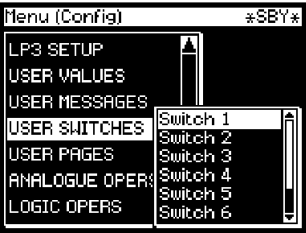
Up to eight User Switches are available

To Configure User Switches

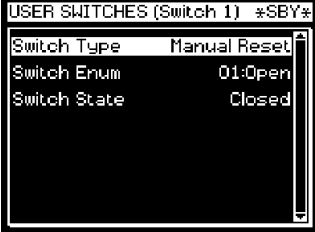
Do This	This Is The Display You Should See	Additional Notes
<ol style="list-style-type: none"> From any display press  as many times as necessary to access the page header menu Press  or  to select 'USER SWITCHES' 		<p>The USER SWITCHES page is only available if Enabled as described in section To Configure Controller Options</p>
<ol style="list-style-type: none"> Press  to show Sub-headers Press  or  to select 'Switch 1 (to 8)' 		
<ol style="list-style-type: none"> Press  to show the parameter list Press  again to select the required parameter Press  or  to change the parameter value 		<p>In this view the Switch Type is configured as Manual Reset. The alternative choice is Auto Reset.</p> <p>The switch enumeration is chosen from User Text as '01:Open'.</p> <p>The Switch State toggles between User Text 01 and the next User Text 02.</p> <p>In this example User Text 02 is configured as 'closed' so that the switch toggles between Open and Closed.</p>

Custom Enumerations

'Custom Enumerations' allow a user to enumerate parameter values with their own text.



Parameters which support custom enumerations are:-

- Program User Values – see section Program User Values
- Digital Pattern Generator Inputs – see section Pattern Generator
- Analogue Switches – see section Analogue Switches
- User Switches – see section User Switches
- Digital Programmer Select parameter – see section To Edit The Digital Programmer.
- Digital IO Status parameters (Enumeration) – see sections Standard IO AA Relay Parameters, Standard IO AA Relay Parameters, Relay Output, Triac Output, and Triple Logic Output and Single Isolated Logic Output
- Logic Operator 'Output Value' parameters – see section Logic Operator Parameters.

To Configure Custom Enumerations

This consists of two operations:-

1. Define areas of text in the INSTRUMENT/User Text page which are to be used for custom enumerations as follows:

In INSTRUMENT/User Text page, (section Instrument User Text Page) Set User Text = Enabled
 Set 'Text Number' (from 1 to 50) to represent the beginning of the text area
 Configure the 'Text' for the required message using the  or  buttons to change the text and the  button to move to the next character

The full procedure for this is described in section Instrument User Text Page.

User Text 01	Rough Valve Open
User Text 02	Rough Valve Closed
User Text 03	Diff Pump Run
User Text 04	Diff Valve open
User Text 05	Chamber Temp
User Text 06	Start Program
User Text 07	Start
User Text 08	Pre Heat
User Text 09	Stabilise
User Text 10	Heat Ramp
User Text 11	Annealing
User Text 12	Cool Ramp
User Text 13	Complete

← This table shows an example of a text area

2. Set up a pointer which defines the start point from which the text is to be selected and the range of the user text, as follows:-

- Choose the parameter to be enumerated, for example, 'Pattern Enum' in the PATTERN GEN (Dig Group 1 page)
- Define the range of the user text
- Choose the start point from which the user text is to be taken. Using the table below this user Text 08: Pre-Heat



The 'Pattern' name will be selected between User Text 08 (start pointer) and User Text 12 (Pattern High Limit)

Pattern high limit defines the number of enumerations
A Pattern high limit of 4 = 0 to 4 i.e. 5 enumerations

- User Text 01 Rough Valve Open
- User Text 02 Rough Valve Closed
- User Text 03 Diff Pump Run
- User Text 04 Diff Valve open
- User Text 05 Chamber Temp
- User Text 06 Start Program
- User Text 07 Start
- User Text 08 Pre Heat
- User Text 09 Stabilise
- User Text 10 Heat Ramp
- User Text 11 Annealing
- User Text 12 Cool Ramp
- User Text 13 Complete

The following examples show how to apply this to different types of parameter.

User Switch Example

This is an example of a parameter which has just two states.

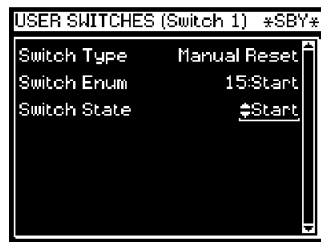

- User Text 10 Heat Ramp
- User Text 11 Annealing
- User Text 12 Cool Ramp
- User Text 13 Complete
- User Text 14 Furnace 1
- User Text 15 Start
- User Text 16 Stop



The procedure for configuring the above example is as follows

First set up the required user text as described in the previous section

Then:

In USER SWITCHES/Switch 1 page, (section User Switches)

- Set 'Switch Type' = Auto or Manual Reset
- Set 'Switch Enum' = User Text 15 'Start'

Each time the  or  button is pressed the 'Switch State' will toggle between 'Start' or 'Stop'

Programmer User Values Example

This example shows the configuration for Programmer User Value 1.

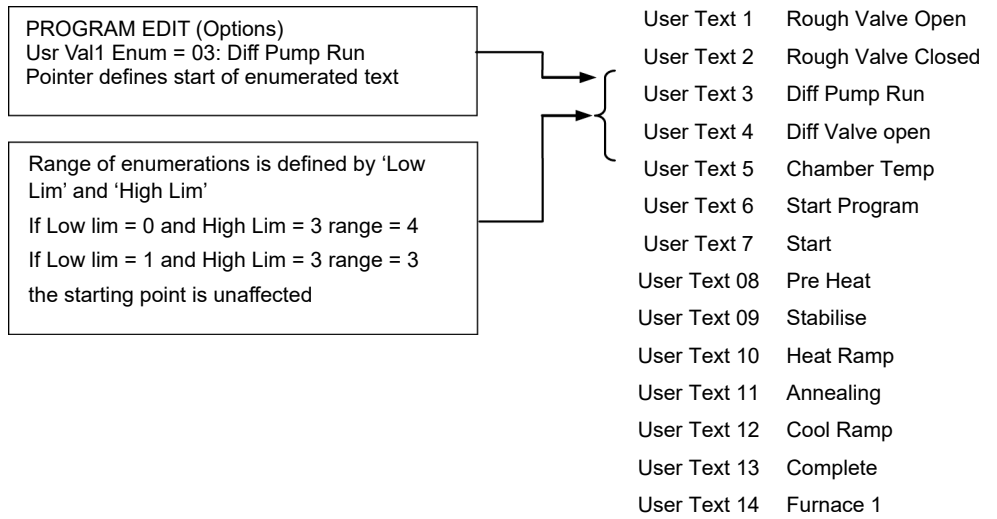

Enumerated User Value Example

This example enumerates User Value 1 with 1 decimal point resolution.

- In USER VALUES/User Val 1 page, (section User Values)
 - Set 'Resolution' = XXXX.X
 - Set 'Low Limit' = 0.0 (for example)
 - Set 'High Limit' = 1.0 (for example)
 - Set 'User Val Enum' = User Text 7 (for example)

The 'User 1 Value' will now switch between the next 10 user text values (ie Start to Complete) corresponding to each 0.1 change in the User Value 1.

- User Text 1 Rough Valve Open
- User Text 2 Rough Valve Closed
- User Text 3 Diff Pump Run
- User Text 4 Diff Valve open
- User Text 5 Chamber Temp
- User Text 6 Start Program
- User Text 7 Start
- User Text 08 Pre Heat
- User Text 09 Stabilise
- User Text 10 Heat Ramp
- User Text 11 Annealing
- User Text 12 Cool Ramp
- User Text 13 Baking
- User Text 14 Open Vent
- User Text 15 Stop Fan
- User Text 16 Complete

☺ When using Custom Enumerations it is important to remember that there is a maximum of 50 user strings available. The above technique, for example, uses 10 strings from the User Text library.

User Pages

What Are User Pages

User pages allow you to place a pre-determined number of parameters onto a set of semi-custom screens. Each of the available screens has a pre-determined structure allowing specific parameter types to be placed directly into empty slots. There are eight screen styles of this type and up to eight user pages may be defined using any combination of these styles.

Each screen may be accessed under the LOOP button or from the Page Menu.

With the exception of the Parameter List Style page, a scroll list of up to 10 parameters may also be configured. These parameters always appear at the bottom of the screen and they are the only parameters which can be made alterable depending upon the access level setting of each parameter.

User Page Styles

As stated above there are eight page styles. These are:

1. Single Loop
2. Dual Loop
3. Triple Loop – style 1
4. Triple Loop – style 2
5. Status Grid
6. Bar Graph
7. Blank (this could be used, for example, in a photographic development area)
8. Parameter List

Each of these screens defines a fixed format on which you can place parameters suited to your particular application. The position of each custom parameter is dictated by a number, as shown on each of the screen views which follow. To define the parameter choose the number using '**Custom Param**' in the USER PAGES list followed by '**Custom Ad**'.

'Custom' is used to refer to parameters which are placed on the User Page.

Similarly, 'Promote' is used to refer to parameters which are promoted to the list at the bottom of each screen.

If the selected parameter is a bar graph parameter, two additional parameters '**Custom GraphHi**' and '**Custom GraphLo**' will be available.

Single Loop User Page

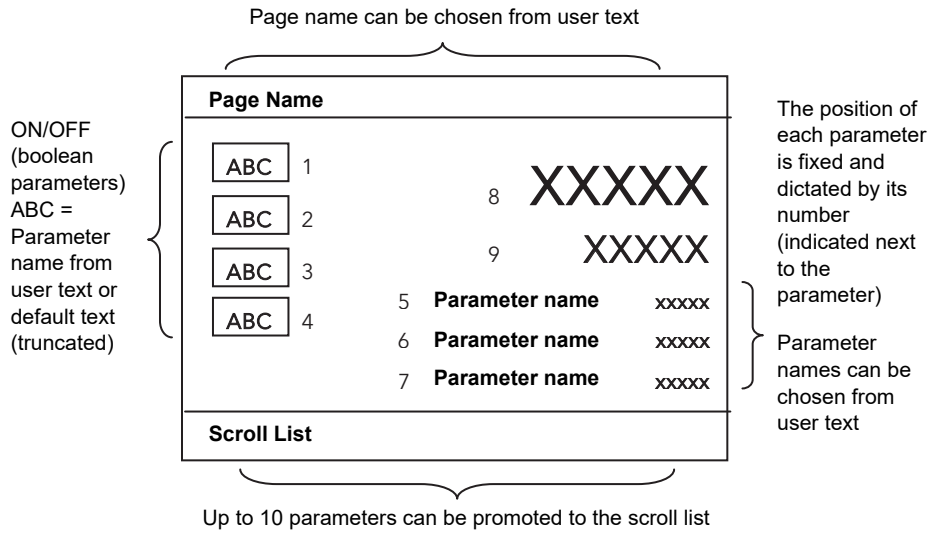

Figure 92 Single Loop User Page

Dual Loop User Page

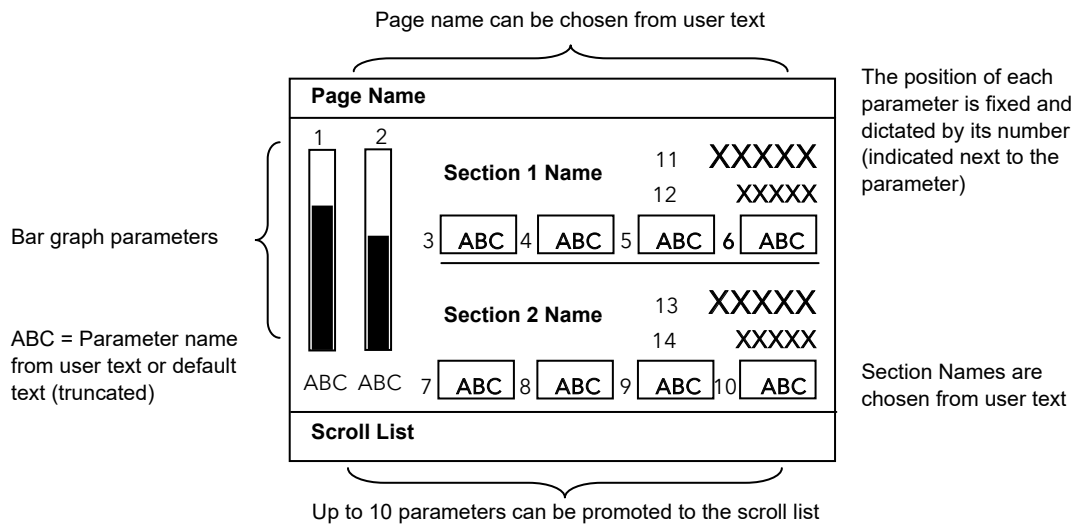

Figure 93 Dual Loop User Page

Triple Loop User Page – Style 1

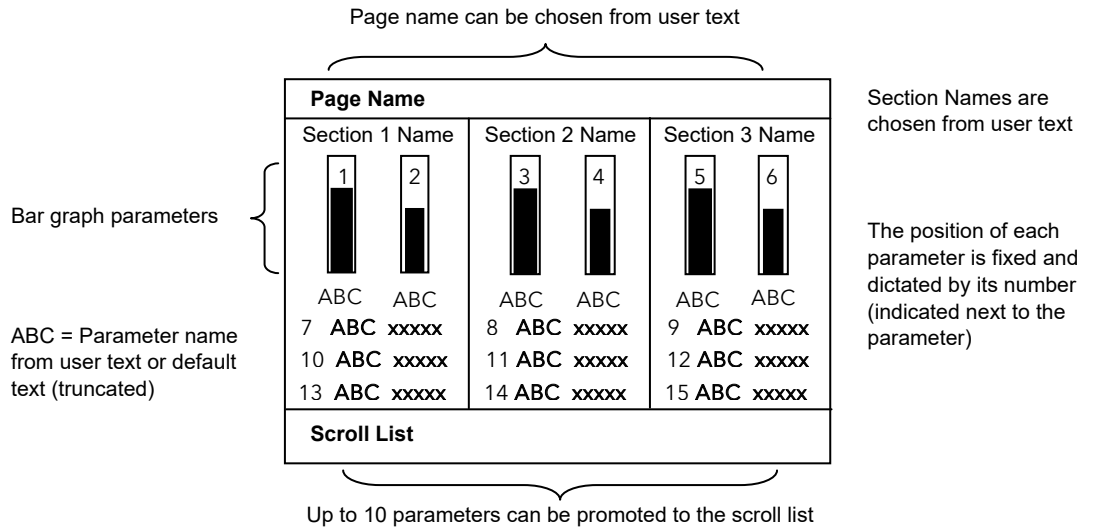

Figure 94 Triple Loop User Page 1

Triple Loop User Page – Style 2

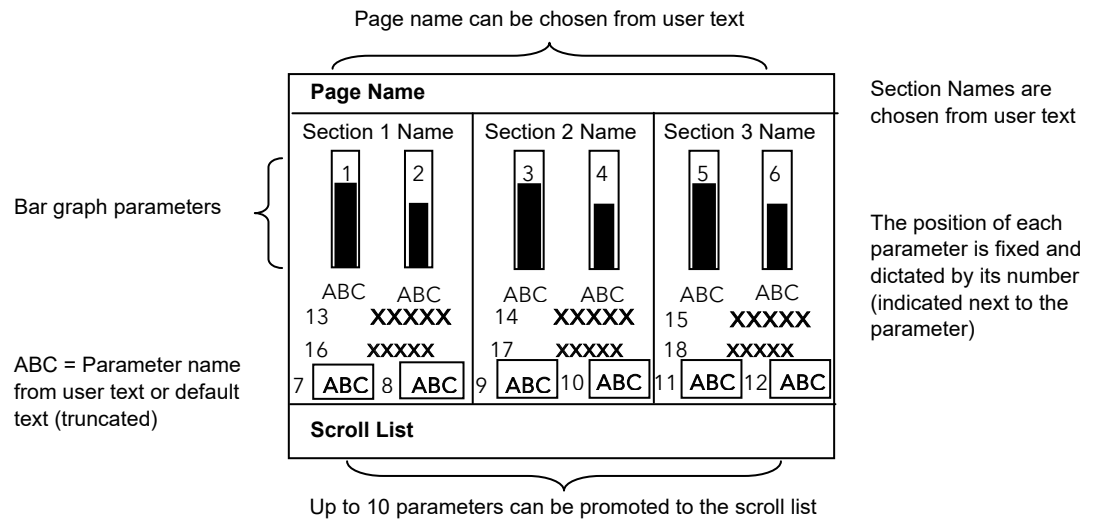

Figure 95 Triple Loop User Page 2

Status Grid User Page

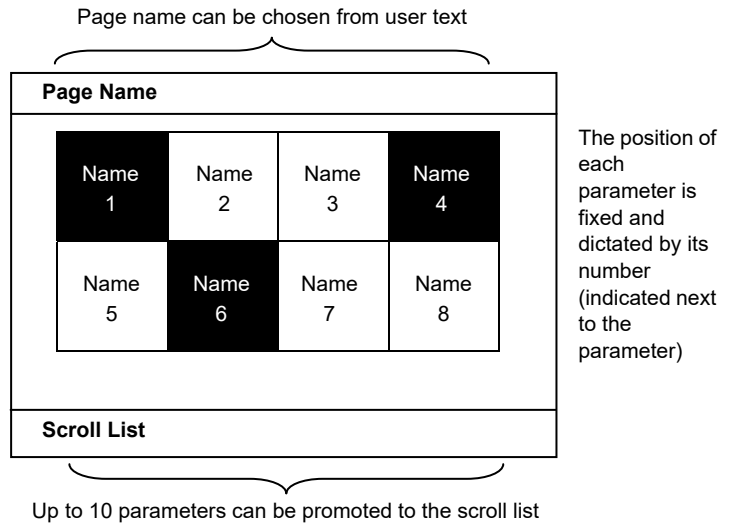

Figure 96 Status Grid User Page

The position of the parameters depends upon the number of configured parameters and the status indicators are resized as indicated below. This allows the display of more characters in each status indicator. Up to 12 may be configured in this page.

Name 1	Name 2	Name 1	Name 2	Name 3
Name 3	Name 4	Name 4	Name 5	Name 6

Name 1	Name 2	Name 3	Name 4
Name 5	Name 6	Name 7	Name 8
Name 9	Name 10	Name 11	Name 12

Figure 97 Status Indicators for 4, 6 and 12 Parameters

Bar Graph

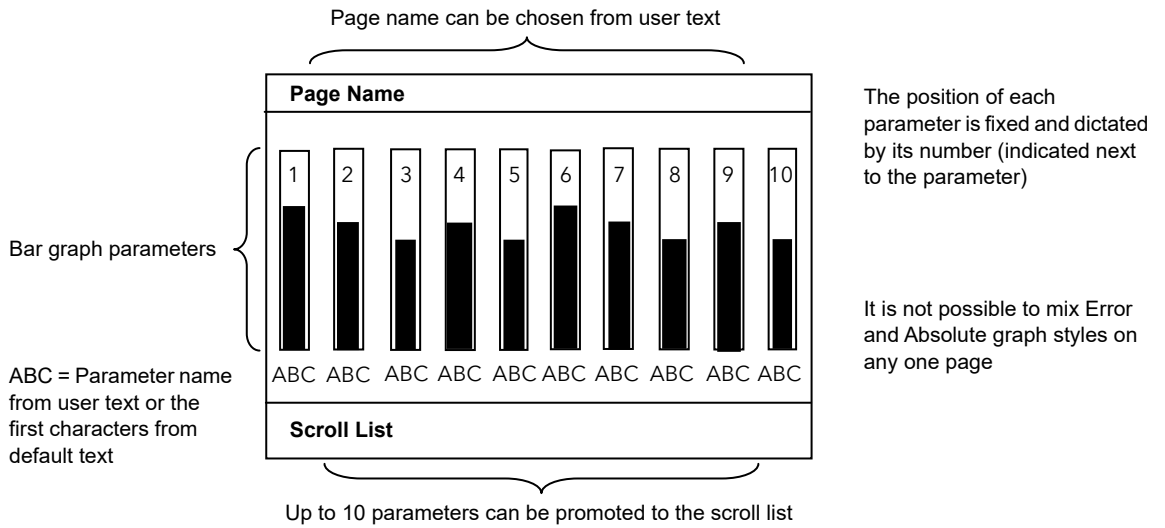

Figure 98 Bar Graph User Page

Similar to the Status Grid style and the Status Indicators, the position and width of the bar graph will depend on the number of configured parameters. This allows more characters to be printed below each graph. The maximum number of graphs is ten.

Parameter List Style

In addition to the six styles listed above, parameters can be listed in exactly the same way as the Summary Page listed in section Instrument Summary Page. In effect this allows a further eight summary pages to be defined if required. The parameters appear in the order in which they are defined.

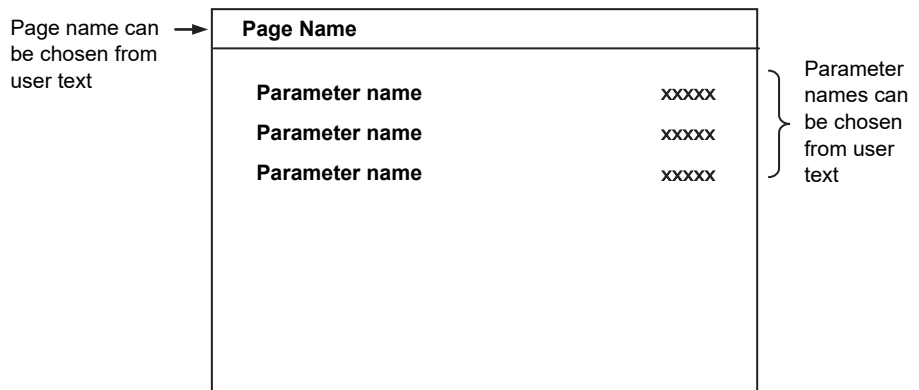



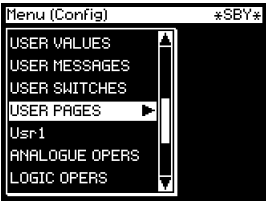



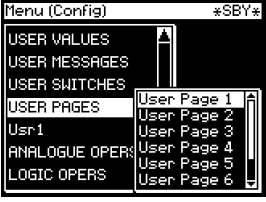



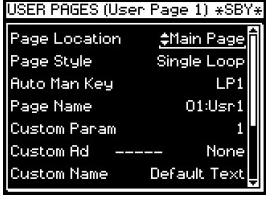



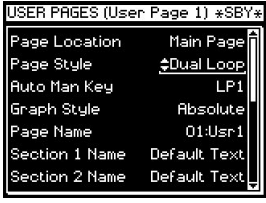



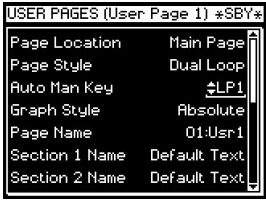



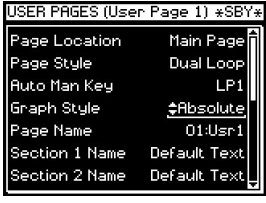

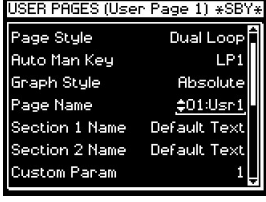





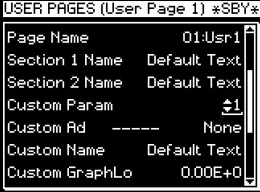



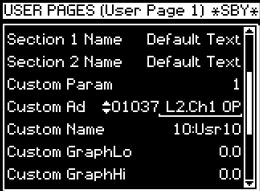



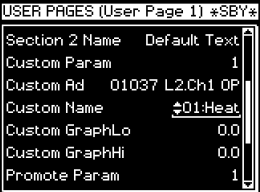



Figure 99 Parameter List Style

To Configure a User Page

Configuration of the Parameter List style is identical to that described in section Instrument Summary Page.

Configuration of other styles is the same, in principle, for all other pages. The example below configures a Dual Loop style.

Do This	This Is The Display You Should See	Additional Notes
<p>1. From any display press  as many times as necessary to access the page header menu</p> <p>2. Press  or  to select 'USER PAGES'</p>		<p>'Usr1' is the name which has been given to a User Screen, see paragraph 12. 'Usr1' will normally be replaced by user defined text.</p>
<p>3. Press  to display sub-headers</p> <p>4. Press  or  to select the User Page to be configured</p>		
<p>5. Press  to show the list of parameters in the User Page selected</p> <p>6. Press  again to choose the parameter</p> <p>7. Press  or  to select 'Main Page', 'Loop Summary' or 'None'</p>		<p>'Page Location' defines how to access the page.</p> <p>If 'Main Page' is selected the User Page will appear in the main menu following 'USER PAGES'. It is available in all access levels.</p> <p>If 'Loop Summary' is selected the User Page will be found by pressing the LOOP button in Operator access level</p> <p>'None' will hide the page until it is required</p>
<p>8. Press  to select 'Page Style'</p> <p>9. Press  or  to select 'Dual Loop'</p>		<p>Choices are;</p> <ul style="list-style-type: none"> Parameter List Single Loop Dual Loop Triple Loop 1 Triple Loop 2 Status Grid Bar Graph Blank Page
<p>10. Press  to select 'Auto Man Key'</p> <p>11. Press  or  to choose the loop to be put into auto/manual mode</p>		<p>This parameter is described in more detail in section Auto Manual Operation From a User Page.</p>
<p>12. Press  to select 'Graph Style'</p> <p>13. Press  or  to choose 'Absolute' or 'Error'</p>		<p>'Absolute' defines a bar graph which grows from zero at the base.</p> <p>'Error' defines a bar graph which grows from zero at the centre. It is scaled by Graph Hi and Graph Lo so that the origin can be offset from the centre</p>
<p>14. Press  to select 'Page Name'</p> <p>15. Press  to choose the heading which will appear in the top banner of the user page</p>		<p>'The page name can be chosen from 'User Text' (section Instrument User Text Page)</p> <p>If 'Default Text' is chosen the page heading will be 'User Page 1 (to 8)'</p> <p>The following two parameters 'Section 1 (or 2) Name' are selected in the same way and define the text which appears under section 1 (or 2) names in the Dual Loop Page view</p>

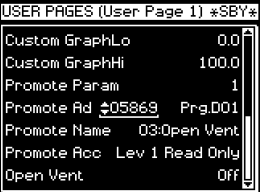
Do This	This Is The Display You Should See	Additional Notes
16. Press  to select 'Custom Param' 17. Press  or  to select required the parameter number		The number of the custom parameter should correspond to the position shown in the User Page views, e.g. 1 to 12
18. Press  to select 'Custom Ad' 19. Press  or  select the parameter which you wish to display in the nominated position		The parameter can be chosen by its Modbus address or by selecting the parameter by its name from the list of commonly used parameters given in Appendix D
20. Press  to select 'Custom Name' 21. Press  or  select from User Text the required name of the parameter		The custom text for 01 as defined in section Instrument User Text Page is 'Heat'. The number of characters which will be displayed on the user page will be truncated. The following two parameters set the range of the graph. These are set using the same procedure as above
Up to ten parameters can be promoted to the bottom section of the user page. These parameters can be scrolled and adjusted in the User Page view. The remaining parameters in the User Page configuration list set up these parameters.		
22. Press  to select 'Promote Param' 23. Press  or  to choose required the parameter number		Up to ten parameters may be promoted. The order in which they appear in the User Page is determined by the order in which they are selected here.

The remaining parameters are selected and chosen in exactly the same way as those already described. The display above shows:

- The first parameter (1) in the user page list is Programmer Event Output (DO1)
- The name of this parameter is chosen from User Text (03) which has been given the name 'Open Vent'
- The access level of this parameter is read only
- The state (Off) or value of the parameter is shown

To Display the User Page View

Using the above example, the User Page will be found in both configuration and operator levels in the main menu under its name (Usr1). If the parameter 'Page Location' = 'Loop Summary' the user page is only available in operator level by pressing the Loop button. Further parameters can be added, by selecting 'Custom Param' 2 to 14 and its modbus address, so that it appears as shown in the page view at the beginning of this chapter.

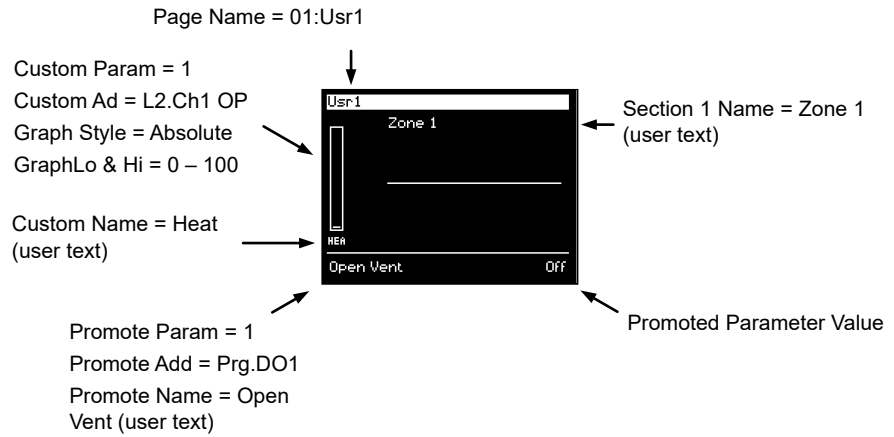

Figure 100 Dual Loop User Page Example

Auto Manual Operation From a User Page

From software version 6 onwards an additional parameter called 'Auto Man Key' has been made available on all styles of User Page. This means that auto/manual operation can be associated with the user page being displayed. For example, if on 'User Page 1' 'Auto Man Key' = 'LP1', then in operation levels loop 1 can be put into auto or manual mode from User Page 1. Similarly User Page 2 could have 'Auto Man Key' = 'LP2' so that loop 2 can be put into auto or manual mode when User Page 2 is being displayed.

User Page Parameter Tables

The parameter tables are listed for each type of User Page.

Single Loop

Table 68: This page allows you to configure a single loop user page			USER PAGES (User Page 1 to 8)	
Parameter Name	Parameter Description	Value	Default	Access Level
Page Location	Defines where the page is located	None Main Page Loop Summary	None	Conf
Page Style	Defines the style of the page	Parameter List Single Loop Dual loop Triple Loop 1 Triple Loop 2 Status Grid Bar Graph Blank Page		Conf
Auto Man Key	Auto manual button is associated with this user page	None LP1 LP2 LP3	None	Conf
Page Name	Defines the name which appears in the header at the top of the page	Default Text 01:User Text to 100:User Text	Default Text	Conf
Custom Param	Parameter number	1 to 9		Conf
Custom Ad	Parameter address	Modbus Address		Conf
Custom Name	Parameter name from user text	Default Text 01:User Text to 100:User Text	Default Text	Conf
Promote Param	Promote parameter number	1 to 10		Conf
Promote Add	Promote parameter address	Modbus Address		Conf
Promote Name	Promote parameter name from user text	Default Text 01:User Text to 100:User Text	Default Text	Conf
Promote Acc	Access level of the promoted parameter	Lev 1 Read Only Lev 1 Alterable Lev 2 Read Only Lev 2 Alterable		Conf
Promote Value	Promoted parameter value	Only appears if a parameter is promoted		

Dual Loop

Table 69: This page allows you to configure a dual loop user page			USER PAGES (User Page 1 to 8)	
Parameter Name	Parameter Description	Value	Default	Access Level
Page Location	Defines where the page is located	None Main Page Loop Summary		Conf
Page Style	Defines the style of the page	Parameter List Single Loop Dual loop Triple Loop 1 Triple Loop 2 Status Grid Bar Graph Blank Page		Conf
Auto Man Key	Auto manual button is associated with this user page	None LP1 LP2 LP3	None	Conf
Graph Style	Grows from bottom up Grows from centre	Absolute Error		Conf
Page Name	Defines the name which appears in the header at the top of the page	Default Text 01 to 100:User Text	Default Text	Conf
Section 1 Name	Defines the text which appears in the top section	Default Text 01:User Text to 100: User Text	Default Text	Conf
Section 2 Name	Defines the text in the lower section		Default Text	Conf
Custom Param	Parameter number	1 to 14		Conf
Custom Ad	Parameter address	Modbus Address		Conf
Custom Name	Parameter name from user text	Default Text 01 to 100:User Text	Default Text	Conf
Custom GraphLo	Graph low point	-999.9 to 9999.9		Conf
Custom GraphHi	Graph high point	-999.9 to 9999.9		Conf
Promote Param	Promote parameter number	1 to 10		Conf
Promote Add	Promote parameter address	Modbus Address		Conf
Promote Name	Promote parameter name from user text	Default Text 01 to 100:User Text	Default Text	Conf
Promote Acc	Access level of the promoted parameter	Lev 1 Read Only Lev 1 Alterable Lev 2 Read Only Lev 2 Alterable		Conf
Promote Value	Promoted parameter value	Only appears if a parameter is promoted		

Triple Loop 1 and 2

Table 70: This page allows you to configure a triple loop 1 and 2 user page			USER PAGES (User Page 1 to 8)	
Parameter Name	Parameter Description	Value	Default	Access Level
Page Location	Defines where the page is located	None Main Page Loop Summary		Conf
Page Style	Defines the style of the page	Parameter List Single Loop Dual loop Triple Loop 1 Triple Loop 2 Status Grid Bar Graph Blank Page		Conf
Auto Man Key	To associate the Auto manual button with this page	None LP1 LP2 LP3	None	Conf
Graph Style	Grows from bottom up Grows from centre	Absolute Error		Conf
Page Name	Defines the name which appears in the header at the top of the page	Default Text 01 to 100:User Text	Default Text	Conf
Section 1 Name	Defines the text which appears in the left section	Default Text 01:User Text to 100: User Text		Conf
Section 2 Name	Defines the text in the mid section		Default Text	Conf
Section 3 Name	Defines the text in the right section		Default Text	Conf
Custom Param	Parameter number	1 to 15 (or 18)		Conf
Custom Ad	Parameter address	Modbus Address		Conf
Custom Name	Parameter name from user text	Default Text 01 to 100:User T	Default Text	Conf
Custom GraphLo	Graph low point	-999.9 to 9999.9		Conf
Custom GraphHi	Graph high point	-999.9 to 9999.9		Conf
Promote Param	Promote parameter number	1 to 10		Conf
Promote Add	Promote parameter address	Modbus Address		Conf
Promote Name	Promote parameter name from user text	Default Text 01 to 100:User T	Default Text	Conf
Promote Acc	Access level of the promoted parameter	Lev 1 Read Only Lev 1 Alterable Lev 2 Read Only Lev 2 Alterable		Conf
Promote Value	Promoted parameter value	Only appears if a parameter is promoted		

Status Grid

Table 71: This page allows you to configure a status grid user page			USER PAGES (User Page 1 to 8)	
Parameter Name	Parameter Description	Value	Default	Access Level
Page Location	Defines where the page is located	None Main Page Loop Summary		Conf
Page Style	Defines the style of the page	Parameter List Single Loop Dual loop Triple Loop 1 Triple Loop 2 Status Grid Bar Graph Blank Page		Conf
Auto Man Key	Auto manual button is associated with this user page	None LP1 LP2 LP3	None	Conf
Page Name	Defines the name which appears in the header at the top of the page	Default Text 01 to 100:User Text	Default Text	Conf
Custom Param	Parameter number	1 to 12		Conf
Custom Ad	Parameter address	Modbus Address		Conf
Custom Name	Parameter name from user text	Default Text 01 to 100:User T	Default Text	Conf
Promote Param	Promote parameter number	1 to 10		Conf
Promote Add	Promote parameter address	Modbus Address		Conf
Promote Name	Promote parameter name from user text	Default Text 01 to 100:User T	Default Text	Conf
Promote Acc	Access level of the promoted parameter	Lev 1 Read Only Lev 1 Alterable Lev 2 Read Only Lev 2 Alterable		Conf
Promote Value	Promoted parameter value	Only appears if a parameter is promoted		

Bar Graph

Table 72: This page allows you to configure a bar graph user page			USER PAGES (User Page 1 to 8)	
Parameter Name	Parameter Description	Value	Default	Access Level
Page Location	Defines where the page is located	None Main Page Loop Summary		Conf
Page Style	Defines the style of the page	Parameter List Single Loop Dual loop Triple Loop 1 Triple Loop 2 Status Grid Bar Graph Blank Page		Conf
Auto Man Key	Auto manual button is associated with this user page	None LP1 LP2 LP3	None	Conf
Graph Style	Grows from bottom up Grows from centre	Absolute Error		Conf
Page Name	Defines the name which appears in the header at the top of the page	Default Text 01 to 100:User Text	Default Text	Conf
Custom Param	Parameter number	1 to 10		Conf
Custom Ad	Parameter address	Modbus Address		Conf
Custom Name	Parameter name from user text	Default Text 01 to 100:User Text	Default Text	Conf
Custom GraphLo	Graph low point	-999.9 to 9999.9		Conf
Custom GraphHi	Graph high point	-999.9 to 9999.9		Conf
Promote Param	Promote parameter number	1 to 10		Conf
Promote Add	Promote parameter address	Modbus Address		Conf
Promote Name	Promote parameter name from user text	Default Text 01 to 100:User Text	Default Text	Conf
Promote Acc	Access level of the promoted parameter	Lev 1 Read Only Lev 1 Alterable Lev 2 Read Only Lev 2 Alterable	None	Conf
Promote Value	Promoted parameter value	Only appears if a parameter is promoted		

Parameter List

Table 73: This page allows you to configure a parameter list user page			USER PAGES (User Page 1 to 8)	
Parameter Name	Parameter Description	Value	Default	Access Level
Page Location	Defines where the page is located	None Main Page Loop Summary		Conf
Page Style	Defines the style of the page	Parameter List Single Loop Dual loop Triple Loop 1 Triple Loop 2 Status Grid Bar Graph Blank Page		Conf
Auto Man Key	Auto manual button is associated with this user page	None LP1 LP2 LP3	None	Conf
Page Name	Defines the name which appears in the header at the top of the page	Default Text 01 to 100:User Text	Default Text	Conf
Promote Param	Promote parameter number	1 to 10		Conf
Promote Add	Promote parameter address	Modbus Address		Conf
Promote Name	Promote parameter name from user text	Default Text 01 to 50:User Text	Default Text	Conf
Promote Acc	Access level of the promoted parameter	Lev 1 Read Only Lev 1 Alterable Lev 2 Read Only Lev 2 Alterable		Conf
Promote Value	Promoted parameter value	Only appears if a parameter is promoted		

Blank Page

The blank page is available for those applications which require the controller to operate but with the display switched off. A typical application may be for use in a photographic dark room. The Parameter 'Auto Man Key' can still be associated with the Blank Page.

Remember, however, to ensure that the parameter 'Home Timeout' (INSTRUMENT/Display Page) is set to 'None'.

Analogue And Multiple Operators

What are Analogue Operators?

Analogue Operators allow the controller to perform mathematical operations on two input values. These values can be sourced from any available parameter including Analogue Values, User Values and Digital Values. Each input value can be scaled using a multiplying factor or scalar as shown in Figure 101.

The parameters to use, the type of calculation to be performed and the acceptable limits of the calculation are determined in Configuration level. In access level 3 you can change values of each of the scalars. In Access levels 2 & 3, provided the Analogue Operators page has been promoted, the input values and the result of the calculation can be read.

The Analogue and Multiple Operators pages are only available if the Toolkit Functions options have been ordered and Analogue and Logic Operators have been enabled in configuration level as described in section To Configure Controller Options.

Up to 32 separate operations can be performed and a separate page header is provided for each one.

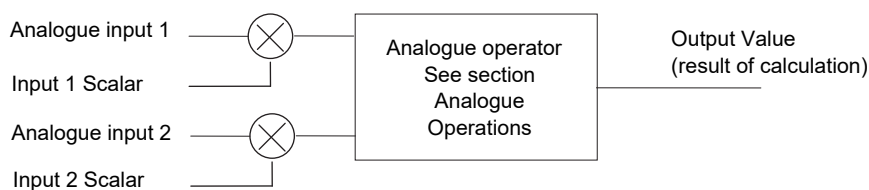





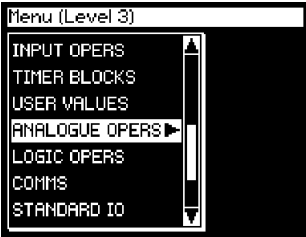









Figure 101 Analogue Operators

Analogue Operations

The following operations can be performed:

Off	The selected analogue operator is turned off
Add	The output result is the addition of Input 1 and Input 2
Subtract	The output result is the difference Input 1 and Input 2 where Input 1 > Input 2
Multiply	The output result is the multiplication of Input 1 and Input 2
Divide	The output result is Input 1 divided by Input 2
Absolute Difference	The output result is the absolute difference between Input 1 and 2
Select Max	The output result is the maximum of Input 1 and Input 2
Select Min	The output result is the minimum of Input 1 and Input 2
Hot Swap	Input 1 appears at the output provided input 1 is 'good'. If input 1 is 'bad' then input 2 value will appear at the output. An example of a bad input occurs during a sensor break condition.
Sample and Hold	Normally input 1 will be an analogue value and input B will be digital. The output tracks input 1 when input 2 = 1 (Sample). The output will remain at the current value when input 2 = 0 (Hold). Input 2 can be an analogue value and must change from 0 to 100% to provide a sample and hold at the output.
Power	The output is the value at input 1 raised to the power of the value at input 2. I.e. $input\ 1^{input\ 2}$
Square Root	The output result is the square root of Input 1. Input 2 has no effect.
Log	The output is the logarithm (base 10) of Input 1. Input 2 has no effect
Ln	The output is the logarithm (base n) of Input 1. Input 2 has no effect
Exp	The output result is the exponential of Input 1 ($e^{input\ 1}$). Input 2 has no effect
10x	The output result is 10 raised to the power of Input 1, ($10^{input\ 1}$). Input 2 has no effect
Select Logic 1 up to Select Logic 32	<p>Logic Operator 1 to 32 is used to control which Analogue Input is switched to the output of the Analogue Operator. If the output from the logic operator is true input 1 is switched through to the output. If false input 2 is switched through to the output. See example below:</p>

To Configure Analogue Operators

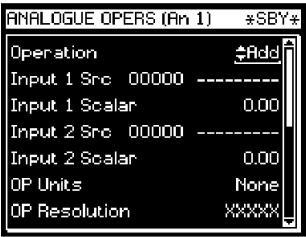
Do This	This Is The Display You Should See	Additional Notes
1. From any display press  as many times as necessary to access the page header menu 2. Press  or  to select 'ANALOGUE OPERS'		The USER SWITCHES page is only available if Enabled as described in section To Configure Controller Options
3. Press  to show Sub-headers 4. Press  or  to select 'An 1 (to 32)'		
5. Press  to show the parameter list 6. Press  or  to scroll to the required parameter 7. Press  to edit the parameter list 8. Press  or  to change the value or state		The first parameter is 'Operation'. The choices are: Off, Add, Subtract, Multiply, Divide, Absolute Difference, Select Max, Select Min, Hot Swap, Sample Hold, Square Root, Log, Ln, Exp, 10x, Select Logic 1 to Select Logic 32.

Remaining parameters in the Analogue Operators list are accessed and adjusted in the same way.

The list of parameters available is shown in the following table:

Analogue Operator Parameters

Table 74:	This page allows you to configure Analogue Operators 1 to 32		ANALOGUE OPERS (Analogue 1 Page)	
Parameter Name	Parameter Description	Value	Default	Access Level
Operation	The operation to be performed	See 16.1.1	Off	L1
Input 1 Src	Input 1 source	Modbus address		Conf
Input 1 Scalar	Input 1 scalar	Range depends on Input 1 Src		L3
Input 2 Src	Input 2 source	Modbus address		Conf
Input 2 Scalar	Input 2 scalar	Range depends on Input 2 Src		L3
OP Units	Output units	See Appendix D.2.		Conf
OP Resolution	Output resolution	XXXXX, XXXX.X, XXX.XX, XX.XXX		Conf
Low Limit	Output low limit	Display min to display max		Conf
High Limit	Output high limit	Display min to display max		Conf
Default Enable	Enable fall back	Clip (Bad) Fallback (Bad) Clip (Good) Fallback (Good)		Conf
Default OP	Fall back value	Display min to display max		Conf
Input 1 Value	Input 1 Value	Display min to display max		L1
Input 2 Value	Input 2 Value	Display min to display max		L1
Output Value	Output Value	Display min to display max		L1
Status	Status	Good/Bad		L1

The above table is repeated for Analogue Operators 2 to 24.

Multiple Operators

The multiple input operator block performs analogue operations on up to six inputs. It can be used to find the average, maximum value, minimum value or summation of the inputs. The block will output either the operation result (which may be clipped) or a user-defined Default value depending upon the number and status of the wired inputs and whether they are within a user specified range.

The Casc Numlps Src is a wire that indicates to the block the number of inputs cascaded from a previous block (this is required for a valid average calculation when in cascade). If this input is wired it is assumed that the block is in cascade and that input 1 is used as the cascade input. If the block is in cascade and the status of input1 wire is bad the value given by the Casc Numlps Src wire will not be used in any calculations or added to the Num lps output.

The select operation input, the Casc Numlps input and the six data inputs are wireable.

The block outputs the result of the operation, the number of inputs used in the calculation and status.

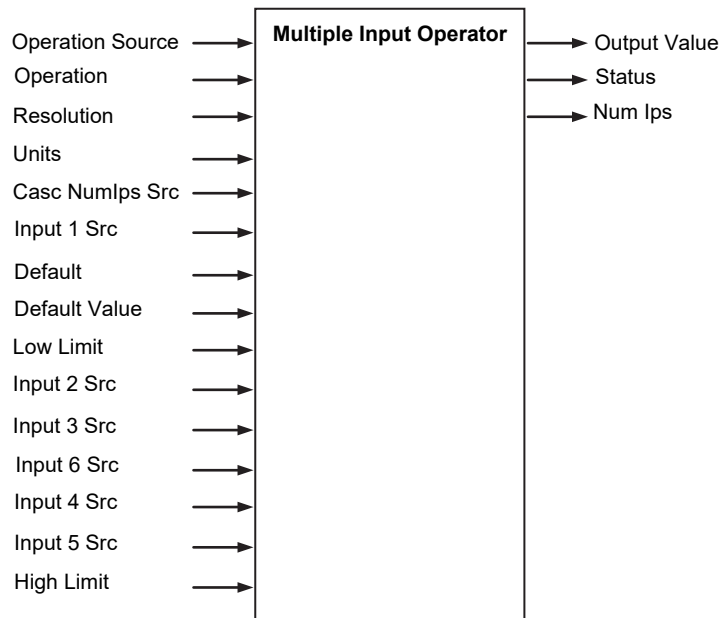

Figure 102 Multiple Input Operator Block

Cascading Multiple Input Blocks

If the block is to be used to find an average of more than 6 inputs it can be cascaded to allow this to happen. The correct way to cascade blocks for average is to perform sum operations and then cascade into an Average block at the end of the chain.

The diagram below indicates how to implement an average of more than six values.

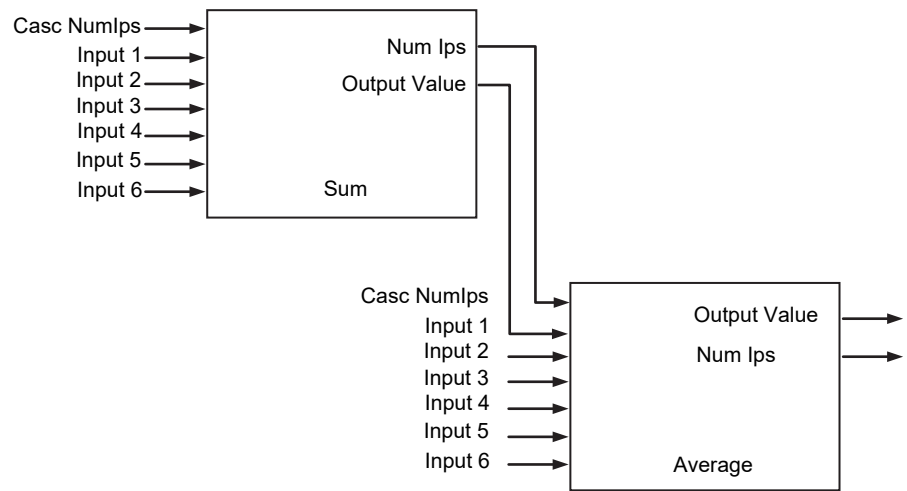





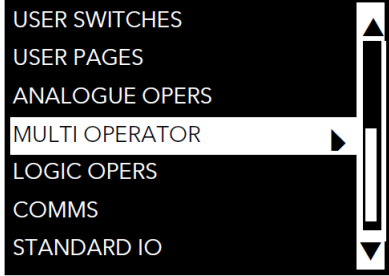



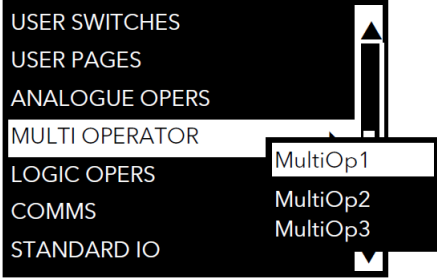





Figure 103 Cascading More Than Six Inputs

To average more than eleven inputs two sum blocks can be cascaded into each other and then into an average block.

To Enable Multi Operators

In INSTRUMENT OPTIONS Page, enable 'An/Logic Opers'.

To Locate Multi Operator Parameters

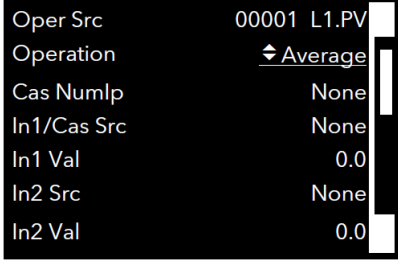
Do This	This Is The Display You Should See	Additional Notes
<p>1. From any display press  as many times as necessary to access the page header menu</p> <p>2. Press  or  to select 'USER SWITCHES'</p>		<p>The actual view may vary depending on options enabled</p>
<p>3. Press  to display sub-headers</p> <p>4. Press  or  to select the 'MultiOp' block required</p>		
<p>5. Press  to display parameters</p> <p>6. Press  or  to scroll to the required parameter</p> <p>7. Press  to edit the parameter</p> <p>8. Press  or  to change its value</p>		

The following table lists further parameters in this page:

Multi Operator MultiOp1 (to 3) Page

Table 75:	These parameters allow you to configure the selected multi operator Press < to select each parameter		MULTI OPERATOR MultiOp1 (to 3) Page	
Parameter Name	Parameter Description	Value	Default	Access Level
Oper Src	Source for Operation	Modbus address	----- None	Conf
Operation	Selected operation The output will be the average of up to six inputs The output will be the sum of up to six inputs The output will be the maximum of up to six inputs The output will be the minimum of up to six inputs	None Average Sum Max Min	None	Conf R/O L1
Casc Numlp	Address of the Num Ips parameter in the previous block of a cascade. If not wired, not in a cascade.	Modbus address	----- None	Conf
In1/Cas Src	Source for cascade input. If not in a cascade, Source for input 1	Modbus address	----- None	Conf
In1 Val	Value of input 1		----- None	
In2 Src	Source for input 2	Modbus address	----- None	Conf

Table 75: These parameters allow you to configure the selected multi operator Press < to select each parameter		MULTI OPERATOR MultiOp1 (to 3) Page		
Parameter Name	Parameter Description	Value	Default	Access Level
In2 Val	Value of input 2			
In3 Src	Source for input 3	Modbus address	----- None	Conf
In3 Val	Value of input 3			
In4 Src	Source for input 4	Modbus address	----- None	Conf
In4 Val	Value of input 4			
In5 Src	Source for input 5	Modbus address	----- None	Conf
In5 Val	Value of input 5			
In6 Src	Source for input 6	Modbus address	----- None	Conf
In6 Val	Value of input 6			
OP Units	Units	See note 1	None	Conf
OP Resolution	Resolution	0 to 4 decimal places or SCI (scientific)	XXXXXX	Conf
Low Limit	Output Low Limit			Conf
High Limit	Output High Limit			Conf
Default	To define the fallback condition See section Use of Default	Clip (Bad) Fallback (Bad) Clip (Good) Fallback (Good)	Clip (Bad)	Conf
Default OP	Fallback Value			Conf
Num IPs	Number of inputs used in the calculation			L3
Output value	Result of operation			L3
Status	Determined by Default type.	Good Bad		L3

Note: Units None, °C/°F/K, V, mV, A, mA, PH, mmHg, psi, Bar, mBar, %RH, %, mmWG, inWG, inWW, Ohms, PSIG, %O2, PPM, %CO2, %CP, %/sec, °C/°F/K (rel), Custom 1, Custom 2, Custom 3, Custom 4, Custom 5, Custom 6, mBar/Pa/Torr, sec, min, hrs, HH:MM:SS.S, HHH:MM:SS, °C, °F,K,/sec,/min,/hr

The above table of parameters is repeated for MultiOp2 and 3.

Use of Default

The table below shows how the default type affects the output result:

	Clip (Bad)		Fallback (Bad)		Clip (Good)		Fallback (Good)	
	In range	Out of range	In range	Out of range	In range	Out of range	In range	Out of range
No inputs wired	Output = Default value Status = Bad				Output = Default value Status = Good			
One or more inputs OK	Output = Operation Status = Good	Output = Clip Status = Bad	Output = Operation Status = Good	Output = Default Status = Bad	Output = Operation Status = Good	Output = Clip Status = Good	Output = Operation Status = Good	Output = Default Status = Bad
All wired inputs bad	Output = Default value Status = Bad				Output = Default value Status = Good			

Note: The default value must be within the blocks limits or it will be clipped to those limits.

Logic Operators

Logic Operators allow the controller to perform logical calculations on two input values. These values can be sourced from any available parameter including Analogue Values, User Values and Digital Values.

The parameters to use, the type of calculation to be performed, input value inversion and 'fallback' value are determined in Configuration level. In levels 1 to 3 you can view the values of each input and read the result of the calculation.

The Logic Operators and Patch Wiring pages are only available if the Toolkit Functions options have been ordered and Analogue and Logic Operators have been enabled as described in To Configure Controller Options.

Up to 32 separate calculations can be performed and a separate page header is provided for each one.

Logic Operations

The following calculations can be performed:

Off	The selected logic operator is turned off
AND	The output result is ON when both Input 1 and Input 2 are ON
OR	The output result is ON when either Input 1 or Input 2 is ON
XOR	Exclusive OR. The output result is true when one and only one input is ON. If both inputs are ON the output is OFF.
Latch	The output is ON when input 1 turns ON. The output remains ON when input 1 turns OFF. The output is reset to OFF by turning input 2 ON.
Equal	The output result is ON when Input 1 = Input 2
Greater	The output result is ON when Input 1 > Input 2
Less than	The output result is ON when Input 1 < Input 2
Greater or Equal	The output result is ON when Input 1 ≥ Input 2
Less or Equal	The output result is ON when Input 1 ≤ Input 2

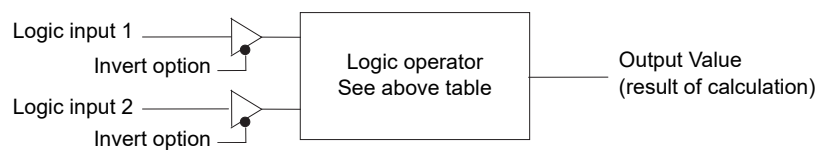



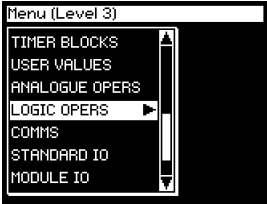



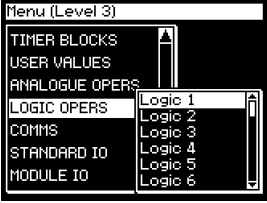





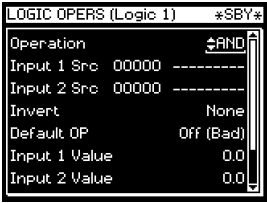

Figure 104 Logic Operators

To Configure Logic Operators

Do This	This Is The Display You Should See	Additional Notes
1. From any display press  as many times as necessary to access the page header menu 2. Press  or  to select 'LOGIC OPERS'		
3. Press  to show Sub-headers 4. Press  or  to select 'Logic 1 (to 32)'		
5. Press  to show the parameter list 6. Press  or  to scroll to the required parameter 7. Press  to select the parameter 8. Press  or  to change the value or state		The first parameter is 'Operation'. The choices are: Off, AND, OR, XOR, Latch, Equal, Not Equal, Greater, Less Than, Great or Equal, Less or Equal.

Remaining parameters in the Analogue Operators list are accessed and adjusted in the same way.

The list of parameters available is shown in the following table ↓↓

Logic Operator Parameters

Table 76: This page allows you to configure Logic Operators 1 to 31			LOGIC OPERS (Logic 1 Page)	
Parameter Name	Parameter Description	Value	Default	Access Level
Operation	The logical operation to be performed	See section Logic Operations	Off	L1
Input 1 Src	Input 1 source	Modbus address		Conf
Input 2 Src	Input 2 source	Modbus address		Conf
Invert	Invert inputs	None Invert Input 1 Invert Input 2 Invert Both		Conf
Default OP	Fall back value (Does not appear if 'Operation' = Off)	0 or 1		Conf
Input 1 Value	Input 1 Value	Off On		L3
Input 2 Value	Input 2 Value	Off On		L3
Output Value	Output Value	Off On Enumerated if 'OP Enum' = User defined text		L3
Status	Status	Good Bad		L3
OP Enum	User string for the first enumeration of the Output Value	Not Enumerated or choose from User Text	Not Enumerated	Conf

The above table is repeated for Logic Operators 2 to 31.

Patch Wiring

Patch wiring consists of blocks that allow the user to wire from any parameter to another. Each block consists of a 'Source', 'Destination' and 'Status' element. Each wire status indicates the success / failure of the connection (successful writing of the value or not – failure could be due to the source being outside of the limits of the destination or a type incompatibility etc).

The 2700 controller includes 32 of these wires.

The parameters for the point to point wiring are available for viewing / editing only when the unit is in configuration level access mode, in all other access levels the parameters are only viewable and not editable.

An example of where patch wiring is useful is to be able to wire to a parameter which cannot otherwise be wired – a User Value to an output for example:

for wire 1...

Wire 1 Src 09225 Uval2.val

Wire 1 Dest 00004 L1.Wkg Op

Wire 1 Status Ok

Patch Wiring Parameters

Table 77: This page allows you to wire from any parameter to another			PATCH WIRING (Wire 1 Page)	
Parameter Name	Parameter Description	Value	Default	Access Level
Wire 1Src	Source address of the parameter to be wired	Modbus address	---- None	Conf
Wire 1 Dest	The destination for Wire 1	Modbus address	---- None	Conf
Wire 1 Status	Wire 1 Status	No Wire Failed OK	No Wire	Conf

The above parameters are repeated for Wire 2 to Wire 32.

Digital Communications

What is Digital Communications?

Digital Communications (or 'comms' for short) allows the controller to communicate with a PC or a networked computer system. A choice of comms protocol is available and can be selected in configuration level. For standard serial comms, the protocols are MODBUS (or JBUS), or EIBisynch, and modules can be fitted in both the H or J slots. For Profibus, Devicenet and Ethernet, modules can be fitted in the H slot only

For standard serial comms modules can be fitted use which EIA232, EIA485 or EIA422 Transmission Standards. A full description of these standards is given in the 2000 series Communications Handbook, part number HA026230.











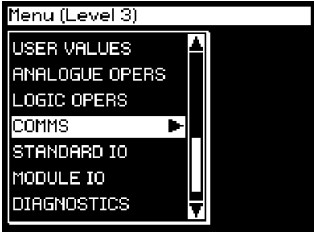

These modules can be fitted into either or both of two positions referred to as the H slot and the J slot which correspond to the rear terminal connections, see also Installation section of the User Guide. Both slot positions may be used at the same time. An example is to allow a multi-drop connection between a number of controllers and a computer running, say, a SCADA package on one comms position, and a separate PC used for configuration purposes on the second comms position. In this example an EIA485 module may be fitted for the multi-drop/SCADA requirement and EIA232 in the second position for the single PC/configuration requirement.

Notes:

- 1. When the controller is placed into Configuration Level it is taken 'off line' and placed into a standby state. In this state it no longer monitors or controls the plant.**
- 2. EIA232 etc is also commonly known as RS232 etc.**

To Configure Communications Parameters

The operation of the H and J Modules is the same.

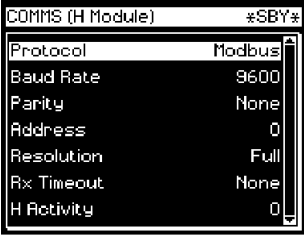
Do This	This Is The Display You Should See	Additional Notes
<ol style="list-style-type: none"> From any display press  as many times as necessary to access the page header menu Press  or  to select 'COMMS' 		
<ol style="list-style-type: none"> Press  to show Sub-headers Press  or  to select the 'H Module' 		<p>Digital communications modules may be fitted in either one or both positions.</p>
<ol style="list-style-type: none"> Press  to show the parameters Press  or  to scroll to the required parameter Press  to select the parameter Press  or  to change the value or state 		<p>The first parameter is 'Protocol'.</p>

Remaining parameters in the Analogue Operators list are accessed and adjusted in the same way.

The list of parameters available is shown in the following table:

H Module Parameters

Table 78:		This page allows you to configure Digital Communications fitted in slot H.		COMMS (H Module Page)	
Parameter Name	Parameter Description	Value	Default	Access Level	
Protocol	Comms protocol	Modbus EI Bisynch or Profibus ⁽¹⁾ Ethernet Devicenet		L3	
Baud Rate	Baud rate (not shown if Profibus)	Modbus/ Bisynch: 9600, 19200, 4800 Devicenet: 125K, 250K, 500K	9600	Conf	
Parity	Parity (Modbus only)	None Even Odd	None	Conf	
Address	Controller address	Devicenet 0 - 63 Bisynch 1 - 99 Modbus 1 -254 Profibus 0 -127 Ethernet 1 - 253	1	L1	
Resolution	Comms resolution (Modbus only)	Full Integer	Full	L3	
Delay	This introduces a short delay between messages to allow some 'intelligent' RS485 converters to switch between Rx and Tx modes. (not applicable if Ethernet)	No = 0ms Yes = 10ms	No	Conf	
Rx Timeout	H Comms timeout value (not shown if Devicenet)	None to 1:00:00		Conf	
H Activity	Comms activity in H module	0 or 1		L3 R/O	

Note: Profibus replaces EIBisynch if this option has been ordered. For Profibus instruments, only 'Address', 'Protocol' and 'Rx Timeout' parameters are displayed.

Ethernet Parameters

Table 79:		These parameters are displayed if Protocol = Ethernet		COMMS (H Module Page)		
Parameter Name	Parameter Description	Value	Default	Access Level		
Protocol	Comms protocol	Ethernet		L3		
Address	Controller address	1 - 253	1			
H Activity	Comms activity in H module	0 or 1		L3 R/O		
DHCP enable	See section Ethernet Technical Note	Fixed	Fixed			
		Dynamic				
IP address 1	See section Ethernet Technical Note	0 - 255	192			
IP address 2		0 - 255	168			
IP address 3		0 - 255	111			
IP address 4		0 - 255	222			
Subnet mask 1		0 - 255	255			
Subnet mask 2		0 - 255	255			
Subnet mask 3		0 - 255	255			
Subnet mask 4		0 - 255	0			
Default gateway		0 - 255	0			
Default gateway			0			
Default gateway			0			
Default gateway			0			
Pref mstr IP add			0			
Pref mstr IP add			0			
Pref mstr IP add			0			
Pref mstr IP add			0			
MAC address 1				00-00		
MAC address 2				00-00		
MAC address 3				00-00		

J Module Parameters

Table 80:		This page allows you to configure Digital Communications fitted in slot J.		COMMS (J Module Page)	
Parameter Name	Parameter Description	Value	Default	Access Level	
Protocol	Comms protocol	Modbus EI Bisynch		L3	
Baud Rate	Baud rate	Modbus/ Bisynch: 2400, 4800 and 9600	9600	Conf	
Parity	Parity (Modbus only)	None Even Odd	None	Conf	
Address	Controller address	Bisynch 1 - 99 Modbus 1 -254	1	L1	
Resolution	Comms resolution (Modbus only)	Full Integer	Full	L3	
Rx Timeout	J Comms timeout value	None to 1:00:00		Conf	
J Activity	Comms activity in J module	0 or 1		L3 R/O	

Digital Communications Diagnostics

Digital communications diagnostics is available under the Comms page menu. Two parameters are displayed. The H Rx and J Rx messages increments each time a valid message is received via the H Comms Module or J Comms module respectively. The Timed Out messages indicate a comms time out.

They are displayed as follows:

Table 81: This page allows you to monitor the number of times that a particular comms module has received a message		COMMS (Diagnostic Page)		
Parameter Name	Parameter Description	Value	Default	Access Level
H Rx Messages	Valid H comms messages received			L3 R/O
H Rx Timed Out	H Comms timeout			L3 R/O
J Rx Messages	Valid J comms messages received			L3 R/O
J Rx Timed Out	J Comms timeout			L3 R/O
Program Error ⁽¹⁾	Programmer Error codes	0 - 9	0	L3
Network Status ⁽²⁾	Network status Only shown if the Profibus or Devicenet option is configured in the H Module	Running Initialising Ready Offline Bad GSD (Profibus only)		L3 R/O

Note: If an invalid entry is made when setting up programs through the front panel, a pop up error message appears. If the program is set up over digital communications the error messages are displayed as a 'Program Error' as follows:-

Value	Mnemonic Reference	Meaning
0	PRG_ADV_EDIT_NOERROR_MR	No Error
1	PRG_ADV_EDIT_SEGOVER_MR	Not enough segments to perform the PASTE. This error appears if an attempt is made to copy and paste a program which has more segments than the controller has left.
2	PRG_ADV_EDIT_PWRFAIL_MR	The PASTE operation was interrupted by a power fail prior to completion.
3	PRG_ADV_EDIT_NOCOPYPROG_MR	Paste Program: The COPY program has not been selected.
4	PRG_ADV_EDIT_NOPASTEPROG_MR	Paste Program: Paste Program is the same as COPY program.
5	PRG_ADV_EDIT_PROG_RUNNING_MR	Paste Program: Program to be edited is currently running
6	PRG_ADV_EDIT_PROFILE_LOCKED_MR	Paste Program: Edits are not allowed to the program - it is locked.
7	PRG_ADV_EDIT_POOL_INIT_MR	Paste Program: Segment or Program Pool is being initialised (e.g. after a change is made to program mode i.e. ramp rate to time to target or vice versa)
8	PRG_ADV_EDIT_PROGFULL_MR	Program already has the maximum number of allowed segments.
9	PRG_ADV_EDIT_RANGE_ERROR_MR	Segment number is not valid for the program i.e. beyond the end of the program.

Note: If Profibus is selected from the previous page, it will be necessary, either to power cycle the controller, or to switch to operation level before this parameter is displayed.

Ethernet Technical Note

MAC address display

Each Ethernet module contains a unique MAC address, normally presented as a 12 digit hexadecimal number in the format "aa-bb-cc-dd-ee-ff".

In the **2704** instrument MAC addresses are shown as three separate values in the "COMMS" page, each representing 2 pairs of MAC address digits. The first (MAC1) shows the first two pairs of digits (example "AA-BB"), MAC2 shows to the third and fourth pair of MAC digits and MAC3 shows the fifth and sixth pairs of MAC digits. Under iTools these will appear as an integer value, e.g. 3A-E7 will display as 15079.

The MAC address can be found by powering up the instrument and navigating to the "COMMS" page.

DHCP Settings

You need to consult with your network administrator to determine if the IP Addresses for the instruments should be fixed or Dynamically allocated by a DHCP server.

If the IP Addresses are to be dynamically allocated then all MAC addresses must be supplied to the network administrator.

For fixed IP Addresses the Network Administrator will provide the IP address as well as a SubNet Mask. These must be configured into the instrument during set-up through the "COMMS" page. Remember to note the allocated addresses.

Instrument setup

Notes:

1. It is recommended that you setup the communications settings for each instrument *before connecting it to any Ethernet network*. This is not essential but network conflicts may occur if the default settings interfere with equipment already on the network. By default the instruments are set to a fixed IP address of 192.168.111.222 with a default SubNet Mask setting of 255.255.255.0.
2. IP Addresses are usually presented in the form "xxx.xxx.xxx.xxx". Within the instrument *each element of the IP Address are shown and configured separately*.
3. "**IP address 1**" relates to the first set of three digits, IP address 2 to the second set of three digits and so on. This also applies to the SubNet Mask, Default Gateway and Preferred master IP Address.

Network Connection

Screw the "RJ45" adapter into the instrument "H" port, as shown in the Appendix F.4.3. Use standard CAT5 cable to connect to the Ethernet 10BaseT switch or hub. Use cross-over cable only if connecting one-to-one with a PC acting as network master.

Dynamic IP Addressing

Within the "Comms" page of the instrument set the "DHCP enable" parameter to "Dynamic". Once connected to the network and powered, the instrument will acquire its "IP address", "SubNet Mask" and "Default gateway" from the DHCP Server and display this information within a few seconds.

Fixed IP Addressing

Within the "**Comms**" page of the instrument ensure the "**DHCP enable**" parameter is set to "Fixed", then set the IP address and SubNet Mask as required (and defined by your network administrator).

Additional Notes

1. The "**Comms**" page also includes configuration settings for "**Default Gateway**", these parameters will be set automatically when Dynamic IP Addressing is used. When fixed IP addressing is used these settings are only required if the instrument needs to communicate wider than the local area network i.e. over the internet.
2. The "**Comms**" page also includes configuration settings for "**Preferred Master**". Setting this IP address to the IP Address of a particular PC will guarantee that one of the 4 available Ethernet sockets will always be reserved for that PC (reducing the number of available sockets for anonymous connections to 3).

iTools Setup

iTools configuration package, version V5.64 or later, may be used to configure Ethernet communications.

The following instructions configure Ethernet.

To include a Host Name/Address within the iTools scan:-

1. Ensure iTools is **NOT** running before taking the following steps:
2. Within Windows, click '**Start**', the '**Settings**', then '**Control Panel**'
3. In control panel select '**iTools**'
4. Within the iTools configuration settings select the '**TCP/IP**' tab
5. Click the '**Add**' button to add a new connection
6. Enter a name for this TCP/IP connection
7. Click the '**Add**' button to add the host name or IP address (details from your network administrator) in the '**Host Name/ Address**' section
8. Click '**OK**' to confirm the new Host Name/IP Address you have entered
9. Click '**OK**' to confirm the new TCP/IP port you have entered
10. Click '**OK**' again and you should now see the TCT/IP port you have configured within the TCP/IP tab of the iTools control panel settings
11. iTools is now ready to communicate with an instrument at the Host Name/Ip Address you have configured

Addendum: 2704 Controller Specials Number Eu0678

APPLIES TO 2704 CONTROLLER FITTED WITH ETHERNET COMMUNICATIONS.

A parameter has been added to 2704 controllers fitted with Ethernet Communications.

The parameter is 'Unit Ident' and appears in the Ethernet Parameters List in the table below.

Unit Ident

The Modbus TCP Specification includes the 'normal' Modbus address as part of the packaged Modbus message – where it is called the Unit Identifier. If such a message is sent to an Ethernet to Serial gateway, the 'Unit Ident' is essential to identify the slave instrument on the serial port. When a stand alone Ethernet instrument is addressed, however, the 'Unit Ident' is not required since the IP address fully identifies the instrument. To allow for both situations the 'Unit Ident Enable' parameter is used to enable or disable checking of the Unit Ident received from TCP. The enumerations produce the following actions:-

- 'Instr': The received Unit Ident must match the Modbus address in the instrument or there will be no response.
- 'Loose': The received Unit Ident value is ignored, thus causing a reply regardless of the received 'Unit Ident'.
- 'Strict': The received Unit Ident value must be 0xFF or there will be no reply

The complete parameter list is shown below:-

Table 82:	These parameters are displayed if Protocol = Ethernet		COMMS (H Module Page)	
Parameter Name	Parameter Description	Value	Default	Access Level
Protocol	Comms protocol	Ethernet		L3
Address	Controller address	1 - 253	1	
Unit Ident	Unit Identifier enable/disable. See previous section for further explanation	Strict Loose Instr		Strict
H Activity	Comms activity in H module	0 or 1		L3 R/O
DHCP enable		Fixed	Fixed	
		Dynamic		
IP address 1		0 - 255	192	
IP address 2		0 - 255	168	
IP address 3		0 - 255	111	
IP address 4		0 - 255	222	
Subnet mask 1		0 - 255	255	
Subnet mask 2		0 - 255	255	
Subnet mask 3		0 - 255	255	
Subnet mask 4		0 - 255	0	
Default gateway			0	
Default gateway			0	
Default gateway			0	
Default gateway			0	
Pref mstr IP add			0	
Pref mstr IP add			0	
Pref mstr IP add			0	
Pref mstr IP add			0	
MAC address 1		00-00		
MAC address 2		00-00		
MAC address 3		00-00		

2704 Master Communications

Introduction

Software version 5 and above of the 2704 controller supports Master Communications. The objective of the master communications is to allow the 2704 to communicate with any instrument using ModBus interface as a master device, that is, without the need for a supervisory PC. This allows the 2704 to link through digital communications with other products to create a small system solution. There are two methods of communication:-

1. Broadcast Communications
2. Direct Read/Write

Broadcast Communications

The 2704 master can be connected to up to 32 slaves. The master sends a unit address of 0 followed by the address of the parameter which is to be sent. A typical example might be a multi zone oven where the setpoint of each zone is required to follow, with digital accuracy, the setpoint of a master.

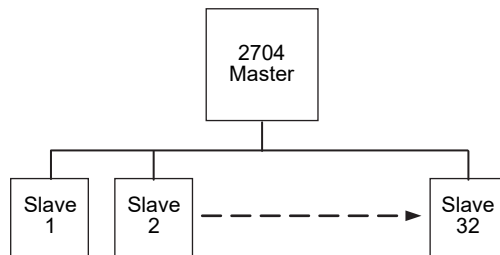

Direct read/write

The 2704 master can be connected to up to eight (sixteen from software version 6 onwards) slaves. Each slave has its own unit address. The master can send data to each slave by sending a unit address followed by the parameter address. It can also request data from a slave. This data may be displayed on the 2704 or used as part of a 2704 control strategy.

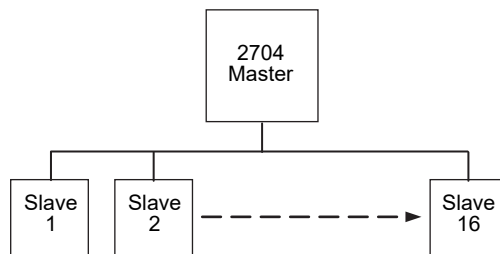

Wiring Connections

Before proceeding further, please read Appendix B, Safety and EMC information, in the above handbooks.

The Digital Communications module for the master is fitted in Communications Module slot J and uses terminals JA to JF.

The Digital Communications module for the slave is fitted in either slot J or slot H



EIA422, EIA485 4-wire or EIA232

Rx connections in the master are wired to Tx connections of the slave

Tx connections in the master are wired to Rx connections of the slave

This is shown diagrammatically below



EIA485 2-wire

Connect A (+) in the master to A (+) of the slave

Connect B (-) in the master to B (-) of the slave

This is shown diagrammatically below

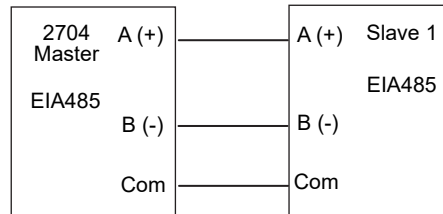
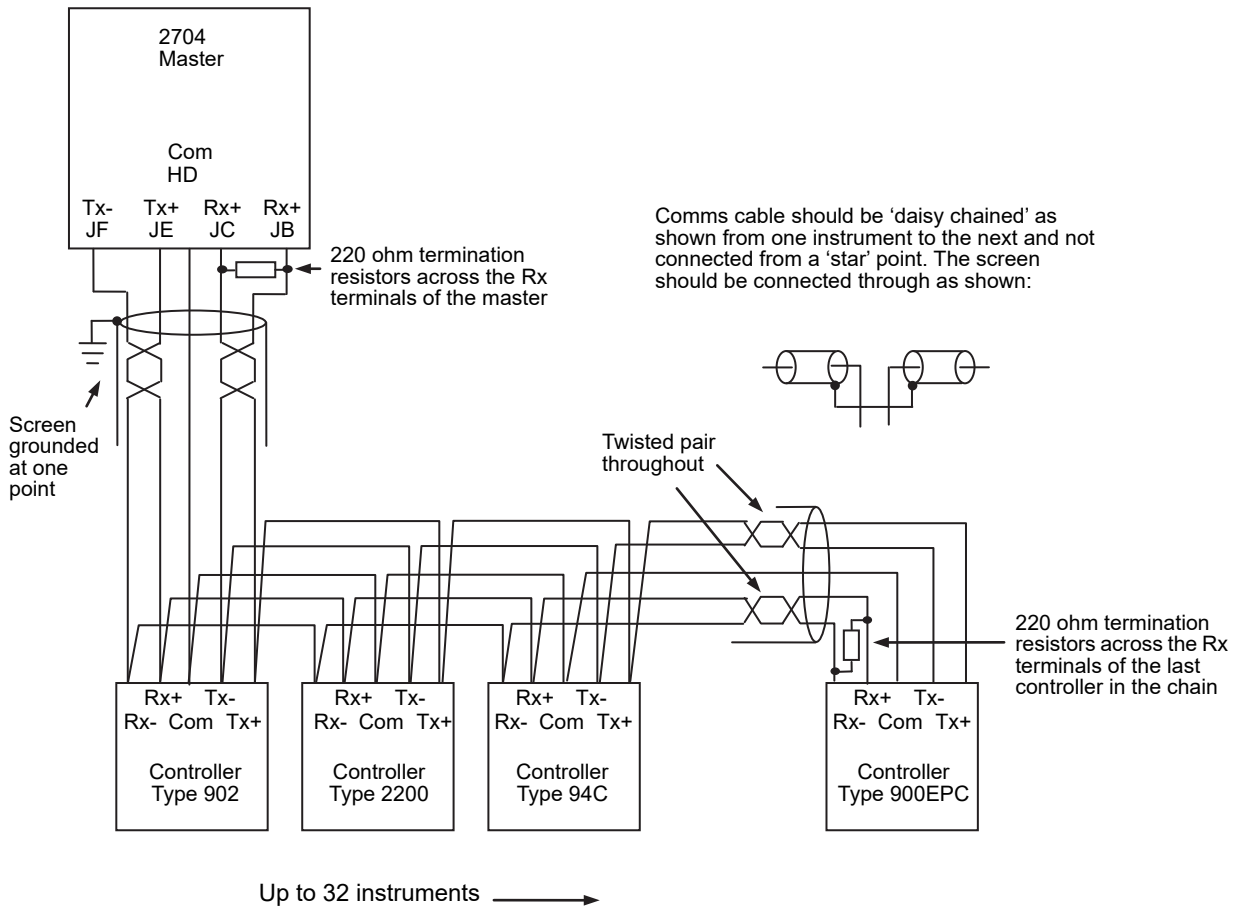

Figure 105 Master/Slave Connections

Example Wiring Diagrams for Different Slaves

The following diagrams show connections for a range of different controllers using EIA422. These are representative of typical slaves which may be used but could also include third party products using Modbus protocol.

EIA422 or EIA485 4-wire



Slave Terminal Numbers for Different Instruments					
Terminal Function	2200 2400 2600 2700	902/3/4	94C	900EPC	818/5
Tx+	HE	F1	11	X1	15
Tx-	HF	F2	12	X2	16
Rx+	HB	F3	13	X3	13
Rx-	HC	F4	14	X4	14
Com	HD	F5	15	X5	17

Figure 106 Example Wiring RS422 or RS485 4-wire for Different Slaves

EIA485 2-wire

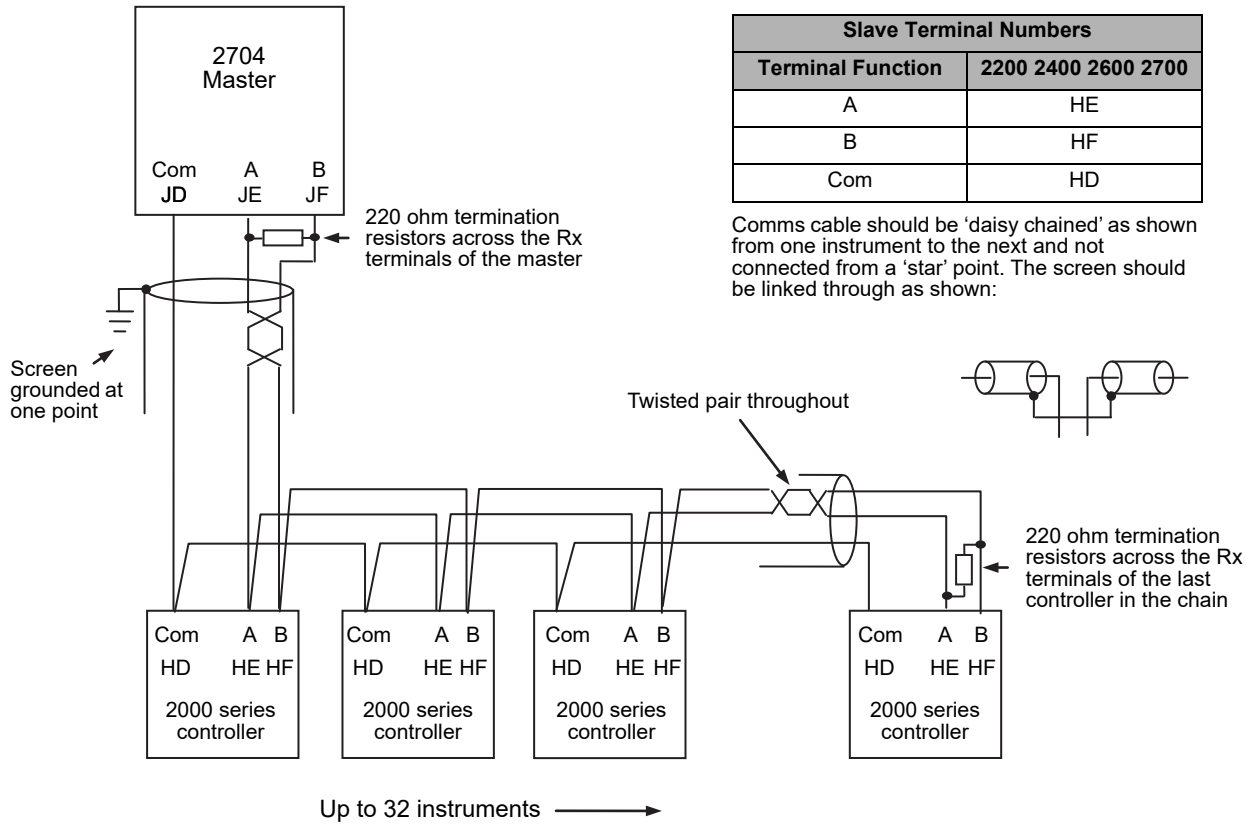

Figure 107 Example Wiring RS485 2-wire for 2000 Series Instruments

EIA232

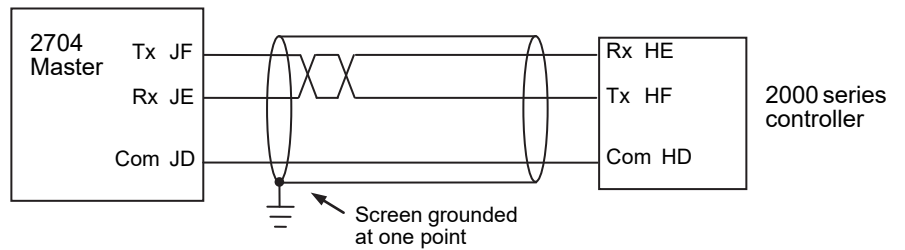











Figure 108 Example Wiring RS232 for 2000 Series Instruments

Cross-Board Version

If master communications is fitted as an upgrade, check also the cross-board version before configuring master comms. This parameter can be found in configuration level in 'INSTRUMENT (Info Page) 'CBC Version' and must be greater than 4.7 (displayed as 47).

To configure the controller for master communications it will be necessary to navigate to configuration access level (see Engineering Handbook). A summary of navigation is shown below.

Basic Navigation

- Parameters are organised into pages. - press  to access the page
- Each page is given a name or header which describes a particular subject - in this case 'MASTER COMMS' - press  or  to select the header
- The MASTER COMMS page is divided into sub-headings, for example 'Parameters', 'Slave 1', etc - press  to access
- Parameters for the chosen subject are found in these pages - press  or  to select the header
- To change the value of alterable parameters - press  again
- press  or 

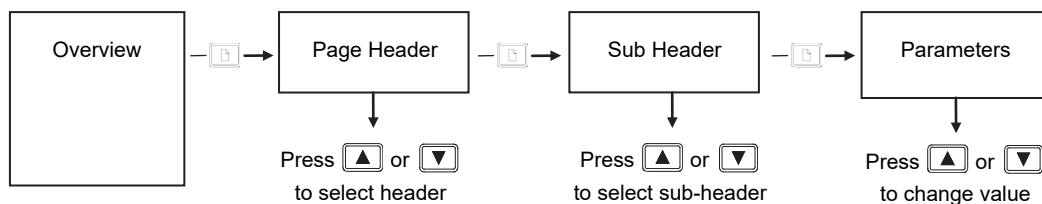

Figure 109 Summary of Basic Navigation

Examples are shown in the following two sections.







To Configure Parameters

Set controller access level to 'Config' as described in Access Levels.

The parameters required to configure a transaction between a local parameter in the master and a parameter in the slave are shown in section Parameter Tables. To configure these parameters:

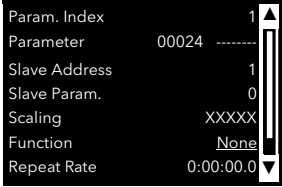
Do This	This Is The Display You Should See	Additional Notes
<ol style="list-style-type: none"> From any display press as many times as necessary to access the page header menu Press or to scroll to 'MASTER COMMS' 		
<ol style="list-style-type: none"> Press to display master comms sub-headings Press or to scroll around the list and choose 'Parameters' 		<p>These parameters configure a transaction between a local parameter in the 2704 and a parameter in a slave.</p>
<ol style="list-style-type: none"> Press to select the parameters in this list Press again to edit the required parameter, in this case 'Param Index' Press or to index the parameter 1 to 100 		<p>The flashing underline indicates the value can be changed</p>
<ol style="list-style-type: none"> Now press to select the 'Parameter' in the master Press or to set the Modbus address of the parameter 		<p>Commonly used parameters (see App. D -Engineering Handbook) are followed by a short description. To edit the parameter using this description press followed by or </p>
<ol style="list-style-type: none"> Now press to select the address of the slave in which to send (or receive) the parameter. Press or to change the value 		<p>In this example the slave address is 1. For broadcast comms set this value to 0</p>
<ol style="list-style-type: none"> Now press to select 'Slave Parameter' address Press or to change the value 		<p>Range 0 to 65535. This full range is only necessary for IEEE. It is necessary to give the full IEEE address to get true floating point. For example in Eurotherm controllers PV = 8002 Hex or 32770. (See also section IEEE in 2000 Series)</p>
<ol style="list-style-type: none"> Now press to select 'Scaling' for the parameter Press or to change the value 		<p>The choices are shown in the Master Comms Parameter Table section Parameter Tables.</p>



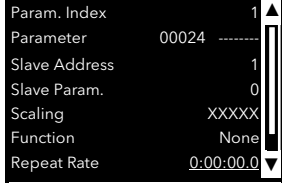





To Configure Parameters (Continued)

Do This	This Is The Display You Should See	Additional Notes
16. Now press  to select 'Function' 17. Press  or  to change the value		This sets the function to be read or write. See section Parameter Tables for full list of choices
18. Now press  to select 'Repeat Rate' 19. Press  or  to change the value		This sets the time between transmissions. 0 = continuous

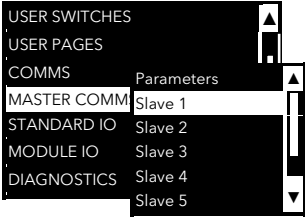
To Configure Slaves

The controller must be in 'config' mode.

The parameters required to configure the characteristics of the slaves are shown in section Parameter Tables. To configure the slave parameters:-

Do This	This Is The Display You Should See	Additional Notes
1. From the sub-headers menu press  or  to select the required slave		Up to eight (sixteen from software version 6 onwards) slaves can be configured
2. Press  to select the parameters in this list 3. Press  again to edit 'Address' 4. Press  or  to change the value		The flashing underline indicates the value can be changed. The slave address is in the range 0 to 254 and does not necessarily have to be the same as the slave number. 0 is reserved for broadcast comms.
Repeat 3 and 4 to set up following parameters.		See section Parameter Tables for a description of the parameters and settings

Parameter Tables

Table 83: These parameters configure a transaction between a local parameter in the 2704 and a parameter in a slave.			MASTER COMMS (Parameters)	
Parameter Name	Parameter Description	Value	Default	Access Level
Param. Index	Select up to 100 parameters to read or write to. (Increased from 38 from version 6 onwards)	1 to 100		
Parameter	The address of the parameter in the 2704 which is to be sent to a slave. OR the address in the 2704 in which a parameter sent from a slave is stored.	modbus address shown as 'address' followed by 'name of commonly used parameter'		
Slave Address	The address of the slave where the parameter is to be sent or received. 0 is broadcast mode in which the parameter is sent to all slaves	0 to 254		
Slave Param.	The parameter address in the slave	0 to 65535		
Scaling	Scaling of the parameter in the slave No. of decimal points Time transmitted as seconds Time transmitted as minutes Time transmitted as hours Time transmitted as tenths of seconds Time transmitted as tenths of minutes Time transmitted as tenths of hours IEEE Float 32 bit (see section IEEE in 2000 Series) Time transmitted as 32 bit msec	XXXXX to X.XXXX sss mmm hhh ss.s mm.m hh.h Euro REAL Euro TIME		
Function See Note below	Disables the transaction Set to Read(3) for parameters with modbus function code 3 Set to Read(4) for parameters with modbus function code 4 Set to Write to write at a repeat rate Set to Change Write to write only if the parameter value has changed	None Read(3) Read(4) Write Change Write		
Repeat Rate	Time between transmissions. 0 is continuous	0 to 99:59:59.9		
Status	Set to good on leaving config Slave returned illegal address Slave returned illegal value Slave returned Modbus exception Error in message returned by slave Value read was out of limits or the parameter is unalterable Parameter is OEM secured and will not be transmitted No response from slave The master has no parameter associated with the specified modbus address. Config only Parameter value unchanged since last transmit. Relevant to change write only. The slave does not support block write	Good Addr Error Data Error Error Failed Store Error Secured Timed Out No Parameter Unchanged No Block Write		

Note: Function codes are a single byte instruction to the slave describing the action to perform.

Function code 3 – Read Output Registers - allows the binary contents of holding registers to be obtained from the addressed slave.

Function code 4 – Read Input Registers – obtains the contents from input registers of the addressed slave.

For the 2000 range of controllers either function code can be used. For other slaves refer to the manufacturers documentation.

Table 84: These parameters configure the characteristics of the slaves			MASTER COMMS (Slave1 to 8 Page)	
Parameter Name	Parameter Description	Value	Default	Access Level
Address	The modbus address of the slave	0 to 254		
Resolution	To set resolution configured in the slave to Full or Integer	Full Integer	Full	
Timeout(msecs)	Time to wait for a response from a slave	20 to 2000	100mS	
Retries	Number of times to retry before the status goes to 'Timed Out'	1 to 100	1	
Status	Offline and Online are user selectable. If the transaction is not completed in the time set by the 'Timeout' parameter in the specified number of 'Retries' the message 'Timeout' will be displayed. The message 'Recovering' appears fleetingly	Offline Online Timed Out Recovering		
Block Write	Set to the maximum block size supported by the slave. For IEEE this must be set to >0 (see also section IEEE in 2000 Series)	0 to 100	0	

Additional Notes

IEEE in 2000 Series

This section applies specifically to 2000 series instruments. If the slave is not a series 2000 instrument, a knowledge of the communications format for the slave is required.

One of the main limitations of Modbus is that only 16 bit integer representations of data can normally be transferred. In most cases, this does not cause a problem, since appropriate scaling can be applied to the values without losing precision. If the slave is a series 2000 instrument, where all values are shown on a 4 digit display, values may be transferred in this way. However this has the significant drawback that the scaling factor to be applied needs to be known at both ends of the communications link.

One further problem is that certain 'time' parameters, notably those used for the programmer function can be returned over the communications link in tenths of seconds, minutes or hours. It is possible, therefore, for long durations to overflow the 16 bit Modbus limit.

To overcome these problems, a sub protocol has been defined, using the upper portion of the Modbus address space (8000h and upwards), allowing full 32 bit resolution floating point and timer parameters. This upper area is known as the IEEE region.

This sub-protocol provides two consecutive Modbus addresses for all parameters. The base address for any given parameter in the IEEE region can easily be calculated by taking its normal Modbus address, doubling it, and adding 8000h. For example, the address in the IEEE region of the Target Setpoint (Modbus address 2) is simply

$$2 \times 2 + 8000h = 8004h = 32772 \text{ decimal}$$

This calculation applies to any parameter in a series 2000 slave that has a Modbus address.

Access to the IEEE area is made via block reads (Functions 3 & 4) and writes (Function 16). Attempts to use the 'Write a Word' (Function 6) operation will be rejected with an error response. Furthermore, block reads and writes using the IEEE region should only be performed at even addresses, although no damage to the instrument will result in attempting access at odd addresses. In general, the 'number of words' field, in the Modbus frame, should be set to 2 times what it would have been for 'normal' Modbus.

The rules governing how the data in the two consecutive Modbus addresses are organised depending on the 'data type' of the parameter.

See also 'Series 2000 Communications Handbook Part No HA026230.

Configuration Mode

The Master does not communicate in configuration mode.

During configuration, if there is no parameter in the master with the specified modbus address the Status is set to 'No Parameter' and on exit from configuration mode all parameters defining that transaction are set to their cold start values.

Parameter Name	Cold Start Value
Parameter	None
Slave Address	1
Slave Parameter	0
Repeat Rate	0:00:00.0
Function	None
Scaling	XXXXX
Status	Good

Standard IO

What is Standard IO?

Standard IO refers to the fixed Input/Output connections as listed in Table 85 below. Parameters such as input/output limits, filter times and scaling of the IO can be adjusted in the Standard IO pages.

This chapter also describes **User Scaling** of the standard IO.

The controller is calibrated for life against known reference standards during manufacture, but user scaling allows you to offset the 'permanent' factory calibration to either:

1. Scale the controller to your reference standards
2. Match the calibration of the controller to an individual transducer or sensor
3. To compensate for known offsets in process measurements

These offsets can be made to parameters in the Standard IO pages.

STANDARD IO ▶	<i>(PV Input Page)</i>	Allows access to parameters which set up the fixed Process Variable Input connected to terminals VH, VI, V+ and V-. This is, generally, the PV input for a single loop controller.
	<i>(An Input Page)</i>	Allows access to parameters which set up the fixed Analogue Input connected to terminals BA, BB and BC. This is the high level input from a remote source.
	<i>(AA Relay Page)</i>	Allows access to parameters which set up the fixed Relay output connected to terminals AA, AB and AC. This relay may be used as an alarm relay. a time proportioning control output or valve raise or lower..
	<i>(Dig IO1 Page)</i> to <i>(Dig IO7 Page)</i>	Allows access to parameters which set up the fixed digital IO connected to terminals D1 to D7 and DC.
	<i>(Diagnostic Page)</i>	Allows access to parameters which set up the fixed digital Input connected to terminal D8 and DC.

Note: Names shown in italics can be customised.

Table 85: Standard I/O

PV Input

Allows access to parameters which set up the fixed Process Variable Input connected to terminals VH, VI, V+ and V-. This is the PV input for a single loop controller.

To Scale the PV Input

Scaling of the PV input applies to linear process inputs only, eg linearised transducers, where it is necessary to match the displayed reading to the electrical input levels from the transducer. PV input scaling is not provided for direct thermocouple or RTD inputs.

Figure 110 shows an example of input scaling. where an electrical input of 4-20mA requires the display to read 2.5 to 200.0 units.

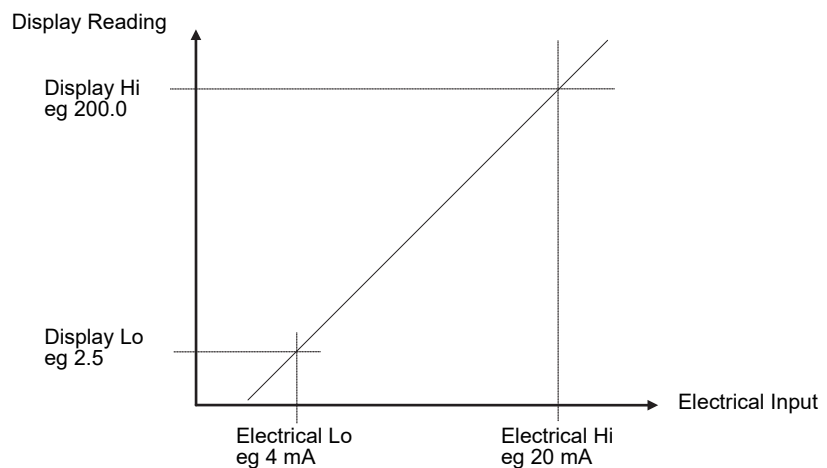











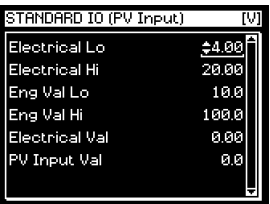



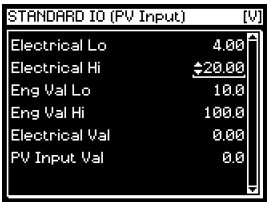



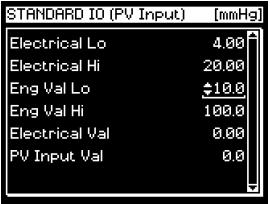



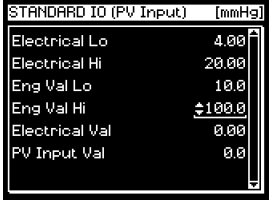

Figure 110 Input Scaling (Standard IO)

Offset

Offset has the effect of moving the whole curve, shown in Figure 110, up or down about a central point. The 'Offset' parameter is found in the STANDARD IO (PV Input) page as shown in the controller view in Section Standard IO PV Input Parameters.

To scale a linear PV Input proceed as follows: (This may be carried out at Access Level 3)

Do This	This Is The Display You Should See	Additional Notes
1. From any display press  as many times as necessary to access the page header menu 2. Press  or  to select 'STANDARD IO'		The PV Input is connected to terminals VH, V+, V-.
3. Press  to show Sub-headers 4. Press  or  to select 'PV Input' (if necessary)		
5. Press  to show 'Electrical Lo' 6. Press  again to select 'Electrical Lo' 7. Press  or  to adjust the value		Set this value to the lowest level of the input, eg 4mA. The units displayed here may be mV, V, mA or Ohms depending on what type of input is configured.
8. Press  to select 'Electrical Hi' 9. Press  or  to adjust the value		Set this value to the highest level of the input, eg 20mA.
10. Press  to select 'Eng Value Lo' 11. Press  or  to adjust the value		Set up the displayed value (instrument minimum span) which corresponds to the Electrical Lo input, eg 2.50
12. Press  to select 'Eng Value Hi' 13. Press  or  to adjust the value		Set up the displayed value (instrument maximum span) which corresponds to the Electrical Hi input, eg 200.00



To View and Change Input Filter Time

An input filter provides damping of the input signal. This may be necessary to prevent the effects of excessive noise on the PV input.

The filter may be turned off or set in steps of 0.1sec up to 10mins

If the input is configured to accept process levels, eg 4-20mA, as in the above example, the parameter which follows 'Eng Value Hi' is 'Filter Time'.

For thermocouple and RTD inputs the first parameter to be displayed is the Input Filter Time, since the input scaling parameters do not appear for specific linearised inputs.

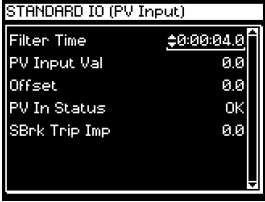
Do This	This Is The Display You Should See	Additional Notes
1. From the previous display press  to select 'Filter Time' 2. Press  or  to adjust the Filter Time between Off and 10mins		

The following table gives the full list of parameters available under the PV Input list header. This list of parameters set up the fixed Process Variable Input connected to terminals VH, VI, V+ and V-. This is the PV input for a single loop controller. ↓↓

Standard IO PV Input Parameters

Table 86: This page allows you to configure the PV Input Parameters			STANDARD IO (PV Input Page)	
Parameter Name	Parameter Description	Value	Default	Access Level
Channel Type	Input/Output type	RTD, Thermocouple, Pyrometer 40mV, 80mV, mA, Volts, HZVolts, Log 10		Conf
Linearisation	Input linearisation	See note 1		Conf
Units	Engineering units	See Appendix D.2.		Conf
Resolution	Display resolution	XXXXX to X.XXXX or SCI		Conf
CJC Type	CJC type Only shown if 'Channel Type' = 'Thermocouple'	Internal 0°C 45°C 50°C None	Internal	Conf
SBrk Impedance	Sensor break enable for certain high output impedance sensors	Off Low High	Off	Conf
SBrk fallback	Sensor break fallback	Off Down scale Up Scale		Conf
The following four parameters do not appear for 'Channel Type' = 'Thermocouple' or 'RTD'				
Electrical Lo	Electrical low input level	Input range		L3.
Electrical Hi	Electrical high input level	Input range		L3
Eng Value Lo	Low display reading	Display		L3
Eng Value Hi	High display reading	range		L3

Table 86: This page allows you to configure the PV Input Parameters			STANDARD IO (PV Input Page)	
Parameter Name	Parameter Description	Value	Default	Access Level
Filter Time	PV input filter time.	↕ Off to 0:10:00.0		L3
Emissivity	Emissivity. Only appears if the PV input is configured as a pyrometer	Off to 1.00		L3
Electrical Val	The current electrical value of the PV input	Input range		R/O L1
PV Input Val	The current value of the PV input in engineering units.	Display range		R/O L1
Offset	Transducer scaling offset.	Display range		R/O L3
CJC Temp	CJC Temperature. Only appears if the PV input is configured for thermocouple	Display Range		R/O L1
PV In Status	PV input status	See Appendix D		R/O L1
SBrk Trip Imp	Sensor break value	0 to 100% See section Sensor Break Value.		R/O L1
PV Input Name	User defined name for PV input. Select from User Text Page Section Instrument User Text Page.	User text	Default Text	Conf
Cal State	Calibration state	See Calibration		Conf
Rear Term Temp	Temperature at the rear terminals	Auto See note 2		Conf

Notes:**1. Input Linearisation**

J Type, K Type, L Type, R Type, B Type, N Type, T Type, S Type, Platinel II, C Type, PT 100, Linear, Square Root, Custom 1, Custom 2, Custom 3.

2. Rear Terminal Temperature

Auto means that the controller automatically measures the temperature at the rear terminals for use with cold junction compensation. The temperature of the rear terminals can be measured externally, if required, and this measured value can then be entered manually when calibrating CJC.

Analogue Input

Allows access to parameters which set up the fixed Analogue Input connected to terminals BA, BB and BC. This is the high level input from a remote source.

To Scale the Analogue Input

The procedure is the same as that described in section To Scale the PV Input.

Standard IO Analogue Input Parameters

Table 87: This page allows you to configure the Analogue Input Parameters			STANDARD IO (An Input Page)	
Parameter Name	Parameter Description	Value	Default	Access Level
Channel Type	Input/Output type	Volts mA		Conf
Linearisation	Input linearisation	See note 1		Conf
SBrk fallback	Sensor break fallback	Off Down scale Up Scale		Conf
SBrk Impedance	Sensor break enable for certain high output impedance sensors	Off Low High	Off	Conf
Units	Engineering units	See Appendix D.2.		Conf
Resolution	Display resolution	XXXXX to X.XXXX or SCI		Conf
Electrical Lo	Electrical low input level	Input range. Units depend on configuration		L3.
Electrical Hi	Electrical high input level			L3
Eng Value Lo	Low display reading	Display range. Units depend on configuration		L3
Eng Value Hi	High display reading			L3
Filter Time	PV input filter time	Off to 0:10:00.0		L3
Electrical Val	The current electrical value of the PV input	Input range		R/O
An Input Val	The current value of the Analogue input in engineering units <i>An Input</i> can be a user defined name.	Display range		R/O
Offset	Transducer scaling offset.			
An In Status	Status of the analogue input	OK Diagnostic messages are displayed to show the state of the Input if not OK. See Appendix D		R/O
SBrk Trip Imp	Sensor break value	0 to 100% See section Sensor Break Value.		R/O
An Input Name	User defined name for the analogue input. Select from User Text Page Section Instrument User Text Page.		Default Text	Conf
Cal State	Calibration state	See Calibration		Conf

Notes:

1. Input Linearisation

J Type, K Type, L Type, R Type, B Type, N Type, T Type, S Type, Platinel II, C Type, PT 100, Linear, Square Root, Custom 1, Custom 2, Custom 3.

Sensor Break Value

The controller continuously monitors the impedance of a transducer or sensor connected to any analogue input (including plug in modules described in the following chapter). This impedance, expressed as a percentage of the impedance which causes the sensor break flag to trip, is a parameter called 'SBrk Trip Imp' and is available in the parameter lists associated with both Standard and Module inputs of an analogue nature.

The table below shows the typical impedance which causes sensor break to trip for various types of input and high and low 'SBrk Impedance parameter settings. The impedance values are only approximate ($\pm 25\%$) as they are not factory calibrated.

PV Input (Also applies to PV Input module and Dual PV Input module)		Analogue Input	
mV input ($\pm 40\text{mV}$ or $+80\text{mV}$)		Volts ($\pm 10\text{V}$)	
SBrk Impedance – High	~ $10\text{K}\Omega$	SBrk Impedance – High	~ $50\text{K}\Omega$
SBrk Impedance - Low	~ $3\text{K}\Omega$	SBrk Impedance - Low	~ $10\text{K}\Omega$
Volts input (-3V to $+10\text{V}$) and HZ Volts input (-1.5 to 2V)			
SBrk Impedance – High		~ $500\text{K}\Omega$	
SBrk Impedance - Low		~ $100\text{K}\Omega$	

Fixed Relay Output

Allows access to parameters which set up the fixed Relay output connected to terminals AA, AB and AC. This relay may be used as an alarm relay. or a time proportioning control output.

To Scale The Fixed Relay Output

If the relay is used as a time proportioning control output this means that the relay will, by default, be fully off for 0% power demand, fully on for 100% power demand and equal on/off times at 50% power demand.

As with input scaling you can change these limits to suit the process. It is important to note, however, that these limits are set to safe values for the process. For example, for a heating process it may be required to maintain a minimum level of temperature. This can be achieved by applying an offset at 0% power demand which will maintain the relay on for a period of time. Care must be taken to ensure that this minimum on period does not cause the process to overheat.

These offsets can be made to parameters in the 'AA Relay' pages. The above example is shown in Figure 111.

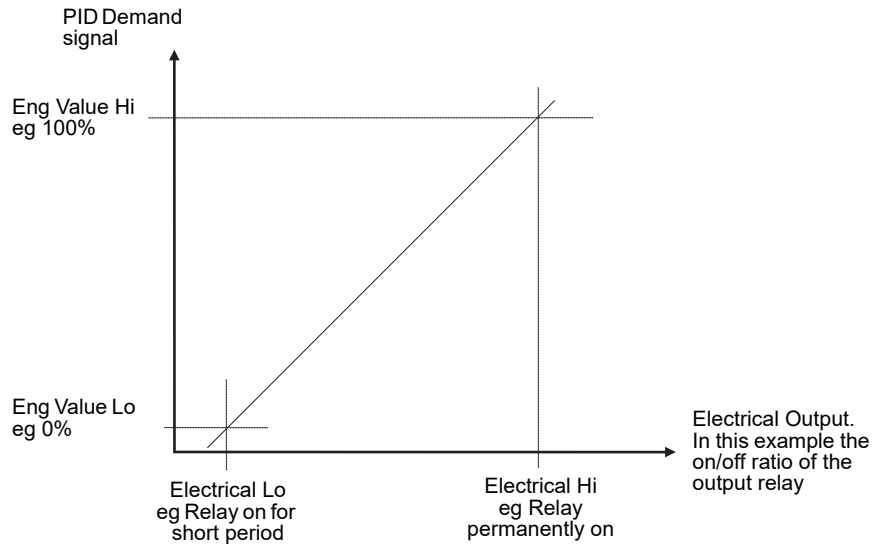











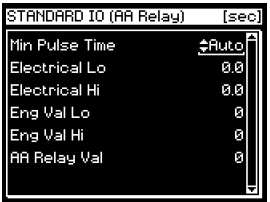







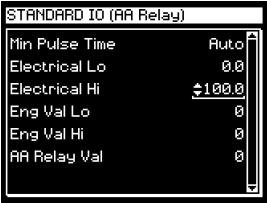



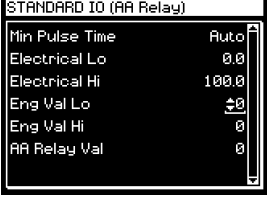



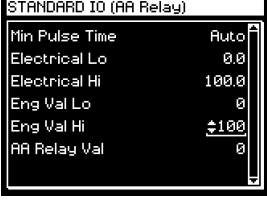



Figure 111 Fixed Relay Scaling

To set up and scale the Fixed Relay Output proceed as follows: (This can be done in Level 3)

Do This	This Is The Display You Should See	Additional Notes
1. From any display press  as many times as necessary to access the page header menu 2. Press  or  to select 'STANDARD IO'		The AA Relay is connected to terminals AA,AB and AC
3. Press  to show Sub-headers 4. Press  or  to scroll to the AA Relay Page		
5. Press  to show the AA Relay parameter list 6. Press  again to select 'Min Pulse Time' 7. Press  or  to choose 'Auto' or a minimum on/off time for the relay		This parameter applies to time proportioning outputs only. Auto = 0.05sec
8. Press  to select 'Electrical Lo' 9. Press  or  to adjust the value		If the relay is wired to the PID output demand signal, as shown in Figure 111, set this to a low value, normally 0.

Do This	This Is The Display You Should See	Additional Notes
10. Press  to select 'Electrical Hi' 11. Press  or  to adjust the value		If the relay is wired to the PID output demand signal, as shown in Figure 111, set this to a high value, normally 100.
12. Press  to select 'Eng Value Lo' 13. Press  or  to adjust the value		Set up this value so that the relay switches fully off corresponding to the Electrical Low setting
14. Press  to select 'Eng Value Hi' 15. Press  or  to adjust the value		Set up this value so that the relay switches fully on corresponding to the Electrical High setting

The following table gives the full list of parameters available under this list header 

The Fixed Relay Output Parameters

These parameters configure the fixed relay output connected to terminals AA, AB and AC. This relay may be used as an alarm, time proportioning or On/Off control output.

Standard IO AA Relay Parameters

Table 88: This page allows you to configure the Fixed Relay Parameters			STANDARD IO (AA Relay)	
Parameter Name	Parameter Description	Value	Default	Access Level
Channel Type	Function of the relay	On/Off Time Proportion Valve Lower Valve Raise	As order code	Conf
Wire Src	AA relay source	Modbus address		Conf
Invert	Relay energised Relay de-energised	Normal Inverted		Conf
The following five parameters only appear if 'Channel Type' = 'Time Proportion'				
Min Pulse Time	Minimum relay on or off time	Auto = 0.05s or 0.1 to 999.9	20sec	L3
Electrical Lo	Electrical low input level	Input range		L3
Electrical Hi	Electrical high input level	Input range		L3
Eng Value Lo	Low display reading	Display range		L3
Eng Value Hi	High display reading			L3
AA Relay Value ⁽¹⁾ AA Relay can be user text.	Status of the relay output See note 1	-100 to 100 -ve values not used	(editable if not wired)	R/O L3
Electrical Val	The current (analogue) value of the output			R/O L3
Channel Name	A name which replaces AA Relay from User Text			Conf
Relay AA Val Enu See also section Custom Enumerations.	Enumeration for the relay AA value on/off only	Not Enumerated	Not Enumerated	Conf
Elec Value Enum See also section Custom Enumerations.	Enumeration for the electrical value on/off only	01:Usr1 to 50:Usr50		Conf

Note: If the relay is wired to a source such as a loop output (Ch1 or Ch2) the 'value' will read in a positive direction only, i.e. it does not signify heating or cooling but just the position of the relay.

If configured for control 0 = Relay off; 100 = on; 1 to 99 = time proportioning
 If configured as On/Off 0 = Relay Off; Any other value (+ or -) = Relay On

Standard IO Dig I/O parameters

This page allows access to parameters which set up the fixed digital IO connected to terminals D1 to D7 and DC.

The standard digital IO1 to 7 can either be input or output and is set up in configuration level. The choices are:-

1. Digital Input IO configured as a digital input
2. On/Off IO configured as a digital output
3. Time Proportion IO configured as a control output
4. Valve Lower IO configured to raise the output of a motor valve controller
5. Valve Raise IO configured to lower the output of a motor valve controller

The parameters which appear in the Dig IO pages depend upon the function of the digital IO configured. These are shown in the following section.

When the logic outputs are configured as time proportioning outputs, they can be scaled as described in section To Scale The Fixed Relay Output.

Standard Digital IO Parameters

Table 89: This page allows you to configure the Digital I/O Parameters			STANDARD IO (Dig IO1 to 7 Page)	
Parameter Name	Parameter Description	Value	Default	Access Level
Channel Type	Input/Output type	Digital Input On/Off Time Proportion Valve Lower Valve Raise		Conf
Wire Src	Source of the signal to operate a digital output. This parameter does not appear for digital input	Modbus address		Conf
Invert	Normal/inverted I/O	Normal Inverted		Conf
The following five parameters only appear if 'Channel Type' = 'Time Proportioning'				
Min Pulse Time	Minimum logic on or off time.	Auto = 0.05s or 0.1 to 999.9	20sec	L3
Electrical Lo	Electrical low input level	Input range		L3
Electrical Hi	Electrical high input level	Input range		L3
Eng Value Lo	Low display reading	Display		L3
Eng Value Hi	High display reading	range		L3
Dig IO1 Val ⁽¹⁾	If Channel Type = Digital Input this reads the state of the input	0 = Off 1 = On		R/O L1
	If configured as an output this reads the desired output value	or -100 to 100		
Electrical Value ⁽¹⁾	If Channel Type = Digital Input this value does not appear			R/O L3
	If configured as an output this reads the actual electrical value.	0 or 1		
Channel Name	A name which replaces Dig IOx from User Text			Conf

Table 89: This page allows you to configure the Digital I/O Parameters			STANDARD IO (Dig IO1 to 7 Page)	
Parameter Name	Parameter Description	Value	Default	Access Level
Dig IO Enum See also section Custom Enumerations.	Enumeration for the electrical value on/off output or Digital Input only	Not Enumerated	Not Enumerated	Conf
Elec Value Enum See also section Custom Enumerations.	Enumeration for the electrical value on/off only	01:Usr1 to 50:Usr50		Conf

Note: Only settings between 0 & 100 are valid for Dig IO-Val. The corresponding Electrical value is shown in the following table:-

Channel Type	Dig IO- Val	Electrical Value
On/Off	0 to 100	0 to 1
Time Proportion	0 to 100	0.00 (off) to 1.00 (on). Time proportions between 0.00/1.00 for other positive settings of Dig IO- Val
Valve Raise/Lower	0 to 100	0.00 to 100.00

Standard IO Diagnostic Parameters

This page allows you to configure a name for the digital input and to inspect its status or that of the IO Expander if fitted. The parameters are shown in the following table.

Standard IO Diagnostic Parameters Table

Table 90: This page allows you to inspect Digital Input 8 or IO Expander status			STANDARD IO (Diagnostic Page)	
Parameter Name	Parameter Description	Value	Default	Access Level
Dig In8 Val	Status of digital input 8	Off On		R/O
Dig In E1 Val	Status of IO expander input	Off On		R/O
Bad Channels	A bad input or output will be displayed as ■ and will occur if the I/O is either a short or open circuit	□□□□□□□ to ■■■■■■■■		R/O
Dig In 8 Name	A name which replaces Dig In8 from User Text			Conf

Module IO

What is Module IO?

Additional analogue and digital IO is provided by plug in IO modules, which can be fitted in any of five slots (see also Introduction).

The type and position of any modules fitted in the controller is shown in the order code printed on the label on the side of the controller. This can be checked against the order code in Appendix A.

The module part number is printed on the side of the plastic case of the module.

Modules are available as single channel, two channel or three channel IO as listed below:

Module	Order Code	Idents Displayed As	Number of Channels	Module Part No.
Change over relay	R4	Form C Relay	1	AH025408U002
2 pin relay	R2	Form A Relay	1	AH025245U002
Dual relay	RR	Dual Relay	2	AH025246U002
Triac	T2	Triac	1	AH025253U002
Dual triac	TT	Dual Triac	2	AH025409U002
DC control	D4	DC Control	1	AH025728U003
DC retransmission	D6	DC Retrans	1	AH025728U002
PV input	PV	PV Input	1	AH026359U00
Triple logic input	TL	Tri-Logic IP	3	AH025317U002
Triple contact input	TK	Tri-Contact IP	3	AH025861U002
Triple logic output	TP	Tri-Logic OP	3	AH025735U002
24V transmitter supply	MS	MS	1	AH025863U002
5Vdc Transducer power supply	G3	Transducer PSU	1	AH026306U002
10Vdc Transducer power supply	G5	Transducer PSU	1	AH026306U002
Potentiometer input	VU	Pot Input	1	AH025864U002
Analogue input module (2604/2704 dc Input)	AM	DC Input	1	AH025686U004
Dual PV input (Dual Probe Input)	DP	Dual PV In	2	AH026359U003
Isolated single logic output	LO	Sin-Logic OP	1	AH025735U002
Dual DC output	DO	Dual DC Out	2	AH027249U002
High resolution DC retransmission output	HR	HR DC Out	2	AH027249U003
TDS Input *		TDS Input	1	AH027720U002
4-wire Pt100 Input	PH	4Wire PT100	1	AH028494U002
4-wire Pt25 Input	PL	4Wire PT25	1	AH028494U003









*** The TDS Input Module is designed primarily for use in boiler control applications and is described in Boiler Control.**

Table 91: I/O Modules

Parameters for the above modules, such as input/output limits, filter times and scaling of the IO, can be adjusted in the Module IO pages. The procedures are very similar to those covered in Standard IO.

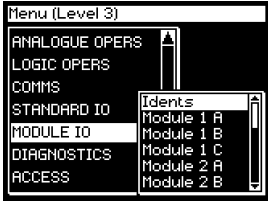
Module Identification

To identify which module is fitted into which slot:

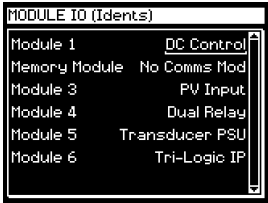
Do This	This Is The Display You Should See	Additional Notes
<p>1. From any display press  as many times as necessary to access the page header menu</p> <p>2. Press  or  to select 'MODULE IO'</p>		
<p>3. Press  to show Sub-headers</p>		<p>Idents Summary of modules fitted</p> <p><i>Module XA</i> X = Module number</p> <p><i>Module XB</i> A, B, C =</p> <p><i>Module XC</i> Single, Two, Three, channels respectively</p> <p>The above is repeated for every module fitted.</p> <p>The name of the module is user configurable</p>
<p>4. Press  or  to scroll to the required Sub-headers</p> <p>5. Press  to select the parameter list for the required sub-header.</p>		<p>This view shows the 'Ident' page which is read only.</p> <p>If a module is fitted in any module position, it's type, as listed in Table 91, is displayed.</p> <p>'No Module' is displayed if the slot is empty.</p>

The full list of parameters available under these list headers is shown in the following tables:

Idents Page

Table 92: This page allows you to read the type of module fitted.			MODULE IO (Idents Page)	
Parameter Name	Parameter Description	Value	Default	Access Level
<i>Module 1</i>	Actual module fitted	See note 1		L1 R/O
Memory Module	Memory module position	No Module		L1 R/O
<i>Module 2</i>	Actual module fitted	See note 1		L1 R/O
<i>Module 3</i>	Actual module fitted	See note 1		L1 R/O
<i>Module 4</i>	Actual module fitted	See note 1		L1 R/O
<i>Module 5</i>	Actual module fitted	See note 1		L1 R/O
<i>Module 6</i>	Actual module fitted	See note 1		L1 R/O

Note: The module name is configurable by the user.

Module Messages









No Module	Bad Ident	Form C Relay	Form A Relay	Triac
Dual Relay	Dual Triac	DC Control	DC Retrans	PV Input
Tri-Logic IP	Tri-Contact IP	Tri-Logic OP	Transmitter PSU	Transducer PSU
DC Input	Dual PV Input	Sin-Logic OP	Pot Input	Diff Input
DC Control	HR DC Out	Dual DC Out	4W PT100	4W PT25

These are also listed in Table 91.

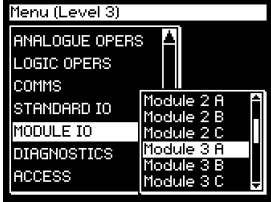
Module IO Parameters

Each module has a unique set of parameters which depend on the function of the module fitted.

To view and alter parameters associated with each module:

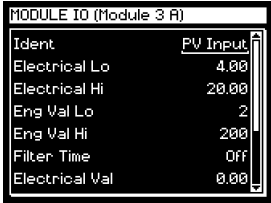
Do This	This Is The Display You Should See	Additional Notes
1. From the MODULE IO sub-header display press  or  to choose the required module		If a module is not fitted in the selected position the sub header is not displayed (A), (B), (C) refer to the output channel of a single, dual or triple module respectively The name of the module is user configurable
2. Press  to show the list of parameters for the selected module 3. Press  again to select the first parameter 4. Press  again to scroll to a parameter which you wish to change 5. Press  or  to change its value		If the channel is not used the message 'No Parameters' is displayed

Tables in the following pages show the parameters available for different module types

DC Control and DC Retransmission

Table 93:	This page allows you to configure a DC Output module for control or retransmission. This does not apply to the Dual DC or High Resolution Retransmission output modules		MODULE IO (Module 1 (A))	
Parameter Name	Parameter Description	Value	Default	Access Level
Ident	Module identification	DC Output		R/O
Channel Type	I/O type	Volts mA		Conf
Wire Src	Source to which the channel is wired	Modbus address		Conf
Electrical Lo	Electrical low input level	O/P range		L3 See output scaling
Electrical Hi	Electrical high input level	O/P range		
Eng Value Lo	Low display reading	Disp. range		
Eng Value Hi	High display reading	Disp. range		
Electrical Val	The current electrical value of the output in operation mode	0 to 10.00V or 0 to 20mA		R/O L3
Module 1A Val	The current output value in operation mode. 'Module 1A' can be a user defined text.	+100.0% -ve values are not used		R/O L3
Cal Trim	Analogue output calibration trim. Only available in calibration mode. See section DC Output Module.			Conf
Channel Name	User defined name for the channel. Select from User Text Page Section Instrument User Text Page.		Default Text	Conf
Cal State	Calibration status	See Calibration		R/O
This module has a single output. Its parameters are displayed under 'channel' (A).				

Relay Output

Table 94:		This page allows you to configure a Relay Output module.		MODULE IO (Module 1 (A) Page)	
		Types included: Form C Relay; Form A Relay; Dual Relay.			
Parameter Name	Parameter Description	Value	Default	Access Level	
Ident	Module identification	Relay		R/O	
Channel Type	Channel/Module Type	On/Off Time Proportion Valve Lower Valve Raise		Conf	
Wire Src	Wire source	Modbus address		Conf	
Invert	Relay energised Relay de-energised	Normal Inverted		Conf	
The following five parameters only appear if Channel Type is set to Time Proportion.					
Min Pulse Time	Minimum relay on or off time	Auto = 0.05s or 0.07 to 150.00	5 sec	L3 Only shown for time prop. O/Ps	
Electrical Lo	Electrical low input level	O/P range			
Electrical Hi	Electrical high input level	O/P range			
Eng Value Lo	Low display reading	Disp. range			
Eng Value Hi	High display reading	Disp. range			
Elect Val Enum	Enumeration for the electrical value on/off only. See also section Custom Enumerations	Not Enumerated	Not	Conf	
Eng Value Enum	Enumeration for the engineering value on/off only. See also section Custom Enumerations	01:Usr1 to 50:Usr50	Enumerated	Conf	
Electrical Val	The current electrical value of the output in operation mode	0.00 or 1.00 (time prop)		R/O L3	
<i>Module 1A</i> Val	The current output value in operation mode. ' <i>Module 1A</i> ' can be user text.	±100.0% -ve values are not used		R/O L3	
Channel Name	User defined name for the channel. Select from User Text Page Section Instrument User Text Page		Default Text	Conf	
The changeover relay and 2 pin relay are single output modules. The parameters above are displayed under 'channel' (A) only. Dual Relay has two outputs. The parameters above are displayed under Channel A and C.					

Triac Output

Table 95:		This page allows you to configure a Triac Output module. Types included:- Triac; Dual Triac		MODULE IO (Module 1(A) Page)	
Parameter Name	Parameter Description	Value	Default	Access Level	
Ident	Module identification	Triac		R/O	
Channel Type	Channel/Module Type	On/Off Time Proportion Valve Lower Valve Raise		Conf	
Wire Src	Wire source	Modbus address		Conf	
Invert	Invert triac operation	Normal Inverted		Conf	
The following five parameters only appear if Channel Type is set to Time Proportion.					
Min Pulse Time	Minimum triac on or off time	Auto = 0.05s or 0.07 to 150.00	5 sec	L3 Only shown for time prop. O/Ps	
Electrical Lo	Electrical low input level	O/P range			
Electrical Hi	Electrical high input level	O/P range			
Eng Value Lo	Low display reading	Disp. range			
Eng Value Hi	High display reading	Disp. range			
Elect Val Enum See	Enumeration for the electrical value on/off only. See also section Custom Enumerations	Not Enumerated	Not	Conf	
Eng Value Enum	Enumeration for the engineering value on/off only. See also section Custom Enumerations	01:Usr1 to 50:Usr50	Enumerated	Conf	
Electrical Val	The current electrical value of the output in operation mode	0.00 or 1.00 (time prop)		R/O L3	
<i>Module 1A</i> Val	The current output value in operation mode. ' <i>Module 1A</i> ' can be user text.	±100.0% -ve values are not used		R/O L3	
Channel Name	User defined name for the channel. Select from User Text Page Section Instrument User Text Page		Default Text	Conf	
The changeover relay and 2 pin relay are single output modules. The parameters above are displayed under 'channel' (A) only. Dual Relay has two outputs. The parameters above are displayed under Channel A and C.					

Triple Logic Output and Single Isolated Logic Output

Table 96:		This page allows you to configure a Logic Output module.		MODULE IO (Module 1 (A) Page)	
Parameter Name	Parameter Description	Value	Default	Access Level	
Ident	Module identification	Logic Output		R/O	
Channel Type	Channel/Module Type	On/Off Time Proportion Valve Lower Valve Raise		Conf	
Wire Src	Wire source	Modbus address		Conf	
Invert	Invert logic operation	Normal Inverted		Conf	
The following five parameters only appear if Channel Type is set to Time Proportion.					
Min Pulse Time	Minimum on or off time	Auto = 0.05s or 0.07 to 150.00	Auto	L3 Only shown for time prop. O/Ps	
Electrical Lo	Electrical low input level	O/P range			
Electrical Hi	Electrical high input level	O/P range			
Eng Value Lo	Low display reading	Disp. range			
Eng Value Hi	High display reading	Disp. range			
Elect Val Enum	Enumeration for the electrical value on/off only. See also section Custom Enumerations	Not Enumerated to	Not Enumerated	Conf	
Eng Value Enum	Enumeration for the engineering value on/off only. See also section Custom Enumerations	01:Usr1 to 50:Usr50	Not Enumerated	Conf	
Electrical Val	The current electrical value of the output in operation mode	0.00 or 1.00 (time prop)		R/O L3	
Module 1A Val	The current output value in operation mode. 'Module 1A' can be user defined text.	±100.0% -ve values are not used		R/O L3	
Channel Name	User defined name for the channel. Select from User Text Page Section Instrument User Text Page.		Default Text	Conf	
This module has three outputs. Each output is found under Module 1(A), (B) and (C).					

Triple Logic and Triple Contact Input

Table 97:		This page allows you to set the parameters for a Triple Logic Input module.		MODULE IO (Module 1 (A) Page)	
Parameter Name	Parameter Description	Value	Default	Access Level	
Ident	Module identification	Logic Input		R/O	
Channel Type	Channel/Module Type	Digital Input	Digital Input	Conf	
Invert	Invert input operation	Normal Invert		Conf	
Eng Val Enum	Enumeration for the Module 1A Val. See also section Custom Enumerations	Not Enumerated 01:Usr01 50:Usr50	Not Enumerated	Conf	
Module 1A Val	The current input value. 'Module 1A' can be user defined text.	0 = Off 1 = On		R/O	
Channel Name	User defined name for the channel. Select from User Text Page Section Instrument User Text Page.		Default Text	Conf	

This module has three inputs. Each input is found under Module 1(A), (B) and (C).

Transmitter Power Supply

Table 98:		This page allows you to set the parameters for a Transmitter Power Supply module.		MODULE IO (Module 1 (A) Page)	
Parameter Name	Parameter Description	Value	Default	Access Level	
Ident	Module identification	Transmitter PSU		R/O	
Channel Type	Input/Output type	Transmitter PSU	Transmitter PSU	Conf	
Module 1A Val	The current value in engineering units. 'Module 1A' can be user defined text.			R/O	
Channel Name	User defined name for the channel. Select from User Text Page Section Instrument User Text Page.		Default Text	Conf	

This module has a single output providing 24Vdc at 20mA. Its parameters are displayed under 'channel' (A).

Transducer Power Supply

Table 99:		This page allows you to set the parameters for a Transducer Power Supply module.		MODULE IO (Module x (A) Page)	
Parameter Name	Parameter Description	Value	Default	Access Level	
Ident	Module identification	Transmitter PSU		R/O	
Voltage	Voltage select	Transmitter PSU			
Shunt	Selects calibration resistor fitted internally within the controller or externally (eg in the transducer)	External Internal			
Wire Src	Wire source	Modbus address			
Electrical Value	The current output electrical value in operation mode	0.00 to 10			
Module 1A Val	The current value in engineering units. 'Module 1A' can be a user defined name.			R/O	
Channel Name	User defined name for the channel. Select from User Text Page Section Instrument User Text Page.		Default Text	Conf	

This module has a single output. Its parameters are displayed under 'channel' (A).

Potentiometer Input

Table 100:		This page allows you to set the parameters for a Potentiometer Input module.		MODULE IO (Module x (A) Page)	
Parameter Name	Parameter Description	Value	Default	Access Level	
Ident	Pot Input			R/O	
Units	Engineering units.	See section Precision PV Input / Module.		Conf	
Resolution	Display resolution	XXXXX to X.XXXX or SCI (scientific)		Conf	
SBrk Fallback	Sensor break fallback	Off Downscale Upscale		Conf	
Eng Val Lo	Engineering value low	Display range		L3	
Eng Val Hi	Engineering value high			L3	
Filter Time	Input filter time	Off to 0:10:00.0		L1	
Module 1A Val	The current value in engineering units. 'Module 1A' can be a user defined name.			R/O	
Module Status	Module Status	See section Dual (Probe) Input Module.		R/O	
Channel Name	User defined name for the channel. Select from User Text Page Section Instrument User Text Page		Default Text	Conf	
Cal State	Allows the potentiometer to be calibrated.	Idle Pot Low Pos Pot High Pos Restore Fact	Idle	L3	

This module has a single input. Its parameters are displayed under 'channel' (A).

PV Input

Table 101:		This page allows you to set the parameters for a PV Input module. This module can only be fitted in slots 3 or 6.		MODULE IO (Module 3 or 6 (A) Page)	
Parameter Name	Parameter Description	Value	Default	Access Level	
Ident	Module identification	PV Input		R/O	
Channel Type	Input/Output type	RTD Thermocouple Pyrometer 40mV 80mV mA Volts HZVolts Log10		Conf	
Linearisation	Input linearisation	See note 1		Conf	
Units	Engineering units	See section Precision PV Input / Module.		Conf	
Resolution	Display resolution	XXXXX to X.XXXX or SCI		Conf	
SBrk Impedance	Sensor break enable for high output impedance sensors. See section Zirconia Probe Impedance Measurement	Off Low High	Off	Conf	
SBrk fallback	Sensor break fallback	Off Down scale Up Scale		Conf	
CJC Type	CJC type Only shown if Channel Type = thermocouple	Internal 0°C 45°C 50°C None	Internal		

The following four parameters are only shown for 'Channel Type' = mV, Volts, mA, and HZVolts

Table 101:		This page allows you to set the parameters for a PV Input module. This module can only be fitted in slots 3 or 6.		MODULE IO (Module 3 or 6 (A) Page)	
Parameter Name	Parameter Description	Value	Default	Access Level	
Electrical Lo [units]	Electrical low input level	Input range. units depend on channel type		L3. Only shown for mV, V, mA	
Electrical Hi [units]	Electrical high input level				
Eng Val Lo	Low display reading	Display range.			
Eng Val Hi	High display reading				
Filter Time	Input filter time	Off to 0:10:00.0		L1	
Emissivity	Emissivity Ch Type = pyrometer only	Off to 1.00			
Electrical Val [units]	The current electrical value of the input	Input range		R/O L3	
Module 3A (or 6A) Val	The current value in engineering units. 'Module 3(6)A' can be user defined text.			R/O	
CJC Temp	Temperature read at the rear terminals °C Ch Type = thermocouple only			R/O	
Offset	To apply a simple offset over the whole input range	Display range		L3	
Module Status	Module status See Appendix D3	OK or message		R/O	
SBrk Trip Imp	Sensor break value Read as a % of the SBrk Impedance configured	See section Zirconia Probe Impedance Measurement.		R/O	
Channel Name	User defined name for the channel. Select from User Text Page Section Instrument User Text Page.		Default Text	Conf	
Cal State	Calibration state Not shown for Pyrometer or mA inputs	See Calibration		Conf	
Rear Term Temp	Allows a user measured offset to be entered for CJC calibration Ch Type = thermocouple only	Auto to 50.00oC			
This module has a single input. Its parameters are displayed under 'channel' (A).					

Notes:**1. Input Linearisation**

J Type, K Type, L Type, R Type, B Type, N Type, T Type, S Type, Platinel II, C Type, PT 100, Linear, Square Root, Custom 1, Custom 2, Custom 3, PT 25.5.

DC Input

Table 102:		This page allows you to set the parameters for a DC Input module. This module can only be fitted in slots 1, 3, 4 or 6.		MODULE IO (Module x (A) Page)		
Parameter Name	Parameter Description	Value	Default	Access Level		
Ident	Module identification	DC Input		R/O		
Channel Type	Input/Output type	RTD Thermocouple Pyrometer mV mA Volts HZVolts Log10		Conf		
Linearisation	Input linearisation	See note 1		Conf		
Units	Engineering units	See section Precision PV Input / Module.		Conf		
Resolution	Display resolution	XXXXX to X.XXXX or SCI		Conf		
SBrk Impedance	SSensor break enable for high output impedance sensors	Off Low High	Off	Conf		
SBrk fallback	Sensor break fallback	Off Down scale Up Scale		Conf		
CJC Type	CJC type Only shown if Channel Type = thermocouple	Internal 0°C 45°C 50°C None	Internal			
The following four parameters are only shown for 'Channel Type' = mV, V, mA, and HZVolts						
Electrical Lo	Electrical low input level	Input range units depend on channel type		L3. See 'To Scale the PV Input'		
Electrical Hi	Electrical high input level					
Eng Value Lo	Low display reading		Display range.			
Eng Value Hi	High display reading					
Filter Time	Input filter time	Off to 0:10:00.0		L3		
Emissivity	Emissivity (Pyrometer input only)	Off to 1.00		R/O		
Electrical Val	The current electrical value of the input	Input range units as configured		R/O		
Module 3A Val (or 1,4 or 6A)	<i>The current value in engineering units 'Module 3A (1,4 or6A)' can be user defined text.</i>			R/O		
Offset	Transducer scale offset	Display range	0	L3		
CJC Temp	Temperature read at the rear terminals °C Thermocouple inputs only			R/O		
Module Status	Module status	See section Dual (Probe) Input Module.		R/O		
SBrk Trip Imp	Current sensor break value Read as a % of the SBrk Impedance configured	See section Sensor Break Value.		R/O		
Channel Name	User defined name for the channel. Select from User Text Page Section Instrument User Text Page.		Default Text	Conf		
Cal State	Allows input to be calibrated. Not shown for Pyrometer or mA inputs	See Calibration	Idle	Conf		
Rear Term Temp	Allows a user measured offset to be entered for CJC calibration Ch Type = thermocouple only	Auto to 50.00°C				
This module has a single input. Its parameters are displayed under 'channel' (A).						

Note: Input Linearisation

J Type, K Type, L Type, R Type, B Type, N Type, T Type, S Type, Platinel II, C Type, PT 100, Linear, Square Root, Custom 1, Custom 2, Custom 3, PT 25.5.

Dual PV Input

The dual PV input module accepts two inputs - one from a high level source (channel A) and one from a low level source (channel C). The two inputs are not isolated from each other and have an update rate of 5Hz. One application for the module is for a Zirconia probe input.

The module can also be configured for a single input when the update rate becomes 10Hz.

Table 103:		This page allows you to set the parameters for Channel A of a Dual PV Input module. This module can only be fitted in slots 3 or 6.		MODULE IO (Module 3(A) Page)		
Parameter Name	Parameter Description	Value	Default	Access Level		
This module has two inputs. Parameters are displayed under 'channel' (A) and 'channel' (C) Channel A is the high level input, channel C is the low level input. This assumes that 'En Dual Mode' = 'Yes' in the Channel C menu. If 'En Dual Mode' = 'No', then this module will behave as a single PV Input module, see section PV Input. This table shows Module 3 (or 6)A parameters						
Ident	Channel identification	High Level Inp		R/O		
Channel Type	Input/Output type	HZ Volts Volts		Conf		
Linearisation	Input linearisation	See note 1		Conf		
Units	Engineering units	See section Precision PV Input / Module.		Conf		
Resolution	Display resolution	XXXXX to X.XXXX or SCI (scientific)		Conf		
SBrk Impedance	Sensor break impedance for sensors with high output impedance	Off Low High	Off	Conf		
SBrk Fallback	Sensor break fallback	Off Downscale Upscale		Conf		
Electrical Lo	Electrical low input level	Input range units depend on channel type		L3		
Electrical Hi	Electrical high input level			See 'To Scale the PV Input' L3		
Eng Val Lo	Low display reading		Display range			
Eng Val Hi	High display reading					
Filter Time	Input filter time	Off to 0:10:00.0				
Electrical Val	The current electrical value of the input	Input range units as configured		R/O		
Module 3A Val (or 6A Val)	The current value in engineering units. 'Module 3A (or 6A)' can be user defined text.			R/O		
Offset	Transducer scale offset	Range limits				
Module Status	Module status	See section Precision PV Input / Module.		R/O		
SBrk Trip Imp	Current sensor break value Read as a % of the SBrk Impedance configured	See section Sensor Break Value.		R/O		
Channel Name	User defined name for the channel. Select from User Text Page Section Instrument User Text Page.		Default Text	Conf		
Cal State	Allows input calibration Only shown when 'En Dual Mode' = 'No' (section Dual PV Input)	See Chapter	Idle	Conf		

Notes:

1. Input Linearisation

J Type, K Type, L Type, R Type, B Type, N Type, T Type, S Type, Platinel II, C Type, PT 100, Linear, Square Root, Custom 1, Custom 2, Custom 3, PT 25.5 .

Table 104:		This page allows you to set the parameters for Channel C of a Dual PV Input module. This module can only be fitted in slots 3 or 6.		MODULE IO (Module 3(C) Page)	
Parameter Name	Parameter Description	Value	Default	Access Level	
This module has two inputs. Parameters are displayed under 'channel' (A) and 'channel' (C) Channel A is the high level input, channel C is the low level input. This table shows Module 3 (or 6)C parameters					
Ident	Channel identification	Low Level Input		R/O	
Channel Type	Input/Output type	DC Input	DC Input	Conf	
En Dual Mode	Enable dual mode See note 2	Yes No			
Linearisation	Input linearisation	See note 1		Conf	
Units	Engineering units	See Appendix D		Conf	
Resolution	Display resolution	XXXXX to X.XXXX or SCI (scientific)		Conf	
SBrk Impedance	Sensor break impedance for high impedance output sensors	Off Low High	Off	Conf	
SBrk Fallback	Sensor break fallback	Off Downscale Upscale		Conf	
CJC Type	CJC type Only shown if Channel Type = Thermocouple	Internal 0°C 45°C 50°C None	Internal	Conf	
Filter Time	Input filter time	Off to 0:10:00.0		L3	
Emissivity	Emissivity Only shown if Channel Type = Pyrometer	Off to 1.00		L3	
Electrical Val	The current electrical value of the input	Input range units depend on channel type		R/O	
Module 3 (or 6) A Val	The current value in engineering units. 'Module 3A (or 6A)' can be user defined text.			R/O	
Offset	Transducer scale offset	Range limits			
CJC Temp	Temperature read at the rear terminals °C Thermocouple inputs only			R/O	
SBrk Trip Imp	Current sensor break value Read as a % of the SBrk Impedance configured	See section Sensor Break Value		R/O	
Channel Name	Channel name		Default Text	R/O	

Note 2: The parameters in the above two tables are displayed when '**En Dual Mode**' = '**Yes**'

If '**En Dual Mode**' = '**No**', then the module can be used as a single input with an update rate of 10Hz. Channel C parameters are then not applicable and the list of Channel A parameters becomes identical to the parameter list for the single PV Input module, see section PV Input

To calibrate the module it is necessary to set '**En Dual Mode**' = '**Yes**'

4-Wire RTD Input

Two special input modules for PRT type sensors are available that can satisfy basic requirements of metrology applications in terms of stability and resolution. Module code PH is optimised to work with Pt100 and module code PL is optimised to work with Pt25.5.

It is possible to use module PL with Pt100 in order to obtain $\pm 0.5\text{mK}$ input resolution but then the maximum measurable temperature would be reduced to less than 50°C .

Table 105: This page allows you to set the parameters for 4-Wire (PT100 or PT25) Modules. These module can only be fitted in slots 3 or 6.			MODULE IO (Module 3 or 6 (A) Page)	
Parameter Name	Parameter Description	Value	Default	Access Level
Ident	Module identification	4W PT100 or 4W PT25		R/O
Linearisation	Input linearisation	See note 1		Conf
Units	Engineering units	See section Precision PV Input / Module.		Conf
Resolution	Display resolution	XXXXX to X.XXXX or SCI	XX.XXX	Conf
SBrk Impedance See section .	Sensor break enable a.c. type (i.e. no errors)	Off Low High	Off	Conf
SBrk fallback	Sensor break fallback	Off Down scale Up Scale	Off	Conf
Filter Time	Input filter time	Off to 0:10:00.0	0:00:01.6	L1
Electrical Val [units]	The current electrical value of the input	Input Reading in [Ohms]		R/O L3
Module 3A (or 6) Val	The current value in engineering units. 'Module 3 (6)A' can be user defined text.			R/O
Offset	To apply a simple offset over the whole input range	Display range		L3
Module Status	Module status See Appendix D	OK or message		R/O
SBrk Trip Imp	Sensor break % of the threshold impedance that sets SB			R/O
Channel Name	User defined name for the channel. Select from User Text Page Section Instrument User Text Page.		Default Text	Conf
Cal State	Calibration state	See Calibration.		Conf
This module has a single input. Its parameters are displayed under 'channel' (A).				

Note1: Input Linearisation

J Type, K Type, L Type, R Type, B Type, N Type, T Type, S Type, Platinel II, C Type, PT 100, Linear, Square Root, Custom 1, Custom 2, Custom 3, PT 25.5.

Dual DC Output

This module (order code DO) can be fitted in slots 4, 5 and 6 with a maximum of three in any single controller.

It contains two output channels. Each channel can be either 4-20mA control output, with 12 bit resolution, or a 24Vdc (20 to 30Vdc) transmitter supply. The module provides full 240Vac isolation.

This module may be used if:

- extra analogue outputs are required to implement the control functionality
- extra precision and stability of control is desired. This because the module is power efficient and, therefore, does not cause significant temperature fluctuation inside the instrument
- extra power sources (fully isolated) are needed for passive current transmitters, active transducers requiring 20V to 30V source or I/Os of open collector type.

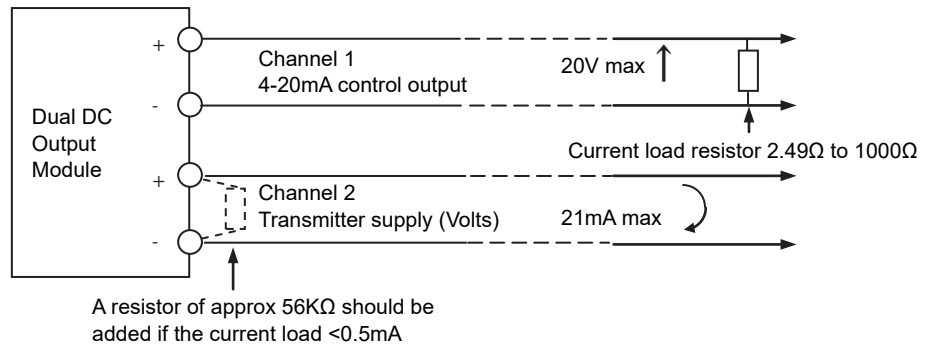
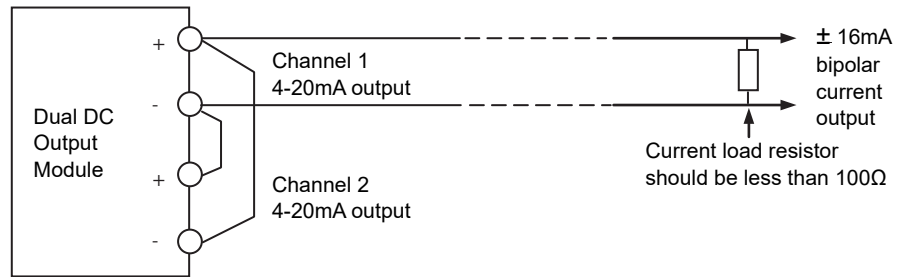

Figure 112 Ch1 & Ch2 Configured as Current Control & PSU



Channel 1 & 2 set up:

Eng Val Lo	-100%	Alternatively one channel can be used with fixed 4mA while the other is varied between 4 and 20mA.
Eng Val Hi	100%	
Elec Lo	4mA	The polarity of the desired signal depends on which channel is fixed
Elect Hi	20mA	

Figure 113 Connections to Obtain a Bipolar (+16mA) Current Output

Dual DC Output Module IO Parameters

Table 106:		This page allows you to set the parameters for a Dual DC Output module. This module can only be fitted in slots 1, 4, and 5.		MODULE IO (Module 4(C) Page)	
Parameter Name	Parameter Description	Value	Default	Access Level	
This module has two outputs. Parameters are displayed under 'channel' (A) and 'channel' (C). Channel A and channel C can be 4-20mA or PSU outputs.					
Ident	Channel identification	DC Out		R/O	
Channel Type	Output type mA = analogue output Volts = transmitter PSU	mA Volts		Conf	
Module Status	Module status	See section Dual (Probe) Input Module.		L3	
Channel Name	User defined name for the channel. Select from User Text page, section Instrument User Text Page		Default text	Conf	
The following parameters are shown for Channel Type = mA only					
Wire Src	Source to which the channel is wired	Modbus address		Conf	
Electrical Lo	Electrical low input level	O/P range	4.00 min	L3. See output scaling	
Electrical Hi	Electrical high input level	O/P range	20.00 max		
Eng Value Lo	Low display reading	Disp. range			
Eng Value Hi	High display reading	Disp. range			
Electrical Val	The current electrical value of the output in operation mode	4 to 20mA		R/O L3	
<i>Module 1 (4 or 5) A Val (can be user defined text).</i>	The current output value in operation mode.	±100.0% -ve values are not used		R/O L3	
Cal state	Allows the module to be calibrated	Idle Cal Low Confirm Go Now Trim O/P Accept Cal High Restore Factory Save	Idle	Conf	
Cal Trim	Output calibration trim Only appears when Cal State = Now Trim O/P			Conf	

High Resolution Retransmission Output

This module (order code HR) can be fitted in slots 1, 4, and 5 with a maximum of three in any single controller.

It contains two output channels. The first channel provides a high resolution, 15 bit, 4-20mA or 0-10Vdc retransmission signal. The second provides 24Vdc (20 to 30Vdc) transmitter supply. The module provides full 240Vac isolation.

This unit has been designed for use as a conditioning circuit for complex passive sensors/transducers such as may be found in a carbon potential control system.

The high resolution is achieved in feedback mode using a PID control loop. The retransmission variable provides the setpoint for the PID loop. The output from the module provides the PV input to the loop which corrects for any variations in the output signal.

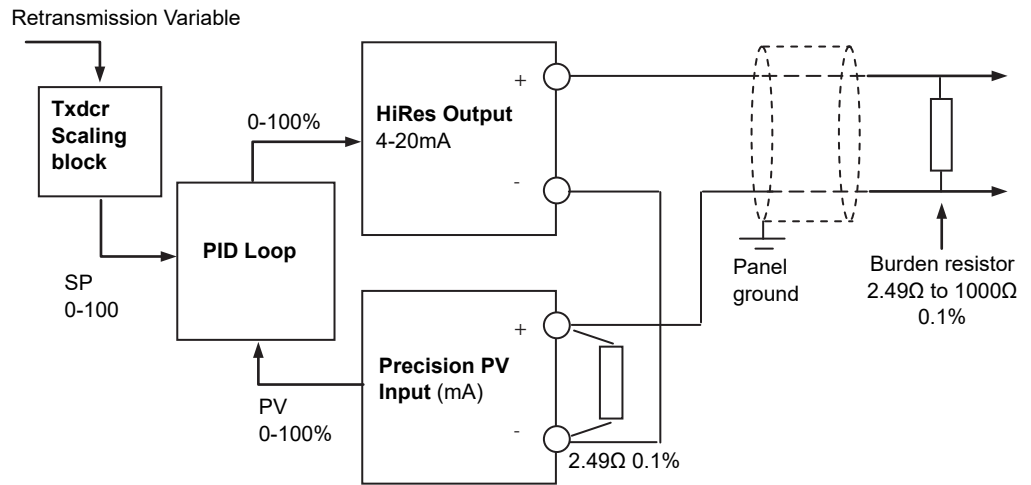

Precision PV Input set up:

Elec Lo	4mA
Elec Hi	20mA
Filter time	0.2sec

PID Loop set up

Proportional band (PB)	125%
Integral time (Ti)	0.4sec
Derivative time (Td)	Off

All the internal variables of the loop and their limits are set to 0 –100% range.

Figure 114 Precision 4-20mA Current Loop Retransmission (15bit) using a single precision PV input module.

Notes:

1. To guarantee that the 4-20mA range is fully covered the channel output is calibrated at 3.8mA (cal low) and 20.5mA (cal High).
2. To utilise the full potential for high accuracy/resolution extra care should be taken to ensure low levels of EM interference as follows:-
 - keep connecting cables away from power cables
 - ground 'Dig Common' of the controller to local panel ground
 - use shielded cables with the shield connected to local panel ground

Precise 4-20mA Current Loop Retransmission (14bit)

Using Dual (probe) module and a feedback loop with input from channel A

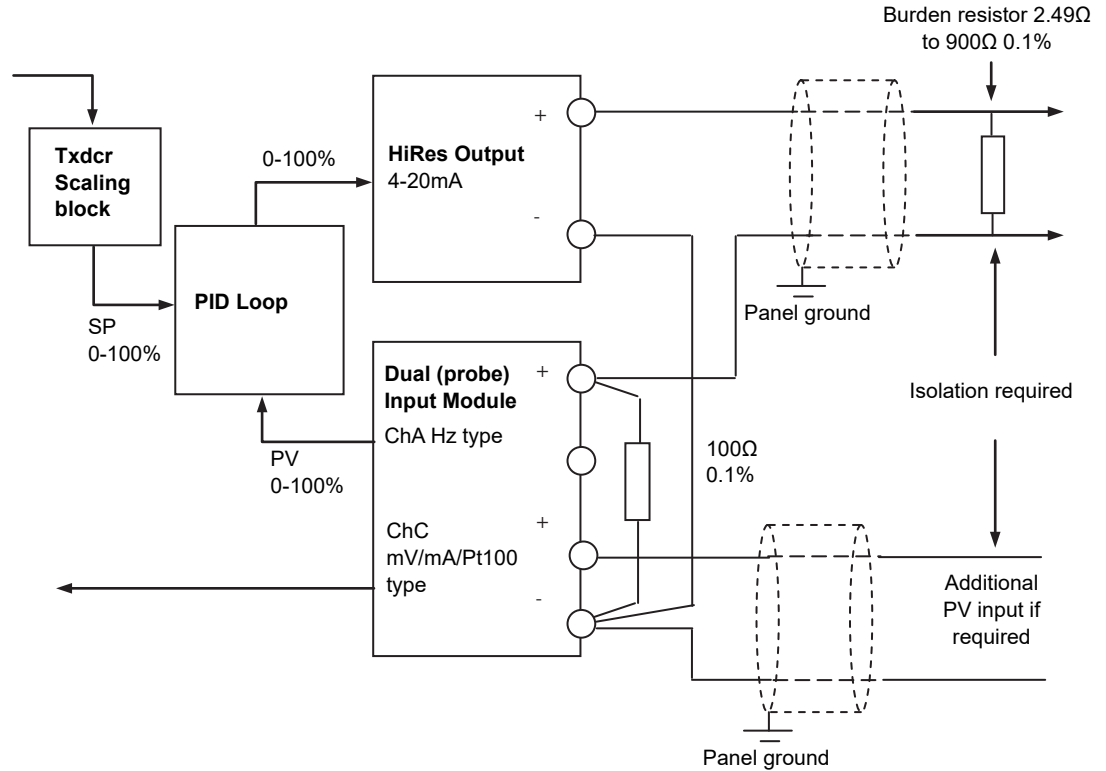

Channel A Input set up:

Elec Lo	0.4V
Elect Hi	2V
Filter time	0.4sec

PID Loop set up

Proportional band (PB)	145%
Integral time (Ti)	0.6sec
Derivative time (Td)	Off

All the internal variables of the loop and their limits are set to 0 –100% range.

Figure 115 Precision 4-20mA Current Loop Retransmission (14bit)



Channel C input and the retransmitted 4-20mA output must be connected together at the (-) terminal of the Dual (probe) input. The receiving instrument 4-20mA input and the other end of the channel C input should be isolated from each other. It is the installers responsibility to ensure the appropriate isolation when using the Dual (probe) module.

Notes:

1. To guarantee that the 4-20mA range is fully covered the channel output is calibrated at 3.8mA (cal low) and 20.5mA (cal High).
2. To utilise the full potential for high accuracy/resolution extra care should be taken to ensure low levels of EM interference as follows:-
 - keep connecting cables away from power cables
 - ground 'Dig Common' of the controller to local panel ground
 - use shielded cables with the shield connected to local panel ground

Precise 0-10V Voltage Retransmission (15bit)

Using a single precision PV input, PSU output and a feedback loop

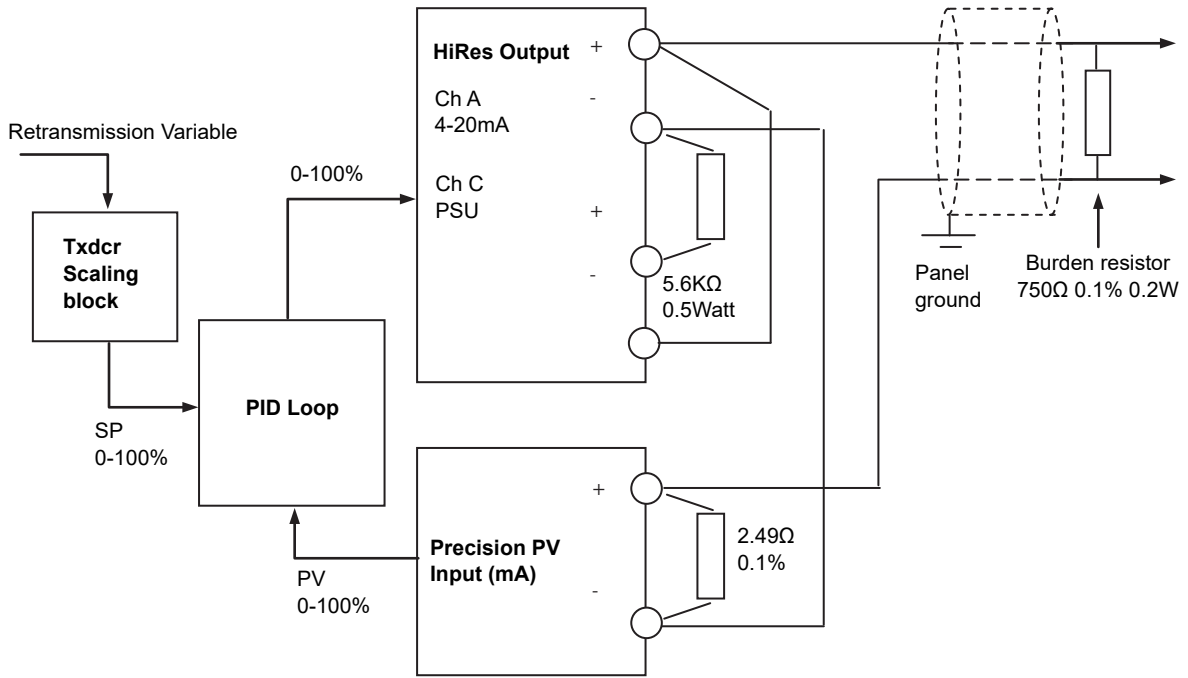

Precision PV Input (mA) set up:

Elec Lo	0mA
Elect Hi	13.333mA
Filter time	0.2sec

PID Loop set up

Proportional band (PB)	125%
Integral time (Ti)	0.4sec
Derivative time (Td)	Off

All the internal variables of the loop and their limits are set to 0 –100% range.

Figure 116 0 – 10V Voltage Retransmission (15bit)

Notes:

1. Range of the retransmitted voltage can be scaled by using different burden resistors:
 - 150Ω will produce 0-2V range
 - 100Ω will produce 0-1.333V range
2. To guarantee that the 4-20mA range is fully covered the channel output is calibrated at 3.8mA (cal low) and 20.5mA (cal High).
3. To utilise the full potential for high accuracy/resolution extra care should be taken to ensure low levels of EM interference as follows:
 - keep connecting cables away from power cables
 - ground 'Dig Common' of the controller to local panel ground
 - use shielded cables with the shield connected to local panel ground

Precise 0-10V Voltage Retransmission (14bit)

Using a Dual (probe) input, PSU output and a feedback loop with input from channel A.

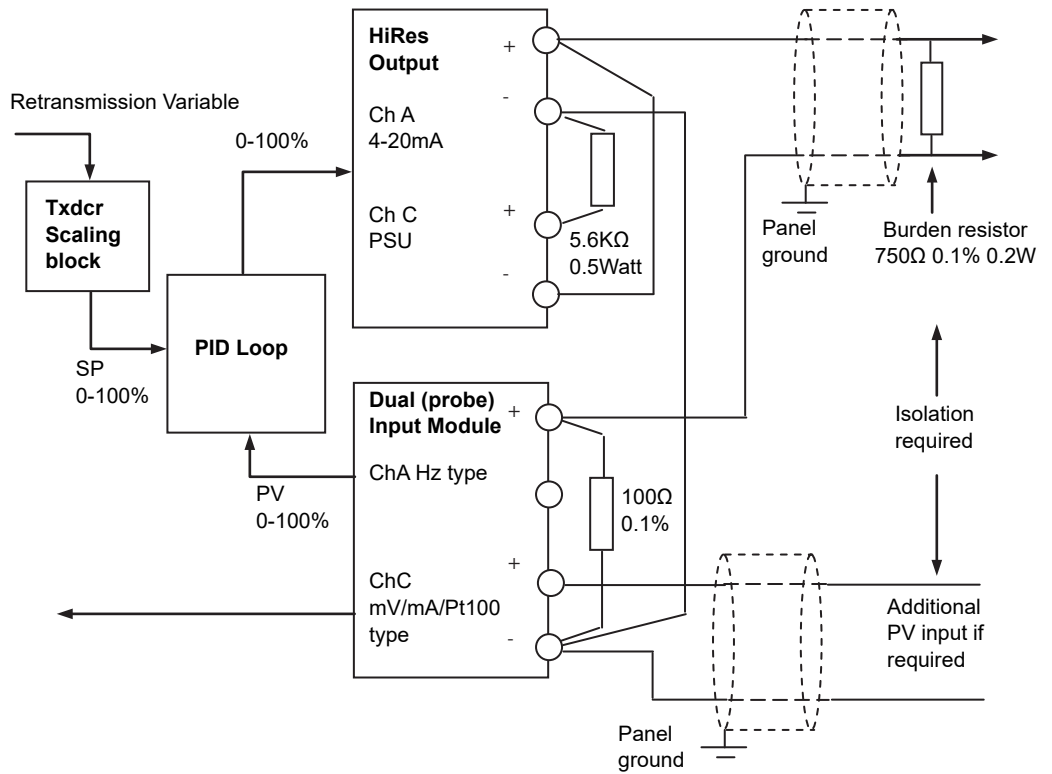

Precision PV Input (mA) set up:

Elec Lo	0V
Elect Hi	13.333mA
Filter time	0.4sec

PID Loop set up

Proportional band (PB)	145%
Integral time (Ti)	0.6sec
Derivative time (Td)	Off

All the internal variables of the loop and their limits are set to 0 –100% range.

Figure 117 Precision 0-10V Voltage Retransmission (14bit)



Channel C input and the retransmitted 4-20mA output must be connected together at the (-) terminal of the Dual (probe) input. The receiving instrument 4-20mA input and the other end of the channel C input should be isolated from each other. It is the installers responsibility to ensure the appropriate isolation when using the Dual (probe) module.

Notes on the previous page apply.

High Resolution Output Module Parameters

Table 107:		This page allows you to set the parameters for a High Resolution Output module. This module can only be fitted in slots 1, 4 and 5.		MODULE IO (Module 4(C) Page)	
Parameter Name	Parameter Description	Value	Default	Access Level	
This module has two outputs. Parameters are displayed under 'channel' (A) and 'channel' (C) Channel A can be 4-20mA output or transmitter PSU, channel C is the PSU.					
Ident	Channel identification	Hi Res Out		R/O	
Channel Type	Output type	mA (not Ch C) Volts		Conf	
Module Status	Module status	See section Dual (Probe) Input Module.		L3	
Channel Name	User defined name for the channel. Select from User Text page, section Instrument User Text Page		Default text	Conf	
The following parameters are shown for Channel Type = mA only					
Wire Src	Source to which the channel is wired	Modbus address		Conf	
Electrical Lo	Electrical low input level	O/P range	4.00 min	L3. See output scaling	
Electrical Hi	Electrical high input level	O/P range	20.00 max		
Eng Value Lo	Low display reading	Disp. range			
Eng Value Hi	High display reading	Disp. range			
Electrical Val	The current electrical value of the output in operation mode	4 to 20mA		R/O L3	
<i>Module 1 (4 or 5)A</i> Val (can be a user defined name).	The current output value in operation mode.	±100.0% -ve values are not used		R/O L3	
Cal state	Allows the module to be calibrated	Idle Cal Low Confirm Go Now Trim O/P Accept Cal High Restore Factory Save	Idle	Conf	
Cal Trim	Output calibration trim Only appears when Cal State = Now Trim O/P			Conf	

TDS Input Module

The TDS module is specific to TDS measurement and provides a hardware interface with a TDS probe. It can be fitted into any module slot except slot 2. A 1KHz ac signal is produced at terminal A with respect to terminal D as earth. The driver sense terminal B and the earth sense terminal C measures the return voltage and automatically compensates for cable resistance and other sources of voltage drop. The module returns Conductance directly produced by the probe as the main variable. The module software provides signal conditioning such as filtering, cable capacitance compensation, over range, calibration and error trapping and diagnostic variable 'Driver O/P' and 'SBrk' flags.

TDS Input Module Parameters

Table 108: This list allows you to set up the parameters for the TDS input module		MODULE IO (Module *A Page) * = 1,3,4,5,6		
Parameter Name	Parameter Description	Value	Default	Access Level
Ident *A	Module type * shows the slot in which the module is fitted	TDS Input		L3
Channel Type	Used to select the probe type	2 elec.Prob 3 / 4 elec.Prob		Conf
Resolution	Display resolution	XXXXX XXXX.X XXX.XX XX.XXX X.XXXX	XXXXX	Conf
SBrk Cond	Sensor break value in mS. Used to set the level that triggers a sensor break. See also Note 1	Off to 99.999mS	Off	L3
SBrk Fallback	Sensor break fallback state	Off Down Scale Up Scale	Off	Conf
Filter Time	Input filter time	Off to 0:10:00.0	0:00:00.1	L3
Module *A Val	The measured conductance * shows the slot in which the module is fitted			L3
Module Status	Module status See section Dual (Probe) Input Module.	OK or message		L3
Cable Offset	Compensation for length of cable capacitance. See next section for further details		0.000 to 99.999	L3
Driver O/P	Percentage usage of the module's driving capabilities for driving TDS probe and its wiring A value >110% causes SBrk			L3
Channel Name	Name for the channel selected from 'User Text'		Default Text	Conf
Cal State	Calibration state See Calibration for further details	Idle Low – O/C High – 22 ohm Confirm Go Abort Restore Factory Save to User	Idle	Conf

Notes:

1. Sensor break detection on the sensing wires is not available. Disconnecting these wires may cause a step change in the read value depending on the length of the wires.
2. Ground or driver wire disconnection can be detected by the near zero conductance reading.

Cable Offset

Cable offset is used to compensate for cable conductance of the installation. It is only important if the desired range of measurements extends to a conductance of less than five times the conductance of the cable.

For example, a typical 60m of 4wire screened cable produces 170uS reading. Therefore, the compensation will only be required if the measured conductance is expected to fall below 1mS.

It is worth noting that the cable compensation is only effective for 2 electrode type probes.

To Calibrate Cable Offset

- Enter 'Configuration' level and select the particular Module Slot where the TDS Module resides. It is a single channel module so the slot number will be followed by letter A.
- Disconnect the wires from the probe at the probe end and short circuit A to B and C to D at that end.

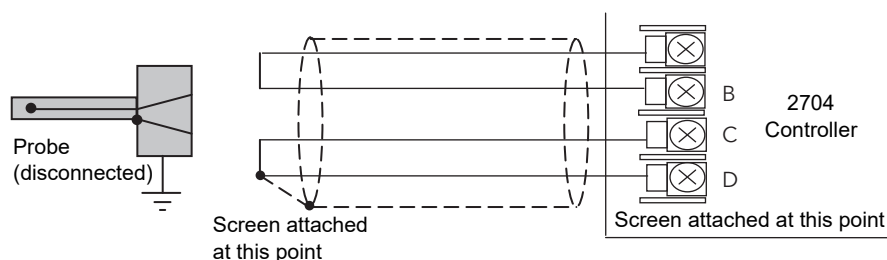

Figure 118 Terminal Connections for Calibration

- Make sure that 'Cable Offset' Compensation parameter is set to 0.000 so that the conductance reading, (Module *A Val) is only due to cable capacitance itself. It may be helpful to make a note of this value.
- Adjust 'Cable Offset' parameter to equal that read by the Module *A Val. Stopping adjustment for more than 2 seconds will activate the compensation.
- Check that the compensated conductance reading is very close to zero. Note that PV noise (i.e. variation in reading) may cause the reading to flip between positive and negative values. On average these should add up to zero. If this is not the case readjust, in small steps, 'Cable Offset' until the above is reached. The noise increase around zero is particularly pronounced if large cable capacitance (20-40nF) is compensated.
- Reconnect the probe.

Module Scaling

The IO modules are scaled as already described in Module IO for the fixed inputs and outputs. The procedures are repeated below:-

The PV Input

Scaling of the PV input applies to linear process inputs, eg linearised transducers, where it is necessary to match the displayed reading to the electrical input levels from the transducer. PV input scaling is not provided for direct thermocouple or RTD inputs.

Figure 119 shows an example of input scaling where an electrical input of 4-20mA requires the display to read 2.5 to 200.0 units.

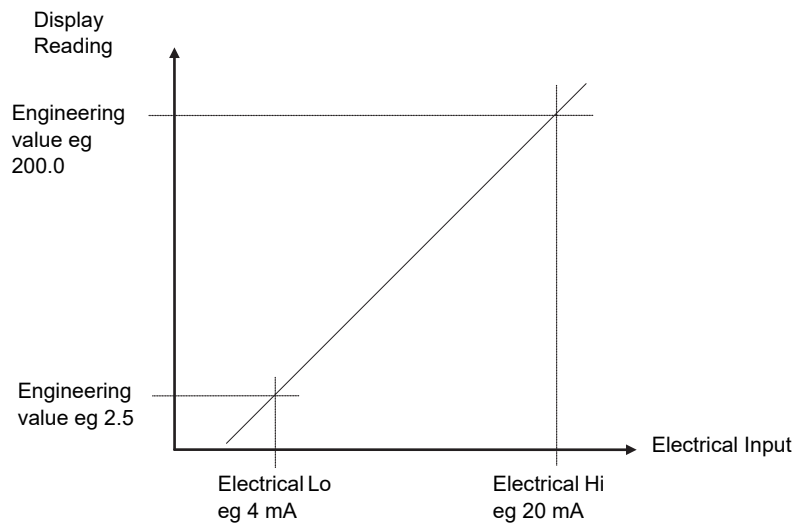



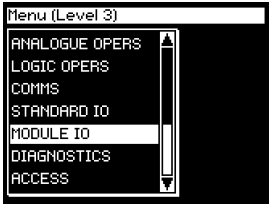



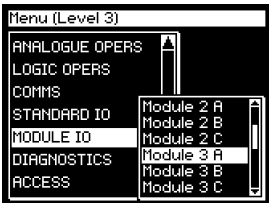





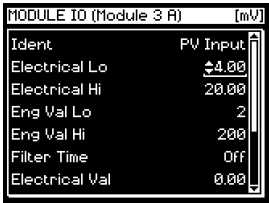



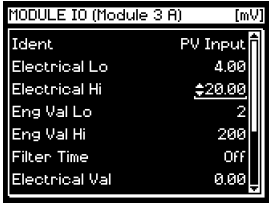



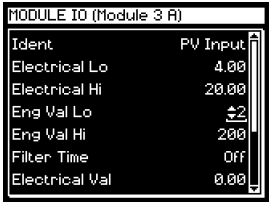



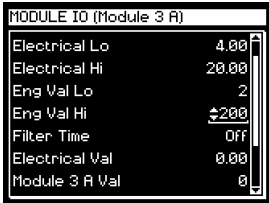

Figure 119 Input Scaling (Modules)

To Scale The PV Input

Do This	This Is The Display You Should See	Additional Notes
<p>1. From any display press  as many times as necessary to access the page header menu</p> <p>2. Press  or  to select 'Module IO'.</p>		
<p>3. Press  to show Sub-headers</p> <p>4. Press  or  to choose the slot in which the PV Input module is fitted</p>		
<p>5. Press  to show the list of parameters.</p> <p>6. Press  or  to scroll to 'Electrical Lo'</p> <p>7. Press  to edit Electrical Lo.</p> <p>8. Press  or  to change the value</p>		<p>Set this value to the lowest level of the input, eg 4mA.</p>
<p>9. Press  to select the 'Electrical Hi'.</p> <p>10. Press  or  to change the value</p>		<p>Set this value to the highest level of the input, eg 20mA.</p>
<p>11. Press  to select the Eng Val Lo.</p> <p>12. Press  or  to change the value</p>		<p>Set up the displayed value (instrument minimum span) which corresponds to the Electrical Lo input, eg 2</p>
<p>13. Press  to select the Eng Val Hi.</p> <p>14. Press  or  to change the value</p>		<p>Set up the displayed value (instrument maximum span) which corresponds to the Electrical Hi input, eg 200.00</p>

Output Modules

If the output module is DC or if it is a relay, triac or logic used as time proportioning control, it can be scaled such that a lower and upper level of PID demand signal can limit the operation of the output value. This is shown in Figure 120 applied to a relay output or any time proportioning output.

By default, the relay will be fully off for 0% power demand, fully on for 100% power demand and equal on/off times at 50% power demand. You can change these limits to suit the process. It is important to note, however, that these limits are set to safe values for the process. For example, for a heating process it may be required to maintain a minimum level of temperature. This can be achieved by applying an offset at 0% power demand which will maintain the relay on for a period of time. Care must be taken to ensure that this minimum on period does not cause the process to overheat

These offsets can be made to parameters in the relevant Module IO pages.

If the output is DC the electrical low and electrical high parameters are analogue values and can be set as in the example given for DC Output Retransmission, section Retransmission Output.

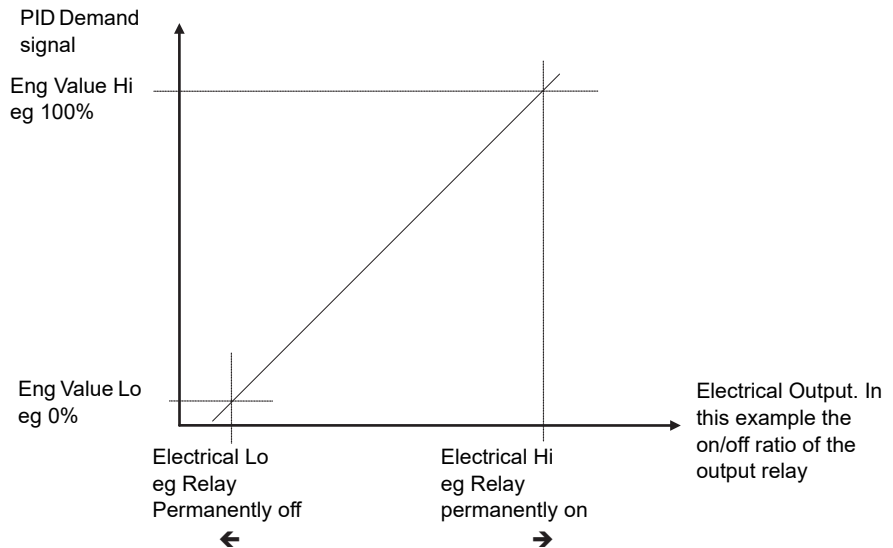







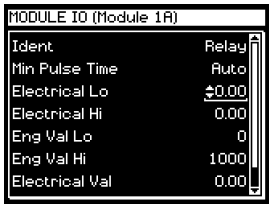





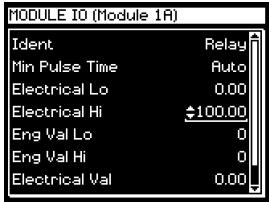



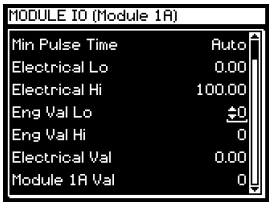



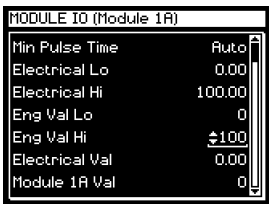

Figure 120 Time Proportioning Relay, Triac or Logic Output

To Scale a Control Output

Do This	This Is The Display You Should See	Additional Notes
1. From the MODULE IO sub-header display, Press  or  to choose the slot in which the Output module is fitted		
2. Press  to show the list of parameters. 3. Press  or  to scroll to 'Electrical Lo' 4. Press  to the Electrical Lo .		Set this to a low value, normally 0. 11. Press  to select the Eng Val Hi . 12. Press  or  to change the value
5. Press  to select the Electrical Hi 6. Press  or  to change the value		Set this to a high value, normally 100.
7. Press  to select the Eng Val Lo . 8. Press  or  to change the value		Set up this value so that the relay (triac or logic) switches fully off corresponding to the Electrical Low setting. If the module is Analogue 0 = 0% output
9. Press  to select the Eng Val Hi . 10. Press  or  to change the value		Set up this value so that the relay (triac or logic) switches fully on corresponding to the Electrical High setting. If the module is Analogue 100 = 100% output

Retransmission Output

The retransmission output can be scaled so that the output value corresponds to range of the signal to be retransmitted.

Figure 121 shows an example where the retransmitted signal is PV or SP and an electrical output of 4-20mA represents 20.0 to 200.0 units.

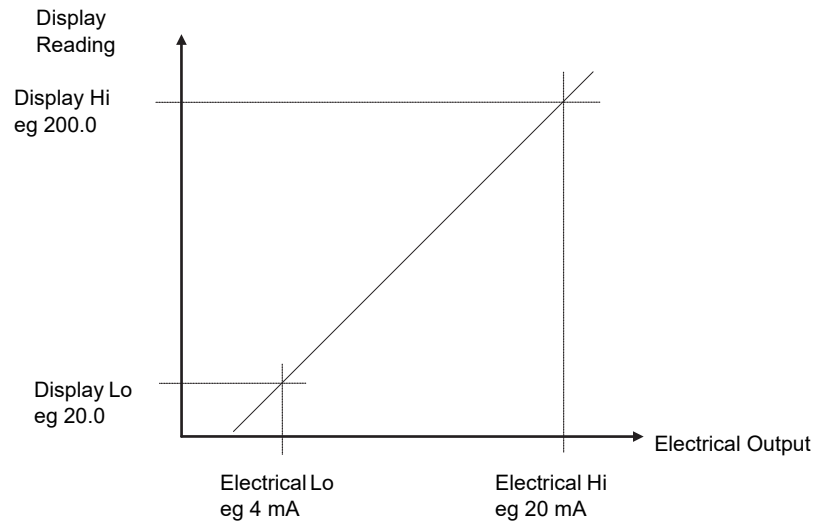

Figure 121 Scaling a Retransmission Output

To Scale a Retransmission Output

The procedure is the same as scaling a Control Output as described in section To Scale a Control Output.

To Scale the Potentiometer Input

When using the controller in bounded valve position control mode, it is necessary to calibrate the feedback potentiometer to correctly read the position of the valve. The value of the potentiometer input is read by the parameter 'Module xA Val', where x is the number of the slot in which the Pot Input module is fitted.

To calibrate the potentiometer input, it is necessary to carry out this procedure in access level 3:

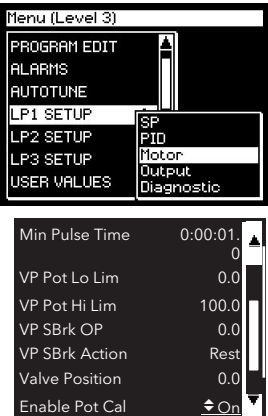
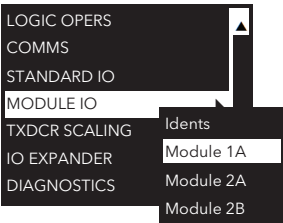
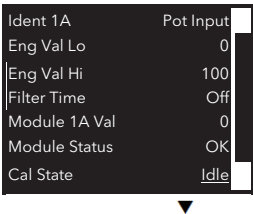
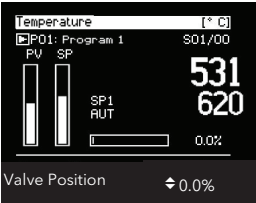
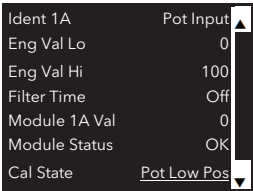
Do This	This Is The Display You Should See	Additional Notes
<ol style="list-style-type: none"> From the relevant LOOP SETUP page header select 'Motor' Press to select Motor Parameters Press or to scroll to 'Enable Pot Cal' Press to select edit Press or to 'On' 	<p style="text-align: center;">Enable Potentiometer Calibration</p> 	<p>LP1 is a user definable name and may be different in your controller</p>
Select the slot in which the Pot Input Module is fitted		
<ol style="list-style-type: none"> Press as many times as necessary to select the page header menu Press or to 'MODULE IO' Press to select the module sub-header list To confirm, press or to select the module in which the Pot Input Module is fitted 		<p>The view shown here is an example and depends upon the functions enabled in the controller</p> <p>This example also assumes the Pot Input Module is fitted in slot 1</p>
Calibrate the Potentiometer Minimum Position		
<ol style="list-style-type: none"> Press to show the Pot Input parameters Press or to scroll to 'Cal State' Press to edit 		<p>'Eng Val Lo' and 'Eng Val Hi' will normally be set to 0 and 100 respectively to represent a fully closed to fully open position of the valve</p> <p>These parameters do not limit the travel of the valve but provide an indication of the pot position</p>
<ol style="list-style-type: none"> Now press to return to an Overview page and select the 'Valve Position' parameter Press to close the valve Press to return to the VP parameters Press or to select 'Pot Low Pos' To confirm, press or to select 'Go'. (You can also select 'Abort' at this point) 	 	<p>To calibrate follow the instructions on the display.</p> <p>When the controller is calibrating the message 'Doing Fine Cal' appears.</p> <p>When the controller has finished the message 'Passed' appears.</p> <p>Press or to 'Accept'. After approx 3 seconds the display will revert to 'Idle' completing the procedure.</p> <p>You can also 'Abort' at this stage.</p>

Calibrate the Potentiometer Maximum Position

Repeat the above steps to adjust the valve fully open and select the parameter '**Pot Hi Pos**'



The Potentiometer Input Module can be used simply so that the resistance value represents an engineering value. For example 35 to 780 mm or 0-1000Ω.

The parameters '**Eng Val Lo**' and '**Eng Val Hi**' are then set to these values.

The procedure to calibrate for these readings is the same as above but, of course, it is not necessary to revert to the Overview display since the potentiometer can be adjusted manually.

When the pot position parameter is highlighted, the units are displayed in the upper right of the display banner.

The units and resolution will have been set in configuration level.

An Out of Range signal will be displayed if the pot measurements lay outside the calibrated range.

Module IO Wiring Examples

To Configure Module 1 Channel A to Run a Program

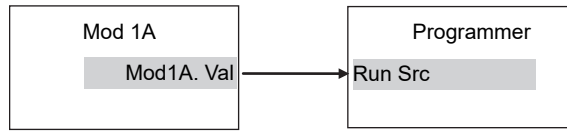

Figure 122 External Run/Hold Switch

This example assumes a Triple Logic module fitted in module slot 1. No configuration of the Module 1A function block is required but the output of the block must be wired to the Run Source in the Programmer block.

Implementation

- | | |
|--|---|
| <ol style="list-style-type: none"> In PROGRAM EDIT/Wiring Page (section PROGRAM EDIT Wiring Page) | <pre>set 'Run Src' = 04148:Mod1A.Val</pre> <p>This connects the output of module 1A to the Run Source wire in the Programmer block.</p> |
|--|---|

To Operate a Relay from a Digital Input

This example assumes that a Relay Module is fitted in module slot 2, and it is required to operate when Digital Input 1 is true.

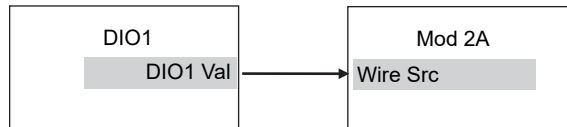

Figure 123 To Operate a Relay from a Digital Input

Implementation

- | | |
|--|--|
| <ol style="list-style-type: none"> In STANDARD IO/Dig IO1 Page (section Standard Digital IO Parameters) | <pre>set 'Channel Type' = Digital Input</pre> <p>This configures DIO1 to be digital input</p> |
| <ol style="list-style-type: none"> In MODULE IO/Module 2 A Page (section Standard IO AA Relay Parameters) | <pre>set 'Channel Type' = On/Off set 'Wire Src' = 05402:DIO1.Val</pre> <p>This configures Module 2A to On/Off relay and connects DIO1 to operate this relay.</p> |

Zirconia Probe Impedance Measurement

The impedance of Zirconia probes can increase with age. The 2704 controller can be used to monitor this impedance using the 'Sensor Break Value' parameter. An alarm on this parameter can be provided if required.

The controller continuously monitors the impedance of a transducer or sensor connected to any analogue input (see also section Sensor Break Value). This impedance, expressed as a percentage of the impedance which causes the sensor break flag to trip, is a parameter called 'SBrk Trip Imp' and is available in the parameter lists associated with both Standard and Module inputs of an analogue nature.

The table below shows the typical impedance which causes sensor break to trip for HZ Volts input and High and Low 'SBrk Impedance' parameter settings.

HZ Volts (-1.5 to 2V)

(applies to Standard PV Input, PV Input module and Dual PV Input module)

SBrk Impedance – High	~ 500KΩ
SBrk Impedance - Low	~ 100KΩ

The graph below shows the approximate relationship between the actual sensor impedance, in ohms, and the measured 'SBrk Trip Imp' parameter, in %, for HZ Volts input type using Standard PV Input, PV Input Module and Dual PV Input module.

Please note that the relationship is not linear, particularly above 30% of the parameter value on High setting. Also that the 'SBrk' reading has a large manufacturing spread and is not factory calibrated. It is recommended, therefore, that the 'SBrk Trip Imp' is calibrated against a known resistor in the range 50 to 100kΩ.

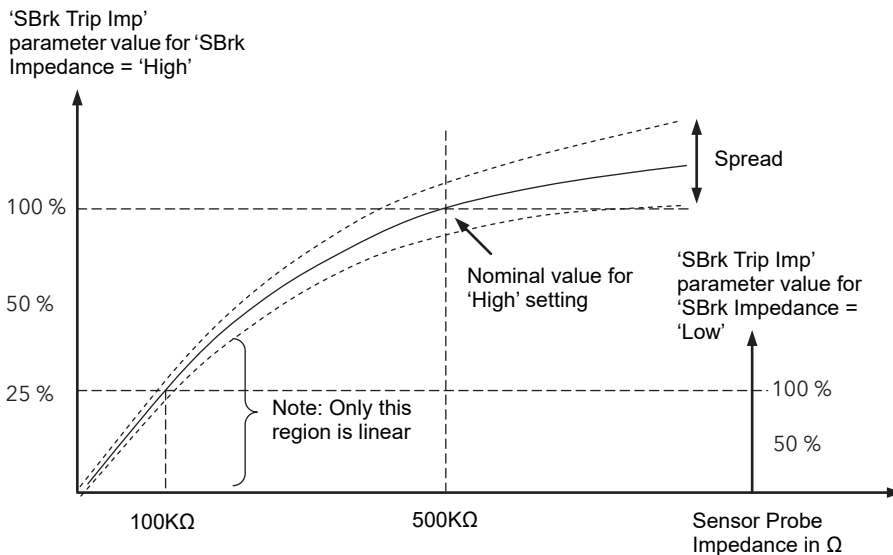

Figure 124 Relationship between sensor impedance and measured impedance

Implementation

This example assumes the Zirconia inputs is connected to the Dual PV Input module, Mod 3.

Analogue Operator 2 acts as a scalar to convert % to a calibrated value of impedance.

User Value 1 is used as a convenient way to calibrate the sensor break value against a known resistor.

Since the signal can be noisy, Analogue Operator 1 acts as a simple filter.

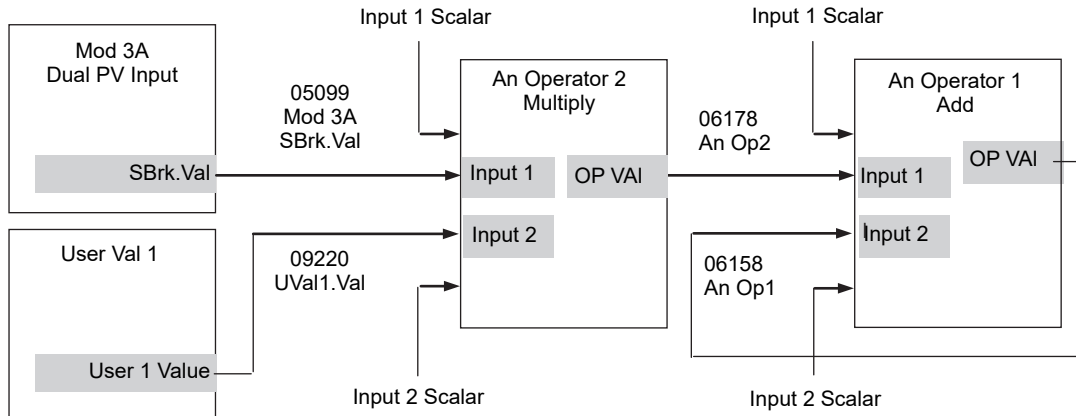

1. In MODULE IO/Module 3A (or 6A) set 'SBrk Impedance' = High
2. In ANALOGUE OPERS/An 2 Page
 - set Operation = Multiply
 - set Input 1 Src = 05099 (Sensor break value)
 - set Input 1 scalar = 1.0
 - set Input 2 Src = 09220 (User value 1 output)
 - set Input 1 scalar = 1.0
3. In ANALOGUE OPERS/An 1 Page
 - set Operation = Add
 - set Input 1 Src = 06178 (Analogue Operator 2 Output value)
 - set Input 1 scalar = 0.01
 - set Input 2 Src = 06158 (Analogue Operator 1 Output value)
 - set Input 1 scalar = 0.99

These settings of input scalar will ensure that the Output Value reaches the same value as Input 1 Value

Calibration

1. Connect a known value of resistor (between 50 and 100kΩ) in place of the probe
2. Adjust User 1 Value so that Analogue Operator 2 Output Value reads the value of the resistor
3. The output from Analogue Operator 2 should ramp to the same value. This value can be promoted to a User Screen or used to provide an alarm.

Transducer Scaling

What is Transducer Scaling?

Transducer scaling is a software function block which provides a method of offsetting the calibration of the controller input when compared to a known input source.

Transducer scaling is often performed as a routine operation on a machine to take out system errors. In the case of a load cell, for example, it may be necessary to zero the scale when a load is removed.

Transducer scaling can be applied to any input or derived input, i.e. the PV Input, Analogue Input or Modules 1, 3, 4, 5, or 6. In practice, however, it is unlikely that transducer scaling would be required on every input and so the 2704 controller includes three transducer calibration function blocks. These can be wired in configuration level to any three of the above inputs.

Four types of calibration are explained in this chapter:

1. Shunt Calibration
2. Load Cell Calibration
3. Comparison Calibration
4. Auto-tare

Shunt Calibration

Shunt calibration is so called since it refers to switching a calibration resistor across one arm of the four wire measurement bridge in a strain gauge transducer. It also requires the use of a Transducer Power Supply.

The strain gauge transducer is calibrated as follows:

1. Remove any load from the transducer to establish a zero reference.
2. Enter 'Scale Low' and 'Scale High' values which are normally set at 0% and 80% of the span of the transducer.
3. Start the procedure using the low point calibration parameter 'Start Pnt1 Cal', or a digital input wired to this parameter.

The controller will automatically perform the following sequence:

1. Disconnect the shunt resistor
2. Calculate the low point calibration value by continuously averaging two lots of 50 measurements of the input until stable readings are obtained
3. Connect the shunt resistor
4. Calculate the high point calibration value by averaging two lots of 50 measurements of the input

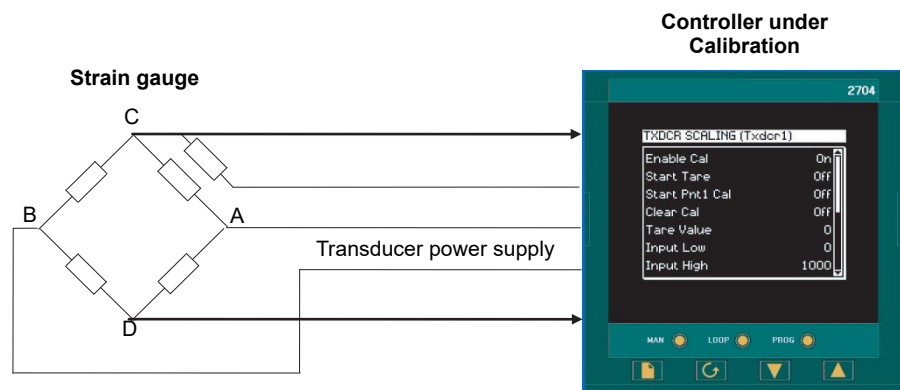





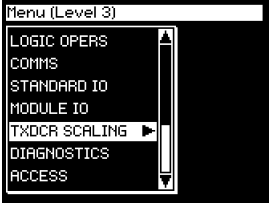



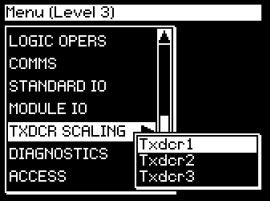

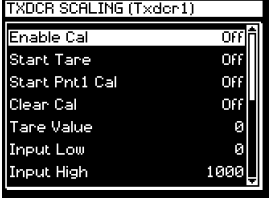



Figure 125 Strain Gauge Calibration

To Calibrate a Strain Gauge Bridge Transducer







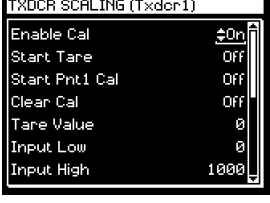



The controller must have been configured for Cal Type = Shunt, and the transducer connected as shown in, Figure 20 using the 'Transducer Power Supply'. Then:

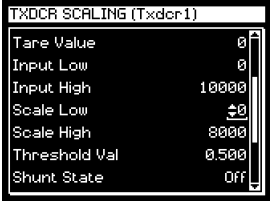

Do This	This Is The Display You Should See	Additional Notes
---------	------------------------------------	------------------

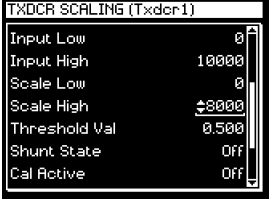
It is first necessary to enable calibration as follows:

<p>1. Press  as many times as necessary to scroll to 'Start Pnt1 Cal'</p> <p>2. Press  or  to select 'TXDCR SCALING'</p>		
<p>3. Press  to show Sub-headers</p> <p>4. Press  or  to select 'Txdcr 1' (or 2 or 3)</p>		<p>The choices are: Txdcr 1 Txdcr 2 Txdcr 3</p> <p>This text can be user defined</p>
<p>5. Press  to show the parameter list</p>		
<p>6. Press  again to select Enable Cal</p> <p>7. Press  or  to On</p>		<p>This parameter remains 'On' once it has been set. It requires to be switched 'Off' manually.</p> <p>It may be wired to an external digital input source such as a key switch</p>

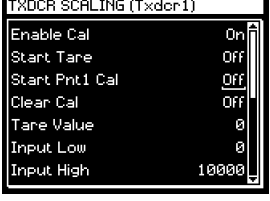
When the Calibration low procedure is complete, place the reference load on the load cell

<p>8. Press  as many times as necessary to scroll to Scale Low</p> <p>9. Press  or  to enter the low end calibration value</p>		<p>This will normally be zero</p>
<p>10. Press  to scroll to Scale High</p> <p>11. Press  or  to enter the high end calibration value</p>		<p>In this example a value of 8000 is chosen which may represent 80% of the 0 -10,000psi range of a pressure transducer.</p>
<p>12. Press  to scroll to Start Pnt 1 Cal</p> <p>13. Press  or  to enter On</p>		<p>This parameter can be configured to be initiated from a digital input and wired, for example, to an external switch.</p> <p>An example of this wiring is given at the end of this chapter</p>

☺ Tip: To backscroll hold down  and press 

The controller automatically performs the procedure described in Section Shunt Calibration. During this time the **Cal Active** parameter will change to **On**. When this parameter value changes back to Off the calibration is complete.

The **Shunt State** parameter will also change during the procedure to show when it is being connected (On = connected, Off = disconnected).

Note: It is possible to start the calibration procedure before the system has settled at a stable value. The controller continuously takes blocks of 50 samples. When the average value between two consecutive blocks is within the **'Threshold Value'** the controller will then calibrate. The Threshold Value defaults to 0.5 but can be adjusted in configuration level. If the readings are not stable within this period the controller will abort the calibration.

Load Cell Calibration

A load cell with V, mV or mA output may be connected to the PV Input, Analogue Input or Modules 1, 3, 4, 5, 6 supplied as analogue inputs. The wiring connections are shown in Installation.

The load cell is calibrated as follows:

1. Remove any load and start the procedure using the low point calibration parameter 'Start Pnt1 Cal', or a digital input wired to this parameter. The controller will calculate the low calibration point
2. Place a reference weight on the load cell and turn on the high point calibration parameter 'Start Pnt2 Cal', or a digital input wired to this parameter. The controller will then calculate the high calibration point.

Note:

If 'Start Pnt1 Cal' = 'On', 'Start Pnt2 Cal' cannot be turned to 'On'.

If 'Start Pnt2 Cal' = 'On', 'Start Pnt1 Cal' cannot be turned to 'On'.

Either must complete before the other can be set to 'On'.

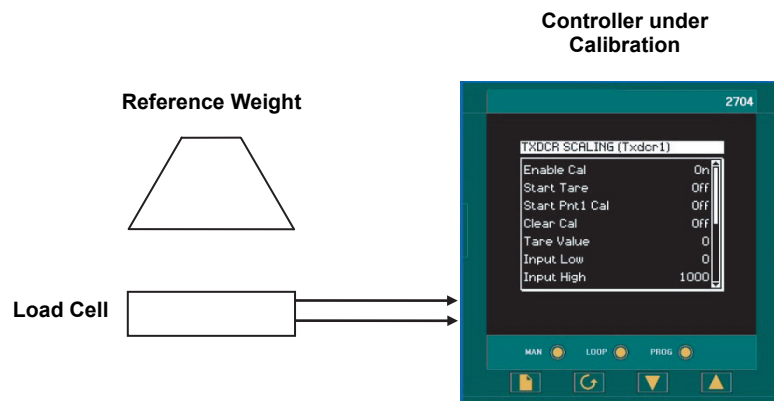



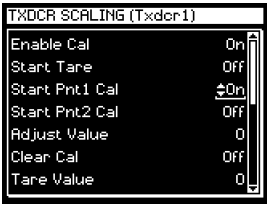





Figure 126 Load Cell Calibration

To Calibrate a Load Cell

The controller must have been configured for Cal Type = Load Cell, and the transducer connected as shown in, Installation. Then:

Do This	This Is The Display You Should See	Additional Notes
<p>Enable calibration as described in steps 1-7 of section To Calibrate a Strain Gauge Bridge Transducer.</p> <p>Then set the load cell to its 'zeroed' condition</p>		
<p>1. Press  as many times as necessary to scroll to 'Start Pnt1 Cal'</p> <p>2. Press  or  to 'On'</p>		<p>This parameter can be configured so that it is activated from a digital input and wired, for example, to an external switch.</p> <p>An example of this wiring is given at the end of this chapter</p> <p>During the time taken for the controller to calculate the low point calibration value, the Cal Active parameter will be On.</p>

When the Calibration low procedure is complete, place the reference load on the load cell

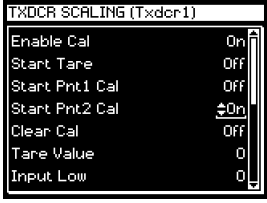
<p>3. Press  to scroll to Start Pnt2 Cal</p> <p>4. Press  or  to On</p>		<p>It can be configured to be initiated from a digital input and wired, for example, to an external switch.</p> <p>An example of this wiring is given at the end of this chapter</p>
--	---	--

Note: 'Scale High' is the high calibration point and 'Scale Low' is the low calibration point. These should be set to the range over which calibration is required. 'Threshold Value' applies as in the previous section.

Comparison Calibration

Comparison calibration is most appropriate when calibrating the controller against a second reference instrument.

In this case the process calibration points are not entered ahead of performing the calibration. The input may be set to any value and, when the system is stable, a reading is taken from the reference measurement device and entered into the controller. The controller stores both this new target value and the actual reading taken from its input.

The process is repeated at a different value, with the controller storing both the new target value and the reading taken from its input.

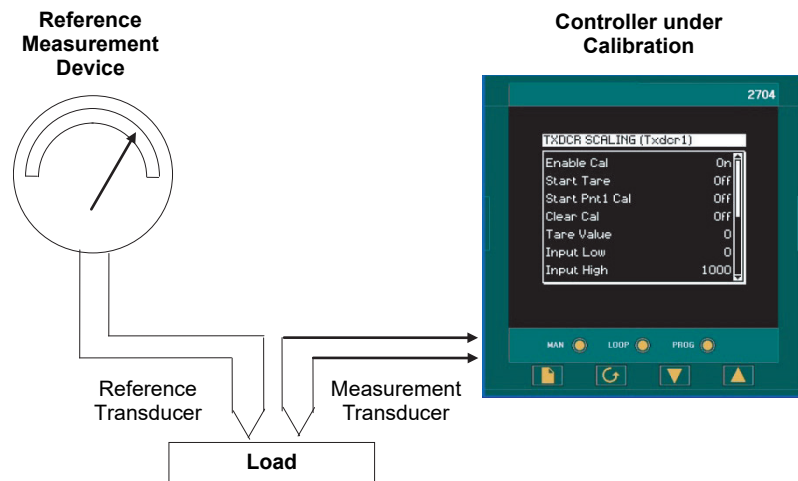
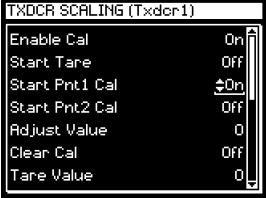
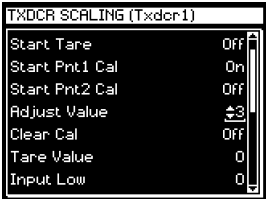
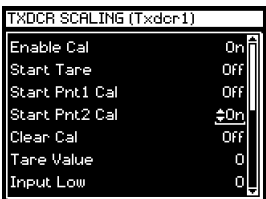
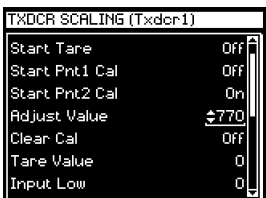

Figure 127 Comparison Calibration

To Calibrate a Controller Against a Second Reference

The controller must have been configured for Cal Type = Comparison, and the transducer connected as shown in the User Guide Installation. Then:

Do This	This Is The Display You Should See	Additional Notes
<p>Enable calibration as described in steps 1-7 of section To Calibrate a Strain Gauge Bridge Transducer.</p>		
<p>Then allow the process to settle at the low calibration point</p>		
<ol style="list-style-type: none"> 1. Press as many times as necessary to scroll to 'Start Pnt1 Cal' 2. Press or to 'On' 		<p>This parameter can be configured to be activated from a digital input and wired, for example, to an external switch.</p> <p>An example of this wiring is given at the end of this chapter</p>
<ol style="list-style-type: none"> 3. Press as many times as necessary to scroll to 'Adjust Value' 4. Press or to enter the value indicated on the reference instrument 5. Press to confirm or to cancel as instructed 		<p>The confirm message does not appear unless 'Adjust Value' is changed.</p> <p>If the displayed value is acceptable change it momentarily then back to the value to step to the next stage.</p> <p>On confirm the current input value is stored as 'Input Low' and the value entered by the user is stored in the 'Scale Low' parameter.</p>
<p>Allow the Process to settle at the high calibration point</p>		
<ol style="list-style-type: none"> 6. Press to 'Start Pnt2 Cal' 7. Press or to 'On' 		<p>This parameter can be initiated from a digital input and wired, for example, to an external switch.</p> <p>An example of this wiring is given at the end of this chapter</p>
<ol style="list-style-type: none"> 8. Press as many times as necessary to scroll to 'Adjust Value' 9. Press or to enter the value indicated on the reference instrument 10. Press to confirm or to cancel as instructed 		<p>The confirm message does not appear unless 'Adjust Value' is changed.</p> <p>If the displayed value is acceptable change it momentarily then back to the value to step to the next stage.</p> <p>On confirm the current input value is stored as 'Input High' and the value entered by the user is stored in the 'Scale High' parameter.</p>

It is possible to perform either low or high points in isolation, or to calibrate both points consecutively as described above.











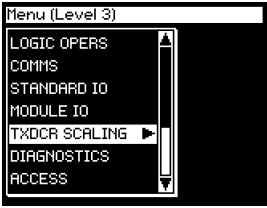

Auto-Tare Calibration

The auto-tare function is used, for example, when it is required to weigh the contents of a container but not the container itself.

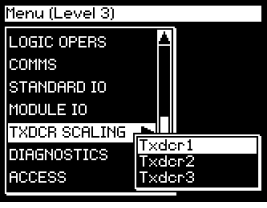

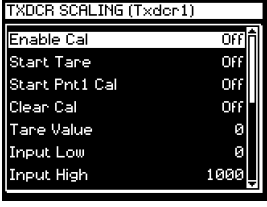

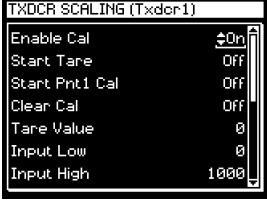

The procedure is to place the empty container on the weigh bridge and 'zero' the controller. Since it is likely that following containers may have different tare weights the auto-tare feature is always available in the controller at access level 1.

To Use the Auto-Tare Feature

Firstly, access the transducer scaling parameters as follows:-

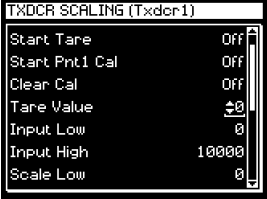
Do This	This Is The Display You Should See	Additional Notes
1. From any display press  as many times as necessary to access the page header menu 2. Press  or  to select 'TXDCR SCALING'		
3. Press  to show Sub-headers 4. Press  or  to select 'Txdcr 1' (or 2 or 3)		The choices are: <i>Txdcr 1</i> <i>Txdcr 2</i> <i>Txdcr 3</i> This can be user defined text
5. Press  to show the parameter list		
6. Press  again to edit Enable Cal 7. Press  or  to On (if necessary)		This parameter remains 'On' once it has been set. It requires to be switched 'Off' manually. It may be wired to an external digital input source such as a key switch.

The auto-tare calibration is then as follows:

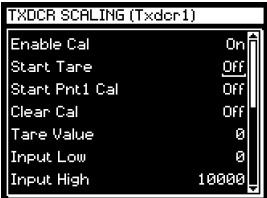
Do This	This Is The Display You Should See	Additional Notes
Set the equipment at the normal tare point, eg place the empty container on the weigh bridge		
1. Press  to 'Tare Value' 2. Press  or  to enter the required value		This will normally be zero. When once set it will only be necessary to access this parameter again if a new tare value is required.
3. Press  as many times as necessary to scroll to 'Start Tare' 4. Press  or  to 'On'		This parameter can be initiated from a digital input and wired, for example, to an external switch. An example of this wiring is given at the end of this chapter.

The effect of auto-tare is to introduce a DC bias to the measurement, as shown in Figure 128 below.

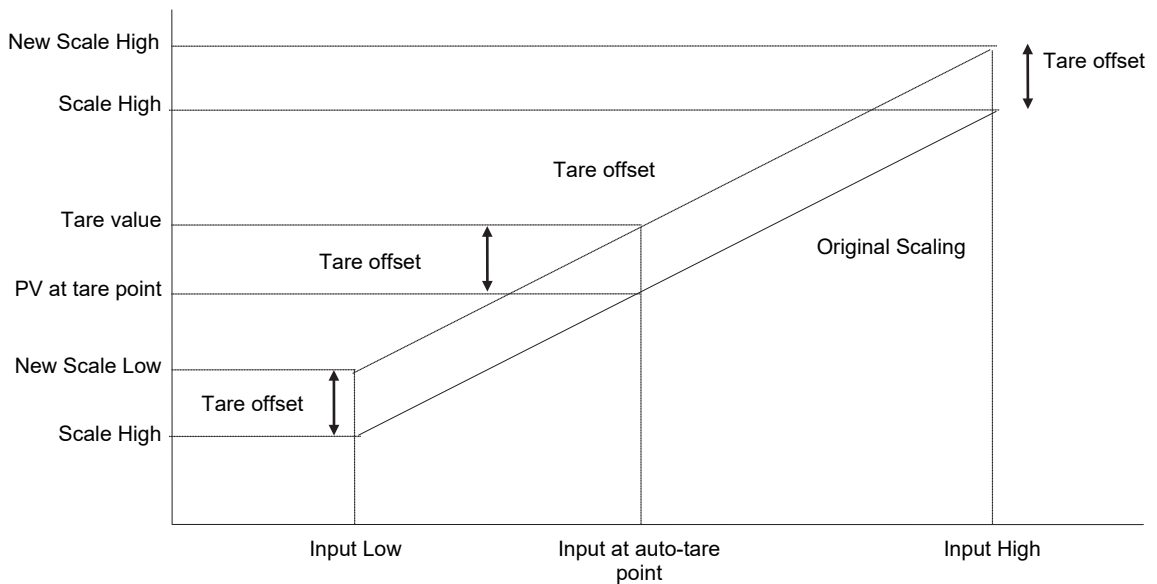

Figure 128 Effect of Auto-Tare

Note: A Tare calibration will change the values of 'Scale High' and 'Scale Low'.

Transducer Scaling Parameters

The parameters listed in the table below allow you to soft wire to sources within the controller to provide, for example, operation of calibration procedure via external switches.

Transducer Scaling Parameter Table

Table 109: This page shows the Transducer Scaling parameters.		TXDCR SCALING (Txdcr 1)		
Parameter Name	Parameter Description	Value	Default	Access Level
Cal Type	Type of calibration	Off Shunt Load Cell Comparison	Off	Conf
Input Src	Pre-scaled value source	Modbus Address	None	Conf
Enable Cal Src	Enable calibration source			Conf
Clear Cal Src	Clear calibration source			Conf
Start Pnt 1 Src	Start calibration point 1 source			Conf
Start Pnt 2 Src	Start calibration point 2 source			Conf
Start Tare S	Start auto tare calibration source			Conf
Range Min	Minimum scale value			Conf
Range Max	Maximum scale value			Conf
Txdcr Name	Transducer name	From User Text	Default Text	Conf
Enable Cal ⁽¹⁾	Enable calibration	Off On	Off	L3
Start Tare ⁽²⁾	Start auto-tare calibration	Off On	Off	L1
Start Pnt1 Cal ⁽³⁾	Start the calibration at point 1, normally the low point	Off On	Off	L1
Start Pnt2 Cal ⁽⁴⁾	Start the calibration at point 2, normally the high point	Off On	Off	L1
Clear Cal ⁽⁵⁾	Clear previous calibration values	Off On	Off	L3
Tare Value	Sets the value that the controller will read after an auto-tare calibration	Display range		L3
Input Low	Sets the scaling input low point			L3
Input High	Sets the scaling input high point			L3
Scale Low	Sets the scaling output low point			L3
Scale High	Sets the scaling output high point			L3
Threshold Val ⁽⁶⁾	The allowed difference between two consecutive averages during calibration	0 - 99.999 mins		L3
Shunt State ⁽⁷⁾	Indicates that the shunt resistor is connected or not	Off On		L3 R/O
Cal Active	Indicates calibration in progress	Off On		L3 R/O
Input Value	Pre-scaled input value	-100 to 100	0	L1
Scaled Value	Output from the scaling block.			R/O
Adjust Value	Sets the value read by the reference source in comparison calibration only			L1
OP Status	Output status based on input status and scaled PV	Good Bad		R/O

Parameter Notes

1. Enable Cal
This may be wired to a digital input for an external switch. If not wired, then the value may be changed.
When enabled the transducer parameters may be altered as described in the previous sections. When the parameter has been turned On it will remain on until turned off manually even if the controller is powered cycled.
2. Start Tare
This may be wired to a digital input for an external switch. If not wired, then the value may be changed.
3. Start Pnt1 Cal
This may be wired to a digital input for an external switch. If not wired, then the value may be changed.
It starts the calibration procedure for:
 1. Shunt Calibration
 2. The low point for Load Cell Calibration
 3. The low point for Comparison Calibration
4. Start Pnt2 Cal
This may be wired to a digital input for an external switch. If not wired, then the value may be changed.
It starts the calibration procedure for:
 1. The high point for Load Cell Calibration
 2. The high point for Comparison Calibration
3. Clear Cal
This may be wired to a digital input for an external switch. If not wired, then the value may be changed.
When enabled the input will reset to default values. A new calibration will overwrite the previous calibration values if Clear Cal is not enabled between calibrations.
4. Threshold Val
The input needs to settle within a range which has been set in configuration level. The threshold value sets the required settling time for shunt, load cell and auto-tare calibration.
5. Shunt
This parameter is an output from the function block which can be wired to a transducer scale module to close the shunt circuit and introduce the calibration resistor. It may be used in copy and paste wiring.

IO Expander

What is IO Expander?

Note: I/O Expander is not supported beyond products with a product status level (PSL) equal to 'B5' and above. The status level is specified on the serial number which can be found on the label fitted to the side of the controller - Serial No: PL2107001772-072- S9 ('S' denotes the software status and changes alphabetically and '9' denotes hardware status and increments).

The IO Expander is an external unit which can be used in conjunction with the 2704 controller to allow the number of digital IO points to be increased. There are two versions:-

1. 10 Inputs and 10 Outputs
2. 20 Inputs and 20 Outputs

Each input is fully isolated and voltage or current driven. Each output is also fully isolated consisting of four changeover contacts and six normally open contacts in the 10 IO version and four changeover and sixteen normally open contacts in the 20 IO version.

Data transfer is performed serially via a two wire interface as shown in Figure 129.

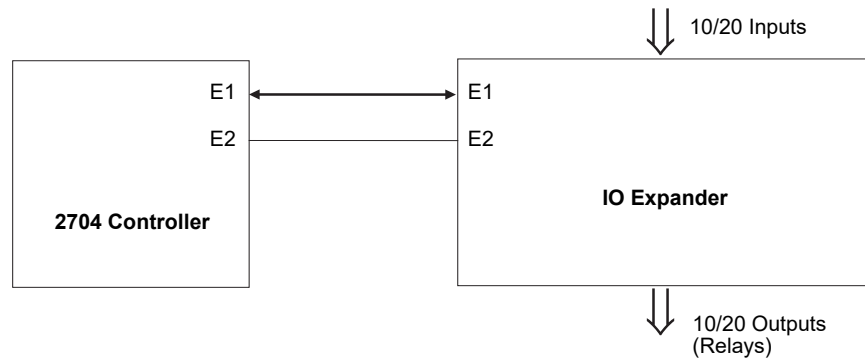

E1 and E2 are the terminal numbers on both Controller and IO Expander. It is recommended that a cable length of 10 metres is not exceeded, however, no shielding or twisted pair cable is required.

Figure 129 IO Expander Data Transfer

Wiring connections are shown in section I/O Expander (or Additional Digital Input) and further details of the IO Expander are given in the IO Expander Handbook, Part No. HA026893.

When this unit is connected to the controller it is necessary to set up parameters to determine its operation. These parameters can be set up in Operation Level 3 and are repeated here for information.

The IO Expander is enabled in INSTRUMENT/Options Page, see section Instrument Options Page.

To Configure IO Expander

Do This	This Is The Display You Should See	Additional Notes
1. From any display press as many times as necessary to access the page header menu 2. Press or to select ' IO EXPANDER '		
3. Press to show the parameter list 4. Press or to scroll to the required parameter 5. Press to select the parameter 6. Press or to change the value or state		In this view the IO Expander type has been configured as 10 In and 10 Out and parameter ' OP 1 Src ' has been connected to the ' Totaliser 1 Alarm Output '. The IO Expander output 1 will operate when Totaliser 1 alarm output is exceeded.

Remaining parameters in the Analogue Operators list are accessed and adjusted in the same way.

The list of parameters available is shown in the following table ↓↓

Instrument Options Page

Table 110: This page allows you to configure the IO Expander.			IO EXPANDER	
Parameter Name	Parameter Description	Value	Default	Access Level
Expander Type	Expander type	None 10 in 10 out 20 in 20 out	None	Conf
OP 1 Src	Output 1 source Source of the signal to operate relay 1 in the IO Expander.	Modbus address		Conf
The above parameter is repeated for all 20 outputs available in the IO Expander				
Status	IO Expander status	Good Bad		L1 R/O
In Stat 1-10	Status of the first 10 digital inputs □□□□□□□□□□ to ■■■■■■■■■■	□ = Off ■ = On		L1 R/O
In Stat 11-20	Status of the second 10 digital inputs □□□□□□□□□□ to ■■■■■■■■■■	□ = Off ■ = On		L1 R/O
OP Stat 21-30	Status of the first 10 digital outputs. Press to select outputs in turn. The flashing underlined output can be changed using buttons. □□□□□□□□□□ to ■■■■■■■■■■	□ = Off ■ = On		L1
OP Inv 1-10	To change the sense of the first 10 outputs.	□ = direct ■ = Inverted		L3
Out Stat 31-40	Status of the second 10 digital outputs. Press to select outputs in turn. The flashing underlined output can be changed using buttons. □□□□□□□□□□ to ■■■■■■■■■■	□ = Off ■ = On		L1
OP Inv 31-40	To change the sense of the second 10 outputs.	□ = direct ■ = Inverted		L1

Diagnostics

What are Diagnostics?

Diagnostics are displayed in Access Level 3 and Configuration level, and provide information on the internal state of the controller. The parameters are intended for use in advanced fault finding situations. Up to eight error messages can be listed and each error message displays a message showing the state of the controller. The error messages are shown in Note 1.

The diagnostic parameters are listed below:-

Diagnostics Parameters

Table 111: This page allows you to inspect diagnostic information		DIAGNOSTICS		
Parameter Name	Parameter Description	Value	Default	Access Level
Error Count	Number of errors recorded			Read only
Error 1	Historical errors where 1 is the most recent	See Note 1		Read only
Error 2				
Error 3				
Error 4				
Error 5				
Error 6				
Error 7				
Error 8				
Clear Err Log?	Error log reset	No Yes	No	Conf
CPU % Free	A measure of the loading on the CPU			Read only
Con Task Ticks	A measure of the activity of the algorithm			Can be written to in L3 and Conf
UI Task 1 Ticks				
UI Task 2 Ticks				
Power FF	Power feedback. Measures the supply voltage to the controller			Read only
Power Failures	A count of the number of power failures			Read only
Battery Low	Read only warning that the battery is low and MUST be changed at the very earliest opportunity. This is accompanied by a low battery warning message which is displayed at power up and every 24 hours (approximately) after that. When battery low status is detected an error is placed in the error log, triggering an error log message such as that shown in Note 1. This message applies to instruments fitted with firmware versions 6.60 and above. See also the section Battery Low Warning Message at the front of this manual.	No Yes		Read only
Num Free Segs	Shows the number of segments available for use in the programmer			Read only
Program Number				

Note 1.

Possible error messages:-

OK	SPI Locked
Bad Ident	SPI Queue Full
Bad Fact Cal	HighP Lockout
Module Changed	Pro Mem Full
DFC1 Error, DFC2 Error, DFC3 Error	Invalid Seg
Module N/A	Program Full
CBC Comms Error	Invalid Prog
Cal Store Error	Bad Logic 1 to Bad Logic 7
CBC Cal Error	CPU Add Err
Bad PV Input	Calc CRC Err
Bad Mod3 Input, Bad Mod4 Input, Bad Mod6 Input,	Bad Cal Restore
Bad An Input	Bad Cust Lin
Bad NVOL Check	Bad Instruct
Bad X Board	Bad Slot Instr
Bad Res Ident	DMAAddr Err
Bad SPI SemRel	Reserved Int
Bad CW EETrans	Undefined Int
Bad Prog Data	SPC Init Err
Bad Prog Csum	H Rx Timeout
SegPool Over	J Rx Timeout
Bad Cust Lin	Customer linearisation incorrect
Batt Low Err	Battery low

Calibration

The 2704 controller is calibrated in three ways. These are:-

1. **Factory Calibration.** The controller is calibrated to very high accuracy during manufacture and the calibration values are permanently stored within the controller. Factory calibration is not available to the user, but it is always possible to revert to the factory values if required.
2. **Transducer Scaling.** This is described in Transducer Scaling allows offsets to be entered to compensate for errors or differences in the process measurement system.
3. **User Calibration.** This allows the instrument to be calibrated against a certified field calibration source. This chapter describes User Calibration.

User Calibration

The following inputs can be calibrated:

1. **PV Input.** This is the fixed PV input on terminals VH, V1, V+, V-. The PV Input can be configured for Thermocouple, Platinum Resistance Thermometer (RTD), Pyrometer, mV, Volt, High Impedance Input Volts or mA inputs. Pyrometer and mA ranges are included in the mV range. Thermocouple calibration involves calibrating the temperature offset of the CJC sensor only. Other aspects of thermocouple calibration are also included in mV calibration.
2. **Analogue Input.** This is the fixed input on terminals BA, BB, BC, and is intended for volt or current sources.
3. **Analogue I/O Modules.** These are inputs which can be connected to terminals A, B, C, D of the module I/O. Any input type listed above can be connected to these modules.

See also the 'Installation' chapter in the User Guide for details on terminal connections.

Precautions

The following inputs can be calibrated:

Before starting any calibration procedure the following precautions should be taken:-

1. When calibrating mV inputs make sure that the calibrating source outputs less than 250mV before connecting it to the mV terminals. If accidentally a large potential is applied (even for less than 1 second), then at least one hour should elapse before commencing the calibration.
2. RTD calibration is incomplete without mV calibration. A strict procedure, presented in section 3-Wire RTD Calibration. must be followed to avoid calibration errors being up to an order of magnitude greater than that specified for this input. This particularly concerns the linearity specification.

A pre-wired jig built using a spare instrument sleeve may help to speed up the calibration procedure especially if a number of instruments are to be calibrated. This can be built using a spare instrument sleeve available by quoting Part No. SUB26/SLE.

It is very important that power is turned on only after the controller has been inserted in the sleeve of the pre-wired circuit. Power should also be turned off before removing the controller from its sleeve.

Allow at least 10 minutes for the controller to warm up after switch on.

Failure to observe these precautions will result in the controller not being calibrated to its full capability.

PV Input

To Calibrate mV Range



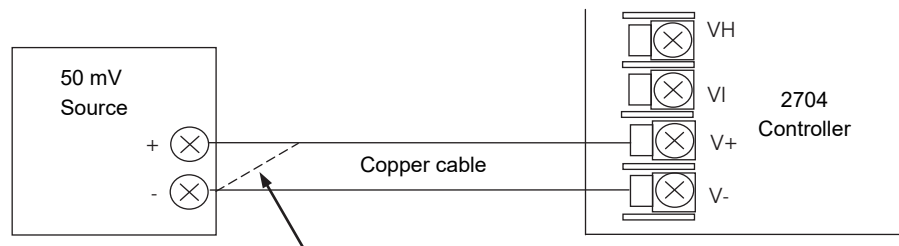









Calibration of both 40 and 80 mV ranges for the PV Input is carried out using the same 50 milli-volt source. Pyrometer and mA calibration is included in this procedure. To calibrate thermocouples it is first necessary to calibrate the 40mV and 80mV ranges followed by CJC described in section Thermocouple Calibration.

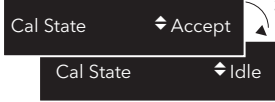

For best results 0mV should be calibrated by disconnecting one of the copper wires from the mV source and short circuiting it to the other wire. This is particularly important to obtain best accuracy for RTD calibration

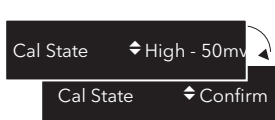
Figure 130 Connections for mV Range

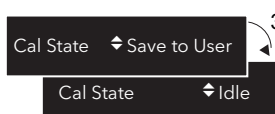









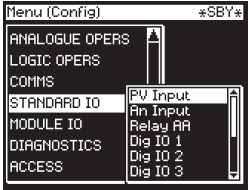

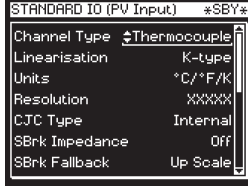

Do This	This Is The Display You Should See	Additional Notes
1. From any display press as many times as necessary until the 'STANDARD IO' page header is displayed. 2. Press to select sub-headers and 'PV Input'		To choose PV Input
3. Press to select the parameter list 4. Press again to select 'Channel Type' 5. Press or to choose the 40mV or 80mV range		To choose mV input range
6. Press until the parameter 'Cal State' is displayed		

Do This	This Is The Display You Should See	Additional Notes
Calibrate at 0mV		
7. Set mV source to 0mV (or better by linking the two copper wires as described in the previous section)		
8. Press  to choose 'Low - 0mV'		<p>Calibration commences 3 seconds after (Go) is selected and 4 seconds later progresses to 'Passed'.</p> <p>If the message Failed appears this usually indicates that the input is not connected.</p>
9. Press  to choose 'Go'		<p>At any point in this process press  to select Abort.</p>
10. Press  to choose 'Accept'		<p>3 seconds after selecting 'Accept' the 0mV calibration becomes valid</p> <p>Alternatively press  to 'Abort'</p>
Calibrate at 50mV		
11. Set mV source to 50mV		
12. Press  to choose 'High - 50mV'		
13. Repeat steps 9 & 10		
<p>At this point the new calibration values are used by the controller. They will, however, be lost when the power to the controller is turned off. Complete the following step to store the values to the User Calibration area.</p>		
14. Press  or  to choose 'Save to User'		<p>3 seconds after selecting 'Save to User' the 0mV and 50 mV calibration values are stored and used by the controller.</p> <p>To return to factory calibration press  to 'Restore Factory', then choose 'Save to User'</p>

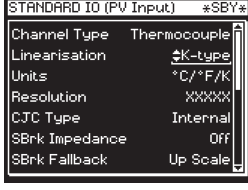
Thermocouple Calibration

Thermocouples are calibrated, firstly, by following the previous procedure for the 40mV and 80mV ranges, (both ranges should be calibrated to cover all types of thermocouple) then calibrating CJC.

This can be carried out using an external CJC reference source such as an ice bath or using a thermocouple mV source. Replace the copper cable shown in Figure 130 with the appropriate thermocouple compensating cable. Set the mV source to internal compensation for the thermocouple in use and set the output for 0mV. Then:-

Do This	This Is The Display You Should See	Additional Notes
1. Access the PV Input sub-header from STANDARD IO menu as described in the previous section		To choose PV Input
2. Press  to show the parameter list. 3. Press  again to select 'Channel Type' 4. Press  or  to choose 'Thermocouple'		To choose input type.
5. Press  to select 'Linearisation' 6. Press  or  to choose the linearisation curve for the thermocouple in use		To choose thermocouple linearisation curve Ensure that 'Rear Term Temp' is set to 'Auto'. If not it will be necessary to accurately measure the temperature at the rear terminals and set this value accordingly
7. Press  until the parameter 'Cal State' is displayed		
8. Press  or  to choose 'CJC'		Press  to 'Go'. Then Accept and Save to User as described in Section To Calibrate mV Range steps 10 and 14.

Voltage Calibration

The procedure is identical to mV calibration with the exception that the low calibration point is 0V and the high point is 8V.

Note: The voltage input terminals are VH and V- as detailed in the User Guide.

High Z Voltage Calibration

The procedure is identical to mV calibration with the exception that the low calibration point is 0V and the high point is 1V.

Note: The voltage input terminals are VH and V- as detailed in the User Guide.

3-Wire RTD Calibration

The two points at which RTD is calibrated are 150.00Ω and 400.00Ω.

Before starting RTD calibration:

- A decade box with total resistance lower than 1K must be connected in place of RTD as indicated on the connection diagram **before the instrument is powered up**. If at any instant the instrument was powered up without this connection then at least 1 hour must elapse from the time of restoring this connection before RTD calibration can take place.
- The instrument should be warmed up (powered up) for at least 10 minutes.

Before using or verifying RTD calibration:

- The above two points must be satisfied if the full accuracy is to be expected – see Note 2.
- The mV ranges must be calibrated – particularly the 0mV point. RTD calibration is incomplete without accurately calibrated mV ranges. Each instrument (or module) is calibrated to high standard in factory before shipment, therefore, the user does not need to perform mV calibration. If for any reasons this calibration was altered then 'Restore Factory' calibration and 'Save' facilities of mV ranges can be used. If on the other hand the RTD linearity is of a particular importance and the mV calibration was not checked/performed for several years than see Note 1.

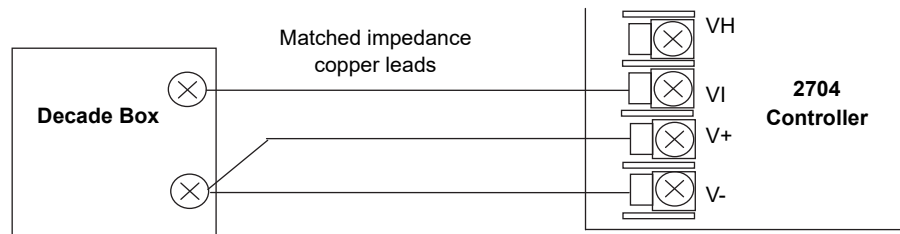
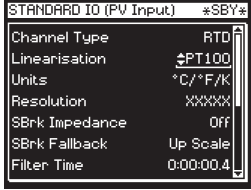

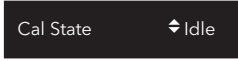



Figure 131 Connections for RTD

Notes:

1. Proceed with mV calibration as described in section To Calibrate mV Range making sure that 0mV is calibrated by short-circuiting the connecting copper wires and the same 50 mV source is used to calibrate high point on both 40 and 80 mV ranges. Also the calibration of both mV range should take place within short period of each other. As mV calibration requires disconnecting RTD or decade box it may be quicker to do RTD calibration first. However, do remember about 1-hour delay before being able to verify the calibration.
2. Typical extra errors to expect: ~0.5°C within the first minute, ~0.2°C within first 15 minutes, ~0.1°C within first 1 hour.

Do This	This Is The Display You Should See	Additional Notes
1. For a controller calibrated for RTD type PT100, the view on the display should be as shown.		
2. Press  until the parameter 'Cal State' is displayed		
3. Set the decade box for 150.00Ω 4. Repeat procedure 25.3.1. steps 9 to 10	<p style="text-align: center;">Calibrate at 150 ohms.</p> 	
5. Set the decade box for 400.00Ω 6. Repeat procedure 27.3.1. steps 11 to 14	<p style="text-align: center;">Calibrate at 400 ohms.</p> 	'Doing Fine Cal' for RTD takes about 30 seconds. This is about seven times longer than when calibrating mV

Analogue Input

Calibration of the Analogue input is carried out using an 8 volt ($\pm 2\text{mV}$) source. mA calibration is included in Volt calibration and assumes 100Ω burden resistor across terminals BA & BB.

There are three conditions to be calibrated - **Offset, Common Mode Rejection and Gain.**

The use of a pre-wired jig is recommended assuming that all three conditions are to be calibrated. The connections for this are shown in Figure 132.

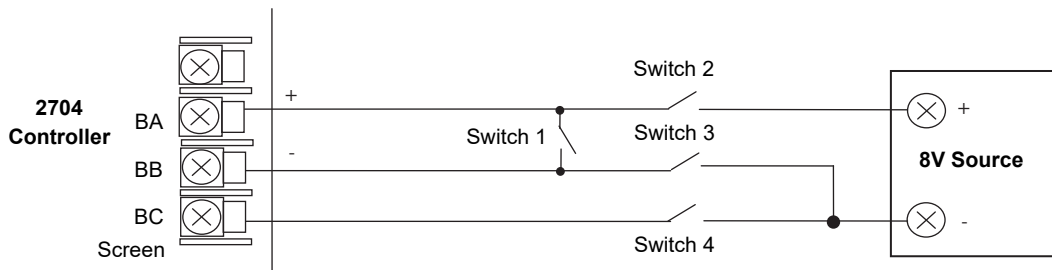

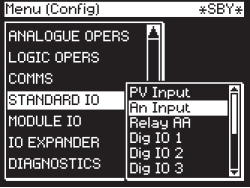

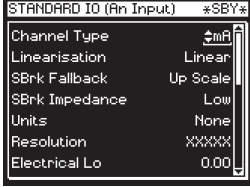







Figure 132 Analogue Input Calibration Connections

Do This	This Is The Display You Should See	Additional Notes
<p>1. From any display press  as many times as necessary until the 'STANDARD IO' page header is displayed.</p> <p>2. Press  to select sub-headers and 'An Input'</p>		
<p>3. Press  to select the parameter list</p> <p>4. Press  again to edit 'Channel Type' if necessary.</p>		<p>The Channel Type may be mA or Volts. The calibration procedure is the same.</p>
<p>5. Press  until the parameter 'Cal State' is displayed</p>		

To calibrate Offset

Connect + and - terminals together by closing switch 1. Open switches 2, 3 and 4 to allow the short circuited inputs to float.

<p>6. Press  or  to choose 'Offset'</p>		<p>The procedure is now the same as paragraphs 9, 10 and 14 for mV calibration.</p>
---	---	---

To calibrate Common Mode Rejection Ratio

Close switches 2 and 4, while switch 1 remains closed and switch 3 remains open, so that 8V is applied to both + and - input terminals with respect to the Screen terminal.

<p>7. Press  or  to choose 'CMRR Enhance'</p>		<p>The procedure is now the same as paragraphs 9, 10 and 14 for mV calibration.</p>
---	---	---

To calibrate Gain

Open switches 1 and 4 and close switches 2 and 3 so that 8V is connected to both + and - input terminals while the screen is floating.

<p>8. Press  or  to choose 'Gain'</p>		<p>The procedure is now the same as paragraphs 9, 10 and 14 for mV calibration.</p>
---	---	---

Module I/O

DC Output Module

The DC output module is calibrated in the factory at 10% and 90% of output level.

This is 1 and 9V for 0 to 10Vdc output; 2mA and 18mA for a 0 to 20mA output; 4mA and 18mA for A dual DC output.

The factory calibration can be modified by the user by adjusting the 'Cal Trim' parameter, i.e. Actual Output = Factory Cal (Low & High) Value + User Cal (Low & High) Trim Value. The user trim value can be accepted and saved as for input calibration data.

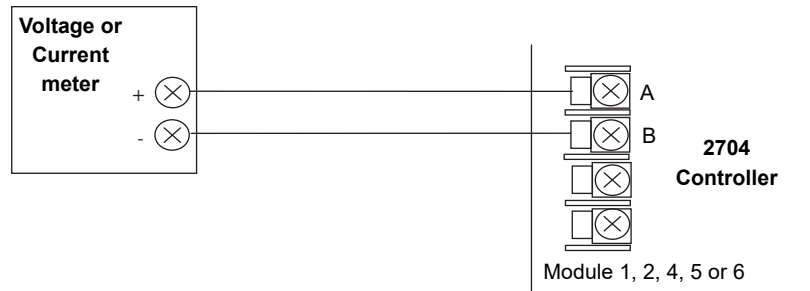







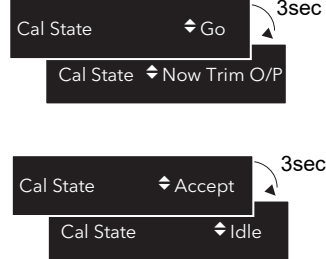









Figure 133 DC Module Connections Volts or Current Output

Do This	This Is The Display You Should See	Additional Notes
1. From any display press as many times as necessary until the MODULE IO page header is displayed		
2. Press to show sub-headers 3. Press or to choose the module in which the DC Output module is fitted		
4. Press until the parameter 'Cal State' is displayed		Other choices are: Cal Low Cal High Restore Factory Save (only appears after cal procedure complete).
5. Press to choose 'Cal Low'		3 seconds after selecting 'Cal Low' the confirm message will appear. The other choice is 'Abort'
6. Press to choose 'Go'		

Do This	This Is The Display You Should See	Additional Notes
7. Press  to scroll to 'Cal Trim' 8. Press  or  to achieve the required output value read by the multimeter - 1.00 Vdc or 2.00mA		The adjustment is between -9999 and +9999. These numbers do not have units and are used for indication only.
9. Press and hold  while pressing  twice to return to 'Cal State' 10. Press  to choose 'Accept'		You can also scroll forward using the  button only. This, however, means that you will need to scroll through all parameters in the list. 3 seconds later the calibration is accepted
11. Press  to choose 'Cal High'	<p style="text-align: center;">Calibrate at 90% Output</p> 	
12. Repeat steps 6 to 10 to calibrate at 90% output. 9.00Vdc or 18mA		
At this point the calibration values are used by the controller. They will, however, be lost when the power to the controller is turned off. From Cal State/Idle :		
13. Press  or  to choose Save		The 10% and 90% calibration values are stored and used by the controller. To return to factory calibration press  to 'Restore Factory'. When 'Idle' appears choose 'Save'

PV Input Module

PV Input modules can be fitted in positions 3 and 6. These modules can provide inputs for thermocouple, 3-wire RTD, mV, Volts or mA. The wiring connections for these inputs are shown below.

The calibration procedure is identical to that described in Section PV Input, but the **Cal State** parameter will be found under the page header **MODULE IO/Module 3 A Page** or **Module 6 A Page**.

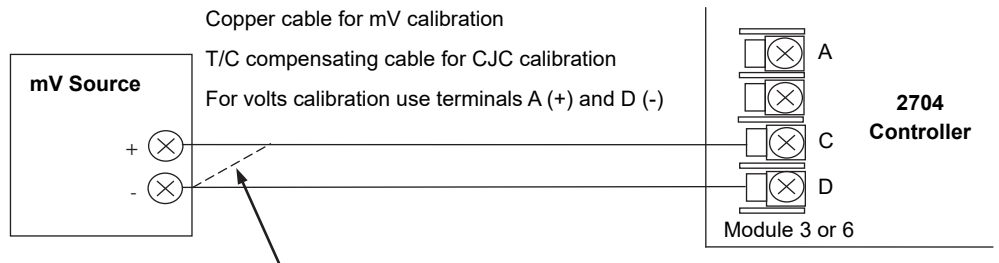

For best results 0mV should be calibrated by disconnecting one of the copper wires from the mV source and short circuiting it to the other wire. This is particularly important to obtain best accuracy for RTD calibration

Figure 134 Volt, mV and Thermocouple Connections to Modules 3 & 6

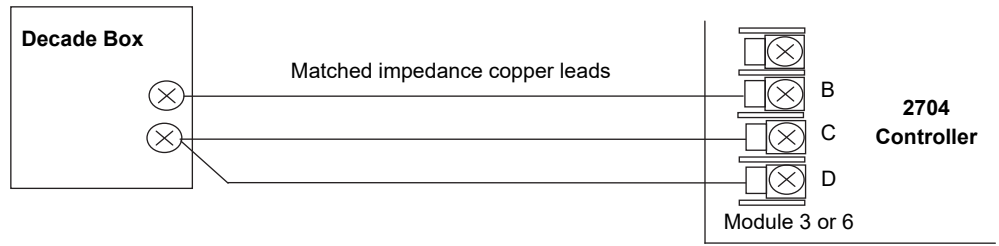

Figure 135 3-Wire RTD Connections to Modules 3 & 6

Dual PV Input Module

The procedure is the same as the PV Input module above, but the parameter ‘**En Dual Mode**’ in the Channel C parameter list must be set to ‘**No**’. ‘**Cal State**’ is accessed from Channel A when enable dual mode is set to ‘**No**’.

DC Input Module

The procedure is the same as the PV Input module above except that only a single mV range is available.

TDS Input Module – Conductance Calibration

Since the module is factory calibrated it is very unlikely that it will be necessary to recalibrate the conductance reading in the field. However, should this become necessary the procedure in this section should be followed.

The TDS module is calibrated at two conductance points:-

- 0mS (i.e. the probe connections open circuit)
- 45.455mS (i.e. at 22Ω resistance)

At the 22Ω calibration point use a resistor that is within ±0.2% of 22Ω to calibrate the module to its specification. Connect the resistor directly to the terminals as shown below or use four short wires less than 1.5m long.

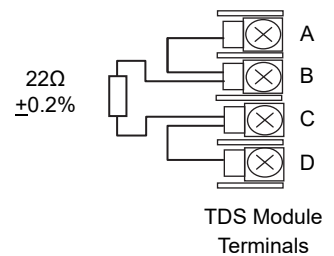

At the open circuit Calibration point take care that outside noise does not contribute to the calibration reading. Keep wires very short or replace them with links connected directly to the controller terminals.

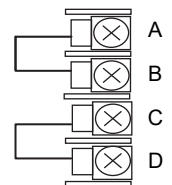

Using the same general procedure as described in the previous sections, proceed as follows:-

- Enter Configuration level and select the particular module slot where the TDS module is fitted. It is a single channel so the slot number will be followed by the letter A.
- Connect 22Ω ($\pm 0.2\%$) resistor as shown above.
- Select the 'Cal State' parameter (initially set to 'Idle')
- Press \blacktriangle or \blacktriangledown button to select 'High – 22ohm'. 'Confirm' this by selecting 'Go'. The controller will automatically calibrate, as described in previous sections
- Assuming the reading falls within the expected range the 'Cal State' parameter will show 'Pass'. Use \blacktriangle or \blacktriangledown button to 'Accept'
- Next open circuit the probe connections and set the 'Cal State' parameter to 'Low – O/C' and repeat the above procedure
- Finally, set the 'Cal State' parameter to 'Save to User' to save the new calibration values

4-Wire RTD Module Calibration

To achieve the specified accuracy 4-Wire RTD Modules must be calibrated using 4-wire resistance reference sources with a recommended 10ppm accuracy. If absolute accuracy is required and the appropriate 4-wire resistance source is not available the user is advised to return the controller to Eurotherm for calibration.

Each module is calibrated at two points, that is, 'Low Calibration' at 0Ω , which effectively is the mV offset calibration for the input, and 'High Calibration' at 200Ω for PT100 Module or 50Ω for PT25 Module.

Low and High calibration should be carried out consecutively using the resistance reference connections shown in the diagrams below.

Main Features

1. Connect a reference source as shown below and allow the instrument to warm up for at least 30 minutes.

Note: This connection retains the test (bulb) current and yet ensures that no voltage is developed across the measured resistance. Do not attempt to calibrate this point by just short circuiting the 4-wire resistance!

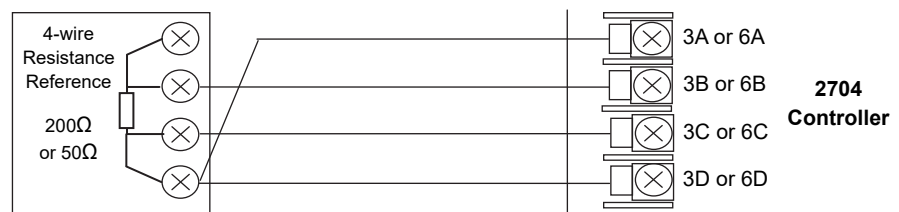



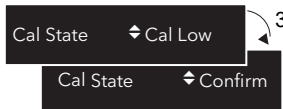

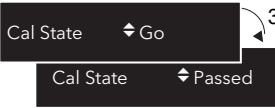



Figure 136 Low Point Calibration Connections

Do This	This Is The Display You Should See	Additional Notes
2. In the relevant MODULE IO page (3 or 6), press  until the parameter 'Cal State' is displayed		
3. Press  or  to select 'Cal Low'		Confirm' will automatically appear
4. Press  or  to select 'Go'		The controller will automatically calibrate and the display will either show 'Passed' or 'Failed'. If 'Failed' check the connections and repeat the procedure
5. Press  to 'Accept'		

6. Re-connect the 'A' terminal wire as shown in Figure 137 and allow at least 4 minutes for the instrument to stabilise. Refer to section Detaching RTD Sensor with Instrument Powered ON.

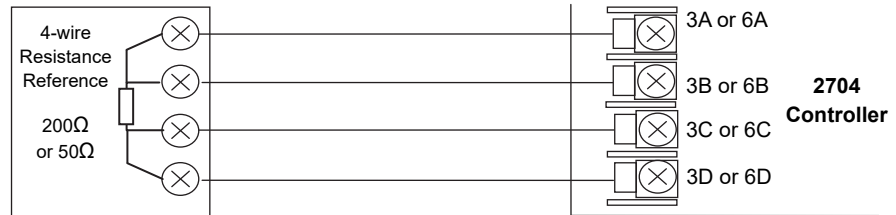



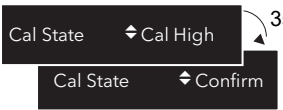



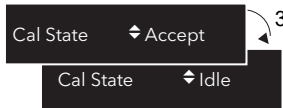





Figure 137 High Point Calibration Connections

Do This	This Is The Display You Should See	Additional Notes
7. Press  until the parameter 'Cal State' is displayed		
8. Press  or  to select 'Cal High'		Confirm' will automatically appear
9. Press  or  to select 'Go'		The controller will automatically calibrate and the display will either show 'Passed' or 'Failed'. If 'Failed' check the connections and repeat the procedure
10. Press  to 'Accept'		It may also fail if the reference resistance is more than $\pm 3\%$ out of that specified. Values must be saved otherwise they will be lost when the controller is powered down.
11. Press  or  to select Save		

Cable Connection Errors

Thermally induced e.m.f. along any non copper connection may contribute to reading errors. It is worth remembering, however, that a significant error can only be induced by the net e.m.f. on inner (B & C) cable connections – see Figure 138 below.

The 2704 rear terminal connector is made of beryllium-copper alloy which minimizes thermally induced e.m.f. at the instrument end. The user must ensure that any non-copper connections between the RTD and the instrument are either eliminated or the temperature gradients along both the inner connections are identical. Nevertheless, at thermal equilibrium, any net e.m.f. can be calibrated out by doing 'Low Point Calibration' (see Figure 136).

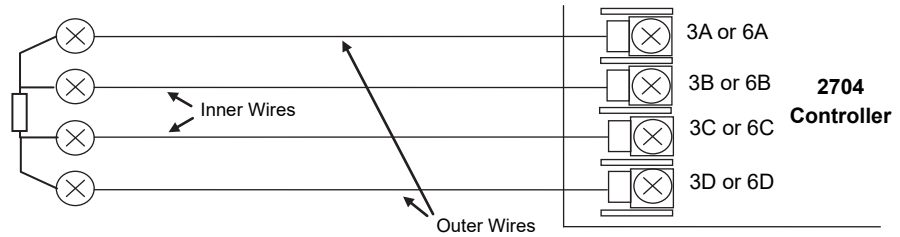

Figure 138 Thermally Induced E.M.F's in RTD Connections

Maximum Resistance of Outer Wires

The maximum resistance of outer wires is the difference between the total maximum resistance connected between A and D terminals and the expected maximum resistance of the RTD. Therefore, the maximum resistance of each outer wire for guaranteed operation up to the maximum of PV resistance reading is 30Ω for Pt100 module and 5.5Ω for Pt25 module. However, using the appropriate RTD for the appropriate module up to a typical measuring temperature of 800°C will permit the cable resistance limit to increase to 60Ω and 18Ω per cable respectively. Resistance of any connecting wire, within specified limit, does not contribute to reading errors.

Detaching RTD Sensor with Instrument Powered ON

All inputs available in the instrument are primarily designed to remain wired to their appropriate input sensors while the instrument is powered on. However, disconnecting and re-connecting any input with the instrument on is possible but a temporary reduction in reading accuracy should be expected. The error magnitude and its recovery time to within specified limits are input type specific, and depend on the length of time the input was disconnected as well as the way in which it was disconnected or re-connected.

The 4-wire RTD input will stabilise/recover to the specified limits within 5 minutes of re-connecting the input, provided that:

- The terminal A, which sources the sense current is disconnected first and re-connected last (i.e. B, C and D are connected to the RTD sensor before connecting A terminal).
- The B, C and D inputs are not disconnected for more than two hours
- No static discharge between B, C and D terminals has just occurred (i.e. static precautions should be observed)
- No external source of more than 200mV was applied between the above three terminals

Otherwise recovery may take up to a few hours.

To Restore Factory Calibration Values

Do This	This Is The Display You Should See	Additional Notes
1. Press  until the parameter 'Cal State' is displayed		
2. Press  or  to choose ' Restore Factory '		The factory calibration values are restored for the input selected, i.e. if the Analogue Input is selected the PV Input and Module input values are not affected.

Boiler Control

The 2704 contains function blocks and hardware that are primarily designed for use in controlling water impurities in shell type industrial Boilers. Other aspects of Boiler Control such as level and pressure control can be set up using standard PID blocks and this is covered in other chapters.

Introduction

Water admitted in a boiler system is heated and taken out as steam. Dissolved solids are in the water that are added to the system and these solids are left behind when the water is converted to steam. At high parts per million (PPM) levels 'foaming' on the surface of the water occurs which may then cause loss of efficiency of the boiler or blockage in the outlet pipes. It is therefore essential, although costly in terms of energy and money, to drain away some of the boiler water and top it up with less contaminated fresh water. This draining process is known as "Continuous Blowdown" or as "Continuous TDS Control". TDS (Total Dissolved Solids) is normally controlled at a value of about 2500PPM. When the TDS is high the controller opens a valve to bleed water from the boiler with the effect of reducing the water level. The level controller compensates for this by introducing water with a low TDS value thus reducing the overall TDS. Water treatment and high temperatures cause some of the contaminants to precipitate. To remove sludge and precipitated solids that accumulate at the bottom of a boiler an intermittent blowdown method called "Bottom Blowdown" is used. This is performed periodically by opening a large valve at the bottom of the boiler for a short period of time.

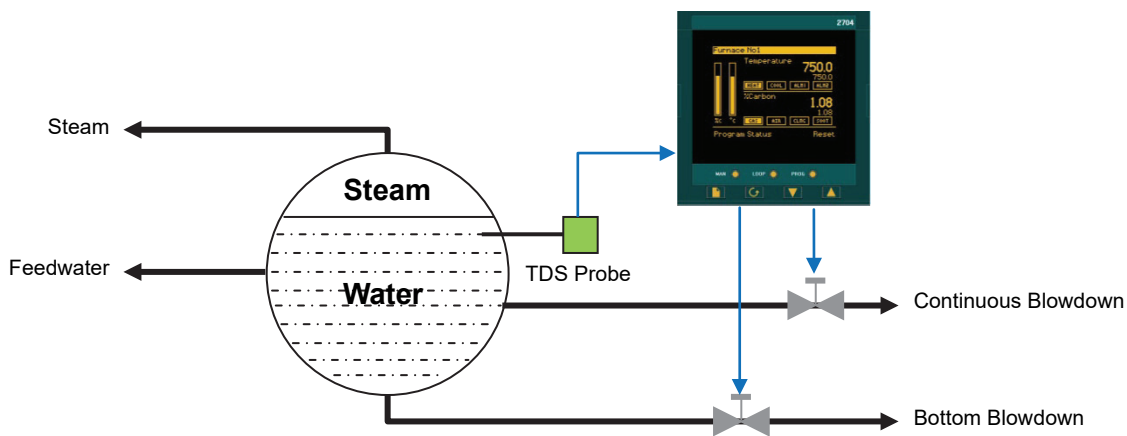

Figure 139 2704 Control of TDS and Precipitated Solids in a Boiler

What is TDS?

TDS (Total Dissolved Solids) is the measurement of the amount of solids dissolved in water.

The measurement is often expressed in **PPM** (parts per million). This PPM value directly indicates the mass of dissolved solid molecules in the fluid as a proportion of the total mass of the solution i.e. 200PPM indicates that for every million grams of the solution there are 200g that are not water. The most reliable way of measuring TDS is to evaporate water from a unit volume of a solution and to weigh the solid residue (commonly referred as **TDR** - total dry residue). Fortunately, the solids dissolved in naturally occurring water are of the type which cause water ionisation, and hence, have a direct influence on its electrical conductivity. By measuring conductive properties of such solution a relatively accurate estimate can be made of its TDS.

How is TDS Measured?

There are several factors to take into account when measuring TDS electronically. The following sections describe these factors.

‘Specific Conductance’

Specific conductance is a measure of the ability of a fluid to conduct an electrical current as measured using a 1-cm cell and is expressed in units of electrical conductance, i.e., micro-Siemens per centimetre. Specific conductance is related to the type and concentration of ions in a solution and can be used for calculating the dissolved-solids content of the water. Commonly, the concentration of dissolved solids in PPM is from 55 to 75 percent of the specific conductance in micro-Siemens/cm at 25°C. This relationship is not constant and it may vary with changes in the composition of the water, in particular its pH level. We refer to this relationship as **PPM conversion factor** with a default value of 0.7 (i.e. 70%) for a typical water solution with neutral pH.

Increasingly often **µS /cm@25°C** (micro-Siemens/cm at 25°C) are used as alternative units for TSD indication as they are independent of the chemical constituents of the fluid and can be directly compared with readings of a calibrated conductance meter.

As the fluid under test may not be at 25°C, particularly boiler fluid, the conductance reading will have to be temperature compensated to hold relationship to TDS.

In the 2704 controller this is usually automatically done by sensing liquid temperature and applying an appropriate correction factor to each reading of conductance. In cases where the temperature sensing is not available the user must estimate this temperature (derived from boiler pressure – for example) and enter it manually.

Temperature Correction Factor – $TCF_{25}(T_{Liquid})$

If the actual temperature of the fluid under examination is different to that of the reference temperature of 25°C the readings need to be temperature compensated to derive a valid TDS estimate. Almost always, hotter fluid will conduct better than the same fluid at a cooler temperature. Therefore, it is usual to measure the temperature of the fluid and divide the conductance reading by a number that represents the fractional change of the conductance. This number is called “Temperature Correction Factor” and conveniently noted as $TCF_{25}(T_{Liquid})$ - where T_{Liquid} is the temperature of the liquid and the subscript 25 signifies the reference temperature for which the reading is to be adjusted.

- **Linear Temperature Compensation – ‘Temp Coef’**

Most common way of deriving TCF is by applying linear temperature compensation which is determined by a single parameter, called Temperature Coefficient – ‘Temp Coef’ (typically 2% /°C) and calculated according to:

$$TCF_{25}(T_{Liquid}) = 1 + \frac{2\% / C}{100\%} * (T_{Liquid} - 25)$$

Diagrammatically this is represented as:

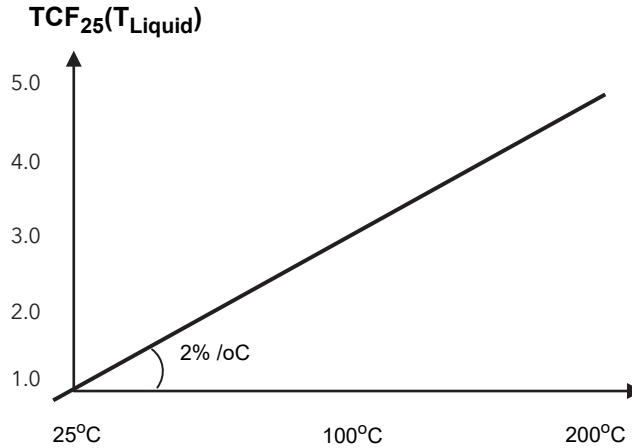

- **TCF Calibration**

As the temperature coefficient may vary according to chemical constituent of the fluid and the temperature itself the most reliable way of determining TCF is by calibrating TCF at a range of temperatures, tabulating it and deriving the actual $TCF_{25}(T_{Liquid})$ by interpolating the tabulated values. The 2704 controller can perform this calibration automatically.

Probe Factor (K)

The ‘Probe Factor’, or ‘K’, indicates a relationship between the conductance measured with the probe and the specific conductance of the fluid.

Fluid conductance probes are based on a ‘model probe’ that has two electrodes exactly 1cm² in area and spaced exactly 1cm apart. In practice these dimensions vary from probe to probe so the probe factor converts the conductance read by the probe to the value that would be read if the model probe were used. The K factor is measured in units of 1/cm – therefore:

$$\text{‘Specific Conductance’ (in } \mu\text{S/cm)} = \mathbf{K (in 1/cm)} * \text{‘Measured Conductance’ (in } \mu\text{S)}$$

For most boiler probes K is in range 0.1 to 1 and the value is affected by installation.

Probe Design and TDS Module Operation

TDS probes are usually characterised according to the number of electrodes that are present. A 2-electrode design is the most commonly used in boiler installations although both 3 and 4-electrodes are also found. The basic construction of the 2-electrode is shown below where the boiler metal work is used as one of the electrodes. The conductance is, therefore, measured between the centre electrode and the probe casing or the boiler’s body shell.

The 2704 TDS Module delivers a 1Khz alternating signal of ~0.4Vpp (peak to peak amplitude) from the driver terminal A. The driver sense terminal B and ground sense terminal C measures the return voltage and automatically compensates for cable resistance by adjusting the driver voltage to obtain 0.4Vpp at the probe. The PV is a conductance (a reciprocal of resistance in units of Siemens [S] = [1/Ω]) measured between terminals A/B & C/D from which the water specific conductivity and hence TDS is derived.

Normally a temperature sensor, usually Pt100, is included within the probe construction and connected to another 2704 module. This allows the conductance to be compensated for temperature fluctuations.

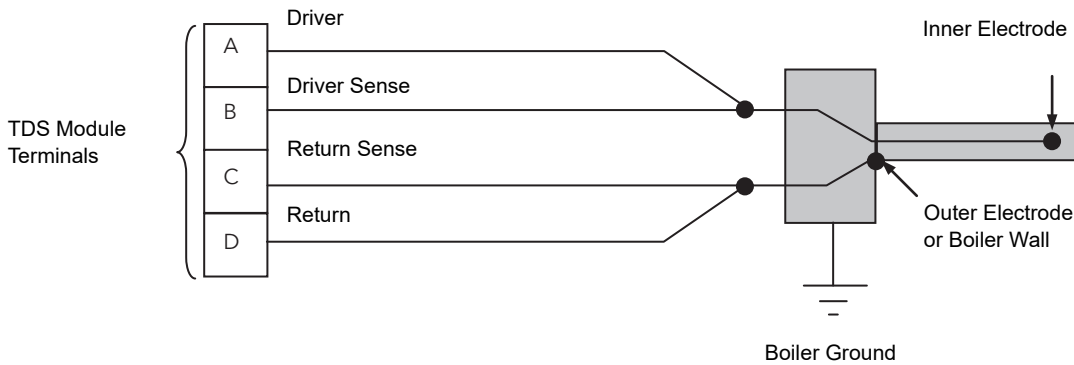

Figure 140 Two Electrode TDS Probe

Probe Deterioration

When a probe is immersed in a fluid a certain amount of solids will bind to the probe. This can be seen as 'scaling' on the probe itself.

In case of only two electrode probes any scaling or deterioration of these electrodes will affect the conductance reading. For example, with the probe immersed in water, lime-scale will collect on the measuring electrodes. That lime-scale has a high resistance and will inhibit the probe from making an accurate reading. This problem, however, is largely overcome by making a regular calibration of the system against a reading from the water sample - i.e. titration.

The calibration directly affects K factor which tend to be larger for the scaled probes than the initial (clean) probe factor established during the system installation. The 2704 makes a distinction between the initial probe factor calibration – called 'TDS Cal' and the subsequent probe factor calibrations called – 'Probe Cal'. The difference between the latter and the former K factor values is a measure of the probe deterioration that is monitored by the instrument, alerting user of the potential problems.

In case of 3 or 4 electrode probes the effect of scaling is largely compensated by the hardware of the instrument producing consistently accurate reading despite the scale and so the subsequent 'Probe Cal' and the initial 'TDS Cal' should produce very similar K value. There is a limit to that compensation, however, and so the instrument monitors the extent of scaling by measuring the signal strength required to drive the probe, - called 'Driver O/P'. Monitoring of scaling has also a benefit of providing a diagnostic about the internal state of the boiler and an effectiveness of the feedwater treatment.

Driver O/P

The level of the driver signal (i.e. the ac voltage between terminals A and D) is monitored by the controller and displayed as a % of the maximum possible signal, ~ 5Vpp.

In order to retain 0.4Vpp at the probe, the driver signal will always be sufficiently greater than this to compensate for the voltage drop along the wires and the losses in the probe itself. The compensation for probe losses applies only when 3 or 4 electrodes are employed and monitoring of Driver O/P can be used to indicate the extent of probe scaling. With 2 electrode probes, provided the wire losses are relatively small, the Driver O/P will remain at less than 10%, whereas with clean 2 or 3 electrode probes it will be somewhere between 10% and 20% depending on probe geometry. The latter may easily exceed 100% for heavily soiled electrodes. A value > 110% causes Sensor Break.

Bubbles

When measuring TDS in an environment where the liquid is hot (for example a boiler system) there is always the chance that bubble's are going to be generated and will interfere with the signal. This is because the conductance of steam, for example, is less than that of water. Therefore, when bubbles come in contact with the electrodes of the TDS probe the effective conductance will drop. If this were viewed on a graph the bubbles would appear as negative going spikes on an otherwise smooth graph.

TDS Function Block

All the factors influencing derivation of the TDS PV described in section How is TDS Measured? are taken into account and incorporated into TDS Function Block. The TDS Function Block takes the 'Conductance' reading from TDS Input Module as well as a temperature from another input and performs certain calculations to derive a TDS value. The calculations are based on number of set parameters and various calibration procedures performed through this Block.

The TDS Function Block is enabled using the 'Boiler' feature code. The 'Boiler' feature code also enables the Bottom Blowdown Function Block.

Installation versus Operation Modes

The Function Block has two distinct modes of operation. The first mode is the Installation Mode that deals with setting up all the necessary parameters of the system to provide TDS readings. This includes those determined by the calibration procedures that can only take part with the system running and hence they could not be obtained at configuration level. The second mode is the system Operation Mode which permits for regular re-calibration of TDS readings against titration readings. Disabling the possibility of easily modifying the installation mode parameters is important because they form a reference against which the system deterioration is measured at subsequent system calibrations. For this reason 'set-up' parameter was introduced – see section 'Set-up' Parameter.

Probe Deterioration / Scaling

The performance of TDS probes (particularly the 2 electrode) may deteriorate during use due, for example, to scaling.

Probe deterioration (scaling) is determined and compensated for by performing a periodic live calibration specifically designed for this task, called - 'Probe Cal'. This calibration mechanism, together with the current readings generates an 'Apparent K' or 'Current probe factor' that includes any deterioration of the probe. This value can then be compared to the initial probe factor to determine the amount of deterioration that has taken place. Limits can be set on Apparent K using 'Max Apparent K' parameter and warnings given when exceeded indicating that the probe may require a service. The warning is given by the flag called 'Clean Probe Rq'. This means of detecting probe scaling is only useful for 2 electrode type probes.

TDS Function Block Parameters

The TDS Function block has input and output parameters as well as key internal variables as shown in the table shown below.

Table 112: This list allows you to set up the parameters for boiler control		BOILER (TDS)		
Parameter Name	Parameter Description	Value	Default	Access Level
TDS Status	Indicates the overall status of the TDS function block. See section TDS Function Block Parameters for more information.	OK No Temp Calibrating Confirm Change FAIL		L3
Units	Function block output units (i.e. TDS PV units)	µS/cm@25°C PPM	µS/cm@25°C	L3
PPM Conversion	Conversion factor for calculating PPM from µS/cm @25°C. Shown when 'Units' = 'PPM'	0.000 to 1.000	0.7	L3
Resolution	This defines the resolution of 'specific conductance' output. For a 'units' setting of PPM, the resolution should be set to xxxxx.	xxxxx xxxx.x xxx.xx xx.xxx x.xxxx		L3
FallBack	Fallback setting which the controller will take if the calculation is invalid. ie 'Invalid PV' = 'True'	Off Low = OP set to 0 High = OP set to 500.000		L3
Bubble Filter t	Bubble Filter time constant limiting the rate at which the signal is allowed to fall while not limiting the rate at which it is allowed to rise	HH:MM:SS.s	0.4sec	L3
TDS PV	TDS output either in terms of temperature compensated specific conductance or PPM	µS/cm@25°C PPM		L3
Invalid PV	Flag indicating the validity of the function block output	True = Invalid output False = Valid output		L3
mS Src	Source address of TDS input, typically wired from TDS Module Eng Val (i.e. Conductance)	Modbus address		Conf
Temp Src	Source address of temperature PV input. Should be wired to a valid temperature input or alternatively wired to a user value	Modbus address		Conf
Setup Params	When enabled allows parameters to be available in level 3 (including this parameter). It also changes the options available in the calibration state. This is to allow for the installation set-up to be completed while the system is active without always giving access from level 3. See section 'Set-up' Parameter	Disabled Enabled		Conf and L3 if set to enable
K-Factor ***	Probe constant, entered by the user Units are 1/cm	Auto = 0.3 or 0.001 to 99.999	Auto	L3
K-Factor val ***	The actual value for K_Factor being used by the system.			L3
Temp Coef ***	Temperature coefficient for deriving linear temperature compensation	Auto = 2.0 or 0.1 to 100.0	2.0%/°C	L3
Temp Coef val ***	The actual value being used by the controller.			L3
Use Table	Select to use the TCF table for deriving temperature compensation. The table will only be available if a TCF calibration has been done, otherwise this parameter is NOT shown.	Yes No		
Confirm Change	This parameter is used when the settings of 'K-Factor' and 'Temp Coef' are changed and conflict with the TDScal. It is only available if there is a need to confirm a change, is used to indicate the problem and guide the user through the possible options (Override TDScal, cancel change etc). See section 'Temp Coef', 'K-Factor' and 'Use Table' Parameters			

Table 112: This list allows you to set up the parameters for boiler control		BOILER (TDS)		
Parameter Name	Parameter Description	Value	Default	Access Level
TDScaI Status	Status of TDS calibration. 'Overridden' is used to override previous calibration due to manual settings. See section 'Temp Coef', 'K-Factor' and 'Use Table' Parameters	Default Valid Overridden		L3
Calibration	Calibration state machine controls. See section TDS Calibration for more details and to enable probe calibration.			L3
Probe Cal	Periodic calibration following titration. See section TDS Calibration for further information and how to enable this parameter.	Off On	Off	L3 if Setup Params=Disabled
TCF Cal	Establishing a set of Temperature Correction Factors (every 10 °C) for a particular water type. See section TDS Calibration for further information			
Cal State	Indicates whether calibration is active and the type of calibration being carried out	Calibration Inactive Probe Cal TDScaI TCFcal		Conf
Cal Data Entry	Titration result entry point under calibration conditions. The data is assumed to be in the same units as the function block 'Units' setting. Only available when the 'Calibration' parameter is in one of the 'Enter Data' states.			L3
Apparent K	Current probe factor derived from the 'Probe Cal', 'TDS Cal' and current readings. This is used internally within the function block as a substitute for 'K-Factor' and is outputted for diagnostic purposes.			L3
Max Apparent K	Maximum limit for apparent probe factor. If this is breached then the function block will set 'Clean Probe Rq' to 'Yes'.			Conf
Probe Clean Rq	Flag indicating that Apparent K has exceeded the 'Max Apparent K' parameter.	Yes = 'Apparent K' > 'Max Apparent K' No' if not.		L3
RPercent	Parameter that models non-linear behaviour of probes and requiring two different titration values to determine it. It represents the anticipated percentage contribution split between probe surface contamination errors and probe scaling errors at Probe Cal.	0.0 to 100.0 %/cm		Conf

*** Note that 'Temp Coef' and 'K-Factor' may be dependent on each other. See section 'Temp Coef', 'K-Factor' and 'Use Table' Parameters.

Further Parameter Descriptions

TDS Status Values

Enumeration	Display	Description
0	No temp	This status indicates that the temperature input is required but is not valid, therefore the temperature compensated outputs are invalid.
1	Confirm Change	This status indicates that there has been a manual change to either 'K' or 'TCOE' that requires the user to confirm the change and make a decision about what action to take from the options given.
2	Calibrating	This status indicates that the function block is performing one of its calibration cycles. The TDS Output parameters continue to be valid during any of the calibration cycles. The values used within the system will not be updated until the calibration has passed and been accepted.
3	Fail	This status indicates that there is not a valid TDS input wired to the function block and therefore the TDS output is invalid.
4	OK	All output parameters valid.

'Temp Coef', 'K-Factor' and 'Use Table' Parameters

To aid the initial set-up of TDS parameters in any situation, the TDS Function Block allows the user to set the known parameters while attempting to calculate the parameters which have been set to AUTO utilising the last TDS calibration. If however, the setting of one parameter causes the other parameter to go beyond its limit threshold then the user is prompted with a message to check the 'Confirm Change' parameter. Under these circumstances the 'Confirm Change' parameter will indicate the 'out of range' condition and only give an option to cancel the last change. The calculated parameters 'K-Factor val' and/or 'Temp Coef val' are displayed only if 'K-Factor' and/or 'Temp Coef' are set to AUTO respectively. They are displayed for the user to verify that the values are within expected limits.

The table below shows all the possible combinations of these parameter settings together with the option of using the TCF Table. In boiler control applications the second option - AUTO/SET is the most commonly used as typical boiler probes have a poorly defined probe factor and, in addition, this could change during installation – refer to the table.

If, however, the user chooses to set both parameters manually (SET/SET option) then he will again be prompted to check the 'Confirm Change' parameter. This time the 'Confirm Change' parameter will indicate that the current action will invalidate the last TDS calibration. The user will be supplied with options to cancel the last change or 'Override Cal'.

User settable parameters			The actual parameter values used by instrument to calculate TDS		
K-Factor	Temp Coef.	Use Table	K-Factor val	Temp Coef. val	TDS Cal is valid
SET	SET	NO	As set by user	As set by user	NO
		YES	As set by user	As set by user, however, it applies only to temperatures outside the Table.	NO
AUTO	SET	NO	Determined by the last TDS calibration	As set by user	YES
		YES	Determined by the last TDS calibration	As set by user, however, it applies only to temperatures outside the Table	YES
AUTO	AUTO	NO	Determined by the last TDS calibration	Default value = 2% /°C or the last value (user set or auto calculated) before setting Temp Coef to AUTO	YES
		YES	Determined by the last TDS calibration	Extrapolated average value from the start and end points of the Table	YES
SET	AUTO	NO	As set by user	Determined by the last TDS calibration, however, it applies only to temperatures outside the Table.	YES
		YES	As set by user	Determined by the last TDS calibration	YES

'Set-up' Parameter

The TDS Function block is required to complete its installation set-up and calibration while the system is running (not in Conf. access level). It is therefore necessary to make certain parameters available at access level 3 while the installation and calibration are being completed.

This is accomplished by the 'Setup' parameter. If set to 'Enabled' the parameters available in Level 3 are:

Setup (itself), K-Factor, Temp Coef, Use Table, PPM Conversion setting.

The 'ProbeCal' becomes unavailable within the calibration state machine and 'TDScaI' & 'TCFcaI' become available. For more information please see the following calibration section.

Once the installation set-up and calibration have been completed then the 'Setup' parameter may be set back to 'Disabled' while still in Level 3. This will make the 'Setup' parameter and the additional parameters that were made available to disappear from the level 3 parameter list – including 'set-up' parameter. To restore access to the set-up parameters and initial system calibration the unit will have to be placed into Conf. level access and the 'Setup' parameter set back to 'Enabled'.

TDS Calibration

The calibration system within the TDS Function block consists of three calibration mechanisms. One calibration mechanism is for regular calibration to adjust for probe scaling etc. The other two are used only during system commissioning (installation) or annual maintenance service.

The three calibration systems are outlined below:

Name	Description	Section
Probe cal	Performed occasionally (every month or so) to compensate for probe scaling, deterioration etc.	Used during normal operation. Only available when NOT in config mode AND 'Setup' = 'Disabled'.
TDScaI	Probe calibration used to determine and set up initial probe factor performed just after system installation or the annual maintenance service.	Installation Calibration. Available in all access levels when 'Setup' = 'Enabled' or only in CFG level access when 'Setup' = 'Disabled'.
TCFcaI	Used at installation to determine and store the temperature correction factors for the particular type of boiler fluid.	Installation Calibration. Available in all access levels when 'Setup' = 'Enabled' or only in CFG level access when 'Setup' = 'Disabled'.

The function block status will show 'Calibrating' while in any of the calibration modes. Although the status will show 'Calibrating' the 'Invalid O/P' parameter will not be set as the calibration routines do not affect the output validity.

If there is a power failure/cycle during any of the calibration cycles then the calibration cycle will be aborted.

The internal parameter 'Cal State' indicates to the function block status the actions of the calibration system. The 'Calibration' parameter will only be alterable when the function block status is 'OK' (or calibrating). The 'Cal Data Entry' parameter will only be available/alterable when the Cal mode is in one of the 'Enter Data' states (described in more detail later).

The following table shows 'Cal State' enumerations Vs calibration mode:-

Cal State	Name	Status Setting
0	Calibration Inactive	No effect
1	ProbeCal	Calibrating
2	TDScal	Calibrating
3	TCFcal	Calibrating

The actual values the TDS function block uses during the calibration are unchanged (stored internally) and only updated once the calibration (or manual adjustment) is completed and accepted. Only then are the internally used values updated. If the calibration (or manual adjustment) are cancelled at any time then the original values from before the calibration (or manual adjustment) were made are restored.

Each of these calibration mechanisms are detailed below:

ProbeCal

The 'ProbeCal' is periodic calibration that will involve the user directly measuring the conductance of the boiler water through titration. This value (usually measured using calibrated reference conductance meter) is then entered into the instrument. The value must be entered in the same units as the units set for the TDS PV (PPM or $\mu\text{S}/\text{cm}@25^{\circ}\text{C}$). The value entered and initial 'K-Factor' value are used to calculate 'Apparent K'. This 'Apparent K' will then be substituted as the current probe constant throughout the TDS Function block.

The user may wish to indicate to the instrument the instant the titration sample was taken. This is done by starting the calibration. The instrument will then immediately acquire and store the read value. The calibration, however, will become valid once the user enters the cal value. This is because it may take some time to acquire a titration value, by which time the instrument could have a different reading.

ProbeCal is not available when 'Setup' is set to 'Enabled' or when in CONFIG access level.

TDScal

The 'TDScal' is one of the installation calibration mechanisms. It is done in the same way as the above calibration but by the system installer or the annual maintenance servicemen. TDScal is used primarily to determine the initial probe factor, although, if the initial probe factor is known and entered into the instrument then this mechanism will try to modify the temperature coefficient. Essentially, if the probe factor is fixed then the temperature coefficient is adjusted to make the calibration valid.

TDScal is not available outside Conf. access level when 'Setup' is set to 'Disable'.

This calibration mechanism is available in all access levels when the 'Setup' parameter is set to 'Enabled'. Otherwise it's only available in Conf. Access level.

For more details regarding the mechanisms involved with this calibration system, see section TDS Calibration Using Cal State Parameter (Cal State Parameter).

TCF Cal

The 'TFC Cal' calibration is also part of the installation set up. This is not available outside Conf. Level if 'Setup' parameter is set to 'Disable'.

To calibrate TCF the boiler must be filled with water and fired. At some water temperature (preferably well below 100°C) all the outlets should be shut off and the temperature of the boiler should be slowly raised to its maximum operating temperature. Just as the outlets are shut the user should start TCF Cal. The instrument will then take readings every time a decimal temperature point is reached. For example, if TCF Cal was started when boiler water was at 53°C then the first calibration reading will take place at 60°C and the next one at 70°C and so on. The instrument will continue taking readings until the user select 'stop' parameter of the TCF Cal. This should be done after the boiler water has reached the maximum operating temperature.

Providing that the TCF Cal is then accepted the TCF Table is created. This table could be used for deriving temperature compensation if 'Use Table' parameter is set to Yes.

Note: At least two cal points must be acquired for the calibration mechanism to complete successfully.

TDS Calibration Using Cal State Parameter

The Cal state parameter is used to control a calibration state machine that deals with all three calibration mechanisms.

The options that are available to the user in any access level other than Conf. are dependent on the setting of the 'Setup' parameter.

The sequence of options available are shown in the diagram below:

Setup = Disabled

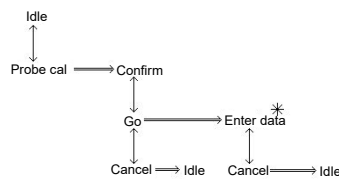

Setup = Enabled

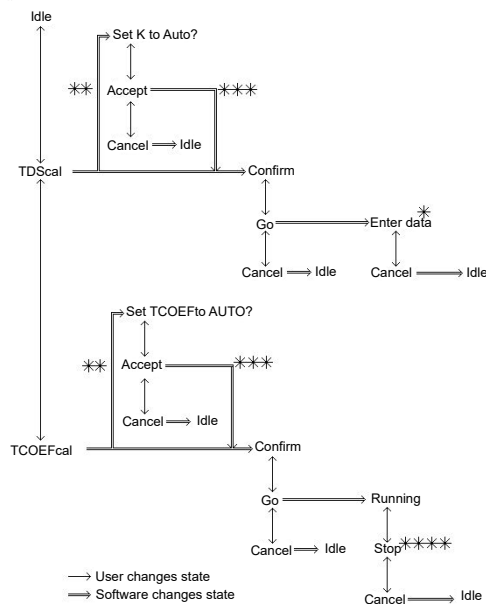

NOTES:

* = State will change to 'Confirm' once the user has entered the data representing the manually acquired TDS Value (in the correct units) with options for 'Accept' and 'Reject' as long as the calibration was successful. If the calibration was unsuccessful then the state will change to 'Failed' with an option to 'reject'. The data entry parameter will only be available while the state machine is in these states.

** = This path is only taken if neither 'K-Factor' or 'Temp Coef' are set to AUTO – at least one of them needs to be set to AUTO to allow the calibration to function.

*** = Once 'accept' has been selected then the relevant parameter is set to AUTO by the software.

**** = Once stop is selected the calibration state machine will change to 'Passed' with options to 'accept' or 'cancel as long as all is well. If the TCF Cal has failed then it will change to a state indicating the error and giving an option only to 'Cancel'.

If any of the 'Cancel' selections are made then the calibration sequence is aborted and the status returned to 'Idle'. For these reasons, the 'Calibration' parameter is bi-directional (can be set by the user or by the software).

Function Block Status Enumerations

The following table describes each of the status enumerations...

Enumeration	Display	Description
0	OK	All is well – Not calibrating, no errors. Invalid O/P = FALSE
1	NO TEMP	The temperature input required but is invalid. Invalid O/P = TRUE
2	Confirm Change	The user is required to check the 'Confirm Change' parameter and make a decision about what action to take from the options given.
3	Calibrating	The calibrations state machine is not idle.
4	FAIL	The TDS Conductance input is invalid. Invalid O/P = TRUE

For a full description of these states and their priorities, please see section TDS Calibration.

Bottom Blowdown Function Block

Traditionally to lower the TDS a boilerman would open a valve in the bottom of the boiler to let water out and lower the TDS. Installing a TDS controller removes the need to do this to lower the TDS value but there is still a need to blowdown the sediment that forms at the bottom of the boiler. To minimise the energy loss, blowdown is restricted to between 3 and 30 second burst probably twice a day at a time selected by the boilerman. The blowdown (water) normally passes to a blowdown vessel, usually sized to cope with dissipating the energy from a single boiler. Because of this a Health and Safety Guideline (PM60 in the UK) dictates that adjacent boilers should be inhibited from blowing down at the same time.

Bottom Blowdown of Multiple Boilers

When the blowdown time is reached a sequence of network integrity checking and pre-wait will take place before the bottom blowdown valve is opened. While a boiler is in the pre-wait blowdown or cool down states all other boilers connected to the network will be inhibited from performing blowdown. This is necessary as the blowdown pipe or vessel is only capable of dealing with one blowdown at a time. If a blowdown is inhibited by another blowdown in progress the system will wait until the cool down period has expired before blowdown continues. Figure 141 shows an overview of the high integrity bottom blowdown system connected to three boilers.

D* = Any digital I/O terminal

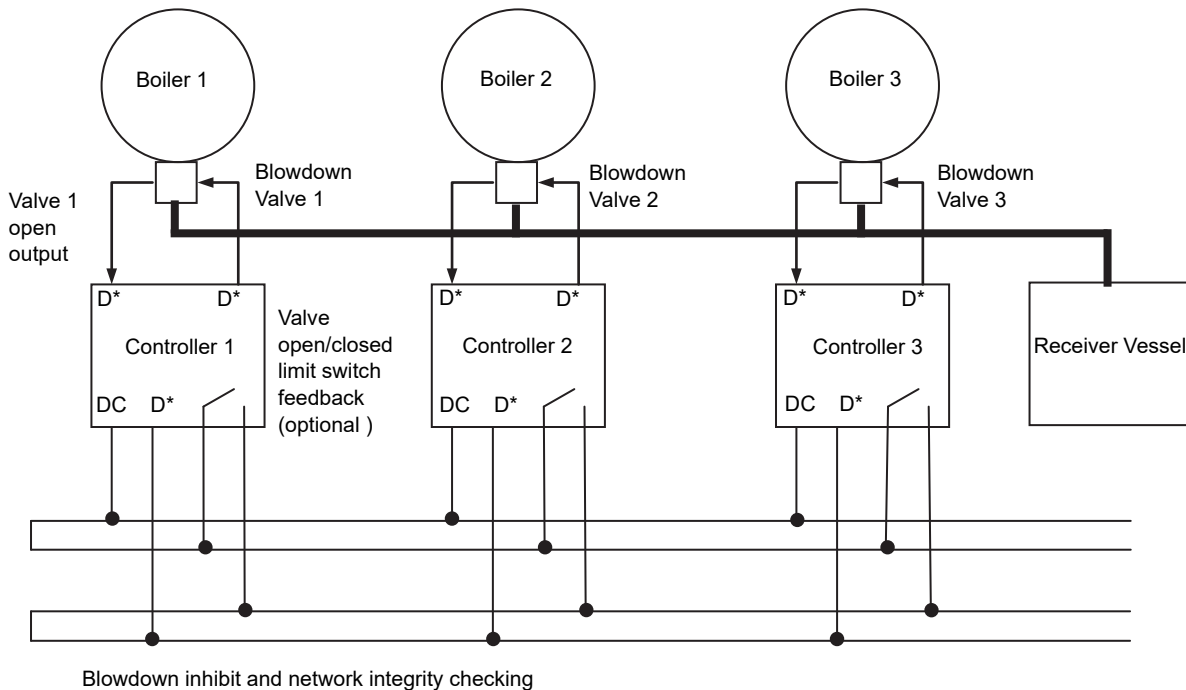

Figure 141 Blowdown Network Integrity Checking

Operating Principles of High Integrity Interlock Bus

Interlocking of instruments is shown in Figure 142.

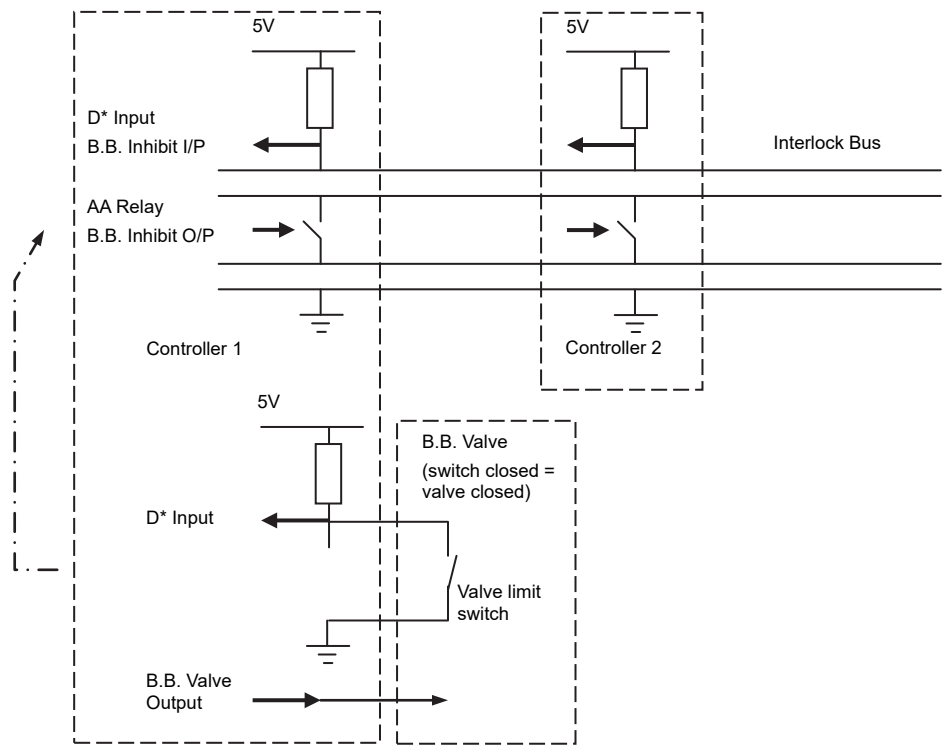

Figure 142 Interlock Bus

Each controller contains a floating switch output and a digital input with a pull-up. The switches are normally open so that the potential on the top two lines is +5V 'high' with respect to the bottom two lines. This high signal is seen by all inputs connected to the network and is interpreted as Bottom Blowdown enable. Closing any switch causes the top two lines to be shorted to the bottom two lines resulting in a 'low' signal interpreted as Busy/Bottom Blowdown disable. This is only the case if three conditions are met:-

1. The wires form an unbroken link chain
2. The controller signaling 'Busy' is fully connected to the network
3. The controllers receiving 'Busy' are also connected to the network

Providing that the network is complete, any controller can short the network and verify that it has done so via its own input. Network checking is carried out at the start of each blowdown sequence in this way to ensure that the controller is correctly connected to the network. If the controller detects an error with the network an alarm will be activated and the network state shown.

Blowdown Sequence

When the blowdown time is reached the following sequence takes place:-

'Blowdown State' will change from 'BB Wait' to 'Check Network' for only a few seconds. At this point the controller switches the network between high and low states. This is to determine if any other controller is blowing down at the same time

- a. Assuming no other controller is blowing down, the network is pulled to a low condition to lock out any other controller at this time. 'Pre BB Wait' is shown for a settable period, such as 15 minutes (half of 'Cool Duration').
- b. After 'Pre BB Wait' the blowdown output will come on for a few seconds (set by the 'BB Duration' parameter) and the 'Blowdown State' will show 'Blowing Down'.
- c. The 'Blowdown State' will then show 'Cooling Down' for a settable period, such as 15 minutes (the other half of cool time)
- d. After 'Cooling Down' the blowdown sequence is complete and the network will go high allowing other controllers to blowdown if they want

The sequence is shown graphically below:

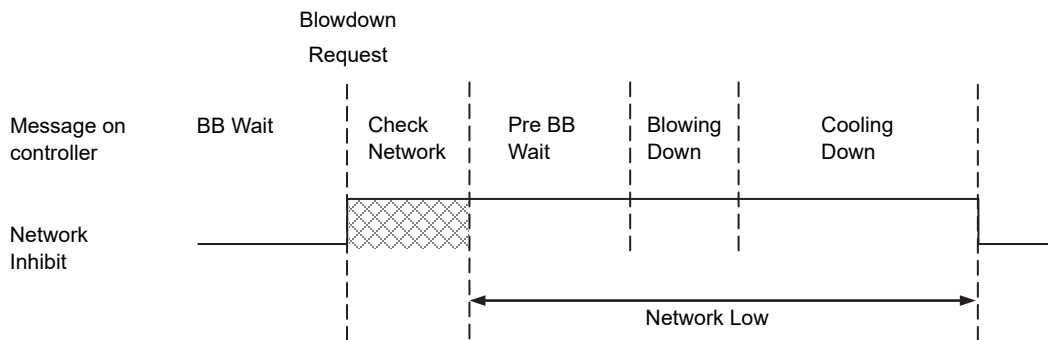

If another controller is holding the network (as determined by an appropriately configured digital input), the message 'Network Busy' is displayed and the NTWRK beacon lights.

If the network is not connected the message ' Network Open' is displayed

Non High Integrity Interlock Bus

Two digital I/O ports can be used, shorted together, on each instrument to implement the non high integrity bus interlock. One of the I/O must be configured as 'B.B. Inhibit Input' and the other as 'B.B. Inhibit Output'. Only two wires are used in this configuration to connect the Dig.Common terminal and the appropriate Dig I/O terminals of all controllers together.

As the name suggests this configuration is unable to determine reliably whether the signalling instrument is connected to the network.

Valve Switch Option

An option is provided to fit valve switches. A parameter 'Valve Switches' is available in the BOT BLOWDOWN parameter list which can be set to 'Yes' if the option is used. If a valve switch is fitted the controller will receive a 'Low' signal when the valve is closed (switch also closed) and constantly checks the status of the switch. If the line becomes broken and/or the valve is opened at the incorrect time, the network will show 'Busy' and indicate that there is a problem with the switch.

Each controller supports one valve and switch only.

Note: The current provided by the digital input is normally 1mA. This may not provide a large enough wetting current for some contacts other than gold. If this is the case an external supply of up to 30Vdc should be used with an appropriate pull up resistor to provide the necessary wetting current for the contacts being used.

Bottom Blowdown Parameters













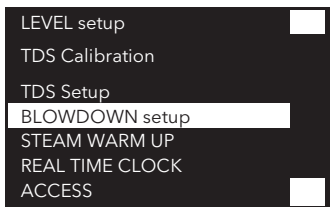

Up to three start times can be set to initiate the blowdown sequence in any boiler.

Table 113: This list allows you to set up the parameters for Bottom Blowdown		BOILER (Blowdown)		
Parameter Name	Parameter Description	Value	Default	Access Level
Inst Number	Instrument identification number. Used to generate an instrument ID specific delay timer to ensure that, if two blowdown times are set the same, then the two controllers will not initiate blowdown at the same time. 8 has the highest priority.	1 to 8	1	L3
BB1 Day	Day selected for Bottom Blowdown 1	Never Monday Tuesday Wednesday Thursday Friday Saturday Sunday Mon-Fri Mon-Sat Sat-Sun Every Day	Never	L3
BB1 Time	Time selected for Bottom Blowdown 1	0:00:00 to 24:00:00	0:00:00	L3
BB2 Day	Day selected for Bottom Blowdown 2	As BB1	Never	L3
BB2 Time	Time selected for Bottom Blowdown 2	0:00:00 to 24:00:00	0:00:00	L3
BB3 Day	Day selected for Bottom Blowdown 2	As BB1	Never	L3
BB3 Time	Time selected for Bottom Blowdown 3	0:00:00 to 24:00:00	0:00:00	L3
BB Duration	Blowdown duration for BB1, BB2 and BB3.	0:00:01 to 0:00:30	0:00:01	L3
Cool Duration	To set a cool down period to ensure that another controller does not blow down until the first has cooled	0:01:00 to 3:00:00	0:01:00	L3
Suspend Sr	Source wire for the suspend input. If the value returned by this wire is 'Yes' then the blowdown is suspended	Modbus address	---- None	Conf
Suspend	Suspend blowdown. If this parameter is not wired the user can set this manually. If the Suspend Src is used the wire will override this parameter.	No Yes	No	L3
Netwrk Src	Source wire for the digital input that represents the state of the network	Modbus address	---- None	Conf
Network Level	Indicates the state of the network	High Low		L3
Valve Switches	To select the valve switch option if the bottom blowdown valve has a limit switch fitted. If 'Yes' the next 3 parameters are made available	No Yes	No	Conf
VSwitch Src	Source wire for the valve switch limit input	Modbus address	---- None	Conf
VSwitch State	Shows if the switch is open or closed	Open Closed		L3
VSwitch Status	Valve switch status. Sets to 'Bad' if the switch shows open when it should be closed	Good Bad		L3
Netwrk Inhibit	Output wired to the AA relay to inhibit or show 'Busy'	Off Busy		L3
Blowdown O/P	Output wired to the valve I/O point of the TDS module	Off		L3
BB State	Indicates the current state of the blowdown sequence	BB Wait		L3
Alarm	Indicates if there is a problem with the network or the valve has failed to open	Off On		L3

Table 113:	This list allows you to set up the parameters for Bottom Blowdown		BOILER (Blowdown)	
Parameter Name	Parameter Description	Value	Default	Access Level
ACK Alarm Sr	Source wire for the alarm acknowledge. This will usually come from a self resetting user switch	Modbus address	---- None	Conf
ACK Alarm?	Alarm acknowledge. 'Yes' = acknowledge If the alarm acknowledge source is used the wire overrides this parameter.	No Yes		L3

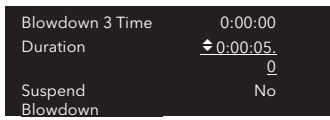



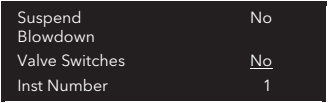

Example: To Perform a Boiler Blowdown

It is first necessary to set up the Real Time Clock if this has not already been done.
Then:

Do This	This Is The Display You Should See	Additional Notes
1. From any display press as many times  as necessary to display the page header menu 2. Press  or  to scroll to 'BLOWDOWN Setup'		
3. Press  to select the list of parameters 4. Press  again to edit the parameter 5. Press  or  to set the day		If required set up a Day and Time for a second and third blowdown. This allows up to three blowdowns on each boiler to be performed each day
6. Press  to select the 'Duration' of the blowdown 7. Press  or  to set the duration time		
8. Press  to select the 'Inst Number' 9. Press  or  to set an instrument number from 1 to 8		This is necessary so that the interconnection network knows which instrument has priority Note 1

Note 1:

If more than one boiler attempts a blowdown at the same time, then the 'Inst Number' parameter determines which has priority. 8 has the highest priority.

 Times may be set by holding the raise or lower buttons until the correct time has been set. Alternatively, hold down the scroll button  and use the raise/lower buttons  /  to move the cursor between hours and minutes then use  /  to change these independently.

TDS Input Module

For details of this module and calibration of Cable Offset, see the Module IO.

For Calibration of Conductance, see the Calibration.

Configuration Using Itools

Configuration of the instrument which has been described so far in this manual has been through the user interface of the controller. iTools provides a software platform for configuring Eurotherm instruments and also allows additional functions, such as naming of certain parameters and creating User Pages, to be performed. This chapter gives an introduction to using iTools to configure 2700 series instruments.

Further details are available in the iTools Help Manual Part No. HA028838 which can be downloaded from www.eurotherm.com. and provides further information on how to install, connect and generally operate iTools.

Programmer Editor

Introduction

The Programmer Editor is used to edit setpoint profiles for those devices which include a programmer. These pages are not intended to describe the Device Programmer itself, as this is explained in section Programmer Configuration.

Most operations require that the clone or instrument be in 'Configuration' mode. This mode can be entered either by clicking the right-hand button of the mouse over the required device panel view, then using the 'Set Access Level.' menu item, or by using the 'Access' tool button to toggle between 'Configuration' and 'Operator' (see 'Main toolbar').

Number of Programs

Version 6 and later of the Model 2704 include an asynchronous program mode which allows up to three program setpoints (PSPs) to be driven by separate programmers. The programs can be included in program groups, and the operator can then select and run that group of programs. Alternatively, the user can select a program for each PSP, and start them individually, or as a group.

There are 60 programs available to the user. In synchronous mode, these are called Program 1 to Program 60. In asynchronous mode, each of the PSPs is allocated 20 programs. These are variously called Programs 1 to 20, for each PSP, or Programs 1 to 20 for PSP1, Programs 21 to 40 for PSP2 and Programs 41 to 60 for PSP3.

Online / Offline Editing

If the editor is opened for a connected device (i.e. not a clone device), then any changes made to the program are written to the device, immediately. Normal instrument rules apply, so the same changes can be made to the running instrument via iTools, as can be made at the instrument's operator interface.

Online editing can be relatively slow, so it may be preferred to make the changes to a clone file, or to a previously saved file, and then to download the edited version to the instrument.

If the editor is opened for a clone device, the program created must either be saved to file, or downloaded to an on-line device.

Graph Printing

The graph (also called the 'chart') cannot be printed directly. Right clicking within the chart area, then selecting 'Copy Chart' saves a copy of the chart to the clipboard, whence it may be imported into Word or Excel, and then printed as usual (e.g. <Ctrl> + <P>).

Program Printing

The program can be printed by selecting the required segments and copying to the clipboard (e.g by using <Ctrl> + <C>). The program can now be imported into, say, Excel by using the Paste command (e.g. <Ctrl> + <V>), and printed as usual (e.g. <Ctrl> + <P>). It may be convenient to delete unused columns, rows etc. prior to printing.

Opening the Editor

The Program Editor is opened, for an actual device or for a clone by:

1. Clicking on the Programmer Editor tool button in the Views toolbar.
2. Selection of 'Programmer' in the 'Views' menu, or in the right mouse-click context menu.
3. Using the short cut <Alt> + <P>

The programmer window opens with the 'Segment Parameters' tab active. The figure below shows a new (untitled) clone in Configuration mode. By default, new programs have no segments defined for them. Real devices, or previously saved clones may have one or more segments defined, depending on programming history.

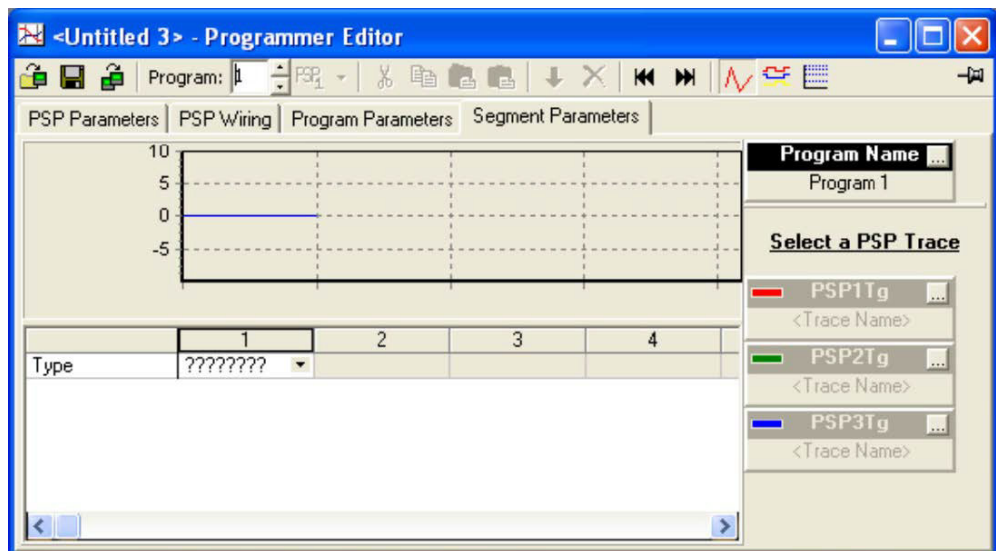

The parameter browse window contains the Program Setpoint (PSP) Parameters, allowing these to be edited (if read/write), without losing the segment parameters view.

PSP Parameters

When Access Level = 'Configuration', Program Setpoint parameters can be displayed by clicking on the 'PSP Parameters' tab. This produces a grid list of parameters which may be edited if Read/Write. Read only parameters appear in blue.

The 'PSP Parameters' tab does not appear for Access level = 'Operator'.

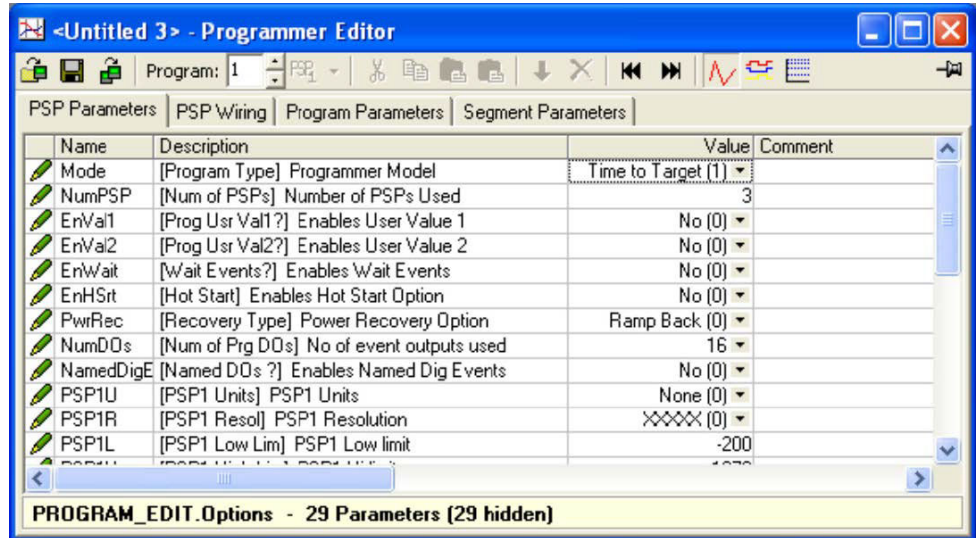

Hidden Parameters

'Hidden' parameters can be displayed by de-selecting 'Hide Parameters and Lists when Not Relevant' in the 'Parameter Availability settings...' item in the Options Menu. When displayed, such parameters have a coloured background, as shown in 'The Explorer Window' description.

PSP Wiring

When Access Level = 'Configuration', Program Setpoint wiring can be displayed by clicking on the 'PSP Wiring' tab. This produces a grid list of parameters the wiring for which may be edited as required.

The 'PSP Wiring' tab does not appear for Access level = 'Operator'.

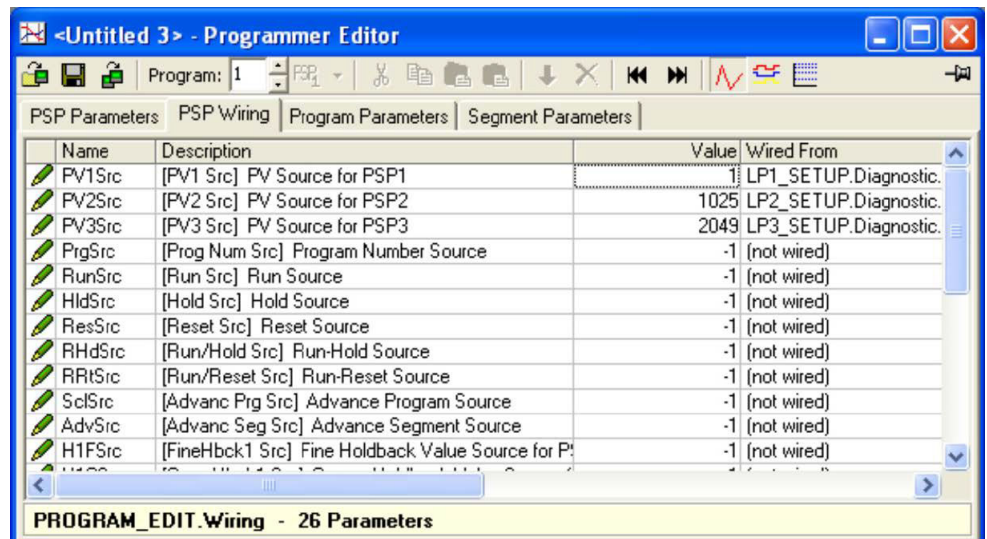

Program Parameters

Program parameters can similarly be displayed by clicking on the 'Program Parameters' tab. Read only parameters appear in blue.

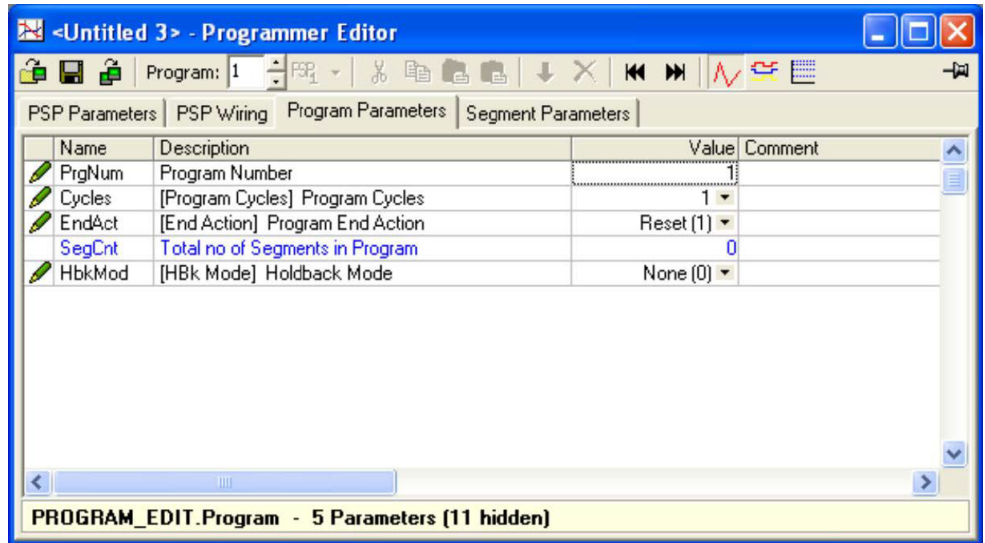

Note: The device (real or clone) must be in configuration mode before editing can be carried out. Configuration mode can be entered either by clicking the right-hand button of the mouse over the required device panel view, then using the 'Set Access Level...' menu item, or by using the 'Access' tool button to toggle between 'Configuration' and 'Operator' (see 'Main toolbar').

Program and PSP Names

The program name can be edited by double-clicking anywhere in the Program Name area, or single clicking on the ellipsis box (as shown) then entering a new name, of up to 16 characters, in the text entry box which appears. The program name applies only to the program in which it is entered.



The Program Setpoint (PSP) names (Trace Names) are changed in a similar way. The PSP names entered here are common to all programs i.e. if a name is edited in one program, then the new name appears in all other programs. See also 'Asynchronous Programmer'.



Notes:

1. The number of PSPs is defined by 'NumPSP' in the 'PSP Parameters' tab.
2. The colours in the PSP faceplate header bars are reflected in the Segment list and on the graph, for ease of identification.
3. Clicking on a faceplate highlights the selected PSP trace in the graph. See 'The Graph' for more details.
4. To improve clarity, if the PSP values are widely different, then one or more of the traces will be drawn to a different scale (displayed scale is x10 or x100 actual value). The scaling factor appears in the faceplate. See 'The Graph' for more details.

Segment Parameters

See the separate topic 'Segment Parameters' for details of the 'spreadsheet' view.

The Graph

See separate topic 'The Graph' for details of the graphical display.

Programmer Toolbar

See 'Programmer toolbar' for details.

Programmer Menu

See 'Programmer Menu' for details

Adding, Inserting and Deleting Segments

FIRST SEGMENT

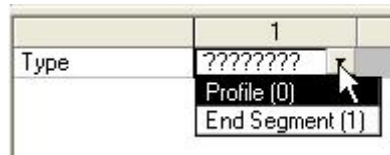

Clicking on the arrow head, produces a list of available segment types. All Segments, except the first (illustrated above), also include 'Go Back' as a segment type. Once a type has been selected the display changes to include the relevant parameters for the selected segment type. The figure below shows a partial parameter list for a Ramp Rate type program.

	1	2
SegNo	1	
UsrTxt	Default Text	
Type	Profile (0)	?????????
PSP1Tp	Step (1)	
PSP1Tg	0	
PSP2Tp	Step (1)	
PSP2Tg	0	
PSP3Tp	Step (1)	
PSP3Tg	n	

ADDING SEGMENTS

To add a new segment, the arrow head to the right of the ???????? Type field can be clicked (as shown below), and once a type has been selected, the new segment parameters appear, their values based on the previous segment. The ???????? field does not appear if the final segment is of type 'End Segment'.

The two views below show typical parameter lists for the two 'Modes' of operation viz: 'Ramp Rate' and 'Time to Target'. Mode selection is defined by 'Mode' in the 'PSP Parameters' tab. Other parameters appear only if the relevant options have been enabled, also via the 'PSP Parameters' tab. The parameters themselves are described in a separate topic: 'Segment parameters'.

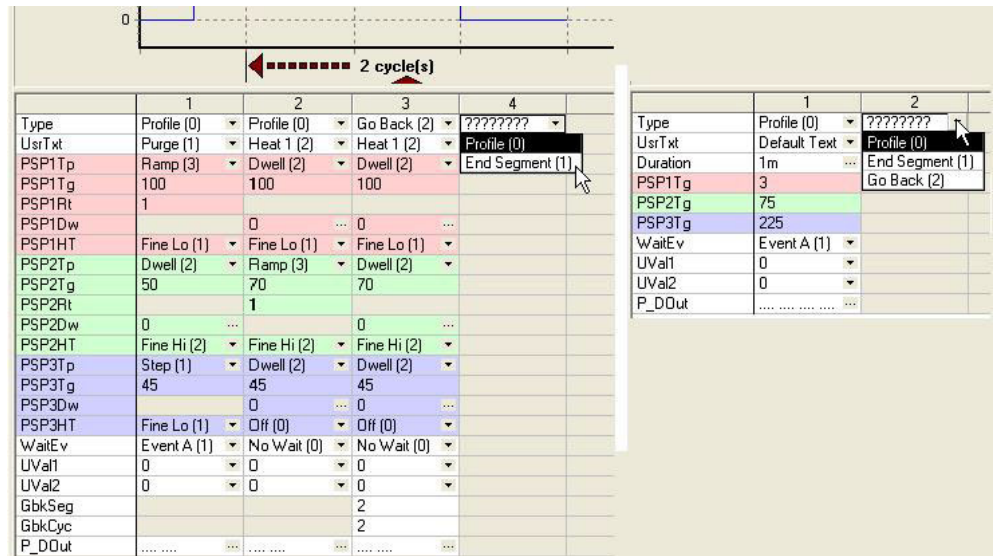

INSERTING SEGMENTS

To insert a segment, highlight the segment immediately to the right of where the new segment is to appear, then:

1. Click on the 'Insert' tool button  in the Programmer toolbar,
2. Select 'Insert Segment' from the main Programmer menu or the right-click (context) menu,
3. Use the shortcut <Insert>.

A new segment, identical with the one highlighted, appears to the left of the highlighted segment.

An alternative is to highlight one or more segments, copy them to the clipboard and then paste them into the required position. Again, the inserted segments appear to the left of the highlighted segment. This cut and paste technique can be used to copy portions of one program into another, either within one instrument or clone, or from one to another.

Copying is done by highlighting the required segments, then:

1. Clicking on the 'Copy' tool button  in the Programmer toolbar,
2. Selecting 'Copy' from the main Programmer menu or the right-click (context) menu,
3. Using the shortcut <Ctrl> + <C>.

Pasting is done by highlighting the segment to the right of the insertion point, then:

1. Clicking on the 'Paste Insert' tool button  in the Programmer toolbar,
2. Selecting 'Paste Insert' from the main Programmer menu or the right-click (context) menu,
3. Using the shortcut <Ctrl> + <V>.

It is also possible to replace one or more segments with the same number of replacement segments. This is done by copying and pasting as described above, but

using the 'Paste Over' tool button  or menu item, rather than 'Paste Insert', shortcut <Shift> + <Ctrl> + <V>. The number of segments highlighted to be pasted over must be the same as the number of segments on the clipboard.

DELETING SEGMENTS

Segments can be deleted in the following ways;

1. By selecting one or more segments, then clicking on the Delete tool button .
2. By selecting one or more segments, then selecting 'Delete Segment' from the right-click (context) menu or the main 'Programmer' menu.
3. By selecting one or more segments, then using the shortcut <Ctrl> + <Delete>.
4. By changing segment type to 'End'. This deletes all segments to the right of the new End segment.

Segment Type

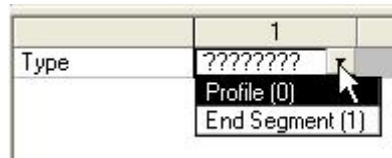

Clicking on the arrow head, produces a list of available segment types. All Segments except the first (illustrated above) also include 'Go Back' as a segment type. Once a type has been selected the display changes to include the relevant parameters for the selected segment type.

The two views below show typical segment parameter lists for the two 'Modes' of operation viz: 'Ramp Rate' and 'Time to Target'. Mode selection is defined by 'Mode' in the 'PSP Parameters' tab.

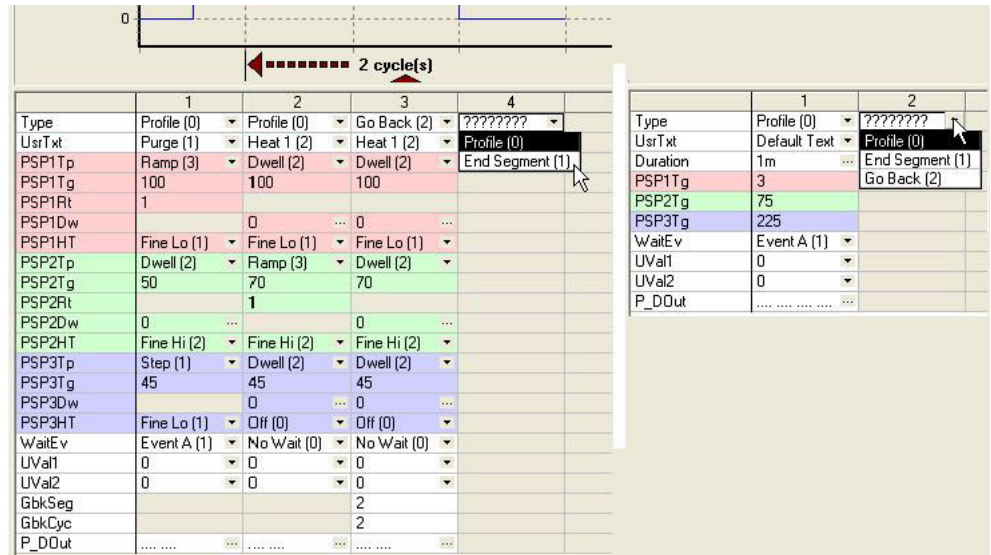

UsrTxt

User Text.

Clicking on the arrow head to the right of 'Default Text', displays a picklist of text strings, one of which may be selected for this segment. These text strings are edited in the INSTRUMENT/ User_Text subfolder.

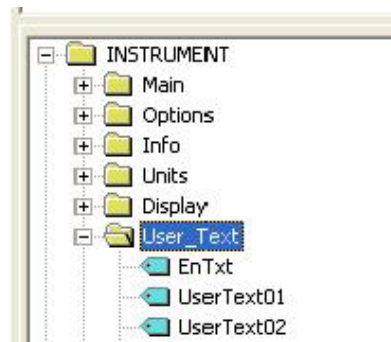

Type

Select a segment type from the picklist, as shown above.

End segment action is set in 'EndAct' in the 'Program Parameters' tab to be either 'Reset' or 'Dwell'.

For Go back details, see GbkSeg, below.

Duration

For Time to Target Mode programs only.

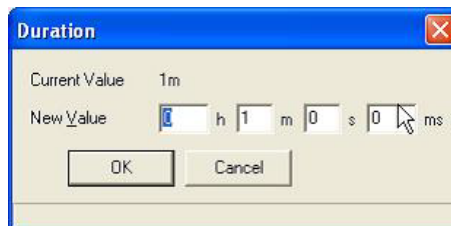

By clicking on the ellipsis button next to 'Duration', the Duration entry box (shown above) appears. This allows the user to set a time for the segment to complete its task.

PSPnTp

Segment type ('n' = 1, 2 or 3).

For Ramp Rate mode only.

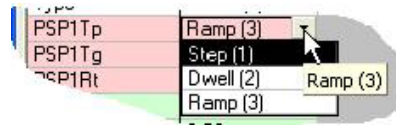

Select a Ramp Type of Step, Dwell or Ramp. Subsequent PSP parameters vary according to the Type selected.

PSPnTg

Segment target ('n' = 1, 2 or 3).

This allows the user to type in a target value to which the segment is to ramp. For mode = Time to target, the ramp duration is entered using the 'Duration' parameter described above. For Ramp Rate mode programs, the ramp duration is set in PSPnRt (below).

PSPnRt

Ramp Rate ('n' = 1, 2 or 3).

For Mode = 'Ramp Rate' and PSPnTp = 'Ramp' only.

The speed at which the ramp is to take place is entered here. The units are set as per second, per minute or per hour in 'RateU' to be found in the Program Parameters tab list.

Example: With 'RateU' set to 'per minute', an entry of '2' would mean the ramp takes place in 30 seconds.

An entry of '3' would mean the ramp would complete in 20 seconds, and so on.

PSPnDw

Dwell Duration ('n' = 1, 2 or 3).

For Mode = 'Ramp Rate' and PSPnTp = 'Dwell' only.

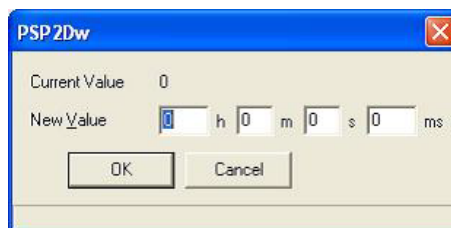

Clicking on the ellipsis button next to the dwell value field causes the Dwell Time entry box (shown above) to appear. This allows the user to set a time for the segment to complete its task.

This value may affect the timing of other PSPs.

PSPnHT

Holdback Type ('n' = 1, 2 or 3).

In holdback mode, the program is 'frozen' if the measured process value (PV) does not track the setpoint (SP) within the user-defined amount. The actual values associated with the list items are editable in the 'Program Parameters' tab list (H1FVal, H2FVal, H3FVal and H1CVal, H2CVal, H3CVal, where 1, 2 and 3 represent the relevant PSP number).

If holdback is enabled (HbkMod in the 'Program Parameters' Tab list), and 'Per Segment' selected, then the user can select the required holdback time for this segment from a drop-down list containing the following: Off, Fine Lo, Fine Hi, Fine Band, Coarse Lo, Coarse Hi and Coarse band.



If holdback 'Per Program' is selected (HbkMod in the 'Program Parameters' tab list), then the user can select the required holdback time for all segments in the program from drop-down lists called PSP1HT, PSP2HT and PSP3HT, also in the 'Program Parameters' tab list. The drop-down lists contain the same items as listed above.

P_DOut

Event outputs are used to drive Relay, Triac or Logic outputs, according to the modules fitted.

The Event Output Status Word (P_DOut) is displayed graphically as two horizontal lines each of up to 16 dots where the dots representing Event output 1 are leftmost. The number of dots in the lower line matches the number of Event outputs entered in the 'NumDos' parameter in the 'PSP Parameters' tab. (Normally, only the maximum number of Event outputs needed is typed-in, in order to minimise display complexity at the 2704 user interface.)

The dots in the upper line show which Event Outputs are to be active, whilst the associated segment is active.

The figure below shows that this segment is to have Event Outputs 1, 3, 5 and 7 active.



Hovering the cursor over the ellipsis button displays the status in logical format as shown below, where 1 = active and 0 = inactive.

Clicking on the ellipsis button allows the user to edit the status of each Event Output. The value of the status word is the sum of all the bits set. In this example, with Bits 1, 3, 5 and 7 set, the value of the status word is $1 + 4 + 16 + 64 = 85$.

P_DOut	Event A (1)	01: 1
WaitEv	Event A (1)	02: 0
UVal1	0	03: 1
UVal2	0	04: 0
		05: 1
		06: 0
		07: 1
		08: 0
		09: 0
		10: 0
		11: 0
		12: 0
		13: 0
		14: 0
		15: 0
		16: 0

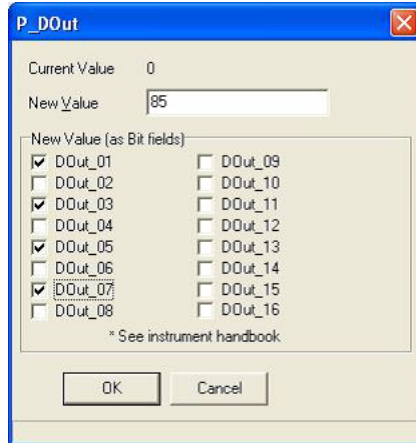

Event No.	Value when set	Event No.	Value when set
DOut_01	1	DOut_09	256
DOut_02	2	DOut_10	512
DOut_03	4	DOut_11	1024
DOut_04	8	DOut_12	2048
DOut_05	16	DOut_13	4096
DOut_06	32	DOut_14	8192
DOut_07	64	DOut_15	16384
DOut_08	128	DOut_16	32788

WaitEv



On completion, the segment waits for as long as the selected Wait Event is active.

UVal1/UVal2

Allows the selection of a User Value to be made. User values are associated with the Pattern Generator and are described in section Program User Values.

GbkSeg

For 'Go Back' segments only, this allows the user to define the segment to which the program is to go back. Once defined, a graphical interpretation is displayed just below the graph, showing which segment is to be returned-to and how many times the segment(s) included in the go back section are to be run (see GBkCyc, below).

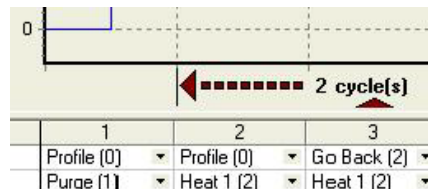

GbkCyc

For 'Go Back' segments only, this allows the user to define how many times the segment(s) included in the go back section are to be run (see also GBkSeg, above).

In the example above, segments 2 and 3 run once, and are then repeated twice before segment 4 runs.

In the example below, segments 1 to 5 run once, and are then repeated 5 times (i.e. they are run 6 times in all) before segment 6 executes.

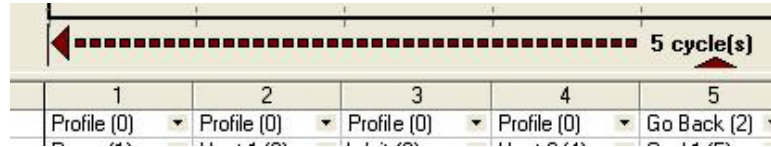

The Graph

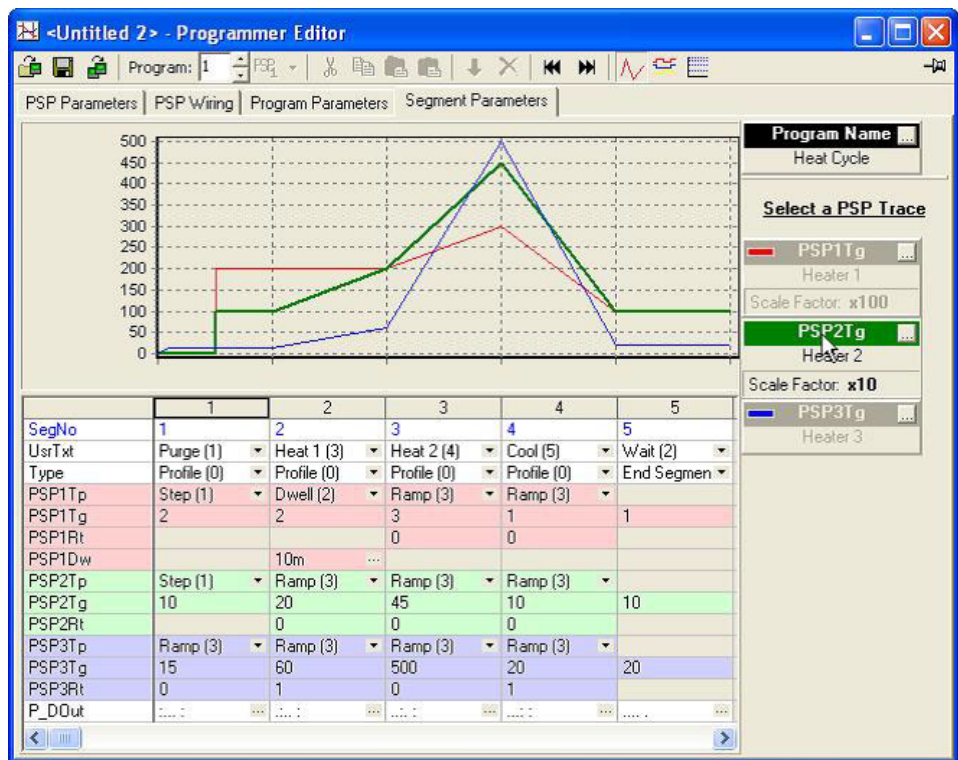

The graph displays the setpoint program segments. As can be seen from the figure above, the traces and parameters reflect the colours of the PSP faceplates.

Clicking on a faceplate (PSP2 in the example above) causes both the faceplate and the associated trace to be highlighted.

As can be seen from PSP1 and PSP 2 in the example above, if traces have widely different values, then the traces with lower values are 'magnified' so that they can be seen more clearly. In the example above, PSP1 trace is magnified by 100 and PSP2 trace is magnified by 10. Obviously, the values in the graph y-axis must be divided by the same factors to give correct values.

A Graph may be printed by pasting it into a standard spreadsheet, and printing it from there. See 'Graph printing' in the Introduction to the Programmer Editor.

LOGARITHMIC SCALES

Scales can be chosen as either linear or logarithmic, by using the 'logarithmic' tool

 (shortcut <Ctrl> + <M>) to switch between the two scale types.

Digital Graphs

The examples above show analogue graphs. If Event Outputs are enabled, a digital view of the program can be displayed, by clicking on the 'Digital' tool button  , or by using the shortcut <Ctrl> + <D>. The example below shows a display for five Event outputs. See 'P_DOut' in 'Segment Parameters' for more details.

To return to the analogue display, the 'Analog' tool button  should be clicked on.

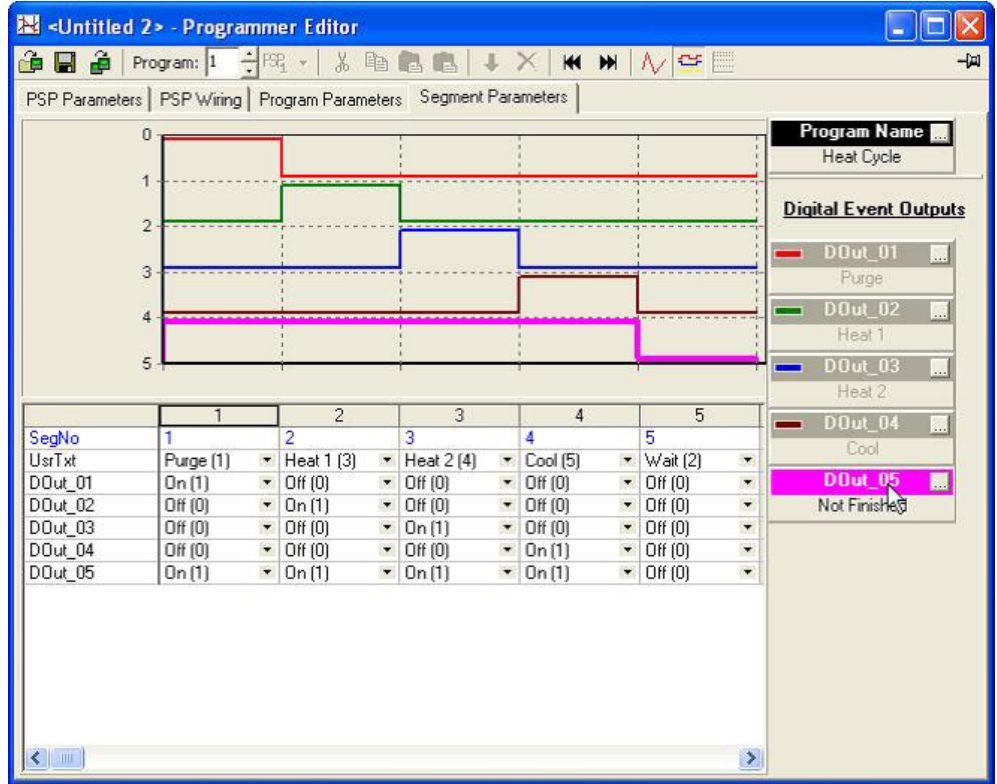

Asynchronous Programmer

Version 6 and later of the Model 2704 include an asynchronous program mode which allows up to three program setpoints (PSPs) to be driven by separate programmers. The programs can be included in program groups, and the operator can then select and run that group of programs. Alternatively, the user can select a program for each PSP, and start them individually, or as a group.

Notes:

1. Enabling asynchronous mode causes all existing programs to be deleted, so if the existing programs are to be retained, they should be saved.
2. After changing mode, it may be necessary to close, then re-open the programmer before the changes take full effect.

Entry to Asynchronous Mode

Once the instrument or clone is active, the Instrument/Options/Asynch can be double clicked in the parameter browse window, and 'Asynchronous' selected in the resulting picklist.

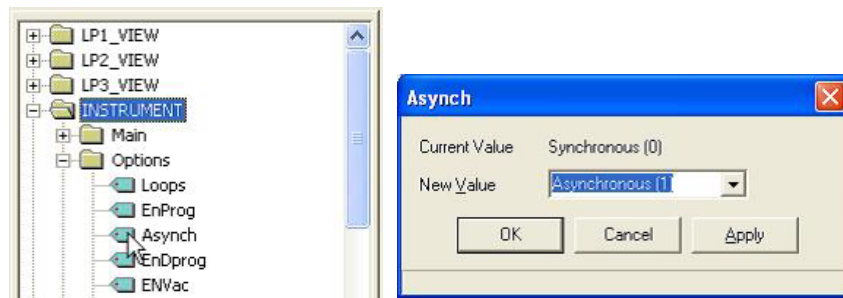

Alternatively, the value can be changed from the Options tab of the Instrument function block view, called by double clicking on Instrument in the Tree view:

Name	Description	Units	Address	Value	Wired From
Loops	[Num of Loops]	Number of c	10424	2	
EnProg	[Programmer]	Programmer en	10416	Enabled (1)	
Asynch	[Prog Mode]	Defines Progra	5922	Asynchronous (1)	
EnDprog	[Digital Prog]	Digital Program	10431	Synchronous (0)	
ENVac	[Vacuum]	Vacuum Enable	10432	Asynchronous (1)	
EnZirc	[Zirconia]	Zirconia enable	10417	Disabled (0)	
EnHumd	[Humidity]	Humidity enable	10418	Disabled (0)	

A similar process is carried out to return to Synchronous mode should this be required.

Using the Editor in Asynchronous Mode

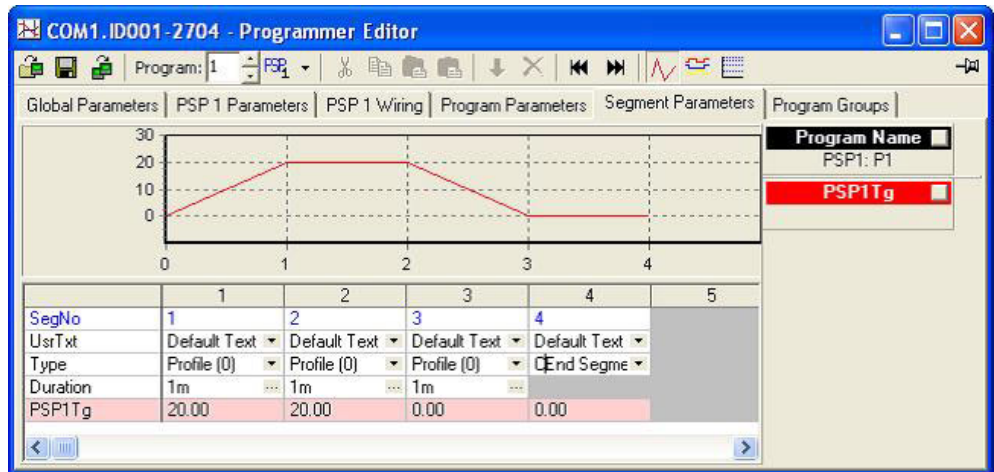

Asynchronous mode editing is similar to Synchronous mode editing, described in 'Program editing'. The basic procedure is as follows:

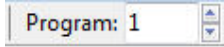
1. Select the 'Global Parameters' tab and set the program mode (Mode) to 'Ramp Rate' or 'Time-to-Target' as required. Set the number of PSPs (NumPSP) to 1, 2 or 3, as required.
2. Select the 'Segment Parameters' tab. If necessary, select PSP1 using the 'Select asynchronous PSP' tool .
3. Select the required program number using the 'Program Number tool' .
4. Create the required PSP program, as described in 'Program editing'.
5. Repeat for all required PSPs and Programs.
6. Select the 'Program Groups' tab and assign the PSPs to the required Program groups.

Differences between Synchronous and Asynchronous

The following sections describe the differences between the two modes.

Parameter List changes

1. The 'PROGRAM_RUN' list is removed.
2. The three PSP option parameters are shown in 'PSP1-PROFILE', 'PSP2_PROFILE' and 'PSP3_PROFILE'.
3. Programmer options appear in 'PSP1-PROFILE', 'PSP2_PROFILE' and 'PSP3_PROFILE', not in 'PROGRAM_EDIT'.
4. Groups of programs are created and controlled via 'PROGRAM_EDIT/Groups' and 'PROGRAM_EDIT/Group names'

Number of Programs

There are 60 programs available to the user. In synchronous mode, these are called Program 1 to Program 60. In asynchronous mode, each of the PSPs is allocated 20 programs. These are variously called Programs 1 to 20, for each PSP, or Programs 1 to 20 for PSP1, Programs 21 to 40 for PSP2 and Programs 41 to 60 for PSP3.

Operator interface

1. An extra tool button is enabled on the toolbar, allowing the user to select PSP1, 2 or 3 for programming.

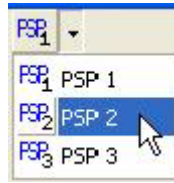

2. Only one PSP is shown, because each asynchronous program can have only one PSP.
3. The 'PSP Parameters' and 'PSP wiring' tab names include the currently selected PSP number. The faceplate is always PSP1.
4. A new tab 'Global Parameters' appears. This tab contains the parameters that are associated with all PSPs.
5. A new tab 'Program Groups' appears which allows the user to allocate the PSPs to program groups. Thus when a program group is run, the PSPs which have been allocated to that group are run. In the example below, if program group 3 were chosen, then PSP1 Program 1, PSP2 Program 5 (25) and PSP3 Program 5 (45) would be run.

	PSP1	PSP2	PSP3
Group 1	PSP1: P1 (1)	PSP2: P1 (21)	PSP3: P1 (41)
Group 2	PSP1: P2 (2)	PSP2: P3 (23)	PSP3: P4 (44)
Group 3	PSP1: P1 (1)	PSP2: P5 (25)	PSP3: P5 (45)
Group 4	PSP1: P10 (10)	PSP2: P7 (27)	PSP3: P10 (50)
Group 5	Not Used (0)	Not Used (20)	Not Used (40)
Group 6	Not Used (0)	Not Used (20)	Not Used (40)
Group 7	Not Used (0)	Not Used (20)	Not Used (40)
Group 8	Not Used (0)	Not Used (20)	Not Used (40)
Group 9	Not Used (0)	Not Used (20)	Not Used (40)
Group 10	Not Used (0)	Not Used (20)	Not Used (40)
Group 11	Not Used (0)	Not Used (20)	Not Used (40)
Group 12	Not Used (0)	Not Used (20)	Not Used (40)
Group 13	Not Used (0)	Not Used (20)	Not Used (40)
Group 14	Not Used (0)	Not Used (20)	Not Used (40)
Group 15	Not Used (0)	Not Used (20)	Not Used (40)

PSP / Program / Group relationship

The twenty programs associated with each PSP are independent of each other, and of all the programs associated with other PSPs, except in the relationship defined in the Program Groups database. For example, PSP1 Program 1, PSP2 program 1 and PSP3 program 1 are entirely independent, unless they are placed in the same Program group.

Saving / Loading asynchronous programs

Each program is saved and loaded individually. It is not possible to save or load groups of parameters in one step.

Groups are saved in the instrument clone file. The editor cannot save groups separately.

User Page Editor

2704 User Page Editor

INTRODUCTION

The User Page Editor provides templates to allow the user to create screens to appear at the 2704 display, by assigning parameters to locations on the screen. 'Live' mode simulates the appearance of the actual display.

There are eight user-definable pages available, and each page can be configured to show parameter values in one of seven styles. Pages are edited in the User Screen Tab. The User List tab displays up to ten 'Promote Parameters'.

The User Page Editor is opened by:

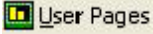
1. Clicking on the 'User Pages Editor' tool button  in the 'Views' toolbar.
2. Selecting 'User Pages' from the Views menu
3. Using the shortcut <Alt> + <U>
4. Right clicking over the relevant instrument faceplate, and selecting 'User Pages' from the resulting context menu.

The editor opens in whatever style Page 1 is set to. For new clones or instruments, the default style is Parameter List.

ADDING PARAMETERS

No matter which style of display is chosen (apart from blank), and providing the conditions below are met, parameters can be dragged from anywhere in iTools into any parameter position. If a parameter already exists in the dragged-to location, it is overwritten.

Note: The dragged-to screen location becomes the 'selected parameter'.

Alternatively, the Edit wiring tool button , the 'Pages' menu item in the iTools main menu, the context menu (right click) or the shortcut <Ctrl> + <E> can be used.

Conditions

1. The device must be in configuration mode, otherwise 'Edit' mode is not available.
2. The User screen must be in Edit mode, not in Live mode. Live and edit are

toggled between using the 'Show live data'/'Return to editor' tool button  in the toolbar, by selecting 'Show live data'/'Return to editor' from the 'Pages' menu, or by using the shortcut <Ctrl> + <L>.

SELECTED PAGE

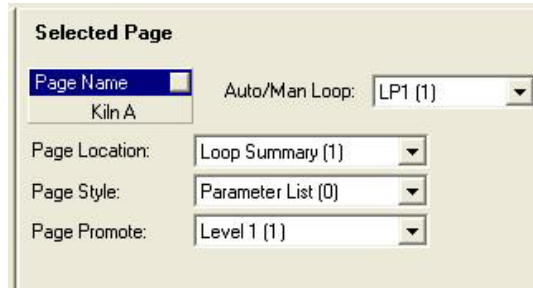

A panel to the right of the device 'faceplate' allows Page details to be configured.

Page Name

Clicking in this area calls the user text dialogue box, allowing the user to select one of 100 text strings for the page name. These text strings are entered in the Instrument/User_Text folder in the parameter browse list.

Auto/man Loop:

Allows the user to select None, LP1, Lp2 or Lp3. Defines which page the Auto/Man(ual) key is to be associated with.

Page Location:

Select 'None', 'Loop Summary' or 'Main Page' for the User Page location at the 2704 user interface.

None = Page is hidden

Main Page = Page name appears in the main configuration menu, immediately below 'User Pages'.

Loop Summary = Page found by one or more operations of the 'Loop' front panel control button.

Page Style:

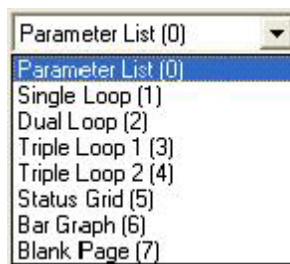

Allows the user to select a style for the selected user page. See Parameter List style, Single Loop style, Dual Loop style, Triple Loop style 1, Triple Loop style 2, Status Grid style, Bar Graph style, for further details.

The Blank Page style is used to 'hide' other displays until needed.

Note: The Parameter List style differs from other styles in that it shows the 'Promotion Parameter' list in the main display area (i.e. the user screen).

Each of the other styles (except 'Blank') includes a display area, near the bottom of the screen, in which one of the promotion parameters is displayed. The default is the first parameter in the promotion Parameter List, but scroll buttons allow any one of the 10 parameters to be chosen. The full list can be viewed by clicking on the 'User List' tab.

Page Promote:

Allows the user to select the access level(s) at which the page may be viewed.

Graph Style:

This appears only for User pages incorporating bargraphs etc.

Allows 'Absolute' or 'Error' to be selected for graphical elements.

Absolute starts at the bottom and grows upwards.

Error starts at zero, but Error type graphs are scaled by GraphLo and GraphHi (in the 'Selected Parameter' area), thus allowing the zero point to be offset to allow positive and negative excursions to be shown. The Graph end points can also be set up in the 'LPn_SETUP/Display' folder, parameters GraLo and GraHi.

Section name:

These controls appear only if the page style is dual or triple loop. Double clicking anywhere in the control or single clicking in the ellipsis box allows the user to select a text string from the User_Text subfolder, to act as a section name.

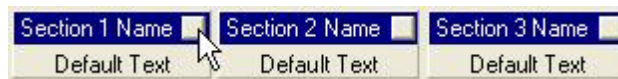

SELECTED PARAMETER

This panel area displays details of the currently selected (clicked-on) parameter.

User Text

Clicking in this area calls the user text picklist, allowing the user to select one of 100 text strings for the parameter name. These text strings are entered in the Instrument/User_Text subfolder in the Parameter Browse List.

The user text dialogue box can also be called by clicking on the 'Edit user text for

selected parameter' tool , or by using the short cut <Ctrl> + <T>. This allows an individual entry to be selected or edited, to become the new parameter name.

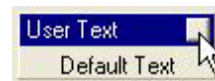

Graph Lo / Graph Hi

These controls appear only for 'Bargraph' display style and allow endpoints for the relevant parameter's graphical display to be entered.

Access

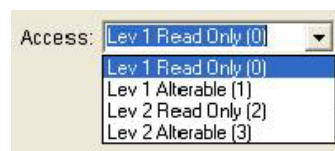

This field appears only in the User List Tab View, or for 'promote parameters' and allows the user to select a required access level for each parameter. Access levels and their passwords are set in the ACCESS folder.

Promote Parameters

The (up to 10) parameters displayed when the 'User List' tab is clicked-on are called Promote parameters. In each style (except 'Parameter List' and 'Blank Page') there is an area near the bottom of the User Screen display in which one of these Promote Parameters is displayed.

As shown in the figure below (for edit mode), the User list parameter number (2) and the parameter mnemonic (AL_2) appear, along with a pair of scroll buttons. These scroll buttons are used to select the required promote parameter for display. Alternatively, a replacement parameter can be displayed by dragging it into the display area. Such an action automatically updates the User List.

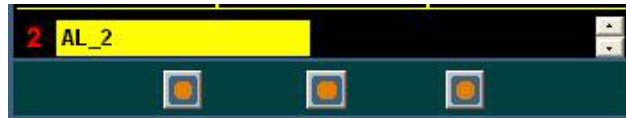

The 'Live' mode display is similar, but the User List parameter number disappears, and the parameter name and value are displayed instead of just the mnemonic. Again, the scroll buttons are used to select the required promote parameter for display.

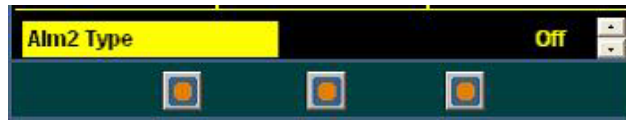

User List Tab

Note: the figure below is a composite view of the User List (Edit mode) - it is not possible to view the full width of this window in iTools.

No.	Wired From	User Text	Promote Access
1	LP1_SETUP.Diagnostic.PV	Inflow Temp 1	Lev 2 Alterable (3)
2	LP1_VIEW.Main.tSP	Inflow Temp 1	Lev 2 Alterable (3)
3	LP1_SETUP.Diagnostic.wSP	Inflow Temp 1	Lev 1 Read Only (0)
4	LP1_SETUP.Output.m-A	Inflow Temp 1	Lev 1 Read Only (0)
5	LP2_SETUP.Diagnostic.PV	Outflow Temp 1	Lev 2 Alterable (3)
6	LP2_VIEW.Main.tSP	Outflow Temp 1	Lev 2 Alterable (3)
7	LP2_SETUP.Diagnostic.wSP	Outflow Temp 1	Lev 1 Read Only (0)
8	LP3_SETUP.Diagnostic.PV	Reactor 1a	Lev 2 Alterable (3)
9	LP3_VIEW.Main.tSP	Reactor 1a	Lev 2 Alterable (3)
10	LP3_SETUP.Diagnostic.wSP	Reactor 1a	Lev 1 Read Only (0)

The User List Tab allows all the promote parameters for the associated User Page to be displayed simultaneously.

In Edit mode, User Text and Access level can be edited using the 'Selected Parameter' panel. In Live Data mode, the list appears as shown below, giving the parameters' User Text names and associated live values.

No.	Name	Value
1	Inflow Temp 1	1529.0
2	Inflow Temp 1	1000.0
3	Inflow Temp 1	1000.0
4	Inflow Temp 1	Auto
5	Outflow Temp 1	423.0
6	Outflow Temp 1	500.0
7	Outflow Temp 1	500.0
8	Reactor 1a	697.0
9	Reactor 1a	700.0
10	Reactor 1a	700.0

Styles

BARGRAPH

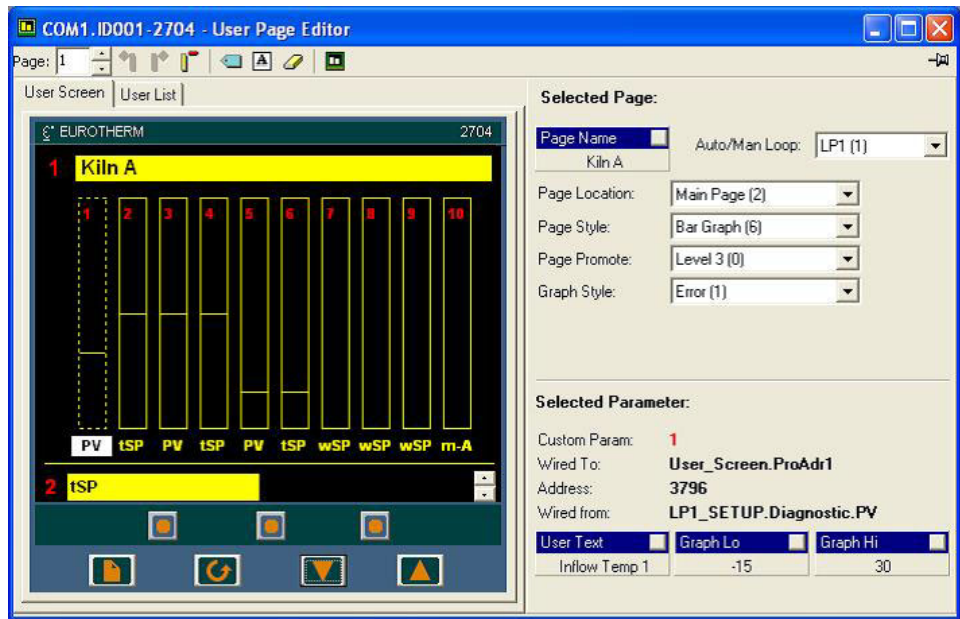

This provides a view of a Bar Graph style, used to display analogue values. Parameters can be dragged to the relevant positions on the page, or they can be inserted using the Edit wiring tool button or 'Pages' menu item or by using the shortcut <Ctrl> + <E> or the Context (right-click) menu.

A maximum of 10 bars can be shown. Bars can be added (up to a maximum of 10) or deleted, using the toolbar tool buttons, or the relevant selections from the Pages menu or Context menu.

The figure above shows the style, in edit mode. The live data screen is described below.

As can be seen above, the display screen is divided into a number of areas. Each of these areas is covered by a separate topic:

1. The user screen itself which shows a Model 2704 faceplate. Parameters can be dragged into the display from any other area of iTools.

The Control buttons (below) can be used to navigate through the pages and the page items. The 'Go to Menu' button calls the main menu, from which any one of the eight User Pages can be selected for view, either by double clicking on the menu item, or by clicking on the 'Select Page' control button.

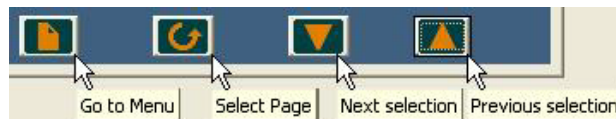

2. Selected Page area. This allows the currently selected page to be configured. See Selected Page for more details.
3. Selected Parameter area. This gives details of the currently selected parameter. See Selected Parameter for more details.

4. User pages toolbar  . See 'Pages Toolbar' for further details.

5. User List Tab. See 'User List Tab' for further details.

6. Promote parameter. See 'Promote Parameters' for details.

LIVE DATA SCREEN

The live data screen shows how the bargraph user screen appears on the instrument.

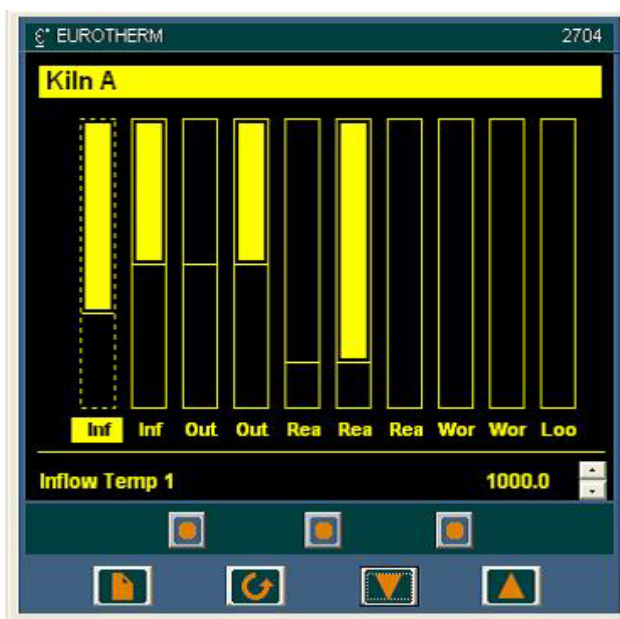

As can be seen, the live data screen is similar to the Edit screen, but this time the bargraphs are active.

Default Parameter names are displayed or, if any parameter has been re-named, then the new name appears here.

See 'Selected Parameter' for details of how to re-name the parameter.

Promotion Parameters

The User List tab contains up to 10 parameters, which may be the same as or different from the parameters at the display. These parameters are called Promotion parameters, and appear in the Parameter List User page.

One of these parameters is displayed at the bottom of the device screen, as shown above. The up/down arrows allow the user to scroll through the promotion parameters, one at a time, as required.

DUAL LOOP STYLE

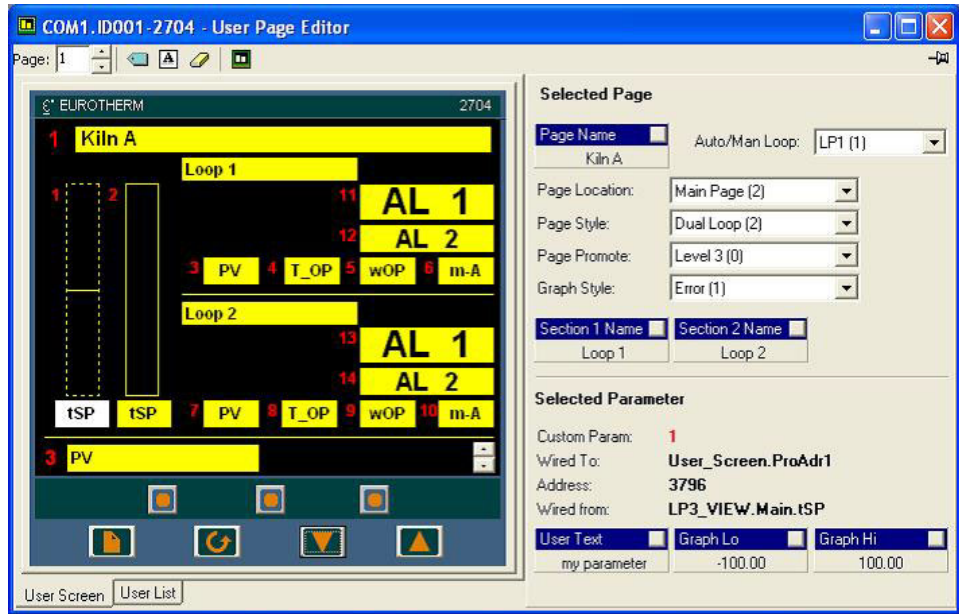

This provides a view of a dual loop program. Parameters can be dragged to the relevant positions on the page, or they can be inserted using the Edit wiring tool button or 'Pages' menu item or by using the shortcut <Ctrl> + <E>.

The figure above shows Dual Loop style, in edit mode. The live data screen is described below.

As can be seen above, the display screen is divided into a number of areas. Each of these areas is covered by a separate topic:

1. The user screen itself which shows a Model 2704 faceplate. Parameters can be dragged into the display from any other area of iTools.

The Control buttons (below) can be used to navigate through the pages and the page items. The 'Go to Menu' button calls the main menu, from which any one of the eight User Pages can be selected for view, either by double clicking on the menu item, or by clicking on the 'Select Page' control button.

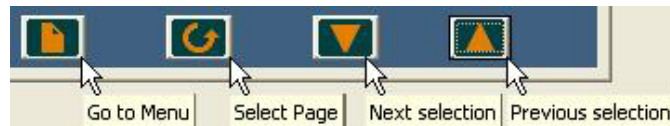

2. Selected Page area. This allows the currently selected page to be configured. See Selected Page for more details.
3. Selected Parameter area. This gives details of the currently selected parameter. See Selected Parameter for more details.

4. User pages toolbar . See 'pages Toolbar' for further details.
5. User List Tab. See 'User List Tab' for further details.
6. Promote Parameter. See 'Promote Parameters' for details.

LIVE DATA SCREEN

The live data screen shows how the dual loop user screen appears on the instrument.

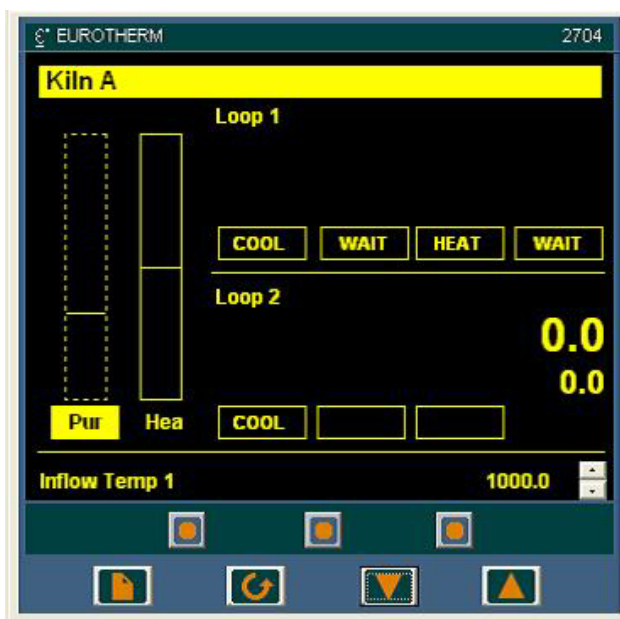

As can be seen, the live data screen is similar to the Edit screen, but this time with instantaneous values displayed for each parameter.

Default Parameter names are displayed or, if any parameter has been re-named, then the new name appears here.

See 'Selected Parameter' for details of how to re-name the parameter.

PARAMETER LIST STYLE

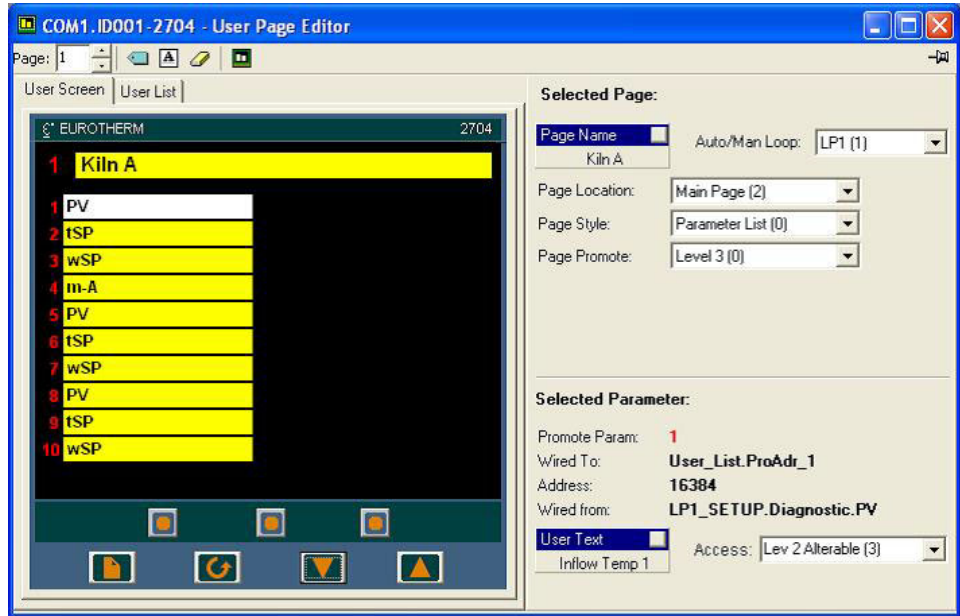



The figure above shows a parameter list style page, in edit mode. The live data screen is discussed below.

As can be seen above, the display screen is divided into a number of areas. Each of these areas is covered by a separate topic:

1. The user screen itself which shows a Model 2704 faceplate with space for up to 10 'promote parameters'. Parameters can be dragged into the display from any other area of iTools. This list and the User list are identical for this display style.

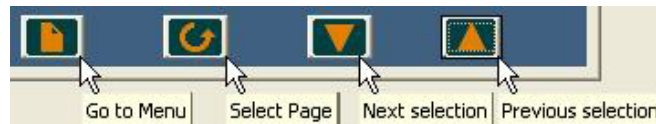
The Control buttons (below) can be used to navigate through the pages and the page items. The 'Go to Menu' button calls the main menu, from which any one of the eight User Pages can be selected for view, either by double clicking on the menu item, or by clicking on the 'Select Page' control button.



2. Selected Page area. This allows the currently selected page to be configured. See Selected Page for more details.
3. Selected Parameter area. This gives details of the currently selected parameter. See Selected Parameter for more details.
4. User pages toolbar . See 'Pages Toolbar' for further details.
5. User List Tab. See 'User List Tab' for further details.

LIVE DATA SCREEN

The live data screen shows how the parameter list user screen appears on the instrument.



As can be seen, the live data screen shows the same parameter list, but this time with live values displayed for each parameter.

Parameter names are displayed with their full default text, or, if any parameter has been re-named, as in parameter 7 (Purge), above, then the new name appears here.

See 'Selected Parameter' for details of how to re-name the parameter.

SINGLE LOOP STYLE

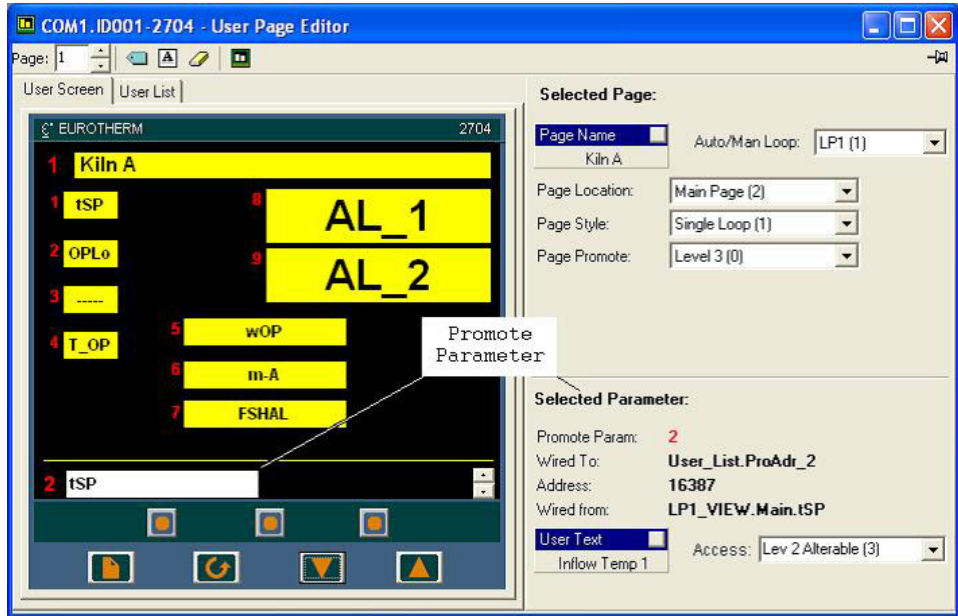

This provides a view of a single loop program. Parameters can be dragged to the relevant positions on the page, or they can be inserted using the Edit wiring tool button or 'Pages' menu item or by using the shortcut <Ctrl> + <E>.

The figure above shows Single Loop style, in edit mode. The live data screen is described below.

As can be seen above, the display screen is divided into a number of areas. Each of these areas is covered by a separate topic:

1. The user screen itself which shows a Model 2704 faceplate. Parameters can be dragged into the display from any other area of iTools.

The Control buttons (below) can be used to navigate through the pages and the page items. The 'Go to Menu' button calls the main menu, from which any one of the eight User Pages can be selected for view, either by double clicking on the menu item, or by clicking on the 'Select Page' control button.

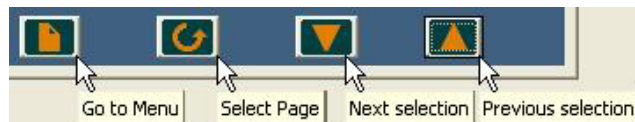

2. Selected Page area. This allows the currently selected page to be configured. See Selected Page for more details.
3. Selected Parameter area. This gives details of the currently selected parameter. See Selected Parameter for more details.

4. User pages toolbar . See 'Pages Toolbar' for further details.
5. User List Tab. See 'User List Tab' for further details.
6. Promote parameter. See 'Promote Parameters' for details.

LIVE DATA SCREEN

The live data screen shows how the single loop user screen appears on the instrument.



As can be seen, the live data screen is similar to the Edit screen, but this time with live values displayed for each parameter.

Default Parameter names are displayed or, if any parameter has been re-named, then the new name appears here.

See 'Selected Parameter' for details of how to re-name the parameter.

STATUS GRID

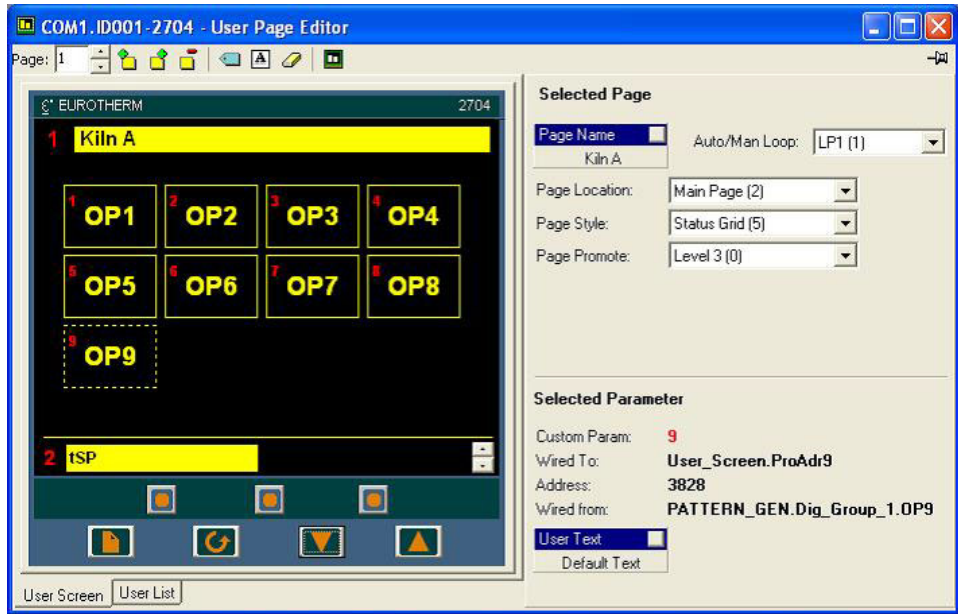

This provides a view of a status grid style, used to display the on/off status of digital values. Parameters can be dragged to the relevant positions on the page, or they can be inserted using the Edit wiring tool button or 'Pages' menu item or by using the shortcut <Ctrl> + <E>.

A maximum of 12 items can be shown. Parameters can be added (up to a maximum of 12) or deleted, using the toolbar tools, or the relevant selections from the Pages menu or by dragging.

The figure above shows the style, in edit mode. The live data screen is described below.

As can be seen above, the display screen is divided into a number of areas. Each of these areas is covered by a separate topic:

1. The user screen itself which shows a Model 2704 faceplate with space for up to 12 parameters'. Parameters can be dragged into the display from any other area of iTools.

The Control buttons (below) can be used to navigate through the pages and the page items. The 'Go to Menu' button calls the main menu, from which any one of the eight User Pages can be selected for view, either by double clicking on the menu item, or by clicking on the 'Select Page' control button.

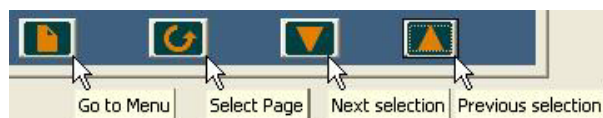

2. Selected Page area. This allows the currently selected page to be configured. See Selected Page for more details.
3. Selected Parameter area. This gives details of the currently selected parameter. See Selected Parameter for more details.
4. User pages toolbar . See 'Pages Toolbar' for further details.
5. User List Tab. See 'User List Tab' for further details.
6. Promote parameter. See 'Promote Parameters' for details.

LIVE DATA SCREEN

The live data screen shows how the status grid user screen appears on the instrument.

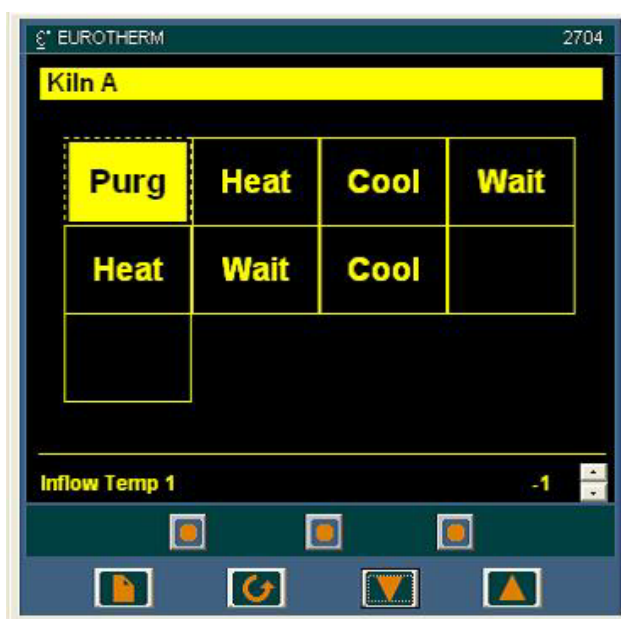

As can be seen, the live data screen is similar to the Edit screen, but 'On' (non-zero) parameters are highlighted yellow, and 'Off' (zero) parameters remain in black.

Text strings appear only for parameters that have been re-named, otherwise, the areas are blank.

See 'Selected Parameter' for details of how to re-name the parameter.

TRIPLE LOOP STYLE 1

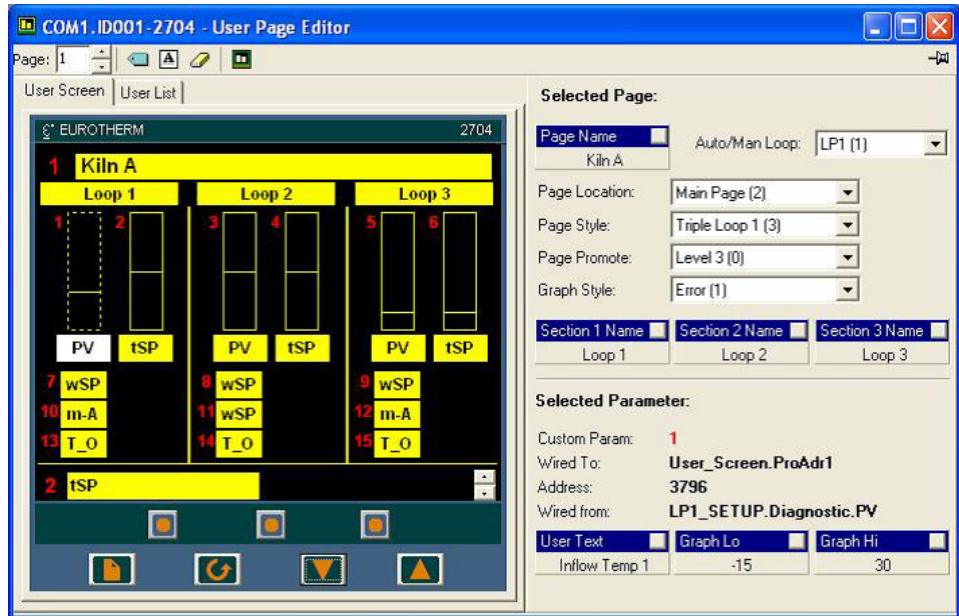

This provides a view of a triple loop style 1 program. Parameters can be dragged to the relevant positions on the page, or they can be inserted using the Edit wiring tool button or 'Pages' menu item or by using the shortcut <Ctrl> + <E>.

The figure above shows the style, in edit mode. The live data screen is described below.

As can be seen above, the display screen is divided into a number of areas. Each of these areas is covered by a separate topic:

1. The user screen itself which shows a Model 2704 faceplate. Parameters can be dragged into the display from any other area of iTools.

The Control buttons (below) can be used to navigate through the pages and the page items. The 'Go to Menu' button calls the main menu, from which any one of the eight User Pages can be selected for view, either by double clicking on the menu item, or by clicking on the 'Select Page' control button.

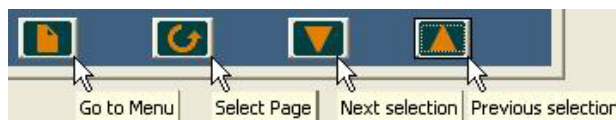

2. Selected Page area. This allows the currently selected page to be configured. See Selected Page for more details.
3. Selected Parameter area. This gives details of the currently selected parameter. See Selected Parameter for more details.

4. User pages toolbar . See 'Pages Toolbar' for further details.
5. User List Tab. See 'User List Tab' for further details.
6. Promote parameter. See 'Promote Parameters' for details.

LIVE DATA SCREEN

The live data screen shows how the triple loop user screen appears on the instrument.

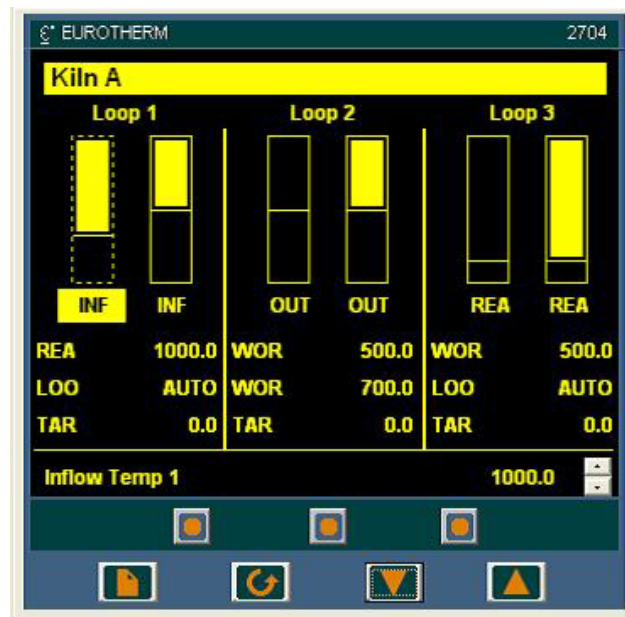

As can be seen, the live data screen is similar to the Edit screen, but this time with instantaneous values displayed for each parameter.

Default Parameter names are displayed or, if any parameter has been re-named, then the new name appears here.

See 'Selected Parameter' for details of how to re-name the parameter.

TRIPLE LOOP STYLE 2

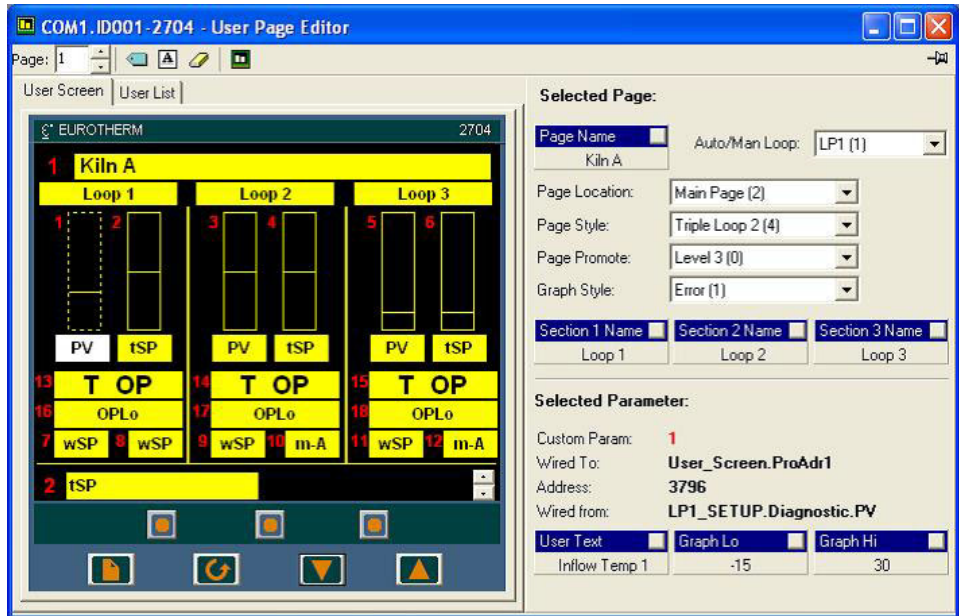

This provides a view of a triple loop style 2 program. Parameters can be dragged to the relevant positions on the page, or they can be inserted using the Edit wiring tool button or 'Pages' menu item or by using the shortcut <Ctrl> + <E>.

The figure above shows the style, in edit mode. The live data screen is described below.

As can be seen above, the display screen is divided into a number of areas. Each of these areas is covered by a separate topic:

1. The user screen itself which shows a Model 2704 faceplate. Parameters can be dragged into the display from any other area of iTools.

The Control buttons (below) can be used to navigate through the pages and the page items. The 'Go to Menu' button calls the main menu, from which any one of the eight User Pages can be selected for view, either by double clicking on the menu item, or by clicking on the 'Select Page' control button.

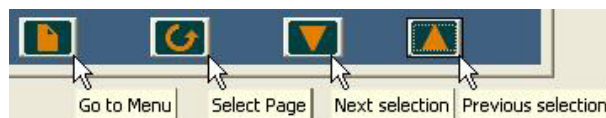

2. Selected Page area. This allows the currently selected page to be configured. See Selected Page for more details.
3. Selected Parameter area. This gives details of the currently selected parameter. See Selected Parameter for more details.

4. User pages toolbar . See 'Pages Toolbar' for further details.
5. User List Tab. See 'User List Tab' for further details.
6. Promote parameter. See 'Promote Parameters' for details.

LIVE DATA SCREEN

The live data screen shows how the triple loop style 2 user screen appears on the instrument.

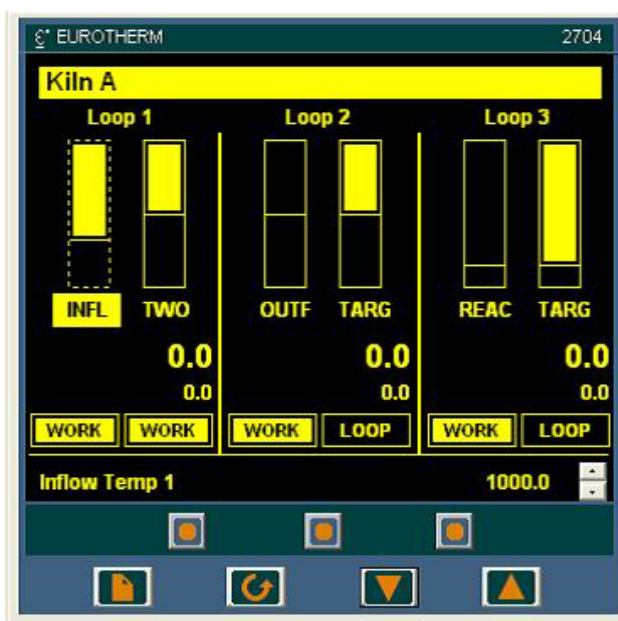

As can be seen, the live data screen is similar to the Edit screen, but this time with instantaneous values displayed for each parameter.

Default Parameter names are displayed or, if any parameter has been re-named, then the new name appears here.

See 'Selected Parameter' for details of how to re-name the parameter.

Promotion Parameters

The User List tab contains up to 10 parameters, which may be the same as or different from the parameters at the display. These parameters are called Promotion parameters.

One of these parameters is displayed at the bottom of the device screen, as shown above. The up/down arrows allow the user to scroll through the promotion parameters, one at a time, as required.

Go to Menu Control Button

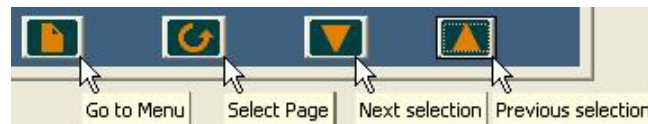

When the User Pages Editor is the active editor, the Go to Menu control button calls the top level User.

Pages menu, depicted below.

Any of the eight pages can be selected:

1. by double clicking on the relevant page item
2. by clicking on the item once, to highlight it, and then clicking on the 'Select Page' control button
3. by clicking on the item once, to highlight it, and then clicking on the 'Select Page' tool button

Note: Once a menu item has been selected, other items can be selected by use of the up/down (Next Selection/Previous selection) control buttons.

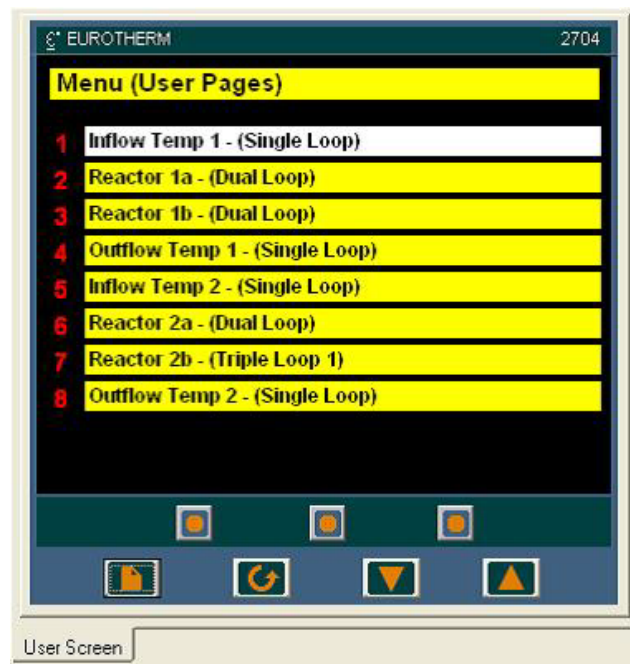

Appendix A Order Code

Hardware Code

The 2704 has a modular hardware construction, which accepts up to six plug-in modules and two digital communications modules. Eight digital IO and a relay form part of the fixed hardware build.

1	2	3	4	5	6	7	8	9	10	11	12	13	14	15	16	17	18			
1 Controller Type				5 - 9 I/O Slots 1 3 4 5 6						10 Memory Module			16 Toolkit Blocks							
2704 Standard 2704 Profibus f				XX None Fitted R4 Change Over Relay R2 2 Pin Relay RR Dual Relay T2 Triac TT Dual Triac D4 DC Control D6 DC Retransmission PV PV Input (slots 3 & 6) TL Triple Logic Input TK Triple Contact Input TP Triple Logic Output MS 24Vdc Transmitter PSU VU Potentiometer Input G3 5Vdc transducer PSU G5 10Vdc transducer PSU AM Analogue input (not in slot 5) DP Dual DC (porbe) input (slots 3 & 6) (4) LO Isolated single logic OP DO Dual 4-20mA OP/24Vdc PSU (5) (slots 1, 4, 5) HR Hi resolution DC retrans & 24Vdc PSU (slots 1, 4, 5) (6) TD TDS input (7) PH 4 wire PT100 (slots 3,6) PL 4 wire PT25 (slots 3,6)						XX Not Fitted MM Fitted			11 - Comms H XX None Fitted A2 232 Modbus Y2 2 wire EIA-485 F2 4 wire EIA-485 AE 232 Bisynch YE 2 Wire 485 Bisynch FE 4 Wire 485 Bisynch PB Profibus DN DeviceNet ET Modbus TCP/Ethernet (7)				XX Standard U1 16 An & 16 Dig U2 24 An & 32 Dig			
2 Supply Voltage													17 Tech Support							
VH Standard VL Profibus													TS1 1 Hour (default) TS0 None TS2 2 Hours TS4 4 Hours TS8 8 Hours							
3 Loops/Programs													18 Config Tools							
First Digit 1__ One Loop 2__ Two Loop 3__ Three Loop Second Digit _XX No Programs _2 20 Programs (1) _5 50 Programs _A Async Programs Third Digit _XX No Programs __1 1 Profile __2 2 Profile __3 3 Profile													XX None							
4 Application										12 Comms J										
XX Standard ZC Zirconia V1 1 Gauge Vacuum V3 3 Gauge Vacuum BC Boiler Function										XX None Fitted A2 232 Modbus Y2 2 wire EIA-485 F2 4 wire EIA-485 M1 232 Master M2 2-wire 485 Master M3 4-wire 485 Master										
										13 Manual										
										ENG English FRA French GER German NED Dutch SPA Spain SWE Sweden ITA Italian										

Hardware notes:

1. Basic controller includes 8 digital registers, 10 User Values, 4 timers, 4 totaliser and RT Clock
2. Toolkit 1 includes 16 analogue, 16 digital, pattern generator, digital programmer, analogue switch, wiring block & 30 user values
3. Toolkit 2 includes Toolkit 1 plus extra 16 analogue, 16 digital operations and 20 user values
4. Dual analogue input suitable for carbon probes.(inputs not isolated from each other)
5. Each channel of the DO module can be 4-20mA control or 24V PSU
6. The HR module has one high resolution DC output and one 24Vdc power supply
7. ET module in H slot includes terminal adaptor

Hardware Code Example

2704/VH/323/XX/RR/PV/D4/TP/PV/XX/A2/XX/ENG/U1/IT

Three loop controller with capability to store 20 three profile programs. Supply voltage 100 - 240 Vac.

Modules: 2 x PV input, 1 x Dual relay, 1 x DC control, 1 x Triple logic output, EIA-232 Comms,16 analogue and 32 digital operations.

General Notes

1. Loop 1 PV defaults to main input on microboard. Loop 2 and 3 PV inputs must be fitted in I/O slots 3 or 6 or be assigned to the analogue input.
2. This alarm configuration refers to loop alarms only. One selection per loop is allowed. Additional alarms are available for the user to configure.
3. Thermocouple and RTD inputs assume sensor min and max values with no decimal point.
4. Linear inputs are ranged 0-100%, no decimal point.
5. Temperature inputs will be C unless ordered by USA where F will be supplied.
6. Remote setpoints assume loop min & max ranges.
7. VP1, VP2, VP3 or VP4 not available with override function.
8. For cascade and override inputs only.
9. HR module should be used in feedback mode.

Quick Start Code

An instrument delivered to the quick start code is partly configured. For simple applications the quick start code may be sufficient to allow the instrument to be used without further configuration.

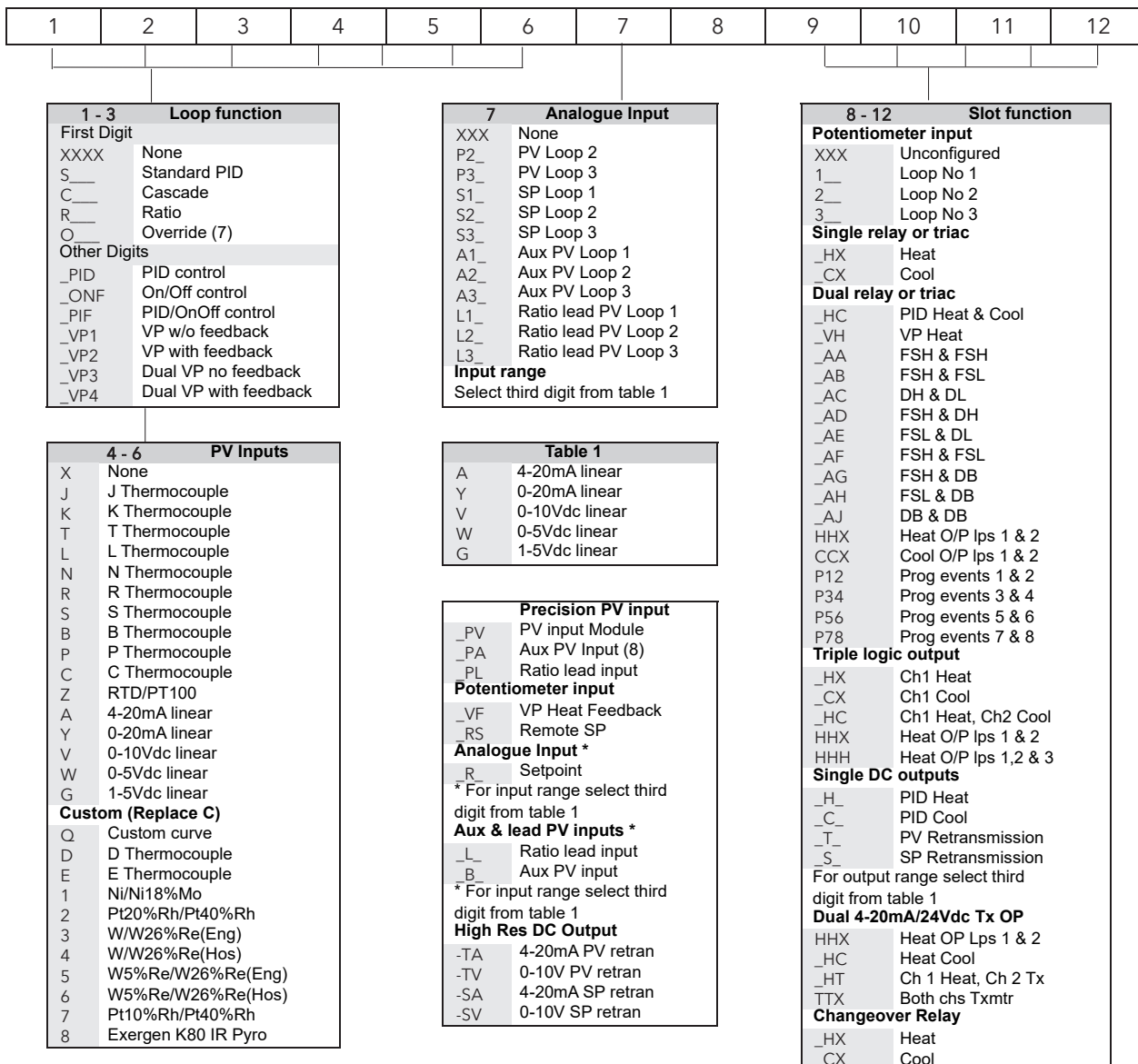

Quick Start Code Example:

SVP1/SPID/SPID/K/Z/A/S1A/1VH/2PV/2HV/3HC/3PV

This code configures the hardware specified in section Programmer Editor to be:

Loop1: Valve position control, Type K input, Ch1 VP output in slot 1, 4-20mA remote setpoint input.

Loop 2: PID control, RTD input in slot 3, 0-10Vdc Ch1 output in slot 4.

Loop 3: PID control, 4-20mA input in slot 6, Logic Ch1/Ch2 output in slot 5.

Appendix B Safety And EMC Information

This controller is manufactured in the UK by Eurotherm Controls Ltd.

Please read this section carefully before installing the controller

This controller is intended for industrial temperature and process control applications when it will meet the requirements of the European Directives on Safety and EMC. Use in other applications, or failure to observe the installation instructions of this handbook may impair the safety or EMC protection provided by the controller. It is the responsibility of the installer to ensure the safety and EMC of any particular installation.

Safety

This controller complies with the European Low Voltage Directive 2006/95/EC, by the application of the safety standard EN 61010.

Electromagnetic Compatibility

This controller conforms with the essential protection requirements of the EMC Directive 2004/108/EC, by the application of a Technical Construction File.

This instrument satisfies the general requirements for heavy/light industrial and residential/commercial environments as described by EN 61326. For more information on product compliance refer to the Technical Construction File.

General

The information contained in this manual is subject to change without notice. While every effort has been made to ensure the accuracy of the information, your supplier shall not be held liable for errors contained herein.

Unpacking and storage

The packaging should contain an instrument mounted in its sleeve, two mounting brackets for panel installation and an Installation & Operating guide. Certain ranges are supplied with an input adapter.

If on receipt, the packaging or the instrument are damaged, do not install the product but contact your supplier. If the instrument is to be stored before use, protect from humidity and dust in an ambient temperature range of -30°C to +75°C.

Service and Repair

This controller has no user serviceable parts. Contact your supplier for repair.

Caution: Charged capacitors

Before removing an instrument from its sleeve, disconnect the supply and wait at least two minutes to allow capacitors to discharge. It may be convenient to partially withdraw the instrument from the sleeve, then pause before completing the removal. In any case, avoid touching the exposed electronics of an instrument when withdrawing it from the sleeve.

Failure to observe these precautions may cause damage to components of the instrument or some discomfort to the user.

Electrostatic Discharge Precautions

When the controller is removed from its sleeve, some of the exposed electronic components are vulnerable to damage by electrostatic discharge from someone handling the controller. To avoid this, before handling the unplugged controller discharge yourself to ground.

Cleaning

Do not use water or water based products to clean labels or they will become illegible. Isopropyl alcohol may be used to clean labels. A mild soap solution may be used to clean other exterior surfaces of the product.

Installation Safety Requirements

Safety Symbols

Various symbols are used on the instrument, they have the following meaning:



Caution, (refer to the accompanying documents)



Functional earth (ground) terminal



This symbol indicates general information.



This symbol indicates a helpful hint.

The functional earth connection is not required for safety purposes but to ground RFI filters.

Personnel

Installation must only be carried out by suitably qualified personnel.

Enclosure of Live Parts

To prevent hands or metal tools touching parts that may be electrically live, the controller must be installed in an enclosure.

Isolation

The fixed digital I/O and analogue input are not isolated. The PV Input and all plug in modules are fully isolated.

The Analogue Input is a self biased differential input suitable for either grounded or floating transducers of low output impedance generating signal in the range of +/-10V or +/-20mA (with a burden resistor of 100 Ohms across + and - terminals).

This input is neither isolated from the instrument ground (which can be earthed via fixed I/O ports) nor isolated from the instrument earth terminal, therefore, under no circumstances should mains potentials be applied to any of its inputs.

In order for the Input to operate safely the common voltage at the inputs measured with respect to instrument ground should not exceed +/-120Vdc or acrms. For actively enhanced common mode rejection (i.e. operation within the spec.) this voltage should be limited to +/- 40Vdc.

Floating transducers will automatically be biased to +2.5V with respect to instrument ground upon connection.

Note: All the other I/Os are fully isolated from the instrument ground and each other.

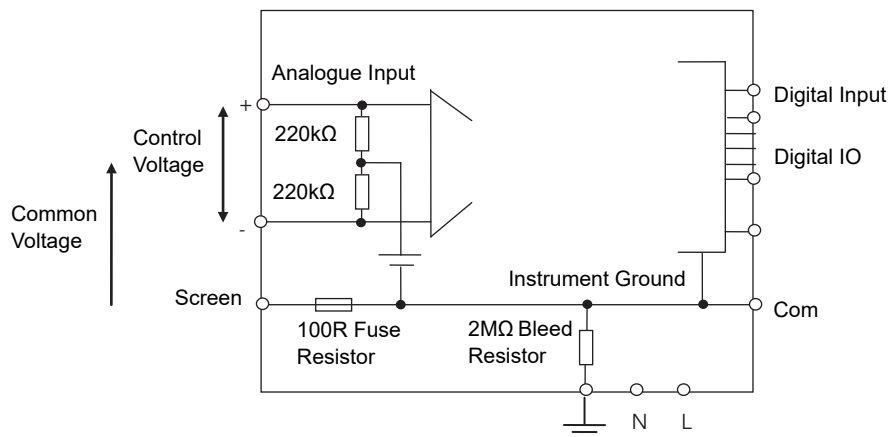

Figure 143 Analogue Input and Fixed Digital I/O Equivalent Circuit

Wiring

It is important to connect the controller in accordance with the wiring data given in this handbook. Take particular care not to connect AC supplies to the low voltage sensor input or other low level inputs and outputs. Only use copper conductors for connections (except thermocouple inputs) and ensure that the wiring of installations comply with all local wiring regulations. For example in the UK use the latest version of the IEE wiring regulations, (BS7671). In the USA use NEC Class 1 wiring methods.

Power Isolation

The installation must include a power isolating switch or circuit breaker. This device should be in close proximity to the controller, within easy reach of the operator and marked as the disconnecting device for the instrument.

Earth Leakage Current

Due to RFI Filtering there is an earth leakage current of less than 0.5mA. This may affect the design of an installation of multiple controllers protected by Residual Current Device, (RCD) or Ground Fault Detector, (GFD) type circuit breakers.

Overcurrent Protection

To protect the internal PCB tracking within the controller against excess currents, the AC power supply to the controller and power outputs must be wired through the fuse or circuit breaker specified in the technical specification.

Voltage Rating

The maximum continuous voltage applied between any of the following terminals must not exceed 264Vac:

- line or neutral to any other connection;
- relay or triac output to logic, dc or sensor connections;
- any connection to ground.

The controller should not be wired to a three phase supply with an unearthed star connection. Under fault conditions such a supply could rise above 264Vac with respect to ground and the product would not be safe.

Voltage transients across the power supply connections, and between the power supply and ground, must not exceed 2.5kV. Where occasional voltage transients over 2.5kV are expected or measured, the power installation to both the instrument supply and load circuits should include a transient limiting device.

These units will typically include gas discharge tubes and metal oxide varistors that limit and control voltage transients on the supply line due to lightning strikes or inductive load switching. Devices are available in a range of energy ratings and should be selected to suit conditions at the installation.

Conductive Pollution

Electrically conductive pollution must be excluded from the cabinet in which the controller is mounted. For example, carbon dust is a form of electrically conductive pollution. To secure a suitable atmosphere in conditions of conductive pollution, fit an air filter to the air intake of the cabinet. Where condensation is likely, for example at low temperatures, include a thermostatically controlled heater in the cabinet.

Over-Temperature Protection

When designing any control system it is essential to consider what will happen if any part of the system should fail. In temperature control applications the primary danger is that the heating will remain constantly on. Apart from spoiling the product, this could damage any process machinery being controlled, or even cause a fire.

Reasons why the heating might remain constantly on include:

- the temperature sensor becoming detached from the process;
- thermocouple wiring becoming short circuit;
- the controller failing with its heating output constantly on;
- an external valve or contactor sticking in the heating condition;
- the controller setpoint set too high.

Where damage or injury is possible, we recommend fitting a separate over-temperature protection unit, with an independent temperature sensor, which will isolate the heating circuit.

Please note that the alarm relays within the controller will not give protection under all failure conditions.

Grounding of the Temperature Sensor Shield

In some installations it is common practice to replace the temperature sensor while the controller is still powered up. Under these conditions, as additional protection against electric shock, we recommend that the shield of the temperature sensor is grounded. Do not rely on grounding through the framework of the machine.

Installation Requirements For EMC

To ensure compliance with the European EMC directive certain installation precautions are necessary as follows:

- For general guidance refer to EMC Installation Guide, HA025464.
- When using relay or triac outputs it may be necessary to fit a filter suitable for suppressing the emissions. The filter requirements will depend on the type of load.

Routing of Wires

To minimise the pick-up of electrical noise, the wiring for low voltage dc and particularly the sensor input wiring should be routed away from high-current power cables. Where it is impractical to do this, use shielded cables with the shield grounded at both ends. In general keep cable lengths to a minimum.

Appendix C Technical Specification

All figures quoted at 0 to 50°C unless otherwise stated.

All Analogue, Dual And Pv Inputs

Sample rate	9Hz (110msec.)
Input filtering	OFF to 999.9 seconds of filter time constant (f.t.c.). Default setting is 0.4 seconds unless stated otherwise
User calibration	Both the user calibration and a transducer scaling can be applied.
Sensor break	a.c. sensor break on each input (i.e. fast responding and no dc errors with high impedance sources).
Thermocouple types	Most linearisations including K,J,T,R,B,S,N,L,PlI,C,D,E with linearisation error < $\pm 0.2^{\circ}\text{C}$
General	Resolution (noise free) is quoted as a typical figure with f.t.c. set to the default value = 0.4 second. Resolution generally improves by a factor of two with every quadrupling of f.t.c. Calibration is quoted as offset error + percentage error of absolute reading at ambient temperature of 25°C Drift is quoted as extra offset and absolute reading errors per degree of ambient change from 25°C.

Precision PV Input / Module

Allocation	One standard and up to two additional PV input modules can be fitted in I/O slots 3 and 6
Isolation	Fully isolated from the rest of the instrument
mV input	Two ranges: $\pm 40\text{mV}$ & $\pm 80\text{mV}$, used for thermocouple, linear mV source or 0 - 20mA with 2.49 Ω Calibration: $\pm(1.5\mu\text{V} + 0.05\%$ of reading), Resolution: 0.5 μV for 40mV range & 1 μV for 80mV range Drift: $<\pm(0.05\mu\text{V} + 0.003\%$ of absolute reading) per °C Input impedance: >100M Ω , Leakage: < 1nA
0 - 2V input	-1.4V to +2V, used for zirconia Calibration: $\pm(0.5\text{mV} + 0.05\%$ of reading) Resolution: 60 μV Drift: $<\pm(0.05\text{mV} + 0.003\%$ of reading) per °C Input impedance: >100M Ω , Leakage: < 1nA
0 - 10V input	-3V to +10V, used for voltage input Calibration: $\pm(0.5\text{mV} + 0.1\%$ of reading) Resolution: 180 μV Drift: $<\pm(0.1\text{mV} + 0.01\%$ of reading) per °C Input impedance: 0.66M Ω
Pt100 input	0 to 400ohms (-200°C to +850°C), 3 matched wires - up to 22 Ω in each lead without errors. Calibration: $\pm(0.1^{\circ}\text{C} + 0.04\%$ of reading in °C) Resolution: 0.02°C Drift: $<\pm(0.006^{\circ}\text{C} + 0.002\%$ of absolute reading in °C) per °C Bulb current: 0.2mA.
Thermocouple	Internal compensation: CJC rejection ratio >40:1 typical. CJ Temperature calibration error at 25°C: $<\pm 0.5^{\circ}\text{C}$ 0°C, 45°C and 50°C external compensation available.
Zirconia probes	Most probes supported. Continuous monitoring of probe impedance (100 Ω to 100K Ω)

Dual (Probe) Input Module

General	The same specification as for the Precision PV Input module applies with the exception of the following: Module offers two sensor/transmitter inputs, which share the same negative input terminal. One low level (mV, 0-20mA, thermocouple, Pt100) and one high level (0-2Vdc, 0-10Vdc) can be connected
Isolation	The two inputs are isolated from the rest of the instrument but not from each other
Sample rate	4.5Hz (220msec) - of each input
Input filtering	Default setting is 0.8 seconds

Analogue Input

No of inputs	One fixed (Not isolated) Can be used with either floating or ground referenced transducers of low impedance – see Isolation.
Input range	-10V to +10V linear or 0 -20 mA with burden resistor of 100Ω. Calibration: $\pm(1.5\text{mV} + 0.1\% \text{ of reading})$ Resolution: 0.9mV Drift: $< \pm(0.1\text{mV} + 0.006\% \text{ of reading}) \text{ per } ^\circ\text{C}$ Input Impedance: 0.46MΩ (floating input), 0.23MΩ (ground referenced input)
Isolation	Not isolated from standard digital I/O. Differential type input with common mode range of $\pm 42\text{Vdc}$ (the average voltage of the two inputs with respect to 'Screen' or 'Common' terminals should be within $\pm 42\text{Vdc}$. CMRR: $>110\text{dB}$ at 50/60Hz, $>80\text{dB}$ at DC
Functions	Process variable, remote setpoint, power limit, feedforward, etc.

Analogue Input Module

Allocation	Up to 4 analogue input modules can be fitted in I/O slots 1,3,4 & 6
Isolation	Fully isolated from the rest of the instrument
mV input	100mV range - used for thermocouple, linear mV source, or 0-20mA with 2.49Ω external burden resistor. Calibration: $\pm 10\mu\text{V} + 0.2\% \text{ of reading}$ Resolution: 6μV Drift: $< \pm 0.2\mu\text{V} + 0.004\% \text{ of reading per } ^\circ\text{C}$ Input impedance: $>10\text{M}\Omega$, Leakage: $<10\text{nA}$
0 - 2Vdc input	-0.2V to +2.0V range - used for zirconia. Calibration: $\pm 2\text{mV} + 0.2\% \text{ of reading}$ Resolution: 30μV Drift: $< \pm 0.1\text{mV} + 0.004\% \text{ of reading per } ^\circ\text{C}$ Input impedance: $>10\text{M}\Omega$, Leakage: $<20\text{nA}$
0 - 10Vdc input	-3V to +10.0V range - used for voltage input. Calibration: $\pm 2\text{mV} + 0.2\% \text{ of reading}$ Resolution: 200μV Drift: $< \pm 0.1\text{mV} + 0.02\% \text{ of reading per } ^\circ\text{C}$ Input impedance: $>69\text{K}\Omega$
Pt100 input	0 to 400ohms (-200°C to +850°C), 3 matched wires - up to 22Ω in each lead without errors. Calibration: $\pm(0.4^\circ\text{C} + 0.15\% \text{ of reading in } ^\circ\text{C})$ Resolution: 0.08°C Drift: $< \pm(0.015^\circ\text{C} + 0.005\% \text{ of reading in } ^\circ\text{C}) \text{ per } ^\circ\text{C}$ Bulb current: 0.3mA.

Thermocouple	Internal compensation: CJC rejection ratio >25:1 typical. CJ Temperature calibration error at 25°C: $\leq \pm 2^\circ\text{C}$ 0°C, 45°C and 50°C external compensation available.
Allocation	Up to 4 analogue input modules can be fitted in I/O slots 1,3,4 & 6

Standard Digital I/O

Allocation not isolated	1 digital input standard and 7 I/O which can be configured as inputs or outputs plus 1 changeover relay
Digital inputs	Voltage level: input active < 2Vdc, inactive >4Vdc Contact closure: input active <100ohms, inactive >28kohms
Digital outputs	Open collector, 24Vdc at 40mA drive capability, requires external supply
Changeover relay	Contact rating 2A at 264Vac resistive
Functions	Refer to Standard IO

Digital Input Modules

Module type	Triple contact input, Triple logic input - (isolated as a group)
Allocation	Can be fitted into slots 1, 3, 4, 5 or 6
Contact closure	Active <100ohms, inactive >28kohms
Logic inputs	Current sinking: active 10.8Vdc to 30Vdc at 2.5mA inactive -3 to 5Vdc at <-0.4mA
Functions	Refer to Module IO

Digital Output Modules

Module types	Single relay, dual relay, single triac, dual triac - (isolated as a group) (individually isolated) triple logic module - (isolated from instrument as a group)
Allocation	Can be fitted into slot 1, 3, 4, 5 or 6 (max. 3 triac modules per instrument)
Relay rating	2A, 264Vac resistive
Logic drive	12Vdc at 9mA
Triac rating	0.75A, 264Vac resistive
Functions	Refer to Module IO

Analogue Output Modules

Module types	1 channel DC control, 1 channel DC retransmission (5 max.)
Allocation	Can be fitted into slot 1, 3, 4, 5 or 6
Isolation	Fully isolated from the rest of the instrument
Range	0-20mA, 0-10Vdc
Resolution	1 part in 10,000 (2,000-noise free) 0.5% accurate for retransmission 1 part in 10,000 2.5% accurate for control
Functions	Refer to Module IO

Transmitter PSU

Allocation	Can be fitted into slots 1, 3, 4, 5 or 6 - (isolated)
Transmitter	24Vdc at 20mA

Transducer PSU

Bridge voltage	Software selectable 5 or 10Vdc - (isolated)
Bridge resistance	300 Ω to 15K Ω
Internal shunt resistor	30.1K Ω at 0.25%, used for calibration of 350 Ω bridge

Dual DC Output

Two Current Outputs Isolation	4-20mA, 20V output span (see section Dual DC Output) Fully isolated from the instrument and each other
Accuracy	1%, 11 bit noise free resolution
Speed	50ms response
Can be configured as Transmitter/logic PSU	20V min at full 22mA current load. 30V max at open circuit. Short circuit protected at 22-24mA

High Resolution DC Output

Current Output	4-20mA, 20V output span (see section High Resolution Retransmission Output)
Accuracy	1%, 15 bit noise free resolution
Speed	40ms response
Transmitter/logic PSU	20V min at full 22mA current load. 30V max at open circuit. Short circuit protected at 21-28mA
Isolation	Fully isolated from the instrument and the PSU

Potentiometer Input

Pot resistance	100 Ω to 15K Ω , excitation of 0.5 volts - (isolated)
----------------	---

TDS Module

Meas. Frequency	1KHz
Conductivity range	40 μ S to 500 000 μ S (equivalent resistance 25 K Ω to 2 Ω)
Max. cable length	100m
Isolation	Fully isolated from the rest of the instrument

4-Wire RTD Input

	PT100 Module	PT25 Module
Allocation	Can be fitted to I/O slots 3 and 6	
Isolation	Fully isolated from the rest of the instrument	
Sample rate	9Hz Typical	
Input filtering	OFF to 999.9 seconds of filter t.c. (default f.t.c. = 1.6 sec.)	
Measured temperature range	-200 to +850°C with Pt100 linearization	-200 to +850°C with Pt25.5 linearization -200 to +50°C with Pt100 linearization when Pt25 module is used for reading Pt100 sensor.
Measured resistance range	0 - 440Ω	0 – 125Ω
Maximum resistance between A and D terminals	500Ω	135Ω
Bulb Current - from A to D	200μA	735μA
Calibration Accuracy @ 23 (±3) °C @ 50 (±15) %RH /interpolate for other values/	±4mΩ @ 20Ω ±8mΩ @ 100Ω ±10mΩ @ 200Ω ±14mΩ @ 300Ω	±1mΩ @ 5Ω ±2mΩ @ 25.5Ω ±2.5mΩ @ 50Ω ±3.5mΩ @ 76Ω
Ambient temperature drift (within 15°C and 35°C)	(5ppm of reading +0.25m) /°C	± (5ppm of reading +0.07mΩ) /°C
Long term drift @ 15°C to 35°C @ 50 (±20) %RH	± (70ppm of reading + 25ppm of Span)/year	
Resolution with: f.t.c. = OFF f.c.t. = 1.6 secs. f.t.c. = 10 secs.	/Resolution as peak deviation from mean value/ ± 6m (±16mK) ±1.5mΩ (±16mK, ±4mK*) ± 1.5mΩ (±4mK) ±0.4mΩ (±4mK, ±1mK*) ± 0.8mΩ (±2mK) ±0.2mΩ (±2mK, ±0.5mK*)	
Linearity within 0 to 80% of Span/	±2m Typ.	±0.6mΩ Typ.
Linearization Pt100 and Pt25.5/	±5mK - maximum deviation within -200°C to 850°C from the standard characteristic that assumes precise 100.000Ω and 25.500Ω PRT resistances at 0°C.	
Other Features	a.c. sensor break detection. User Calibration.	
Immunity to EM field interference (EN61326 Industrial levels)	Maximum deviation on measured values during the tests is within ±0.005% of Full Span.	

For description and remedies of other possible sources of error see section 4-Wire RTD Module Calibration.

Digital Communications

Allocation	2 modules fitted in slots H & J (isolated)
Modbus	RS232, 2 wire or 4 wire RS485, max baud 19.2KB in H module & 9.6KB in J module
Profibus-DP	High speed, RS485, 1.5Mbaud. H slot only
DeviceNet/ EtherNet	H slot only

Alarms

No of Alarms	Input alarms (2), loop alarms (2) User alarms (8)
Alarm types	Full scale, deviation, rate of change, sensor break plus application specific
Modes	Latching or non-latching, blocking, time delay
Parameters	Refer to Alarm Operation

User Messages

No of messages	Maximum 100, triggered by operator or alarm or used for custom parameter names
Format	Up to 16 characters

Control Functions

No of loops	One, two or three
Modes	On/off, PID, motorised valve with or without feedback
Options	Cascade, ratio, override or feed forward
Cooling algorithms	Linear, water, oil or fan
PID sets	3 per loop (Cascade loop includes master and slave parameters)
Manual mode	Bumpless transfer or forced manual output, manual tracking available
Setpoint rate limit	Display units per second, minute or hour

Setpoint Programmer

Programmer modes	Synchronous or asynchronous
Programmer types	Time to Target or Ramp Rate
No of programs	A maximum of 60 programs assignable over 600 segments for a time to target programmer and 480 segments for a ramp rate programmer. A program can consist of up to 3 variables. Programs can be given user defined 16 character names
Event outputs	Up to 16, can be assigned individually to segments or called as part of an event group

Advanced Functions

Application blocks	32 digital operations 32 patch wiring operators 32 analogue calculations 3 multiple operators
Timers	4, On Pulse, Off delay, one shot and min-On
Totalisers	4, trigger level & reset input
Real time clock	Day of week and time
Pattern generators	16 x 16, 2 off

General Specification

Display range	5 digits including up to 3 decimal places
High voltage supply	100 to 230Vac \pm 15%, 20Watts (max)
Low voltage supply	24Vac -15%, +10% 24Vdc -15%, +20%
Operating ambient	0 - 50°C and 5 to 95% RH non condensing
Storage temp	-10 to +70°C
Panel sealing	IP65
Dimensions	96H x 96W x 150D (mm)
EMC standards	EN61326 electrical equipment for measurement, control and laboratory use EMS requirements - suitable for, commercial and light industrial as well as heavy industrial environments With Ethernet module fitted product is suitable for heavy industrial environments only (class A emissions).
Safety standards	Meets EN61010 installation category II, pollution degree 2
Atmospheres	Not suitable for use above 2000m or in explosive or corrosive atmospheres
Inrush Current	High Voltage controller – 30A duration 100 μ s Low Voltage controller – 15A duration 100 μ s

Graphical Representation of Errors

This section shows graphically the effects of adding all contributions of different errors for each input type and range. The errors are a combination of:

Calibration accuracy, Drift with ambient temperature, Linearity error, Leakage

mV Input

Two ranges:

working range $\pm 40\text{mV}$
 full linear range $\pm 60\text{mV}$
 noise (resolution) $1\mu\text{V}$ - OFF, $0.5\mu\text{V}$ - 0.4sec, $0.25\mu\text{V}$ - 1.6sec

working range $\pm 80\text{mV}$
 full linear range $\pm 105\text{mV}$
 noise (resolution) $2\mu\text{V}$ - OFF, $1\mu\text{V}$ - 0.4sec, $0.5\mu\text{V}$ - 1.6sec

Calibration accuracy @ 25°C
 $< \pm (1.5\mu\text{V} + 0.05\% \text{ of } |\text{reading}|)$

Drift with ambient temperature
 $< \pm (0.05\mu\text{V} + 0.003\% \text{ of } |\text{reading}|) \text{ per } ^\circ\text{C}$

Linearity error

Linearity error
 $< \pm 0.002\% \text{ of span (i.e. } < 1\mu\text{V, } < 2\mu\text{V})$

Leakage

$< \pm 1\text{nA}$ (typically $\pm 200\text{pA}$)

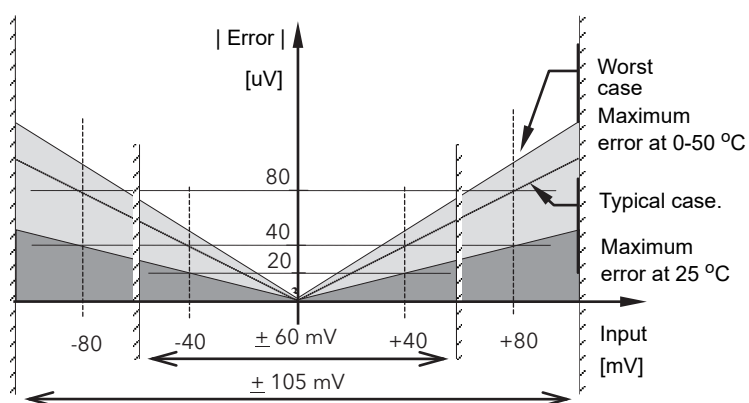

Figure 144 Error Graph - mV Input

Mid range high impedance Input

0 - 2V Input type

Range

working range	-1.4V to +2V
full linear range	-1.8V to +2.4V
noise (resolution)	100uV - OFF, 50uV - 0.4sec, 35uV - 1.6sec

Calibration accuracy @ 25°C

< + (0.5mV + 0.05% of |reading|)

Drift with ambient temperature

< +(0.05mV + 0.003% of |reading|) per °C

Linearity error

< + 0.01% of span (i.e. + 200uV)

Input Impedance & Leakage

>100MΩ < 1nA

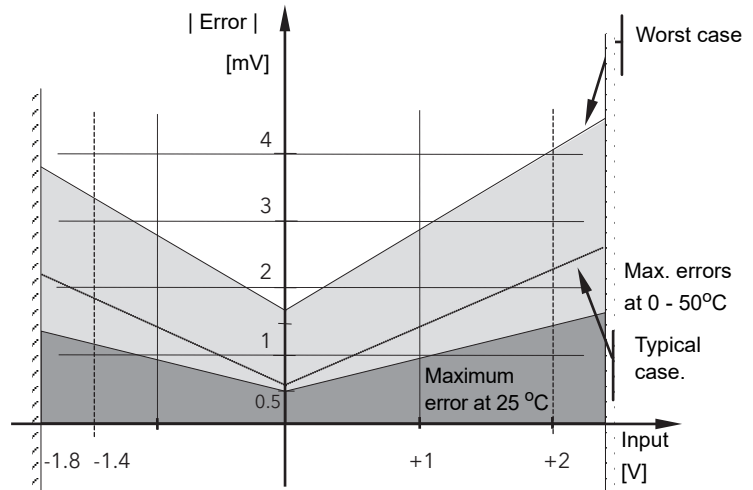

Figure 145 Error Graph - 0 - 2V Input

High Level Input

0 - 10V Input type

Range:

working range	-3V to +10V
full linear range	- 5V to +14V
noise (resolution)	300uV - OFF, 150uV - 0.4sec, 100uV - 1.6sec

Calibration accuracy @ 25°C

< + (0.5mV + 0.1% of |reading|)

Drift with ambient temperature

< +(0.01mV + 0.006% of |reading|) per °C

Linearity error

< +0.02% of span (i.e. + 2mV)

Input Impedance

0.66 MΩ

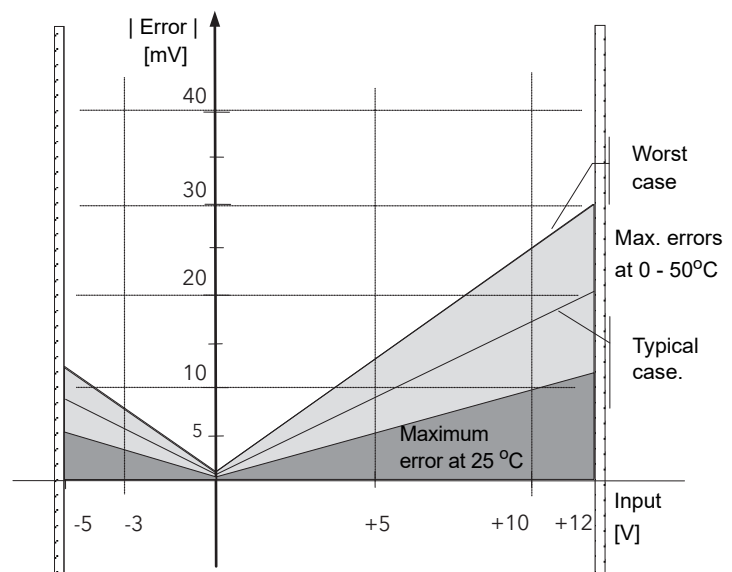

Figure 146 Error Graph - 0 - 10V Input

3-Wire RTD (Pt-100) Input type

Resistance measurement specification in Ohms:

Range

0 to 400Ω with up to 22Ω in each connecting lead

Noise (resolution)

8mΩ - 0.4sec, 4mΩ - 1.6sec

Calibration accuracy limits @ 25°C

< + (35mΩ @110Ω + 0.03% of |reading - 110Ω |)

Drift with ambient temperature

+ (0.002% of |reading|) per °C

Linearity error

< +15 mΩ

Pt-100 measurement specification in °C:

Range

-200 °C to +850 °C

Noise (resolution)

0.02 °C - 0.4sec, 0.01 °C - 1.6sec

Calibration accuracy limit @ 25°C

Drift with ambient temperature

< +(0.0055 °C + 0.002% of |reading in °C |) per °C of ambient change

Linearity + Linearisation error

< + (0.1 °C + 0.03% of |reading in °C |)

< + 55 °mC (i.e. 50 °mC + 5 °mC)

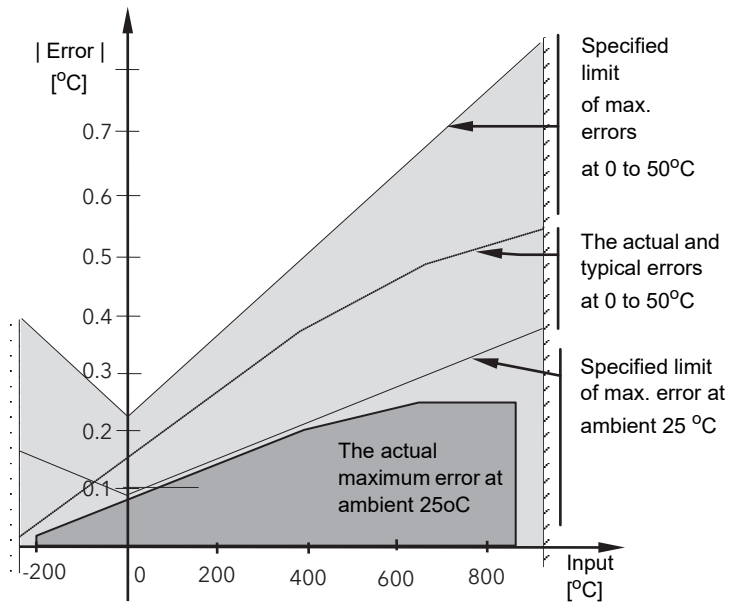

Figure 147 Error Graph - RTD Input

Thermocouple Input type

Internal CJT sensing spec

Calibration error @ 25 °C (including temp. difference between top and bottom screws)

<± 0.5 °C

Total CJT error

< ± (0.5 °C + 0.012 °C per 1 °C of ambient change)

(i.e. CJC Rejection for measured temperatures above 0 °C is > 80: 1)

Noise (resolution)

0.01 °C

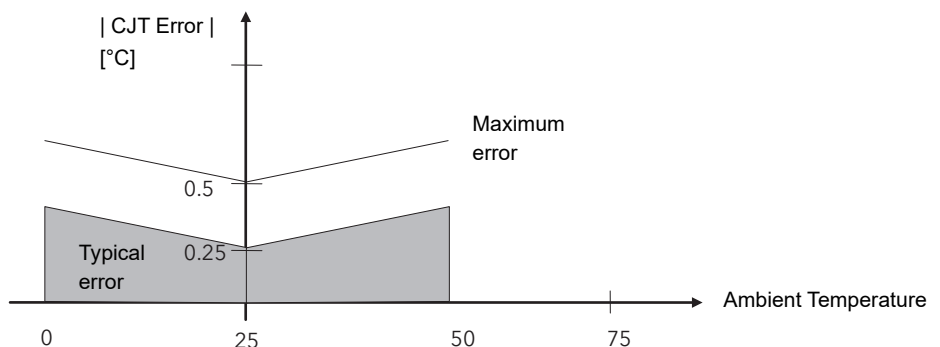

Figure 148 Overall CJT Error at Different Ambient Temperatures

Appendix D Parameter Units and Addresses

Commonly Used Parameters

Although any parameter can be chosen for Soft Wiring, Parameter Promotion or Customised Display purposes, the controller contains those which are most commonly used together with their Modbus Addresses. These parameters are shown below:

Parameter Name	Parameter Description	Refer To Section	Modbus Address
None	None		00000
L1.PV	Loop1 PV	Loop Set Up	00001
L1.Wkg OP	Loop1 working output	LP1 SETUP	00004
L1.Wkg SP	Loop1 working setpoint	Diagnostic Page	00005
L1.Ch1 OP	Loop1 channel 1 output	Output Page	00013
L1.Ch2 OP	Loop1 channel 2 output	Output Page	00014
L2.PV	Loop2 PV	Loop Set Up	01025
L2.Wkg OP	Loop2 working output	LP2 SETUP	01028
L2.Wkg SP	Loop2 working setpoint	Diagnostic Page	01029
L2.Ch1 OP	Loop2 channel 1 output	Output Page	01037
L2.Ch2 OP	Loop2 channel 2 output	Output Page	01038
L3.PV	Loop3 PV	Loop Set Up	02049
L3Wkg OP	Loop3 working output	LP3 SETUP	02052
L3Wkg SP	Loop3 working setpoint	Diagnostic Page	02053
L3Ch1 OP	Loop3 channel 1 output	Output Page	02061
L3Ch2 OP	Loop3 channel 2 output	Output Page	02062
CLin1.OP	Custom linearisation 1	Input Operators INPUT OPERS Cust Lin 1	03365
CLin2.OP	Custom linearisation 2	Cust Lin 2	03413
CLin3.OP	Custom linearisation 3	Cust Lin 3	03461
SwOv1.OP	Switchover output value	Switch 1 Page	03477
Mod1A.Val	Module 1A output value	Module IO Module 1A page	04148
Mod1B.Val	Module 1B output value	Module 1B page	04196
Mod1C.Val	Module 1C output value	Module 1C page	04244
Mod3A.Val	Module 3A output value	Module 3A page	04468
Mod3B.Val	Module 3B output value	Module 3B page	04516
Mod3C.Val	Module 3C output value	Module 3C page	04564
Mod4A.Val	Module 4A output value	Module 4A page	04628
Mod4B.Val	Module 4B output value	Module 4B page	04676
Mod4C.Val	Module 4C output value	Module 4C page	04724
Mod5A.Val	Module 5A output value	Module 5A page	04788
Mod5B.Val	Module 5B output value	Module 5B page	04836
Mod5C.Val	Module 5C output value	Module 5C page	04884
Mod6A.Val	Module 6A output value	Module 6A page	04948
Mod6B.Val	Module 6B output value	Module 6B page	04996
Mod6C.Val	Module 6C output value	Module 6C page	05044
PVIn.Val	PV input value	Standard IO PV Input page	05108
AnIn.Val	Analogue input value	An Input Page	05268
DIO1.Val	Digital input/output value 1	Dig IO1 Page	05402
DIO2.Val	Digital input/output value 2	Dig IO2 Page	05450
DIO3.Val	Digital input/output value 3	Dig IO3 Page	05498
DIO4.Val	Digital input/output value 4	Dig IO4 Page	05546

Parameter Name	Parameter Description	Refer To Section	Modbus Address	
DIO5.Val	Digital input/output value 5	Dig IO5 Page	05594	
DIO6.Val	Digital input/output value 6	Dig IO6 Page	05642	
DIO7.Val	Digital input/output value 7	Dig IO7 Page	05690	
Prg.PSP1	Programmer working SP1	Programmer Configuration RUN PSP1 Page	05800	
Prg.PSP2	Programmer working SP2	PSP2 Page	05801	
Prg.PSP3	Programmer working SP3	PSP3 Page	05802	
Prg.Uval1	Programmer user value 1	PROGRAM EDIT Segment Page	05808	
Prg.Uval2	Programmer user value 2		05809	
Prg.DO1	Programmer digital OP1	Programmer Configuration RUN General Page	05869	
Prg.DO2	Programmer digital OP2		05870	
Prg.DO3	Programmer digital OP3		05871	
Prg.DO4	Programmer digital OP4		05872	
Prg.DO5	Programmer digital OP5		05873	
Prg.DO6	Programmer digital OP6		05874	
Prg.DO7	Programmer digital OP7		05875	
Prg.DO8	Programmer digital OP8		05876	
ProgEnd	End of Program		05892	
ProgRun	Program run		05893	
ProgHold	Program hold		05894	
ProgNewSe	Program new segment		05895	
ProgReset	Program reset		05906	
AnOp1.OP	Analogue operator OP1		Analogue And Multiple Operators Analogue 1 Page	06158
AnOp2.OP	Analogue operator OP2		Analogue 2 Page	06178
AnOp3.OP	Analogue operator OP3	Analogue 3 Page	06198	
AnOp4.OP	Analogue operator OP4	Analogue 4 Page	06218	
AnOp5.OP	Analogue operator OP5	Analogue 5 Page	06238	
AnOp6.OP	Analogue operator OP6	Analogue 6 Page	06258	
AnOp7.OP	Analogue operator OP7	Analogue 7 Page	06278	
AnOp8.OP	Analogue operator OP8	Analogue 8 Page	06298	
AnOp9.OP	Analogue operator OP9	Analogue 9 Page	06318	
AnOp10.OP	Analogue operator OP10	Analogue 10 Page	06338	
AnOp11.OP	Analogue operator OP11	Analogue 11 Page	06358	
AnOp12.OP	Analogue operator OP12	Analogue 12 Page	06378	
AnOp13.OP	Analogue operator OP13	Analogue 13 Page	06398	
AnOp14.OP	Analogue operator OP14	Analogue 14 Page	06418	
AnOp15.OP	Analogue operator OP15	Analogue 15 Page	06438	
AnOp16.OP	Analogue operator OP16	Analogue 16 Page	06458	
LgOp1.OP	Logic operator output 1	Logic Operators Logic 1 Page	07176	
LgOp2.OP	Logic operator output 2	Logic 2 Page	07192	
LgOp3.OP	Logic operator output 3	Logic 3 Page	07208	
LgOp4.OP	Logic operator output 4	Logic 4 Page	07224	
LgOp5.OP	Logic operator output 5	Logic 5 Page	07240	
LgOp6.OP	Logic operator output 6	Logic 6 Page	07256	
LgOp7.OP	Logic operator output 7	Logic 7 Page	07272	
LgOp8.OP	Logic operator output 8	Logic 8 Page	07288	
LgOp9.OP	Logic operator output 9	Logic 9 Page	07304	
LgOp10.OP	Logic operator output 10	Logic 10 Page	07320	
LgOp11.OP	Logic operator output 11	Logic 11 Page	07336	
LgOp12.OP	Logic operator output 12	Logic 12 Page	07352	
LgOp13.OP	Logic operator output 13	Logic 13 Page	07368	

Parameter Name	Parameter Description	Refer To Section	Modbus Address
LgOp14.OP	Logic operator output 14	Logic 14 Page	07384
LgOp15.OP	Logic operator output 15	Logic 15 Page	07400
LgOp16.OP	Logic operator output 16	Logic 16 Page	07416
Clk.Alm1	Timer alarm 1	Timer, Clock, Totaliser, Operation TIMER BLOCKS Alarm 1 Page	08711
Clk.Alm2	Timer alarm 2	Alarm 2 Page	08716
Tot1.Alm	Totaliser 1 alarm output	Timer, Clock, Totaliser, Operation TIMER BLOCKS Totaliser 1 Page	08743
Tot2.Alm	Totaliser 2 alarm output	Totaliser 2 Page	08757
Tot3.Alm	Totaliser 3 alarm output	Totaliser 3 Page	08775
Tot4.Alm	Totaliser 4 alarm output	Totaliser 4 Page	08791
Tmr1.OP	Timer 1 output	Timer, Clock, Totaliser, Operation TIMER BLOCKS Timer 1 Page	08963
Tmr2.OP	Timer 2 output	Timer 2 Page	08975
Tmr3.OP	Timer 3 output	Timer 3 Page	08987
Tmr4.OP	Timer 4 output	Timer 4 Page	08999
UVal1.Val	User 1 value	User Values User Val 1 Page	09220
UVal2.Val	User 2 value	User Val 2 Page	09225
UVal3.Val	User 3 value	User Val 3 Page	09230
UVal4.Val	User 4 value	User Val 4 Page	09235
Pat1.OP1	Pattern 1 output 1	Pattern Generator Dig Group 1	09973
Pat1.OP2	Pattern 1 output 2		09974
Pat1.OP3	Pattern 1 output 3		09975
Pat1.OP4	Pattern 1 output 4		09976
Pat1.OP5	Pattern 1 output 5		09977
Pat1.OP6	Pattern 1 output 6		09978
Pat1.OP7	Pattern 1 output 7		09979
Pat1.OP8	Pattern 1 output 8		09980
Pat1.OP9	Pattern 1 output 9		09981
Pat1.OP10	Pattern 1 output 10		09982
Pat1.OP11	Pattern 1 output 11		09983
Pat1.OP12	Pattern 1 output 12		09984
Pat1.OP13	Pattern 1 output 13		09985
Pat1.OP14	Pattern 1 output 14		09986
Pat1.OP15	Pattern 1 output 15		09987
Pat1.OP16	Pattern 1 output 16		09988

Parameter Name	Parameter Description	Refer To Section	Modbus Address
Pat2.OP1	Pattern 2 output 1	Pattern Generator Dig Group 2	10037
Pat2.OP2	Pattern 2 output 2		10038
Pat2.OP3	Pattern 2 output 3		10039
Pat2.OP4	Pattern 2 output 4		10040
Pat2.OP5	Pattern 2 output 5		10041
Pat2.OP6	Pattern 2 output 6		10042
Pat2.OP7	Pattern 2 output 7		10043
Pat2.OP8	Pattern 2 output 8		10044
Pat2.OP9	Pattern 2 output 9		10045
Pat2.OP10	Pattern 2 output 10		10046
Pat2.OP11	Pattern 2 output 11		10047
Pat2.OP12	Pattern 2 output 12		10048
Pat2.OP13	Pattern 2 output 13		10049
Pat2.OP14	Pattern 2 output 14		10050
Pat2.OP15	Pattern 2 output 15		10051
Pat2.OP16	Pattern 2 output 16		10052
Sum.LP2&3	Summary of loop 2 and loop3		10246
Sum.PrName	Summary of programmer name	Programmer Configuration PROGRAM RUN General Page	10247
Sum.D1-16	Summary of digital outputs 1 to 16		10248
Sum.TiRem	Summary of program time remaining		10249
Const.1	Constant value = 1 May be used in place of a User Value		10464
Zirc.PV	Zirconia Value	Zirconia - Carbon Potential Control	11059
Zirc.Stat,	Probe Status	ZIRCONIA	11066
Zirc.Clea	Clean State	Options Page	11067
Zirc.SAlm	Sooting Alarm	PROBE	11068
Humid.%RH	Relative Humidity	Humidity Control HUMIDITY Options Page	11105
Humid.DwP	Dewpoint		11106
DI8.Val	Status of digital input 8	Standard IO Diagnostic Page	11313
DI-E1.Val	Status of IO expander inputs		11314
L1Alm1.OP	Loop1 alarm 1 output	Alarm Operation ALARMS LP1 Page	11592
L1Alm2.OP	Loop1 alarm 2 output	LP1 Page	11602
L2Alm1.OP	Loop2 alarm 1 output	LP2 Page	11640
L2Alm2.OP	Loop2 alarm 2 output	LP2 Page	11650
L3Alm1.OP	Loop3 alarm 1 output	LP3 Page	11688
L3Alm2.OP	Loop3 alarm 2 output	LP3 Page	11698
U1Alm.OP	User 1 alarm output	User 1 Page	11737
U2Alm.OP	User 2 alarm output	User 2 Page	11753
U3Alm.OP	User 3 alarm output	User 3 Page	11769
U4Alm.OP	User 4 alarm output	User 4 Page	11785
U5Alm.OP	User 5 alarm output	User 5 Page	11801
U6Alm.OP	User 6 alarm output	User 6 Page	11817
U7Alm.OP	User 7 alarm output	User 7 Page	11833
U8Alm.OP	User 8 alarm output	User 8 Page	11849
NewAlarm	New alarm	Summary Page	12162

Parameter Name	Parameter Description	Refer To Section	Modbus Address
IOEx.IP1	IO expander input 1		12187
IOEx.IP2	IO expander input 2		12188
IOEx.IP3	IO expander input 3		12189
IOEx.IP4	IO expander input 4		12190
IOEx.IP5	IO expander input 5		12191
IOEx.IP6	IO expander input 6		12192
IOEx.IP7	IO expander input 7		12193
IOEx.IP8	IO expander input 8		12194
IOEx.IP9	IO expander input 9		12195
IOEx.IP10	IO expander input 10		12196

Parameter Units

PSP Units are:

None

°C/°F/°K,

V, mV, A, mA,

PH, mmHg, psi, bar, mbar, %RH, %, mmWG, inWG, inWW, Ohms, PSIG, %O2, PPM, %CO2, %CP, %/sec,

°C\°F\°K(rel),

Custom 1, Custom 2, Custom 3, Custom 4, Custom 5, Custom 6,

sec, min, hrs,

Module Status Messages

OK	Module good
Initialising	Module initialising
Ch A SBreak	Channel A sensor input break
Ch C SBreak	Channel C sensor input break
Ch A Out Range	Channel A out of range
Ch C Out Range	Channel C out of range
Ch A IP Sat	Channel A input saturation
Ch C IP Sat	Channel C input saturation
Ch A Not Calib	Channel A not calibrated
Ch C Not Calib	Channel C not calibrated
Ch Short CCT	Channel terminals shorted



Scan for local contacts

Eurotherm Ltd

Faraday Close

Durrington

Worthing

West Sussex

BN13 3PL

Phone: +44 (0) 1903 268500

www.eurotherm.com

As standards, specifications, and designs change from time to time, please ask for confirmation of the information given in this publication.

© 2021 Eurotherm Limited. All Rights Reserved.

HA026933 Issue 10 CN39194