

# PM PLUS™

## PID/Integrated Controller

### User's Guide



PM6 PLUS



PM8 PLUS



PM9 PLUS



# WATLOW®

*Powered by Possibility*



1241 Bundy Boulevard., Winona, Minnesota USA 55987  
Phone: +1 (507) 454-5300, Fax: +1 (507) 452-4507  
<http://www.watlow.com>



---

# Introduction

## Warranty

PM PLUS power controllers are warranted by Watlow in accordance with the terms and conditions set forth on Watlow's website at [www.watlow.com/terms](http://www.watlow.com/terms).

## Technical Assistance



If you encounter a problem with your Watlow® controller, review your configuration information to verify that your selections are consistent with your application: inputs, outputs, alarms, limits, etc. If the problem persists, you can get technical assistance from your local Watlow representative by e-mailing your questions to [wintechsupport@watlow.com](mailto:wintechsupport@watlow.com) or by dialing +1 (507) 494-5656 between 7 a.m. and 5 p.m. Central Time USA & Canada. Ask for for an Applications Engineer. Please have the complete model number available when calling.













## Return Material Authorization (RMA)

1. If you are an End User, contact the OEM, (Original Equipment Manufacturer) or Distributor, for service. If you are an OEM or Distributor, and want to have the PM Plus repaired; then fill out the form found on [watlow.com/rma](http://watlow.com/rma). If you have questions on the PM Plus, contact Tech Support @ 507-494-5656. All RMA's require:
  - Ship-to address
  - Bill-to addressContact name
  - Phone number
  - Method of return shipment
  - Your P.O. number
  - Detailed description of the problem
  - Any special instructions
  - Name and phone number of person returning the product
2. Prior approval and an RMA number from the customer service department is required when returning any product. Make sure the RMA number is on the outside of the carton and on all paperwork returned. Ship on a freight prepaid basis.
3. After we receive your return, we will examine it and try to verify the reason for the product failure. Unless otherwise agreed to in writing, Watlow's standard warranty provisions, which can be located at [www.watlow.com/terms](http://www.watlow.com/terms), will apply to any failed product.
4. In the event that the product is not subject to an applicable warranty, we will quote repair costs to you and request a purchase order from you prior to proceeding with the repair work.
5. Watlow reserves the right to charge for no trouble found (NTF) returns.

## Safety Information

We use note, caution and warning symbols throughout this book to draw your attention to important operational and safety information.

- A "NOTE" marks a short message to alert you to an important detail.
- A "CAUTION" safety alert appears with information that is important for protecting your equipment and performance. Be especially careful to read and follow all cautions that apply to your application.
- A "WARNING" safety alert appears with information that is important for protecting you, others and equipment from damage. Pay very close attention to all warnings that apply to your application.
- The safety alert symbol,  (an exclamation point in a triangle) precedes a general CAUTION or WARNING statement.
- The electrical hazard symbol,  (a lightning bolt in a triangle) precedes an electric shock hazard CAUTION

Symbol	Explanation
	CAUTION – Warning or Hazard that needs further explanation than label on unit can provide. Consult User's Guide for further information.
	ESD Sensitive product, use proper grounding and handling techniques when installing or servicing product.
	Unit protected by double/reinforced insulation for shock hazard prevention.
	Do not throw in trash, use proper recycling techniques or consult manufacturer for proper disposal.
	Enclosure made of Polycarbonate material. Use proper recycling techniques or consult manufacturer for proper disposal.
	Unit can be powered with either alternating current (ac) voltage or direct current (dc) voltage.
	Unit is a Listed device per Underwriters Laboratories®. It has been evaluated to United States and Canadian requirements for Process Control Equipment. UL® 61010 and CSA C22.2 No. 61010. File E185611 QUYX, QUYX7. See: <a href="http://www.ul.com">www.ul.com</a>
	Unit is a Listed device per Underwriters Laboratories®. It has been evaluated to United States and Canadian requirements for Hazardous Locations Class 1 Division II Groups A, B, C and D. ANSI/ISA 12.12.01-2007. File E184390 QUZW, QUZW7. See: <a href="http://www.ul.com">www.ul.com</a>
	Unit is compliant with European Union directives. See Declaration of Conformity for further details on Directives and Standards used for Compliance.
	Unit has been reviewed and approved by Factory Mutual as a Temperature Limit Device per FM Class 3545 standard. See: <a href="http://www.fmglobal.com">www.fmglobal.com</a>
	Unit has been reviewed and approved by CSA International for use as Temperature Indicating-Regulating Equipment per CSA C22.2 No. 24. See: <a href="http://www.csa-international.org">www.csa-international.org</a>
	Unit has been reviewed and approved by ODVA for compliance with DeviceNet communications protocol. See: <a href="http://www.odva.org">www.odva.org</a>
	Unit has been reviewed and approved by ODVA for compliance with Ethernet/IP communications protocol. See: <a href="http://www.odva.org">www.odva.org</a>

## Third Party License Guide

### Introduction

PM PLUS™ incorporates certain third party software within the product. The license terms associated with this software require we give copyright and license information and this Third Party License Terms List ("TPLTL") provides those details.

### Fonts

Roboto Copyright (C) 2008 The Android Open Source Project

Licensed under the Apache License, Version 2.0 (the "License"); you may not use this file except in compliance with the License. You may obtain a copy of the License at

<http://www.apache.org/licenses/LICENSE-2.0>

Unless required by applicable law or agreed to in writing, software distributed under the License is distributed on an "AS IS" BASIS, WITHOUT WARRANTIES or CONDITIONS OF ANY KIND, either express or implied. See the License for the specific language governing permissions and limitations under the License.

The PM Plus product firmware contains the Roboto Font. PM Plus product firmware is Copyright (C) 2019 Watlow Electric Controls, Inc.

This PM PLUS™ User's Guide is copyrighted by Watlow Electric, Inc.

©2021 Watlow Electric Manufacturing Company, all rights reserved.

Watlow® and PM PLUS™ are registered trademarks of Watlow Electric and Manufacturing Company.

Windows® is a registered trademark of Microsoft Corporation.

UL® is a registered trademark of Underwriter's Laboratories, Inc.

# Table of Contents

- Introduction ..... 2
  - Warranty..... 2
  - Technical Assistance ..... 2
  - Return Material Authorization (RMA)..... 2
  - Safety Information ..... 2
  - Third Party License Guide ..... 4
- Chapter 1: Overview ..... 9**
  - Introduction ..... 9
  - Standard Features and Benefits ..... 10
  - PM PLUS™ Operational Overview ..... 12
    - Inputs ..... 12
    - Internal Functions ..... 12
    - Outputs ..... 12
    - Configuration and Monitoring of Features Through Lists ..... 13
    - Profiles ..... 13
  - System Diagrams ..... 14
- Chapter 2: Installation ..... 20**
  - Installing the Device ..... 20
  - Isolation Block Diagram ..... 22
  - Wiring..... 22
- Chapter 3: User Interface ..... 42**
  - Touch Keys ..... 42
  - Home Screen ..... 43
    - Default Home Screen Parameters ..... 43
    - Home Screen Themes ..... 44
- Chapter 4: Operations ..... 45**
  - Operations List ..... 45
    - Default Operations Parameters/Sublists ..... 45
    - Adding Custom Parameters to the Operations List ..... 47
- Chapter 5: Setup ..... 49**
  - Default Configurations for Quick Start ..... 49
    - Configuring Parameters..... 49
    - Using Watlow Software to Configure Parameters ..... 49
  - Setup List ..... 50
    - Analog Input List..... 50
    - Digital Bus List ..... 52
    - Linearization List..... 54
    - Process Value List..... 55
    - Digital Input/Output List ..... 56
    - Limit List..... 57
    - Control Loop List..... 58
    - Output List..... 61

Alarm List .....	62
Current List .....	64
Timer List .....	64
Math List .....	65
Special Output Function .....	66
Communications List .....	69
Changing PM PLUS™ to PM PLUS™ Express .....	73
How to Enact PM PLUS™ Express .....	73
Revert from PM Express Menu to Original Configuration .....	73
Saving and Restoring Settings .....	74
Reset Original Factory Settings .....	74
Trending Screen Setup .....	75
<b>Chapter 6: Profiles .....</b>	<b>76</b>
Setting Up Global Features .....	76
Setting Up Profiles .....	76
Starting a Profile .....	77
Configuring the Function Key to Start and Stop a Profile .....	77
Configuring a Digital Input to Start and Stop a Profile .....	77
Profile List .....	78
<b>Chapter 7: Factory List .....</b>	<b>81</b>
<b>Chapter 8: Features .....</b>	<b>84</b>
Autotune .....	84
TRU-TUNE+® .....	85
Input Features .....	86
Calibration Offset .....	86
Calibration of Analog Inputs .....	88
Filter Time Constant .....	89
Sensor Backup .....	90
Set Minimum Set Point and Maximum Set Point .....	90
Scale High and Scale Low .....	90
Range High and Range Low .....	91
Remote Set Point via an Analog Signal .....	91
Ten Point Linearization .....	92
Output Features .....	92
Duplex .....	92
NO-ARC Relay .....	92
Retransmitting a Process Value or Set Point .....	93
Cool Output Curve .....	94
Resetting a Tripped Limit .....	94

Control Methods . . . . .	95
Output Configuration . . . . .	95
Auto (closed loop) and Manual (open loop) Control . . . . .	95
On-Off Control . . . . .	96
Proportional and (P) Control . . . . .	97
Proportional and Integral (PI) Control . . . . .	97
Proportional, Integral and Derivative (PID) Control . . . . .	98
Dead Band . . . . .	98
Variable Time Base . . . . .	99
Single Set Point Ramping . . . . .	99
Compressor Control . . . . .	100
Differential Control . . . . .	101
Ratio Control . . . . .	101
Duplex Control . . . . .	101
Motorized Valve Control . . . . .	101
Timer Function . . . . .	101
Alarms . . . . .	103
Process and Deviation Alarms . . . . .	103
Set Points . . . . .	103
Hysteresis . . . . .	104
Latching . . . . .	104
Silencing Alarms . . . . .	105
Blocking Alarms . . . . .	105
Current Sensing . . . . .	105
Open and Shorted Load Circuit Detection . . . . .	105
Open Loop Detection . . . . .	106
Programming the Function Key . . . . .	106
Security Features . . . . .	106
Read Lock and Set Lock Levels . . . . .	106
Passwords . . . . .	108
Modbus® - Using Programmable Memory Blocks . . . . .	109
CIP Communications: DeviceNet or EtherNet/IP . . . . .	110
CIP Implicit Assemblies . . . . .	110
Compact Assembly Class . . . . .	111
Modifying Implicit Assembly Members . . . . .	111
PCCC - (Programmable Controller Communications Commands) . . . . .	111
Profibus DP (Decentralized Peripherals) . . . . .	112

<b>Chapter 9: Applications</b> .....	<b>113</b>
Example 1: Single Loop Control .....	113
Example 2: Sensor Backup .....	113
Example 3: Square Root .....	114
Example 4: Ratio .....	114
Example 5: Differential .....	115
Example 6: Wet Bulb/Dry Bulb .....	116
Example 7: Vaisala .....	116
Example 8: Motorized Valve Control .....	117
<b>Chapter 10: Appendix</b> .....	<b>118</b>
Troubleshooting Alarms, Errors and Control Issues .....	118
Modbus® Programmable Memory Blocks .....	123
CIP Implicit Assemblies .....	126
Specifications .....	130
CE Letter of Conformity .....	134



# Chapter 1: Overview

## Introduction

Watlow's PM PLUS™ has an intuitive interface with a smooth touch keypad for easy programming and readability. This reduces complexity at the front of the control. Using Composer or Configurator is highly desirable to program the PM. The PM PLUS™ is compatible with EZ-ZONE PM controllers and connects via Bluetooth® to our EZ-LINK™ mobile app for remote access configuration and monitoring, if Bluetooth® was ordered in the part number.

The PM PLUS™ can be ordered as a PID controller or an integrated controller with multiple functions combined. Look for the device configuration code on the product label to confirm which functional options are included on your device. Upon power up, you can see the firmware revision and Bluetooth® logo, if enabled, on the device display and if Bluetooth® is part of the Part number.



PM6 Plus



PM8 Plus



PM9 Plus

### Comparison of Available Features

	EZ-ZONE PM6	PM6 PLUS	EZ-ZONE PM8/9	PM8/9 PLUS
Display Type	7 segment LED	LCD	7 segment LED	LCD
Multi Language (English, German, Spanish)	None	Yes	None	Yes
Keypad Interface Type	Elastomer	SMOOTH-TOUCH™	Elastomer	SMOOTH-TOUCH™
Express Model Available	Yes	None	Yes	None
PID Loops	1	1	2	2
Profile Ramp/Soak	40 total steps	40 total steps	40 total steps	40 total steps
Profile Battery Backup and Real Time Clock	None	None	Yes	Yes
Number of Digital Inputs/Outputs	0/2	0/2	0/2/6/8	0/2/6/8
Number of Outputs	1 to 4	1 to 4	1 to 4	1 to 4
Integrated Safety Limits	Yes, 1	Yes, 1	Yes, 1	Yes, 1
Independent Safety Limit	Yes	None	Yes	None
Maximum Power Output	15A NO-ARC	15A NO-ARC	15A NO-ARC	15A NO-ARC
Current Measurement (Accepts 0-50mA Signal From External Current Transformer)	Yes	Yes	Yes	Yes
Standard Bus Communications	Yes	Yes	Yes	Yes
Bluetooth® Technology	Yes	Yes	None	Yes
Field Bus Communications (Modbus® RTU 232/485, EtherNet/IP™, Modbus® TCP, DeviceNet™, PROFIBUS DP, SAE J1939 CAN bus)	Yes	Yes	Yes	Yes
10-Point Calibration Offset	Yes	Yes	Yes	Yes
Ratio, Differential and Square-Root	Yes	Yes	Yes	Yes
Sensor Compensation Curves-Altitude (Pressure) and Vaisala RH	Yes	Yes	Yes	Yes
Motorized Valve Control (Without Feedback)	Yes	Yes	Yes	Yes
Wet Bulb/Dry Bulb	Yes	Yes	Yes	Yes
Cascade	None	None	Yes	Yes
Countdown Timer	Yes	Yes	Yes	Yes

---

# Standard Features and Benefits

## **Intuitive menu flow**

- Reduces menu structure to a list of lists allowing the controller to be easily configured
- Offers easy to read characters and color coding making the display visible from many angles

## **SMOOTH TOUCH keypad**

- Eliminates contamination points on the front of the controller
- No mechanical components will wear out
- Creates a better seal on front panel
- Easy to clean

## **Bluetooth® compatible with EZ-LINK™ mobile app**

- Provides full descriptions of parameters and error codes
- Allows remote access capabilities without the use of cables or converters
- Provides the ability to configure the product and save parameter sets

## **Integrated PID and limit controller**

- Reduces wiring time and termination complexity compared with connecting discrete products
- Decreases required panel space
- Lowers installation costs
- Increases user and equipment safety for over/under temperature conditions

## **High amperage power control output**

- Drives 15 ampere resistive loads directly
- Reduces component count
- Decreases cost of ownership

## **Current monitoring**

- Detects heater current flow and provides alarm indication of failed output device or heater load
- Drives output on open or shorted heater

## **Serial communication capabilities**

- Provides a wide range of protocol choices including Modbus® RTU, EtherNet/IP™, Modbus® TCP, PROFIBUS DP, DeviceNet™ and J1939 CAN bus
- Supports network connectivity to a PC or PLC

## **Enhanced control options**

- Easily handles complex process problems such as cascade, ratio, differential, square-root, motorized valve control without slidewire feedback, wet-bulb/dry-bulb, compressor control and peltier loads

## **Countdown timer option**

- Provides batch process control
- Supports set point change during countdown

### **10-point linearization curve**

- Improves sensor accuracy

### **EZ-LINK™ mobile application for iPhone® and Android™**

- Expedites controller setup with intuitive navigation
- Simplifies setting parameters with plain text names and descriptions
- Connects quickly and easily via Bluetooth® wireless communications

### **Configuration communications with software**

- Includes Watlow standard bus communications used by COMPOSER®

### **Advanced PID control algorithm**

- Offers TRU-TUNE®+ adaptive control to provide tighter control for demanding applications
- Provides auto-tune for fast, efficient start-up

### **Built-in sensor compensation curves**

- Saves cost of buying compensated sensors
- Includes Vaisala RH and altitude (pressure) curves

### **Remote set point operation**

- Supports convenient set point manipulation from a remote device such as a master control or PLC

### **Profile capability**

- Offers pre-programmed process control
- Allows ramp/soak programming with 40 total steps

### **Retransmit output**

- Supports industry needs for recording

### **Factory Mutual (FM) approved over/under limit with auxiliary outputs**

- Increases user and equipment safety for over/under temperature conditions

### **Memory for saving and restoring parameter settings**

- Decreases service calls and time down

### **Agency approvals: UL® listed, CSA, CE, RoHS, W.E.E.E., FM, SEMI F47-0200, Class 1, Div. 2 rating on selected models**

- Assures prompt product acceptance
- Reduces end product documentation costs

### **Touch-safe package**

- Increases safety for installer/operator
- Complies with IP2X requirements

### **Programmable function key**

- Enables simple, one-touch operation of user-defined, repetitive activities

### **Programmable menu system**

- Reduces setup time and increases operator efficiency

### **Three-year warranty**

- Provides product support and reliability

---

# PM PLUS™ Operational Overview

The PM PLUS receives information from an input, performs an internal function as a response to that input, then causes a resulting output. All of these - the inputs, the internal functions, and the outputs - are configurable. A single PM PLUS™ can carry out several functions at the same time, such as PID control, checking for a limit condition, monitoring for several alarm situations, etc.

You may configure up to four profiles to automate a sequence of up to ten steps per profile, to further customize and extend the application of the device.

## Inputs

Inputs provide the information a programmed procedure can act upon. A basic example is a sensor monitoring the temperature of a part being heated or cooled. Each analog input typically uses a thermocouple or RTD to read the process temperature or the volts, current or resistance from various devices.

Optional digital input/output (DIO) hardware can be used as either an input or an output. Each DIO must be configured as either an input or output. A digital input allows for a specific function to occur. The Function Key can also be programmed to allow for a specific function to occur.

## Internal Functions

A function is a user-programmed internal process that uses input signals to calculate a value and then perform an action, i.e.:

- Compare an input value to the set point and calculate the optimal power for a heater
- Detect a failure of the primary sensing device and trip a contactor to remove power from the heating element
- When a digital input signal changes, allows for a specific function to occur.
- Evaluate an incoming temperature to determine an alarm state (on or off)

Each internal function is associated with one source, or instance. For example, a control equipped with DIO, can be configured to respond to one of the four alarms.

## Outputs

Outputs are functions or actions configured to respond to information provided by an internal function. Some output examples are: removal of the control voltage to a contactor; operating a heater, turning a light on or off, unlocking a door, etc.

You can assign outputs to any input, and may assign more than one output to respond to a single instance of a function. For example, alarm 2 could be used to trigger a light connected to output 1 and a siren connected to DIO 5.

# Configuration and Monitoring of Features Through Lists

PM PLUS™ features and parameters are structured in lists that you can access via the smooth-touch key interface on the front panel for easy configuration and monitoring. You can also access lists remotely if you prefer, using our EZ-LINK app, Composer Software, or Configurator Software.

List	Description
Operations List	This list is used to monitor or change runtime settings such as the high set point of the limit, or monitor things like the time remaining in a profile step. It is also used to access the main configuration lists referenced here.
Setup List	This is used prior to operation to set up equipment related settings such as input type and output cycle time.
Profile List	If equipped with this feature you will use this list to configure up to 4 profiles with up to ten steps each.
Factory List	This list doesn't affect runtime operations. It is used to adjust hardware settings like passwords or the appearance of the Home Screen, or to view the control part number.



PM6 Plus



PM8 Plus



PM9 Plus

## Profiles

A profile is a sequence of steps. When a profile runs, the controller automatically executes its steps in sequence. The step type determines what action the controller performs. Steps can change temperatures and other process values gradually over time, maintain temperatures and process values for specific periods, or repeat a sequence of steps numerous times. At each step the profile can activate or deactivate outputs that control other equipment. Also a step can have the controller wait for specific conditions before proceeding such as, waiting for a switch closure and/or a specific process value to be detected by a sensor.

## Input Events and Output Events

When a Profile step is programmed as a "Wait For Event Input" will wait for the "Input Event" to be in the proper state before it will proceed to the next step of a Profile. Event Outputs will allow you to turn "On" or "Off", or "leave as is"; in each step of a Profile.

# System Diagrams

## PM PLUS Model 1/8 DIN System Diagram Without 6 Digital I/O (slot D), Without Communications (slot E)

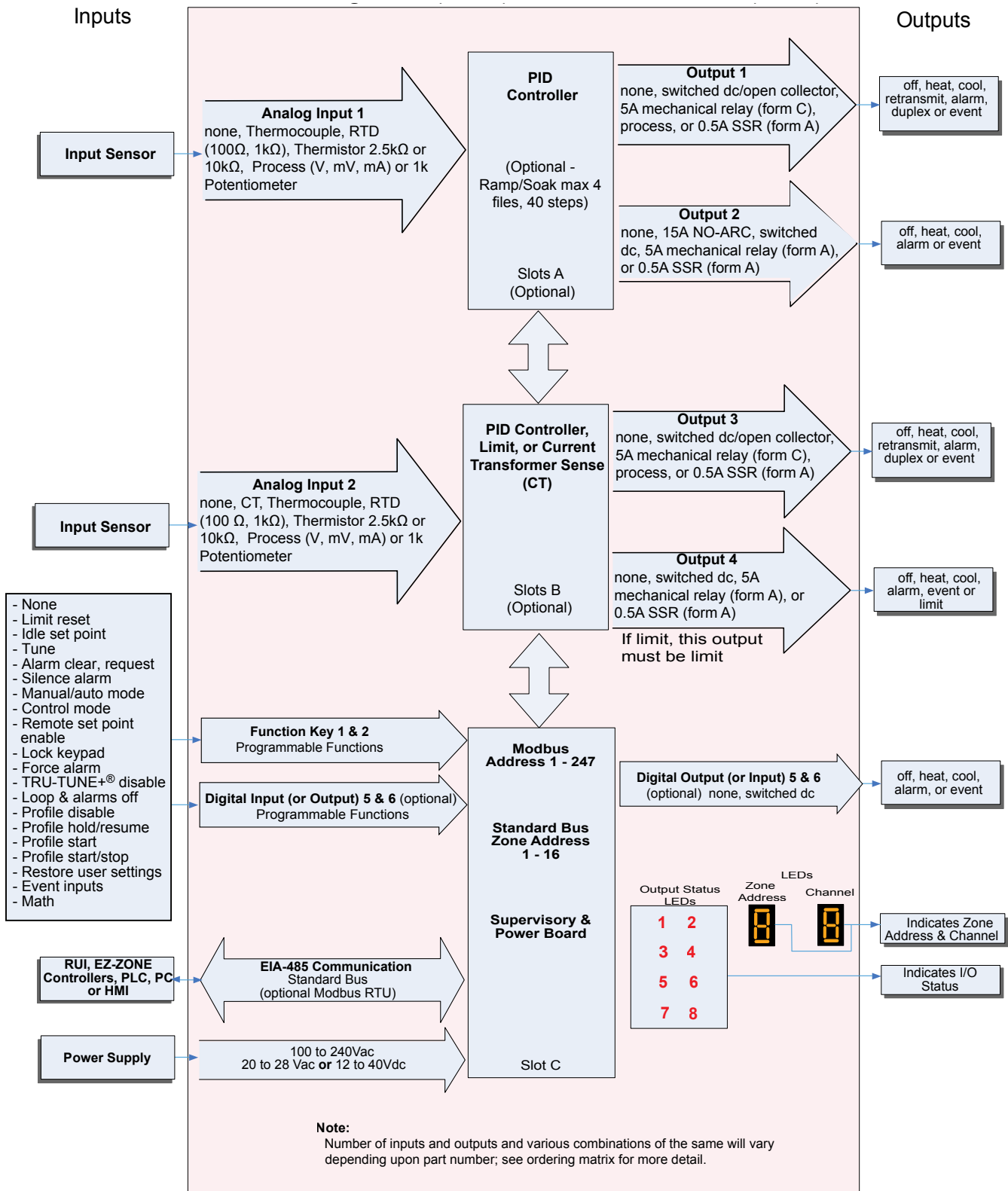

## PM Model 1/8 System Diagram Without 6 Digital I/O (slot D), With Communications (slot E)

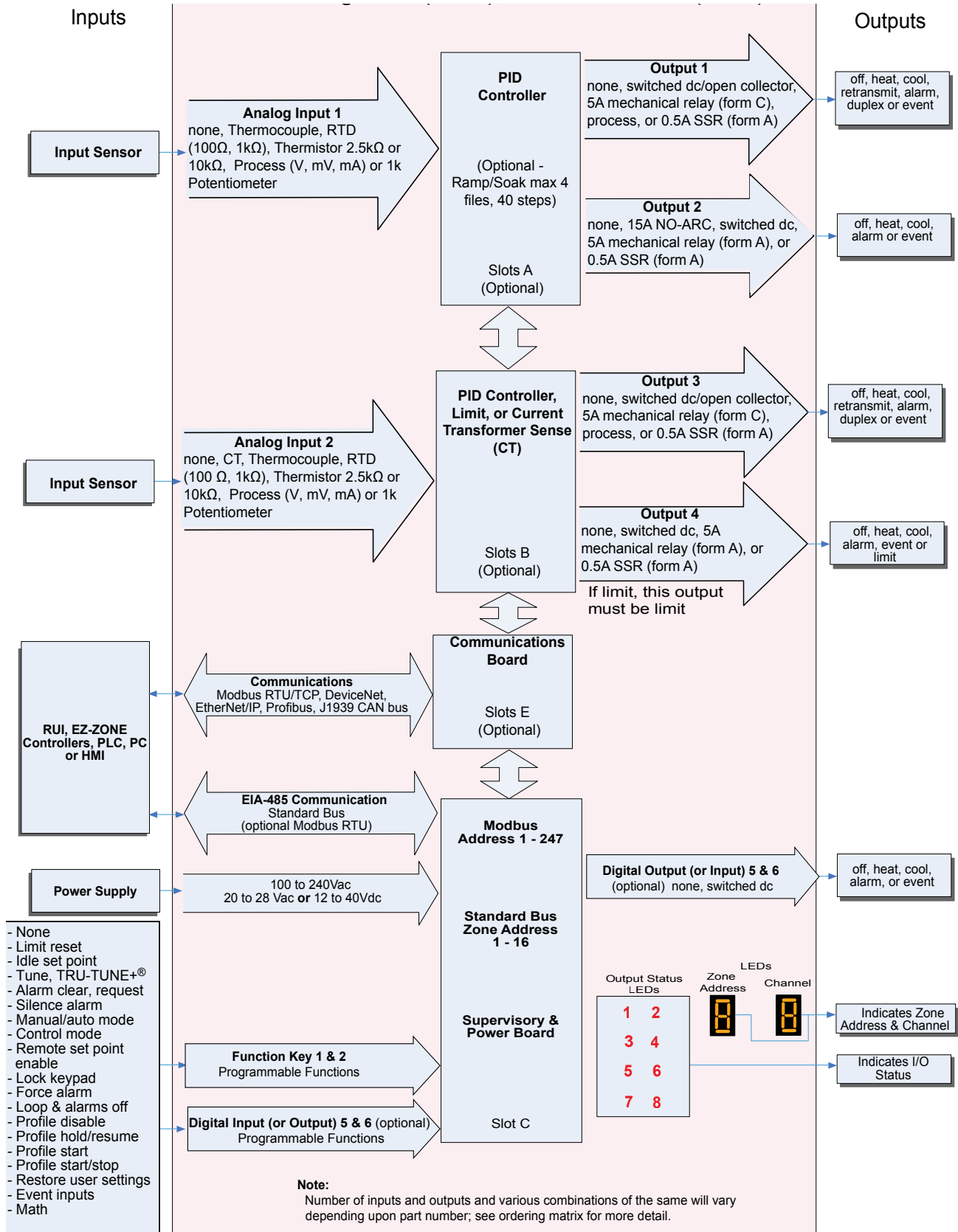

# Current Monitoring - with Current Transformer, without Communications Card

- Detects heater current flow
- Provides an alarm indication of a failed-load issue.

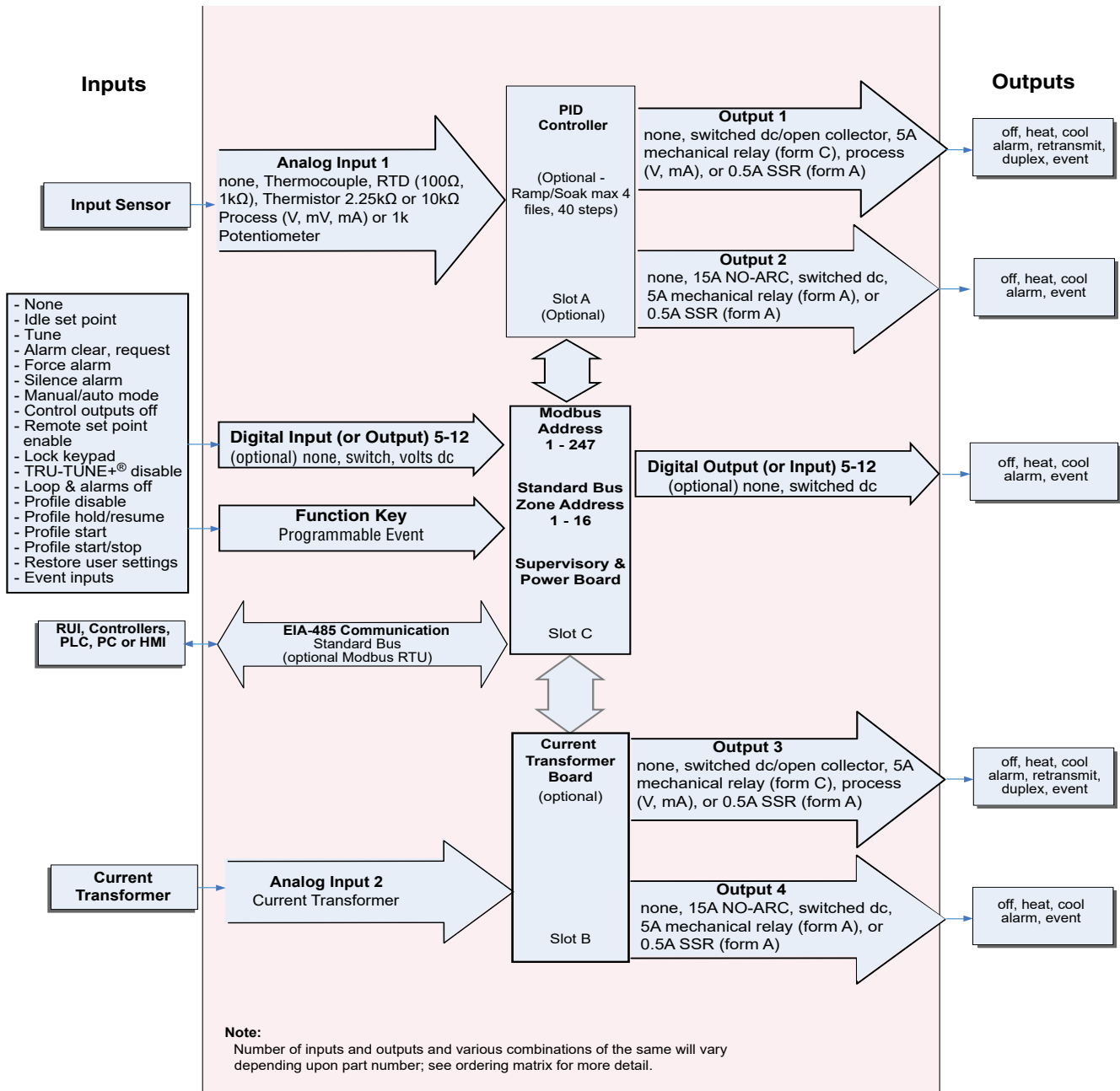



## Remote Set Point Operation With Auxillary Input, Without Communications Card

- Remote Set Point Operation supports efficient set point manipulation from a remote device, such as a master control or PLC.

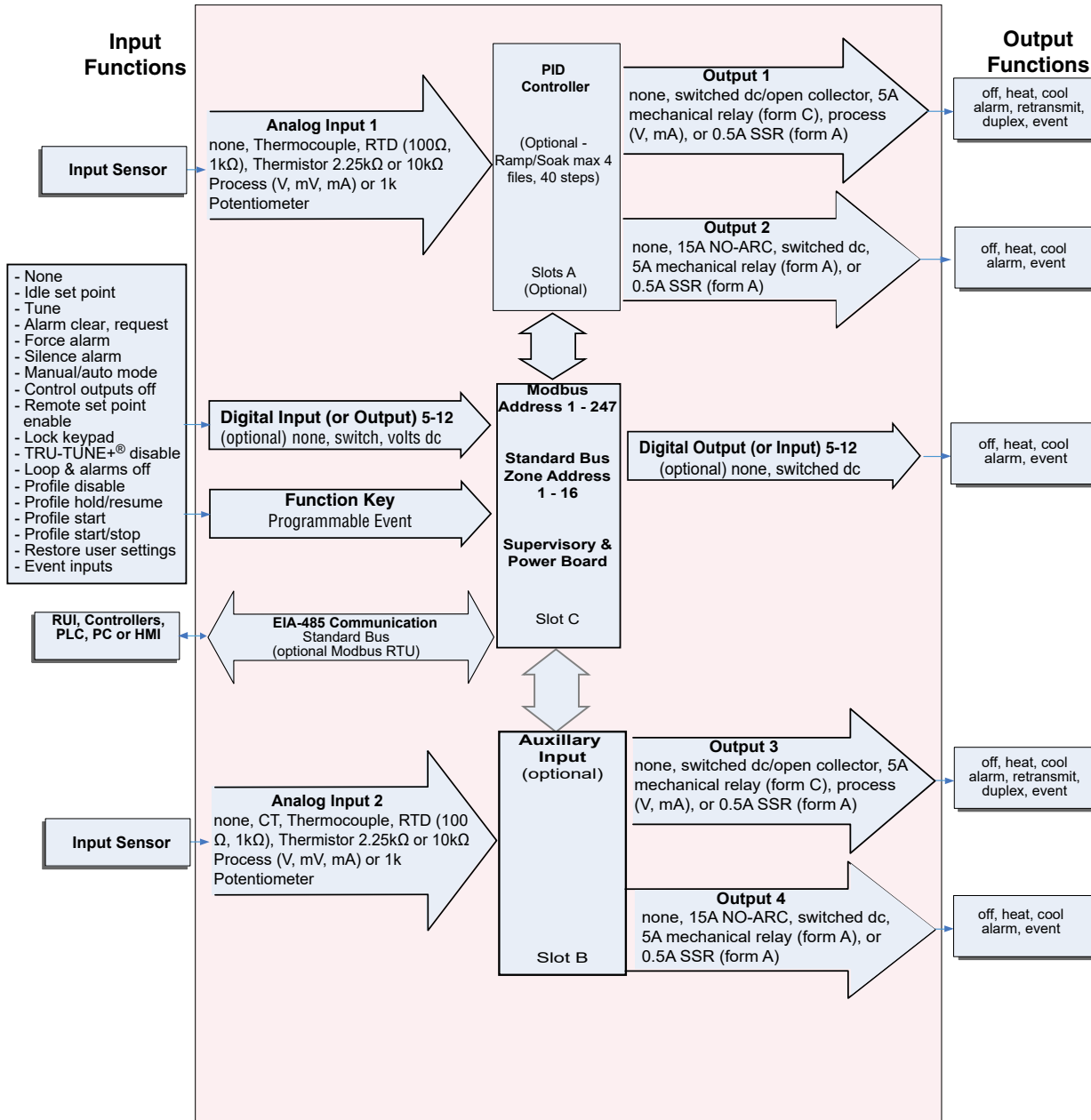

**Note:**  
Number of inputs and outputs and various combinations of the same will vary depending upon part number; see ordering matrix for more detail.

# Integrated PID and Limit Controller with Limit, Without Communications Card

- Reduces wiring time and termination complexity compared to connecting separate products
- Reduces panel space
- Reduces installation costs
- Increases dependability with backup control sensor operation
- Increases user and equipment safety for over-under temperature conditions

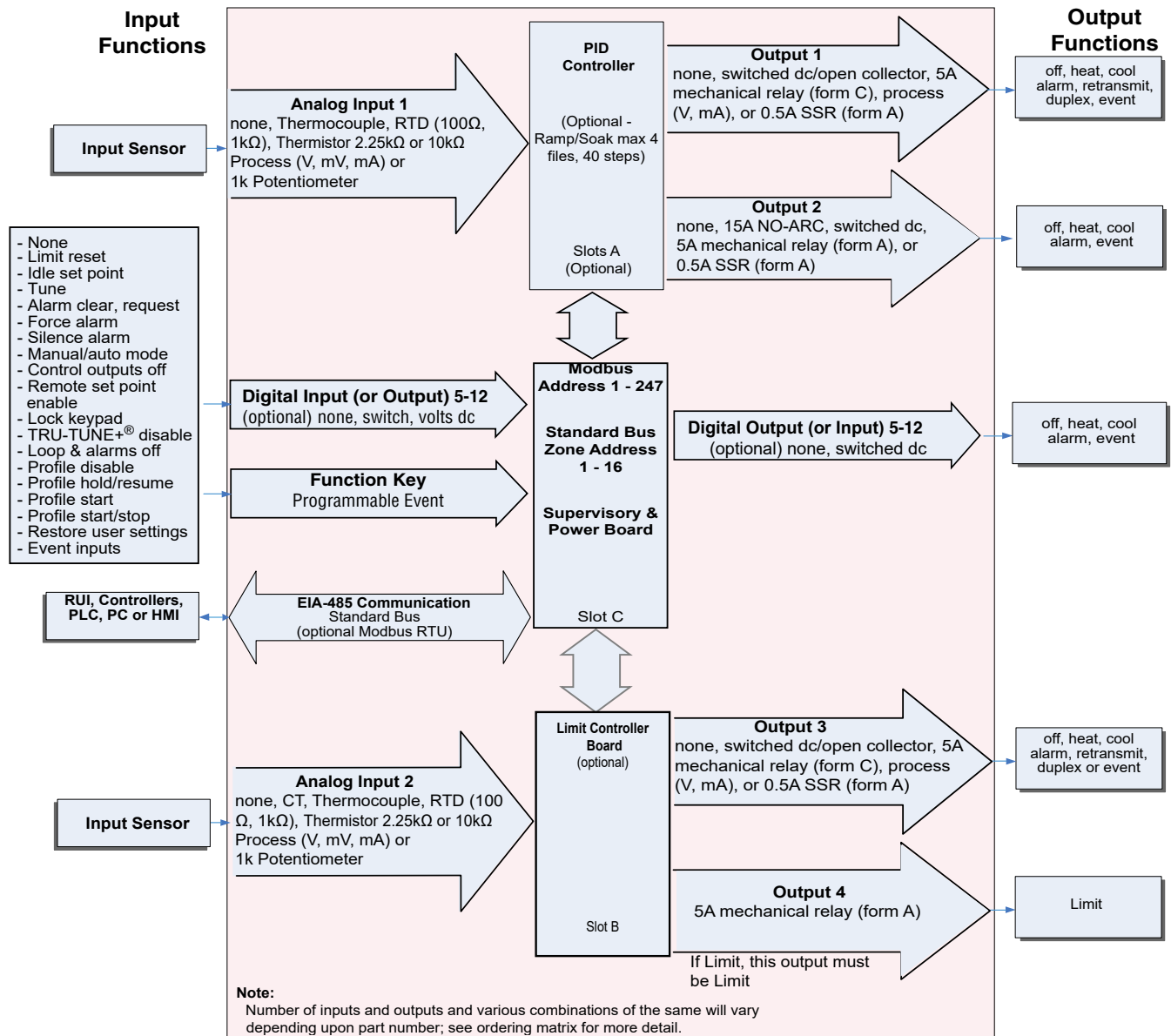

## Expanded Serial Communications

- Supports network connectivity to a PC or PLC
- Available in a wide range of protocol choices, including Modbus® RTU, EtherNet/IP™, Modbus® TCP

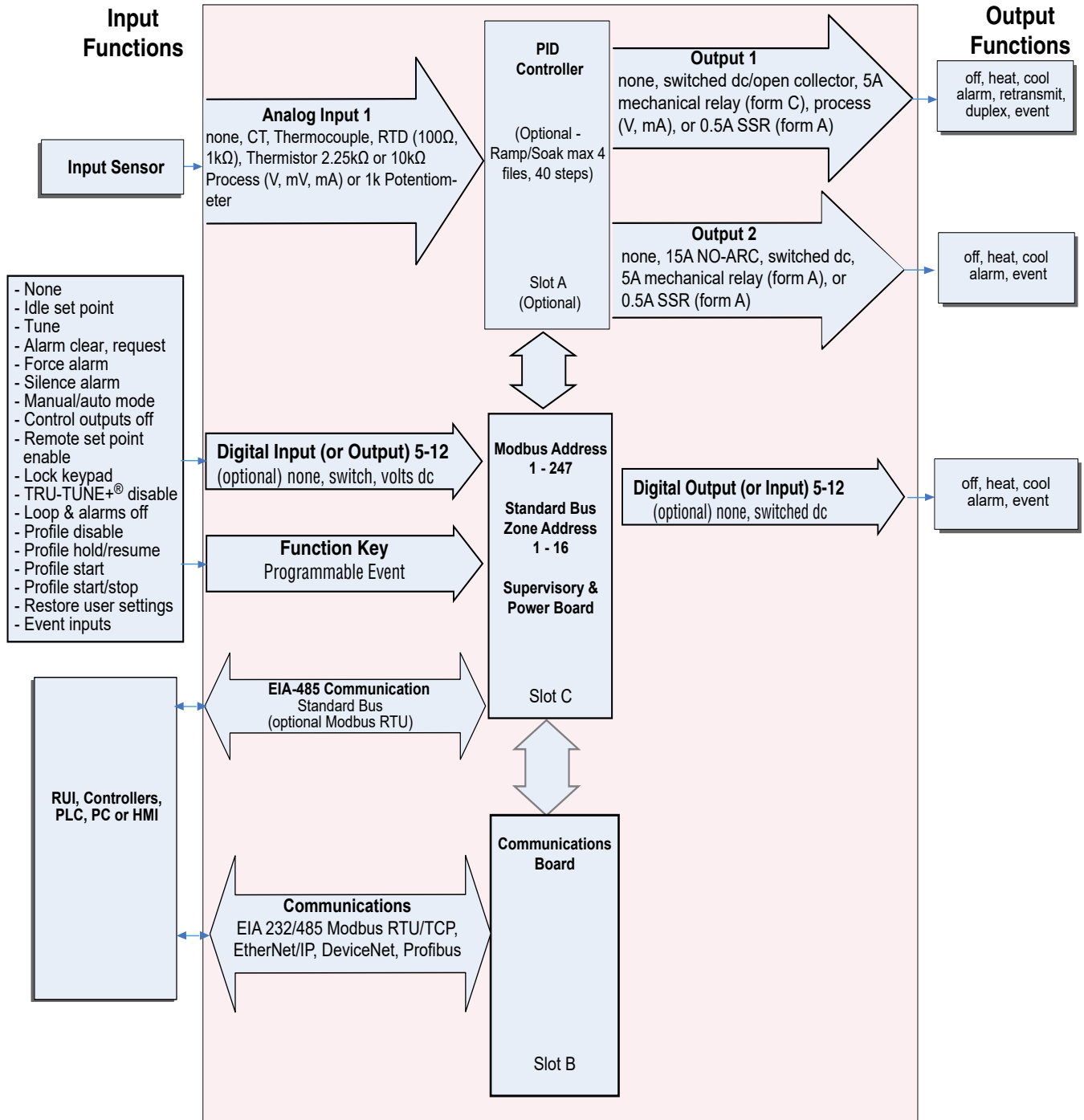

# Chapter 2: Installation

## Installing the Device

1. Make the panel cutout using the measurements in Figure 2-1 or Figure 2.-2 .
2. Remove the green terminal connectors and the mounting collar assembly.
3. Insert the controller into the panel cutout from the front.
4. Orient the collar base so the flat side faces front and the screw openings are on the sides (see figure 2-3 and 2-4), then slide the base over the back of the controller.
5. Slide the mounting bracket over the controller with the screws aligned to the collar base. Push the bracket gently but firmly until the hooks snap into the slots in the case.
6. Tighten the four #6-19 x 1.5 in. screws (two on each side) with a Phillips screwdriver until the device is flush to the panel (3 to 4 in-lbs torque). See figure 2-4. (Only one screw on each side on the PM6 PLUS.)
7. Reinstall the terminal connectors to their original locations. (Or first connect field wiring as indicated in this guide and then reinstall the connectors).

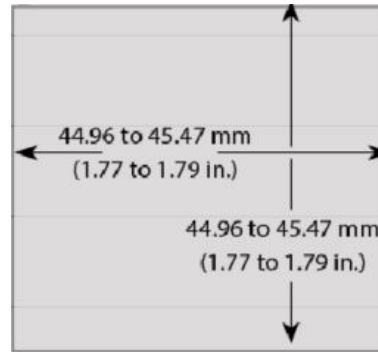

Figure 2-1: PM6 PLUS Panel Cutout Mounting Dimensions

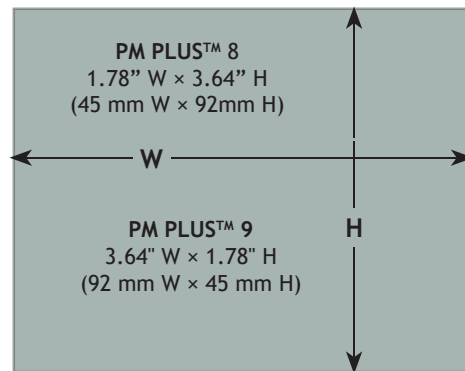

Figure 2-2: PM8/9 PLUS Panel Cutout Mounting Dimensions

	This equipment is suitable for use in Class 1, Div. 2, Groups A, B, C and D or Non-Hazardous locations only. Temperature Code T4A. Note: Class 1, Div 2 is only valid if the last 2 characters in the part # are "12".
	<b>EXPLOSION HAZARD.</b> Substitution of component may impair suitability for Class 1, Div. 2.
	<b>EXPLOSION HAZARD.</b> Do not disconnect equipment unless power has been switched off or the area is known to be nonhazardous.



Figure 2-3: PM8/9 PLUS Panel Cutout



Figure 2-4: PM8/9 PLUS Panel Cutout

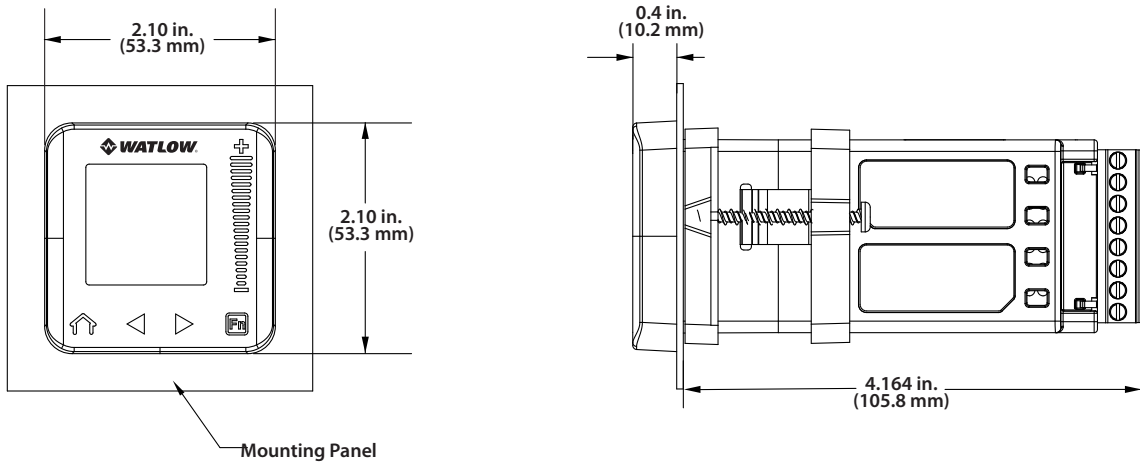

Figure 2-5: PM6 PLUS Mounting Dimensions

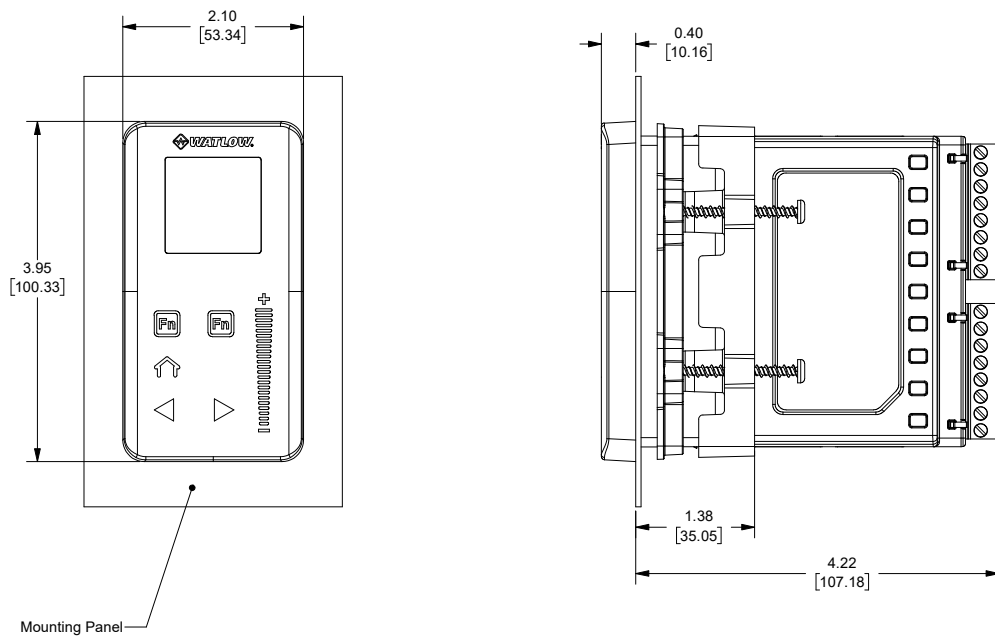

Figure 2-7: PM8 PLUS Mounting Dimensions

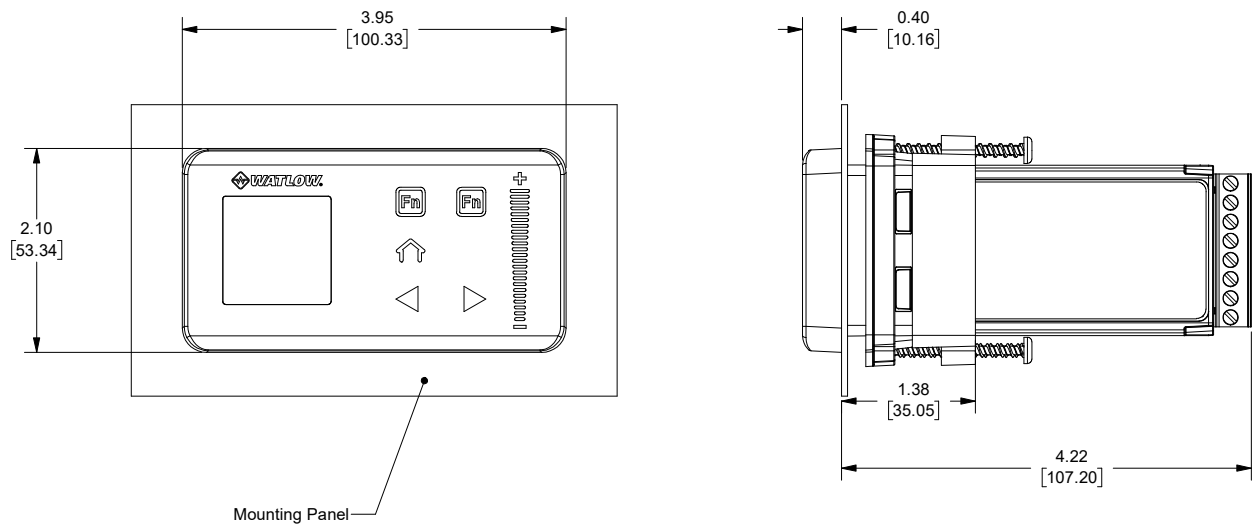

Figure 2-8: PM9 PLUS Mounting Dimensions

## Wiring Notes

Maximum wire size termination and torque rating:

0.0507 to 3.30 mm<sup>2</sup> (30 to 12 AWG) single-wire termination or two 1.31 mm<sup>2</sup> (16 AWG)

0.56 Nm (5.0 in-lb.) torque

Adjacent terminals may be labeled differently depending on the model number.

Do not connect wires to unused terminals.

Maintain electrical isolation between analog input 1, digital input-outputs, switched dc/open collector outputs and process outputs to prevent ground loops.

This equipment is suitable for use in CLASS I, DIVISION 2, Groups A, B, C and D or Non-Hazardous locations only. Temperature Code T4A

## Wiring Warnings

Use National Electric (NEC) or other country-specific standard wiring and safety practices when wiring this controller to a power source, electrical sensors or peripheral devices. Failure to do so may result in damage to equipment and property, and/or injury or loss of life.

Explosion Hazard - Dry contact closure Digital Inputs shall not be used in Class I Division 2 Hazardous Locations unless switch used is approved for this application.

Explosion Hazard - Substitution of component may impair suitability for CLASS I, DIVISION 2.

Explosion Hazard - Do not disconnect while the circuit is live or unless the area is known to be free of ignitable concentrations of flammable substances.

# Isolation Block Diagram

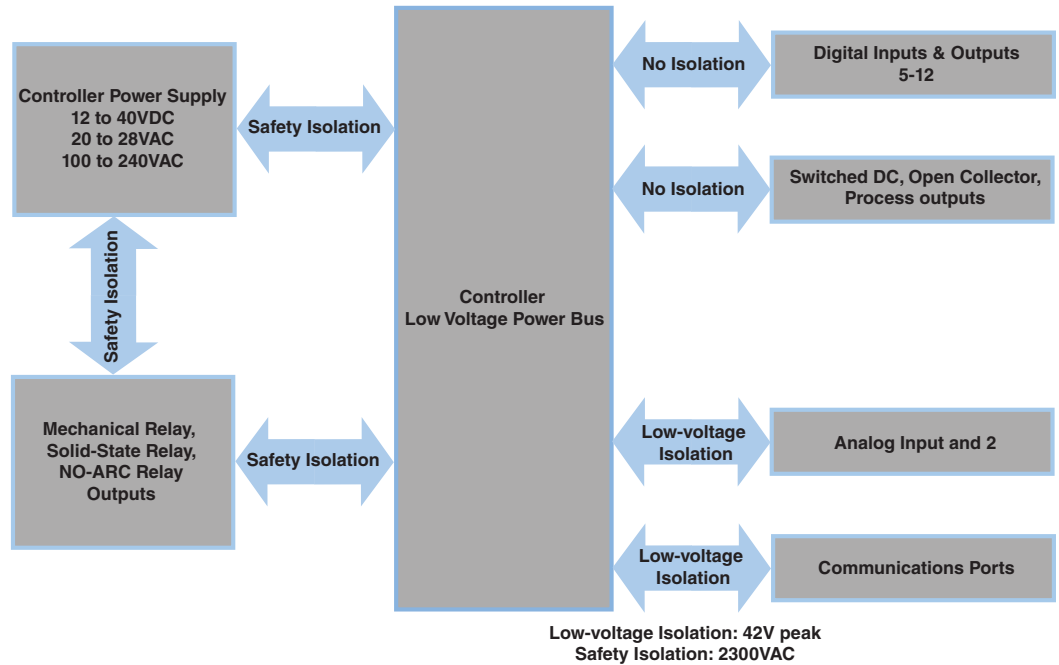

## Wiring

### 1/8 DIN PM8/9 Connector Slot Orientation Back View

#### Slot Orientation - Back View

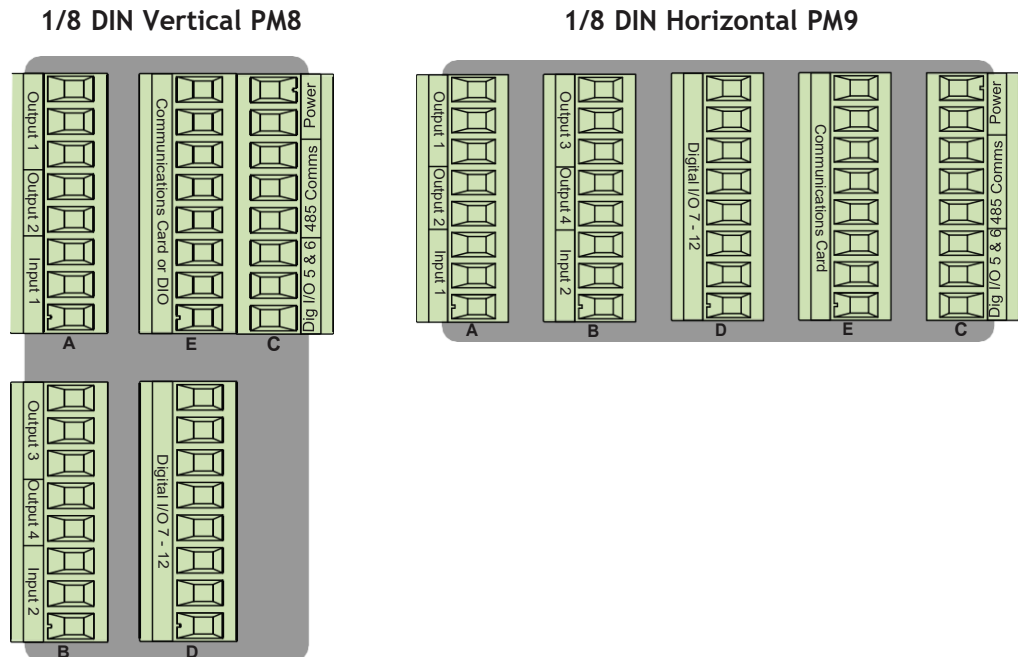

## Wiring Notes

Maximum wire size termination and torque rating:

0.0507 to 3.30 mm<sup>2</sup> (30 to 12 AWG) single-wire termination or two 1.31 mm<sup>2</sup> (16 AWG)

0.56 Nm (5.0 in.-lb.) torque

Adjacent terminals may be labeled differently depending on the model number.

Do not connect wires to unused terminals.

Maintain electrical isolation between analog input 1, digital input-outputs, switched dc/ open collector outputs and process outputs to prevent ground loops.

This equipment is suitable for use in CLASS I, DIVISION 2, Groups A, B, C and D or Non-Hazardous locations only. Temperature Code T4A

## Wiring Warnings

Use National Electric (NEC) or other country-specific standard wiring and safety practices when wiring this controller to a power source, electrical sensors or peripheral devices. Failure to do so may result in damage to equipment and property, and/or injury or loss of life.

Explosion Hazard - Dry contact closure Digital Inputs shall not be used in Class I Division 2 Hazardous Locations unless switch used is approved for this application.

Explosion Hazard – Substitution of component may impair suitability for CLASS I, DIVISION 2.

Explosion Hazard - Do not disconnect while the circuit is live or unless the area is known to be free of ignitable concentrations of flammable substances.

## 1/16 DIN PM6 Connector Back View

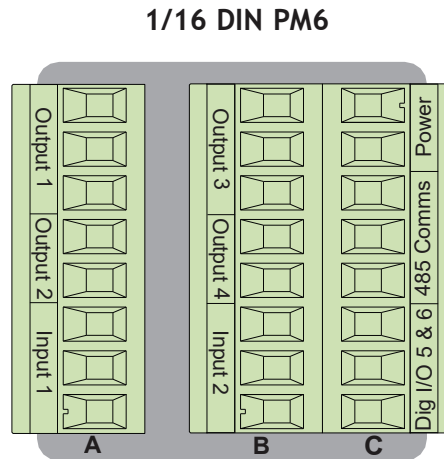

### Note:

Slot B above can also be configured with a communications card.

### Low Power

[PM]\_\_ [3,4] - - - - -

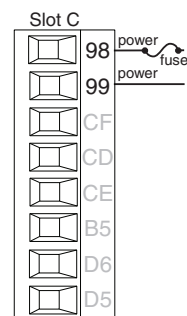

- Minimum/Maximum Ratings
- 12 to 40VDC
- 20 to 28VAC) Semi Sig F47
- 47 to 63 Hz
- 10 VA Max. Power Consumption for PM6
- 14 VA Max. Power Consumption for PM8/9

### High Power

[PM]\_\_ [1,2] - - - - -

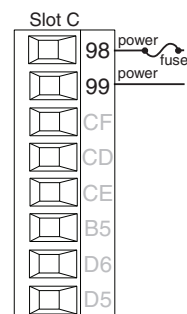

- Minimum/Maximum Ratings
- 85 to 264VAC
- 100 to 240VAC Semi Sig F47
- 47 to 63 Hz
- 10 VA Max. Power Consumption for PM6
- 14 VA Max. Power Consumption for PM8/9

## Wiring Notes

Maximum wire size termination and torque rating:

0.0507 to 3.30 mm<sup>2</sup> (30 to 12 AWG) single-wire termination or two 1.31 mm<sup>2</sup> (16 AWG)

0.56 Nm (5.0 in-lb.) torque

Adjacent terminals may be labeled differently depending on the model number.

Do not connect wires to unused terminals.

Maintain electrical isolation between analog input 1, digital input-outputs, switched dc/open collector outputs and process outputs to prevent ground loops.

This equipment is suitable for use in CLASS I, DIVISION 2, Groups A, B, C and D or Non-Hazardous locations only. Temperature Code T4A

## Wiring Warnings

Use National Electric (NEC) or other country-specific standard wiring and safety practices when wiring this controller to a power source, electrical sensors or peripheral devices. Failure to do so may result in damage to equipment and property, and/or injury or loss of life.

Explosion Hazard - Dry contact closure Digital Inputs shall not be used in Class I Division 2 Hazardous Locations unless switch used is approved for this application.

Explosion Hazard - Substitution of component may impair suitability for CLASS I, DIVISION 2.

Explosion Hazard - Do not disconnect while the circuit is live or unless the area is known to be free of ignitable concentrations of flammable substances.

## Digital Input 5 - 6

[PM] \_ \_ [2,4] \_ \_ - \_ \_ \_ \_ \_

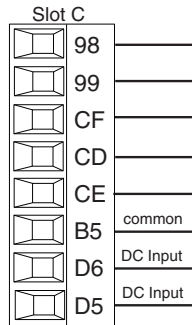

### Digital Input

- Update rate 10 Hz
- Dry contact or dc voltage

### DC Voltage

- Input not to exceed 36V (dc) at 3mA
- Input active when > 3V (dc) @ 0.25mA
- Input inactive when < 2V

### Dry Contact

- Input inactive when > 500Ω
- Input active when < 100Ω
- Maximum short circuit 13mA

## Voltage Input

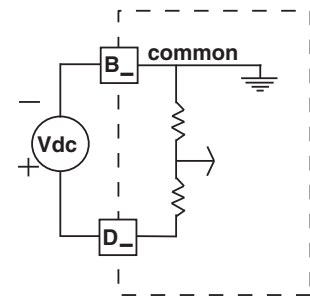

## Dry Contact

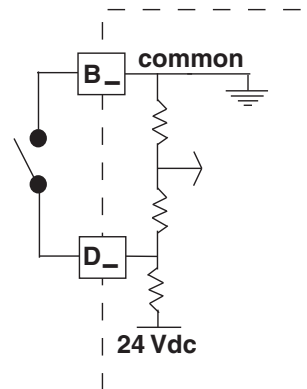

## Input 1, 2 Thermocouple

Input 1: [PM] \_ [C,R] \_ \_ \_ \_ \_ (S1/R1)

Input 2: [PM] \_ \_ \_ \_ \_ [C,R,L] \_ \_ \_ \_ \_ (S2/R2)

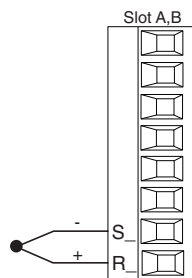

- 2kΩ maximum source resistance
- >20MΩ input impedance
- 3μA open-sensor detection
- Thermocouples are polarity sensitive. The negative lead (usually red) must be connected to S1 and/or S2.
- To reduce errors, the extension wire for thermocouples must be of the same alloy as the thermocouple.

## Input 1, 2 RTD

Input 1: [PM] \_ [C,R] \_ \_ \_ \_ \_ (S1/R1), (T1/S1/R1)

Input 2: [PM] \_ \_ \_ \_ \_ [C,R,L] \_ \_ \_ \_ \_ (S2/R2), (T2/S2/R2)

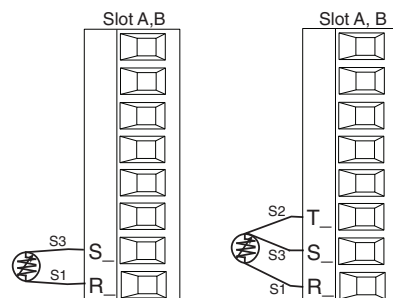

- Platinum, 100 and 1kΩ @ 0°C
- Calibration to DIN curve (0.00385 Ω/Ω/°C)
- 20Ω total lead resistance
- RTD excitation current of 0.09mA typical. Each ohm of lead resistance may affect the reading by 0.03°C.
- For 3-wire RTDs, the S1 lead (usually white) must be connected to R1 and/or R2
- For accuracy use a 3-wire RTD to compensate for lead-length resistance. All three lead wires must have the same resistance



## Wiring Notes

Maximum wire size termination and torque rating:

0.0507 to 3.30 mm<sup>2</sup> (30 to 12 AWG) single-wire termination or two 1.31 mm<sup>2</sup> (16 AWG)

0.56 Nm (5.0 in.-lb.) torque

Adjacent terminals may be labeled differently depending on the model number.

Do not connect wires to unused terminals.

Maintain electrical isolation between analog input 1, digital input-outputs, switched dc/open collector outputs and process outputs to prevent ground loops.

This equipment is suitable for use in CLASS I, DIVISION 2, Groups A, B, C and D or Non-Hazardous locations only. Temperature Code T4A

## Wiring Warnings

Use National Electric (NEC) or other country-specific standard wiring and safety practices when wiring this controller to a power source, electrical sensors or peripheral devices. Failure to do so may result in damage to equipment and property, and/or injury or loss of life.

Explosion Hazard - Dry contact closure Digital Inputs shall not be used in Class I Division 2 Hazardous Locations unless switch used is approved for this application.

Explosion Hazard – Substitution of component may impair suitability for CLASS I, DIVISION 2.

Explosion Hazard - Do not disconnect while the circuit is live or unless the area is known to be free of ignitable concentrations of flammable substances.

## Input 1, 2 Process

Input 1: [PM] \_ [C,R,] \_ \_ \_ \_ \_ (-S1/+R1),(+T1/-S1)

Input 2: [PM] \_ \_ \_ \_ \_ [C,R,L] \_ \_ \_ \_ \_ (-S2/+R2),(+T2/-S2)

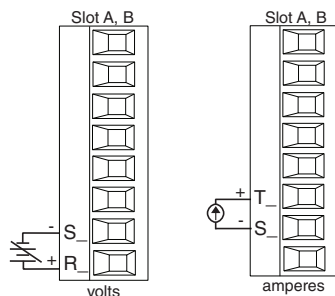

- 0 to 20mA @ 100Ω input impedance
- 0 to 10VDC @ 20kΩ input impedance
- 0 to 50mVDC @ 20kΩ input impedance
- Scalable

## Input 1,2 Potentiometer

Input 1: [PM] \_ [C,R] \_ \_ \_ \_ \_ (S1/R1)

Input 2: [PM] \_ \_ \_ \_ \_ [C,R,L] \_ \_ \_ \_ \_ (S2/R2)

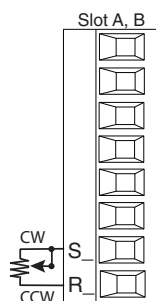

- Use a 1kΩ potentiometer.

## Input 1, 2 Thermistor

Input 1: [PM] \_ [J,N] \_ \_ \_ \_ \_ (S1/R1)

Input 2: [PM] \_ \_ \_ \_ \_ [J,P,M] \_ \_ \_ \_ \_ (S2/R2)

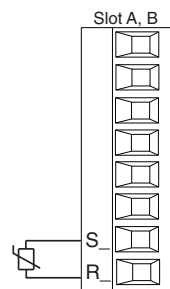

- >20MΩ input impedance
- 3μA open-sensor detection

## Input 2 Current Transformer

[PM] \_ \_ \_ \_ \_ [T] \_ \_ \_ \_ \_

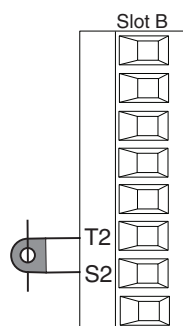

- Input range is 0 to 50mA
- Current transformer part number: 16-0246 or 1414-7055. Needs to be ordered separately.
- 100Ω input impedance
- Response time: 1 second maximum
- Accuracy +/-1 mA typical

## Wiring Notes

Maximum wire size termination and torque rating:

0.0507 to 3.30 mm<sup>2</sup> (30 to 12 AWG) single-wire termination or two 1.31 mm<sup>2</sup> (16 AWG)

0.56 Nm (5.0 in-lb.) torque

Adjacent terminals may be labeled differently depending on the model number.

Do not connect wires to unused terminals.

Maintain electrical isolation between analog input 1, digital input-outputs, switched dc/open collector outputs and process outputs to prevent ground loops.

This equipment is suitable for use in CLASS I, DIVISION 2, Groups A, B, C and D or Non-Hazardous locations only. Temperature Code T4A

## Wiring Warnings

Use National Electric (NEC) or other country-specific standard wiring and safety practices when wiring this controller to a power source, electrical sensors or peripheral devices. Failure to do so may result in damage to equipment and property, and/or injury or loss of life.

Explosion Hazard - Dry contact closure Digital Inputs shall not be used in Class I Division 2 Hazardous Locations unless switch used is approved for this application.

Explosion Hazard - Substitution of component may impair suitability for CLASS I, DIVISION 2.

Explosion Hazard - Do not disconnect while the circuit is live or unless the area is known to be free of ignitable concentrations of flammable substances.

## Example Current Transformer:

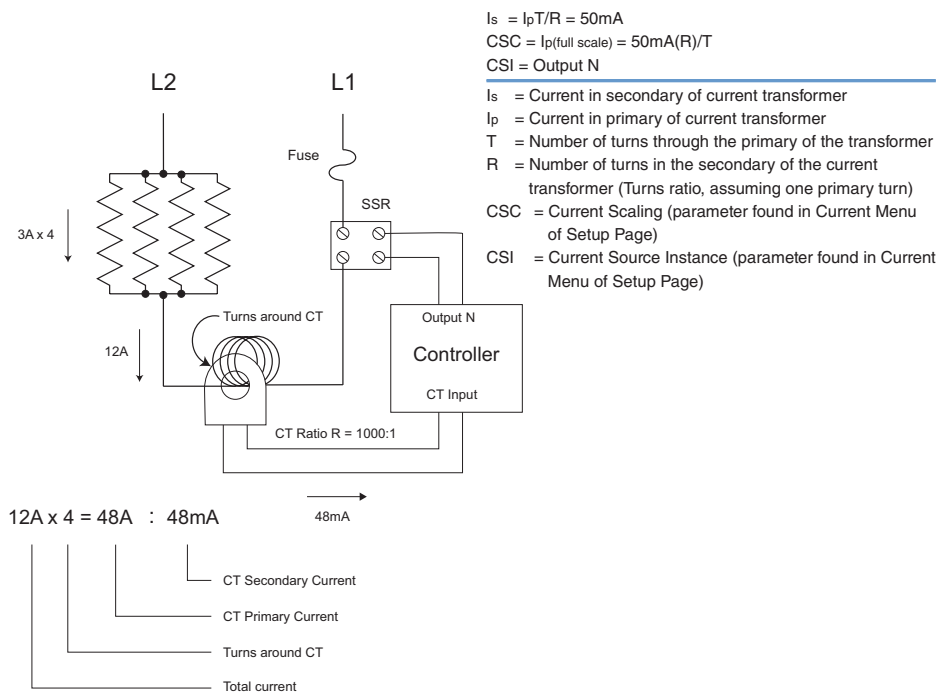

## Digital Output 5 - 6

[PM] \_ \_ [2,4] \_ \_ \_ \_ \_

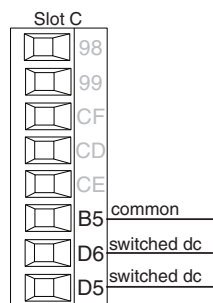

### Digital Output

- SSR drive signal
- Update rate 10 Hz
- Maximum open circuit voltage is 22 to 25V (dc)
- PNP transistor source
- Typical drive; 21mA @ 4.5V (dc) for D05, and 11mA @ 4.5V for D06
- Current limit 24mA for Output 5 and 12mA Output 6
- Output 5 capable of driving one 3-pole DIN-A-MITE
- Output 6 capable of driving one 1-pole DIN-A-MITE

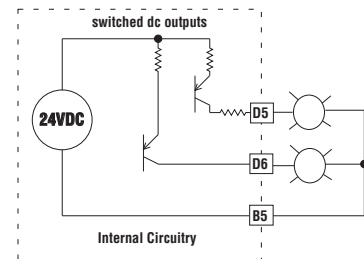

## Wiring Notes

Maximum wire size termination and torque rating:

0.0507 to 3.30 mm<sup>2</sup> (30 to 12 AWG) single-wire termination or two 1.31 mm<sup>2</sup> (16 AWG)

0.56 Nm (5.0 in.-lb.) torque

Adjacent terminals may be labeled differently depending on the model number.

Do not connect wires to unused terminals.

Maintain electrical isolation between analog input 1, digital input-outputs, switched dc/open collector outputs and process outputs to prevent ground loops.

This equipment is suitable for use in CLASS I, DIVISION 2, Groups A, B, C and D or Non-Hazardous locations only. Temperature Code T4A

## Wiring Warnings

Use National Electric (NEC) or other country-specific standard wiring and safety practices when wiring this controller to a power source, electrical sensors or peripheral devices. Failure to do so may result in damage to equipment and property, and/or injury or loss of life.

Explosion Hazard - Dry contact closure Digital Inputs shall not be used in Class I Division 2 Hazardous Locations unless switch used is approved for this application.

Explosion Hazard – Substitution of component may impair suitability for CLASS I, DIVISION 2.

Explosion Hazard - Do not disconnect while the circuit is live or unless the area is known to be free of ignitable concentrations of flammable substances.

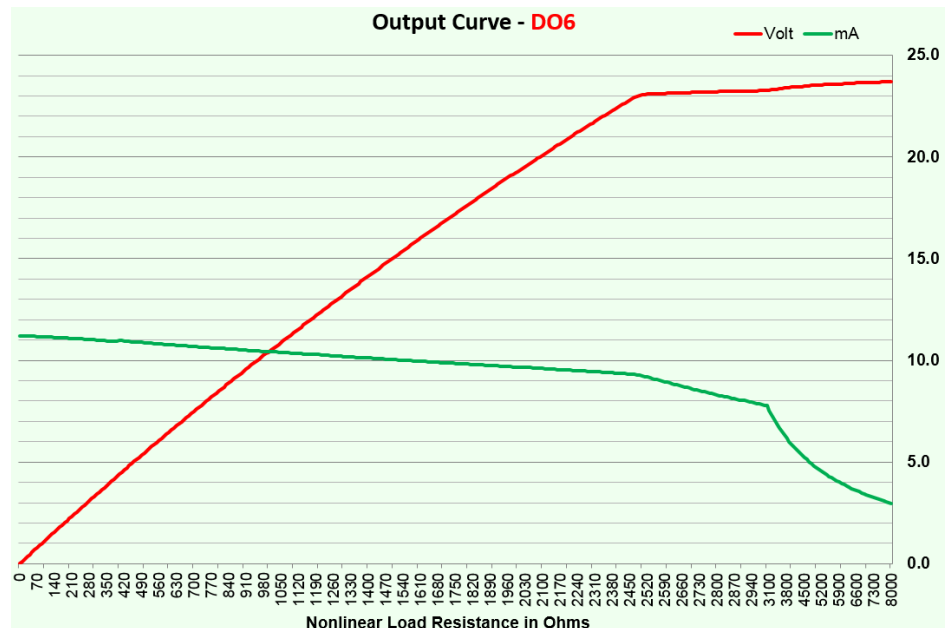
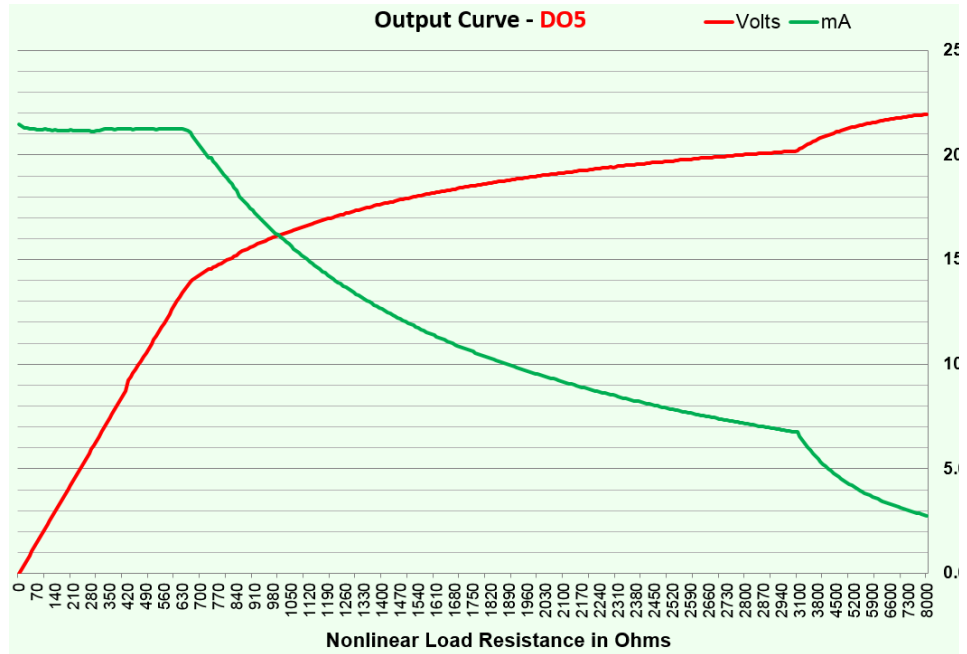

## Wiring Notes

Maximum wire size termination and torque rating:

0.0507 to 3.30 mm<sup>2</sup> (30 to 12 AWG) single-wire termination or two 1.31 mm<sup>2</sup> (16 AWG)

0.56 Nm (5.0 in-lb.) torque

Adjacent terminals may be labeled differently depending on the model number.

Do not connect wires to unused terminals.

Maintain electrical isolation between analog input 1, digital input-outputs, switched dc/open collector outputs and process outputs to prevent ground loops.

This equipment is suitable for use in CLASS I, DIVISION 2, Groups A, B, C and D or Non-Hazardous locations only. Temperature Code T4A

## Wiring Warnings

Use National Electric (NEC) or other country-specific standard wiring and safety practices when wiring this controller to a power source, electrical sensors or peripheral devices. Failure to do so may result in damage to equipment and property, and/or injury or loss of life.

Explosion Hazard - Dry contact closure Digital Inputs shall not be used in Class I Division 2 Hazardous Locations unless switch used is approved for this application.

Explosion Hazard – Substitution of component may impair suitability for CLASS I, DIVISION 2.

Explosion Hazard - Do not disconnect while the circuit is live or unless the area is known to be free of ignitable concentrations of flammable substances.

## Switched DC Wiring Example Using DO 5-6

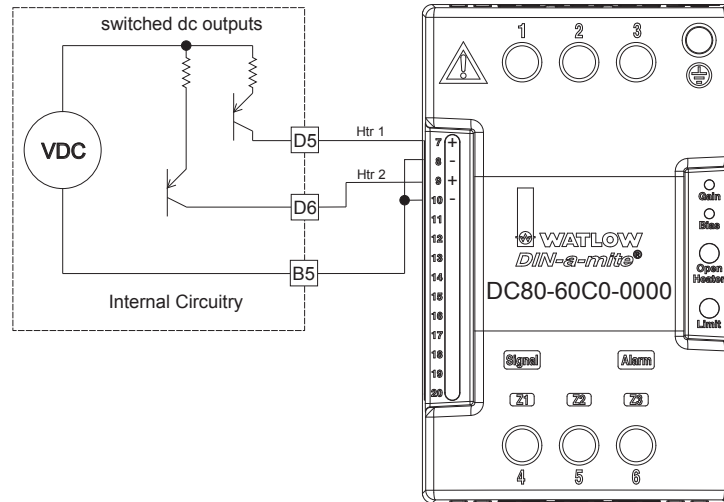

## Digital Input 7 - 12

PM [8,9] - - - - [C,D] - - - -

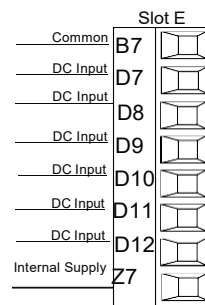

### Digital Input Event Conditions

- **Dry Contact**
  - Input inactive when > 100kΩ
  - Input active when < 50Ω
- **Voltage**
  - Input inactive when < 2V
  - Input active when > 3V
- Six user configurable digital inputs/outputs per slot
- Slot E DIO 7-12

### Voltage Input

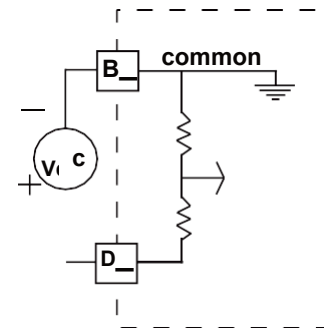

### Dry Contact

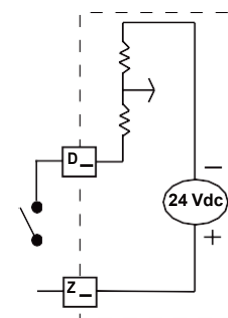

## Wiring Notes

Maximum wire size termination and torque rating:

0.0507 to 3.30 mm<sup>2</sup> (30 to 12 AWG) single-wire termination or two 1.31 mm<sup>2</sup> (16 AWG)

0.56 Nm (5.0 in.-lb.) torque

Adjacent terminals may be labeled differently depending on the model number.

Do not connect wires to unused terminals.

Maintain electrical isolation between analog input 1, digital input-outputs, switched dc/open collector outputs and process outputs to prevent ground loops.

This equipment is suitable for use in CLASS I, DIVISION 2, Groups A, B, C and D or Non-Hazardous locations only. Temperature Code T4A

## Wiring Warnings

Use National Electric (NEC) or other country-specific standard wiring and safety practices when wiring this controller to a power source, electrical sensors or peripheral devices. Failure to do so may result in damage to equipment and property, and/or injury or loss of life.

Explosion Hazard - Dry contact closure Digital Inputs shall not be used in Class I Division 2 Hazardous Locations unless switch used is approved for this application.

Explosion Hazard – Substitution of component may impair suitability for CLASS I, DIVISION 2.

Explosion Hazard - Do not disconnect while the circuit is live or unless the area is known to be free of ignitable concentrations of flammable substances.

## Connecting a Digital Output from Zone 2 to a Digital Input of Zone 1

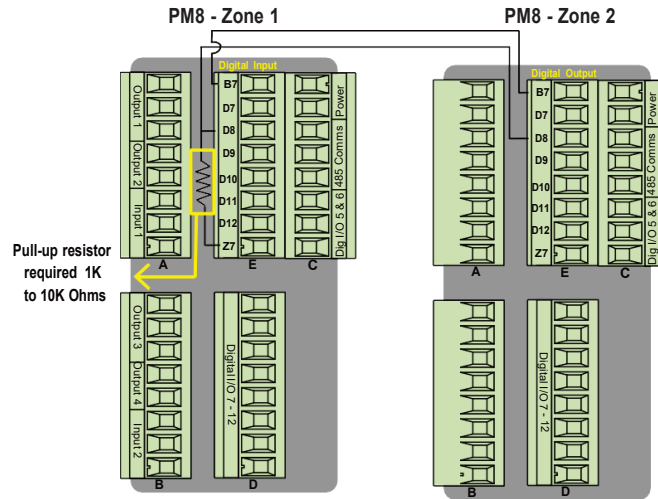

In the example above, digital output D8 from Zone 2 is connected to digital input D8 of Zone 1, configured as a Voltage Input.

### Note:

As shown in the graphic above, for this configuration, a pull-up resistor is required.

## Output 1, 3 Switched DC/Open Collector

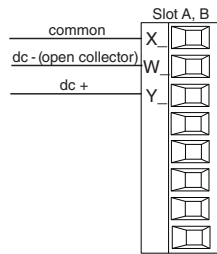

### Switched DC

- Maximum open circuit voltage is 22 to 25VDC
- 30mA max. per single output / 40mA max. total per paired outputs (1 & 2, 3 & 4)
- Typical drive; 4.5V (dc) @ 30mA
- Short circuit limited to <50mA
- NPN transistor sink
- Use dc- and dc+ to drive external solid-state relay
- 1-pole DIN-A-MITE: up to 4 in parallel or 4 in series
- 2-pole DIN-A-MITE: up to 2 in parallel or 2 in series
- 3-pole DIN-A-MITE: up to 2 in series

### Open Collector

- 100mA maximum output current sink
- 30V (dc) max. supply voltage
- Any switched dc output can use the common terminal.
- Use an external power supply to control a dc load, with the load positive to the positive of the power supply, the load negative to the open collector and common to the power supply negative.

### Switched DC

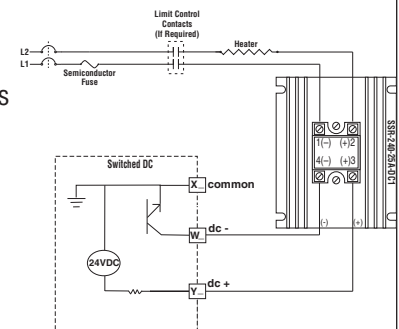

### Open Collector

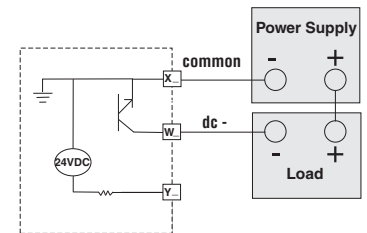

Output 1: (X1,-W1,+Y1)

[PM] --- [C] ---

Output 3: (X3,-W3,+Y3)

[PM] --- [C] ---

## Wiring Notes

Maximum wire size termination and torque rating:

0.0507 to 3.30 mm<sup>2</sup> (30 to 12 AWG) single-wire termination or two 1.31 mm<sup>2</sup> (16 AWG)

0.56 Nm (5.0 in-lb.) torque

Adjacent terminals may be labeled differently depending on the model number.

Do not connect wires to unused terminals.

Maintain electrical isolation between analog input 1, digital input-outputs, switched dc/open collector outputs and process outputs to prevent ground loops.

This equipment is suitable for use in CLASS I, DIVISION 2, Groups A, B, C and D or Non-Hazardous locations only. Temperature Code T4A

## Wiring Warnings

Use National Electric (NEC) or other country-specific standard wiring and safety practices when wiring this controller to a power source, electrical sensors or peripheral devices. Failure to do so may result in damage to equipment and property, and/or injury or loss of life.

Explosion Hazard - Dry contact closure Digital Inputs shall not be used in Class I Division 2 Hazardous Locations unless switch used is approved for this application.

Explosion Hazard - Substitution of component may impair suitability for CLASS I, DIVISION 2.

Explosion Hazard - Do not disconnect while the circuit is live or unless the area is known to be free of ignitable concentrations of flammable substances.

## Output 1, 3 Mechanical Relay, Form C

Output 1: (L1,K1,J1) [PM] \_\_\_ [E] \_ - \_ \_ \_ \_ \_

Output 3: (L3,K3,J3) [PM] \_ \_ \_ \_ \_ [E] \_ \_ \_ \_ \_

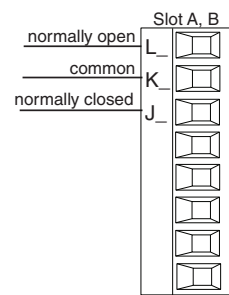

- 5A at 240V $\sim$  (ac) or 30V $\overline{\text{---}}$  (dc) maximum resistive load
- 20mA at 24V minimum load
- 125VA pilot duty at 120/240V $\sim$  (ac), 25VA at 24V $\sim$  (ac)
- 100,000 cycles at rated load
- Output does not supply power.
- For use with ac or dc

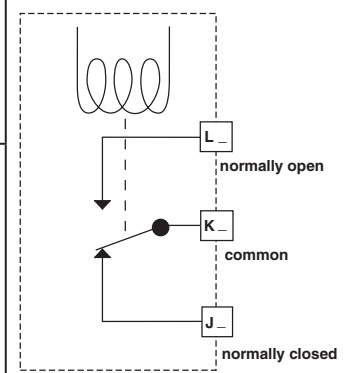

## Output 1, 3 Universal Process

Output 1: (F1,G1,H1) [PM] \_\_\_ [F] \_ - \_ \_ \_ \_ \_

Output 3: (F3,G3,H3) [PM] \_ \_ \_ \_ \_ [F] \_ \_ \_ \_ \_

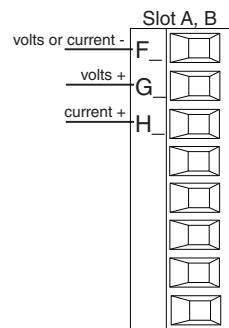

- 0 to 20mA into 800  $\Omega$  maximum load
- 0 to 10V $\overline{\text{---}}$  (dc) into 1 k $\Omega$  minimum load
- Scalable
- Output supplies power
- Cannot use voltage and current outputs at same time
- Output may be used as retransmit or control.

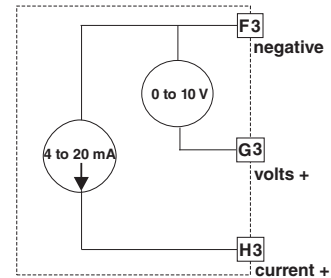

## Output 1, 3 Solid-State Relay, Form A

Output 1: (L1, K1) [PM] \_\_\_ [K] \_ - \_ \_ \_ \_ \_

Output 3: (L3, K3) [PM] \_ \_ \_ \_ \_ [K] \_ \_ \_ \_ \_

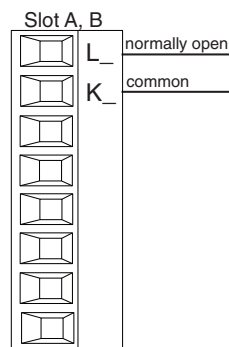

- 0.5A at 20 to 264V $\sim$  (ac) max resistive load
- 20VA 120/240V $\sim$  (ac) pilot duty
- Opto-isolated, without contact suppression
- Maximum off state leakage of 105 $\mu$ A
- Output does not supply power
- Minimum holding current of 10mA
- Do not use on dc loads.
- See Quencharc note

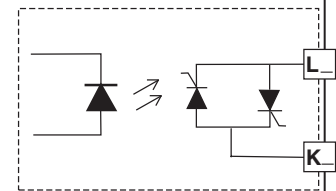

## Wiring Notes

Maximum wire size termination and torque rating:

0.0507 to 3.30 mm<sup>2</sup> (30 to 12 AWG) single-wire termination or two 1.31 mm<sup>2</sup> (16 AWG)

0.56 Nm (5.0 in.-lb.) torque

Adjacent terminals may be labeled differently depending on the model number.

Do not connect wires to unused terminals.

Maintain electrical isolation between analog input 1, digital input-outputs, switched dc/open collector outputs and process outputs to prevent ground loops.

This equipment is suitable for use in CLASS I, DIVISION 2, Groups A, B, C and D or Non-Hazardous locations only. Temperature Code T4A

## Wiring Warnings

Use National Electric (NEC) or other country-specific standard wiring and safety practices when wiring this controller to a power source, electrical sensors or peripheral devices. Failure to do so may result in damage to equipment and property, and/or injury or loss of life.

**Explosion Hazard - Dry contact closure** Digital Inputs shall not be used in Class I Division 2 Hazardous Locations unless switch used is approved for this application.

**Explosion Hazard - Substitution of component** may impair suitability for CLASS I, DIVISION 2.

**Explosion Hazard - Do not disconnect** while the circuit is live or unless the area is known to be free of ignitable concentrations of flammable substances.

## Output 2, 4 Switched DC

Output 2: (-W2, +Y2) [PM] \_\_\_\_\_ [C] - \_\_\_\_\_

Output 4: (-W4, +Y4) [PM] \_\_\_\_\_ [C] \_\_\_\_\_

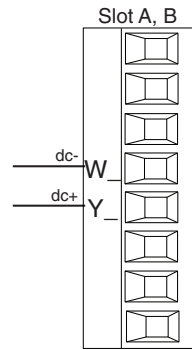

- Maximum open circuit voltage 22 to 25V $\overline{\text{dc}}$
- 30mA max. per single output / 40mA max. total per paired outputs (1 & 2, 3 & 4)
- Typical drive; 4.5V $\overline{\text{dc}}$  @ 30mA
- Short circuit limited to <50mA
- NPN transistor sink
- Use dc- and dc+ to drive external solid-state relay
- 1-pole DIN-A-MITE: up to 4 in parallel or 4 in series
- 2-pole DIN-A-MITE: up to 2 in parallel or 2 in series
- 3-pole DIN-A-MITE: up to 2 in series

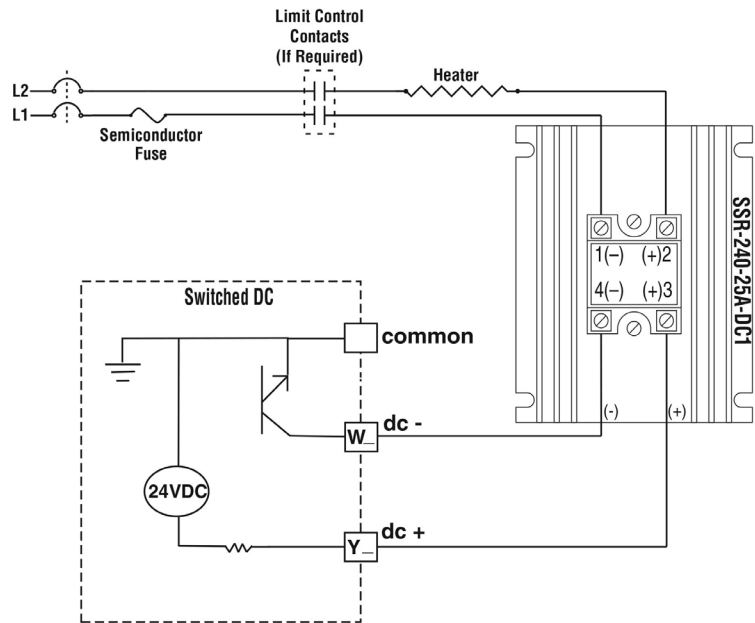

## Output 2, NO-ARC Relay, Form A

Output 2: (L2, K2) [PM] \_\_\_\_\_ [H] - \_\_\_\_\_

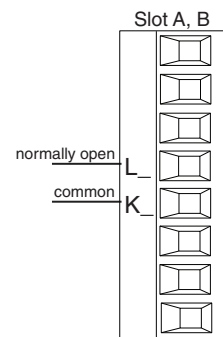

- 12A at 85 to 264V $\sim$  (ac) resistive load only
- 2,000,000 cycle rating for NO-ARC circuit
- 100mA minimum load
- 2mA maximum off state leakage
- Do not use on dc loads
- Output does not supply power

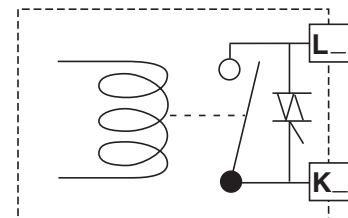

## Wiring Notes

Maximum wire size termination and torque rating:

0.0507 to 3.30 mm<sup>2</sup> (30 to 12 AWG) single-wire termination or two 1.31 mm<sup>2</sup> (16 AWG)

0.56 Nm (5.0 in-lb.) torque

Adjacent terminals may be labeled differently depending on the model number.

Do not connect wires to unused terminals.

Maintain electrical isolation between analog input 1, digital input-outputs, switched dc/open collector outputs and process outputs to prevent ground loops.

This equipment is suitable for use in CLASS I, DIVISION 2, Groups A, B, C and D or Non-Hazardous locations only. Temperature Code T4A

## Wiring Warnings

Use National Electric (NEC) or other country-specific standard wiring and safety practices when wiring this controller to a power source, electrical sensors or peripheral devices. Failure to do so may result in damage to equipment and property, and/or injury or loss of life.

Explosion Hazard - Dry contact closure Digital Inputs shall not be used in Class I Division 2 Hazardous Locations unless switch used is approved for this application.

Explosion Hazard – Substitution of component may impair suitability for CLASS I, DIVISION 2.

Explosion Hazard - Do not disconnect while the circuit is live or unless the area is known to be free of ignitable concentrations of flammable substances.

## Output 2, 4 Mechanical Relay, Form A

Output 2: (L2, K2) [PM] \_\_\_\_\_ [J] - \_\_\_\_\_

Output 4: (L4, K4) [PM] \_\_\_\_\_ - \_\_\_\_\_ [J] \_\_\_\_\_

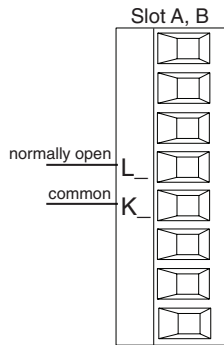

- 5A at 240V $\sim$  (ac) or 30V $\text{---}$  (dc) maximum resistive load
- 20mA at 24V minimum load
- 125VA pilot duty @ 120/240V $\sim$  (ac), 25VA at 24V $\sim$  (ac)
- 100,000 cycles at rated load
- Output does not supply power
- For use with ac or dc
- See Quencharc Wiring Example

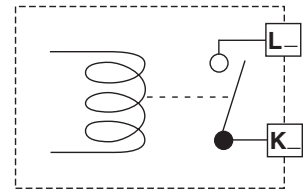

## Output 2, 4 Solid-State Relay, Form A

Output 2: (L2, K2) [PM] \_\_\_\_\_ [K] - \_\_\_\_\_

Output 4: (L4, K4) [PM] \_\_\_\_\_ - \_\_\_\_\_ [K] \_\_\_\_\_

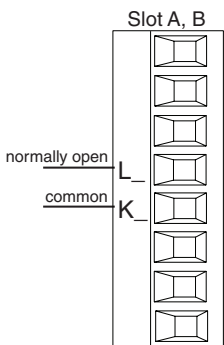

- 0.5A at 20 to 264V $\sim$  (ac) maximum resistive load
- 20VA 120/240V $\sim$  (ac) pilot duty
- Opto-isolated, without contact suppression
- Maximum off state leakage of 105 $\mu$ A
- Minimum holding current of 10mA
- Output does not supply power
- Do not use on dc loads.
- See Quencharc Wiring Example

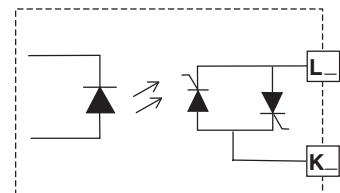

## Quencharc Wiring Example

In this example the Quencharc circuit (Watlow part# 0804-0147-0000) is used to protect PM internal circuitry from the counter electromagnetic force from the inductive user load when de-energized. It is recommended that this or an equivalent Quencharc be used when connecting inductive loads to PM outputs.

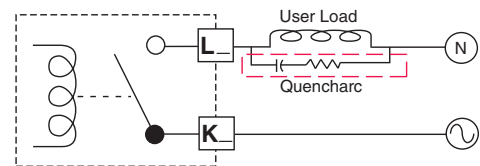



## Wiring Notes

Maximum wire size termination and torque rating:

0.0507 to 3.30 mm<sup>2</sup> (30 to 12 AWG) single-wire termination or two 1.31 mm<sup>2</sup> (16 AWG)

0.56 Nm (5.0 in.-lb.) torque

Adjacent terminals may be labeled differently depending on the model number.

Do not connect wires to unused terminals.

Maintain electrical isolation between analog input 1, digital input-outputs, switched dc/open collector outputs and process outputs to prevent ground loops.

This equipment is suitable for use in CLASS I, DIVISION 2, Groups A, B, C and D or Non-Hazardous locations only. Temperature Code T4A

## Wiring Warnings

Use National Electric (NEC) or other country-specific standard wiring and safety practices when wiring this controller to a power source, electrical sensors or peripheral devices. Failure to do so may result in damage to equipment and property, and/or injury or loss of life.

Explosion Hazard - Dry contact closure Digital Inputs shall not be used in Class I Division 2 Hazardous Locations unless switch used is approved for this application.

Explosion Hazard – Substitution of component may impair suitability for CLASS I, DIVISION 2.

Explosion Hazard - Do not disconnect while the circuit is live or unless the area is known to be free of ignitable concentrations of flammable substances.

## Standard Bus EIA-485 Communications

[PM] \_\_\_\_\_ - [\*] \_\_\_\_\_

\*All models include Standard Bus communications (instance 1)

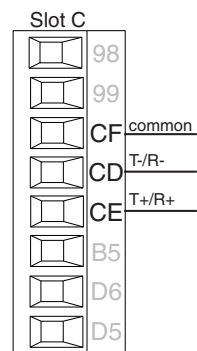

- Wire T-/R- to the A terminal of the EIA-485 port.
- Wire T+/R+ to the B terminal of the EIA-485 port.
- Wire common to the common terminal of the EIA-485 port.
- Do not route network wires with power wires. Connect network wires in daisy-chain fashion when connecting multiple devices in a network.
- Do not connect more than 16 controllers on a network.
- Maximum network length: 1,200 meters (4,000 feet)
- 1/8th unit load on EIA-485 bus

Note: Do not leave a USB to EIA-485 converter connected to Standard Bus without power (i.e., disconnecting the USB end from the PC and leave the converter connected on Standard Bus). Disturbance on the Standard Bus may occur.

## Modbus® RTU or Standard Bus EIA-485 Communications

[PM] \_\_\_\_\_ - [1] \_\_\_\_\_

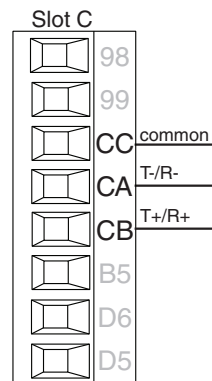

- Wire T-/R- to the A terminal of the EIA-485 port.
- Wire T+/R+ to the B terminal of the EIA-485 port.
- Wire common to the common terminal of the EIA-485 port.
- Do not route network wires with power wires. Connect network wires in daisy-chain fashion when connecting multiple devices in a network.
- A termination resistor may be required. Place a 120 Ω resistor across T+/R+ and T-/R- of last controller on network.
- Only one protocol per port is available at a time: either Modbus® RTU or Standard Bus.
- Do not connect more than 16 controllers on a Standard Bus network.
- Maximum number of controllers on a Modbus® network is 247.
- Maximum network length: 1,200 meters (4,000 feet)
- 1/8th unit load on EIA-485 bus.
- Communications instance 1

Note: Do not leave a USB to EIA-485 converter connected to Standard Bus without power (i.e., disconnecting the USB end from the computer while leaving the converter connected on Standard Bus). Disturbance on the Standard Bus may occur.

## Wiring Notes

Maximum wire size termination and torque rating:

0.0507 to 3.30 mm<sup>2</sup> (30 to 12 AWG) single-wire termination or two 1.31 mm<sup>2</sup> (16 AWG)

0.56 Nm (5.0 in-lb.) torque

Adjacent terminals may be labeled differently depending on the model number.

Do not connect wires to unused terminals.

Maintain electrical isolation between analog input 1, digital input-outputs, switched dc/open collector outputs and process outputs to prevent ground loops.

This equipment is suitable for use in CLASS I, DIVISION 2, Groups A, B, C and D or Non-Hazardous locations only. Temperature Code T4A

## Wiring Warnings

Use National Electric (NEC) or other country-specific standard wiring and safety practices when wiring this controller to a power source, electrical sensors or peripheral devices. Failure to do so may result in damage to equipment and property, and/or injury or loss of life.

Explosion Hazard - Dry contact closure Digital Inputs shall not be used in Class I Division 2 Hazardous Locations unless switch used is approved for this application.

Explosion Hazard - Substitution of component may impair suitability for CLASS I, DIVISION 2.

Explosion Hazard - Do not disconnect while the circuit is live or unless the area is known to be free of ignitable concentrations of flammable substances.

## EIA-232/485 Modbus® RTU Communications

[PM] \_ \_ \_ \_ - [2] \_ \_ \_ \_ \_

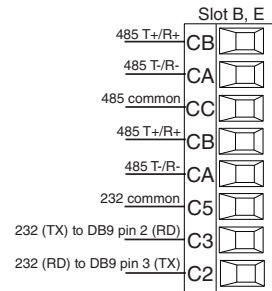

- Wire T-/R- to the A terminal of the EIA-485 port.
- Wire T+/R+ to the B terminal of the EIA-485 port.
- Wire common to the common terminal of the EIA-485 port.
- Do not route network wires with power wires. Connect network wires in daisy-chain fashion when connecting multiple devices in a network.
- A termination resistor may be required. Place a 120 Ω resistor across T+/R+ and T-/R- of last controller on network.
- Do not wire to both the EIA-485 and the EIA-232 pins at the same time.
- Two EIA-485 terminals of T/R are provided to assist in daisy-chain wiring.
- Do not connect more than one controller on an EIA-232 network.
- Maximum number of controllers on a Modbus® network is 247.
- Maximum EIA-232 network length: 15 meters (50 feet)
- Maximum EIA-485 network length: 1,200 meters (4,000 feet)
- 1/8th unit load on EIA-485 bus.
- Communications instance 2

Modbus®-IDA Terminal	EIA/TIA-485 Name	Watlow Terminal Label	Function
D0	A	CA or CD	T-/R-
D1	B	CB or CE	T+/R+
common	common	CC or CF	common

## EtherNet/IP™, PCCC, and Modbus® TCP Communications (Instance 2)

[PM] \_ \_ \_ \_ - [3] \_ \_ \_ \_ \_

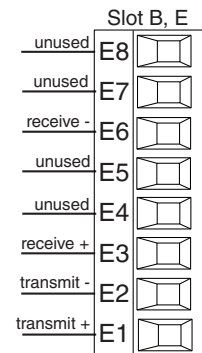

RJ-45 pin	T568B wire color	Signal	Slot B
8	brown	unused	E8
7	brown & white	unused	E7
6	green	receive -	E6
5	white & blue	unused	E5
4	blue	unused	E4
3	white & green	receive +	E3
2	orange	transmit -	E2
1	white & orange	transmit +	E1

- Do not route network wires with power wires.
- Connect one Ethernet cable per controller to a 10/100 Mbps Ethernet switch. Both Modbus® TCP and EtherNet/IP™ are available on the network.
- When using Modbus® TCP, the Network Status and Module Status LEDs are not used.

## Wiring Notes

Maximum wire size termination and torque rating:

0.0507 to 3.30 mm<sup>2</sup> (30 to 12 AWG) single-wire termination or two 1.31 mm<sup>2</sup> (16 AWG)

0.56 Nm (5.0 in.-lb.) torque

Adjacent terminals may be labeled differently depending on the model number.

Do not connect wires to unused terminals.

Maintain electrical isolation between analog input 1, digital input-outputs, switched dc/ open collector outputs and process outputs to prevent ground loops.

This equipment is suitable for use in CLASS I, DIVISION 2, Groups A, B, C and D or Non-Hazardous locations only. Temperature Code T4A

## Wiring Warnings

Use National Electric (NEC) or other country-specific standard wiring and safety practices when wiring this controller to a power source, electrical sensors or peripheral devices. Failure to do so may result in damage to equipment and property, and/or injury or loss of life.

Explosion Hazard - Dry contact closure Digital Inputs shall not be used in Class I Division 2 Hazardous Locations unless switch used is approved for this application.

Explosion Hazard – Substitution of component may impair suitability for CLASS I, DIVISION 2.

Explosion Hazard - Do not disconnect while the circuit is live or unless the area is known to be free of ignitable concentrations of flammable substances.

## EtherNet/IP™, PCCC, and Modbus® TCP Communications (Instance 2) continued

**Note:** When changing the fixed IP address, cycle module power for new address to take effect.

### Ethernet LED Indicators

Viewing the control from the front and then looking on top four LEDs can be seen aligned vertically front to back. The LEDs are identified accordingly: closest to the front reflects the Network (Net) Status, Module (Mod) Status is next, Activity status follows and lastly, the LED closest to the rear of the control reflects the Link status.

**Note:** When using Modbus TCP, the Network Status and Module Status LEDs are not used.

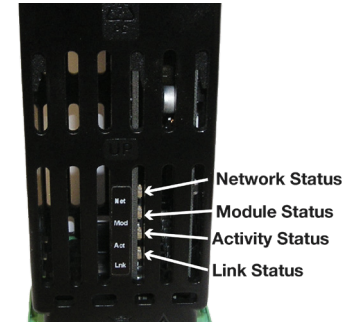

Network Status Indicator (LED closest to the front)		
Indicator State	Summary	Requirement
Steady Off	Not powered, no IP address	The device does not have an IP address (or is powered off).
Flashing Green	No connections	The device has no established connections, but has obtained an IP address.
Steady Green	Connected	The device has at least one established connection (even to the Message Router).
Flashing Red	Connection timeout	One or more connections in which this device is the target timed out. This clears only if all timed out connections are reestablished or if the device is reset.
Steady Red	Duplicate IP	The device detects that its IP address is already in use.
Flashing Green / Red	Self-test	The device is performing its power up testing.
Module Status Indicator (2nd from the front)		
Indicator State	Summary	Requirement
Steady Off	No power	No power is supplied to the device.
Steady Green	Operational	The device is operating correctly.
Flashing Green	Standby	If the device has not been configured, this LED flashes green.
Flashing Red	Minor fault	The device detects a recoverable minor fault. NOTE: An incorrect or inconsistent configuration is considered a minor fault.
Steady Red	Major fault	The device detects a non-recoverable major fault.
Flashing Green / Red	Self-test	While the device is performing power up testing.
Activity Status Indicator (3rd from front)		
Indicator State	Summary	Requirement
Flashing Green	Detects activity	MAC detects activity
Red	---	MAC detects a collision.
Link Status Indicator (Last LED, near rear of the device)		
Indicator State	Summary	Requirement
Steady Off	Not powered, unknown link speed	Device cannot determine link speed or power is off.
Green	---	Cable is wired and connected correctly.

## Wiring Notes

Maximum wire size termination and torque rating:

0.0507 to 3.30 mm<sup>2</sup> (30 to 12 AWG) single-wire termination or two 1.31 mm<sup>2</sup> (16 AWG)

0.56 Nm (5.0 in-lb.) torque

Adjacent terminals may be labeled differently depending on the model number.

Do not connect wires to unused terminals.

Maintain electrical isolation between analog input 1, digital input-outputs, switched dc/open collector outputs and process outputs to prevent ground loops.

This equipment is suitable for use in CLASS I, DIVISION 2, Groups A, B, C and D or Non-Hazardous locations only. Temperature Code T4A

## Wiring Warnings

Use National Electric (NEC) or other country-specific standard wiring and safety practices when wiring this controller to a power source, electrical sensors or peripheral devices. Failure to do so may result in damage to equipment and property, and/or injury or loss of life.

Explosion Hazard - Dry contact closure Digital Inputs shall not be used in Class I Division 2 Hazardous Locations unless switch used is approved for this application.

Explosion Hazard – Substitution of component may impair suitability for CLASS I, DIVISION 2.

Explosion Hazard - Do not disconnect while the circuit is live or unless the area is known to be free of ignitable concentrations of flammable substances.

## DeviceNet™ Communications (Instance 2)

([PM] \_\_\_\_\_ - [5] \_\_\_\_\_ )

Slot B, E	Terminal	Signal	Function
V+	V+	V+	DeviceNet™ power
CAN_H	CH	CAN_H	positive side of DeviceNet™ bus
shield	SH	shield	shield interconnect
CAN_L	CL	CAN_L	negative side of DeviceNet™ bus
V-	V-	V-	DeviceNet™ power return

## DeviceNet LED Indicators

Viewing the control from the front and then looking on top two LEDs can be seen aligned vertically front to back. The LED closest to the front is identified as the network (Net) LED where the one next to it would be identified as the module (Mod) LED.

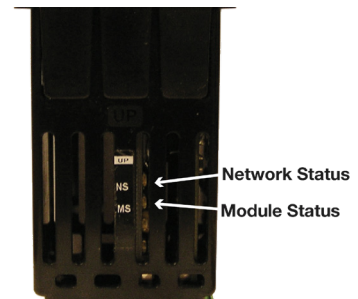

## Wiring Notes

Maximum wire size termination and torque rating:

0.0507 to 3.30 mm<sup>2</sup> (30 to 12 AWG) single-wire termination or two 1.31 mm<sup>2</sup> (16 AWG)

0.56 Nm (5.0 in.-lb.) torque

Adjacent terminals may be labeled differently depending on the model number.

Do not connect wires to unused terminals.

Maintain electrical isolation between analog input 1, digital input-outputs, switched dc/open collector outputs and process outputs to prevent ground loops.

This equipment is suitable for use in CLASS I, DIVISION 2, Groups A, B, C and D or Non-Hazardous locations only. Temperature Code T4A

## Wiring Warnings

Use National Electric (NEC) or other country-specific standard wiring and safety practices when wiring this controller to a power source, electrical sensors or peripheral devices. Failure to do so may result in damage to equipment and property, and/or injury or loss of life.

Explosion Hazard - Dry contact closure Digital Inputs shall not be used in Class I Division 2 Hazardous Locations unless switch used is approved for this application.

Explosion Hazard – Substitution of component may impair suitability for CLASS I, DIVISION 2.

Explosion Hazard - Do not disconnect while the circuit is live or unless the area is known to be free of ignitable concentrations of flammable substances.

DeviceNet Network Status LED Indicator (LED closest to the front of the device)	
Indicator LED	Description
Off	The device is not online and has not completed the duplicate MAC ID test yet. The device may not be powered.
Green	The device is online and has connections in the established state (allocated to a Master).
Red	Failed communication device. The device has detected an error that has rendered it incapable of communicating on the network (duplicate MAC ID or Bus-off).
Flashing Green	The device is online, but no connection has been allocated or an explicit connection has timed out.
Flashing Red	A poll connection has timed out.

DeviceNet Module Status LED Indicator (Located next to the Network Status LED)	
Indicator LED	Description
Off	No power is applied to the device.
Flashing Green-Red	The device is performing a self-test.
Flashing Red	Major Recoverable Fault.
Red	Major Unrecoverable Fault.
Green	The device is operating normally.

## J1939 CAN bus Communications (Instance 2)

([PM] \_\_\_\_\_ - [7] \_\_\_\_\_)

	Terminal	Signal	Function
CAN_L	CL	CAN_L	negative side of CAN bus
CAN_H	CH	CAN_H	positive side of CAN bus
Shield	SH	shield	shield interconnect
Volts +	V+	V+	CAN bus power
Volts -	V-	V-	CAN bus power return

J1939 LED Indicators	
Viewing the control from the rear top, two LEDs are aligned vertically front to back. The LED closest to the front is identified as CAN 2 (channel 2, currently not used) and the one closest to the connector is identified as CAN 1 (channel 1).	
CAN 1 Indicator LED	Description
Off	CAN communications with J1939 Card inactive.
Flashing Red	New CAN frame transmission occurred.
Flashing Green	CAN communications active with J1939 Card.

## Wiring Notes

Maximum wire size termination and torque rating:

0.0507 to 3.30 mm<sup>2</sup> (30 to 12 AWG) single-wire termination or two 1.31 mm<sup>2</sup> (16 AWG)

0.56 Nm (5.0 in-lb.) torque

Adjacent terminals may be labeled differently depending on the model number.

Do not connect wires to unused terminals.

Maintain electrical isolation between analog input 1, digital input-outputs, switched dc/open collector outputs and process outputs to prevent ground loops.

This equipment is suitable for use in CLASS I, DIVISION 2, Groups A, B, C and D or Non-Hazardous locations only. Temperature Code T4A

## Wiring Warnings

Use National Electric (NEC) or other country-specific standard wiring and safety practices when wiring this controller to a power source, electrical sensors or peripheral devices. Failure to do so may result in damage to equipment and property, and/or injury or loss of life.

Explosion Hazard - Dry contact closure Digital Inputs shall not be used in Class I Division 2 Hazardous Locations unless switch used is approved for this application.

Explosion Hazard – Substitution of component may impair suitability for CLASS I, DIVISION 2.

Explosion Hazard - Do not disconnect while the circuit is live or unless the area is known to be free of ignitable concentrations of flammable substances.

## Profibus DP Communications

[PM] \_ \_ \_ \_ -[6] \_ \_ \_ \_ \_

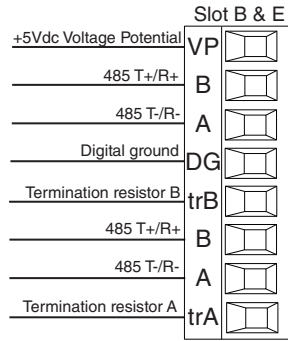

- Wire T-/R- to the A terminal of the EIA-485 port.
- Wire T+/R+ to the B terminal of the EIA-485 port.
- Wire Digital Ground to the common terminal of the EIA-485 port.
- Do not route network wires with power wires. Connect network wires in daisy-chain fashion when connecting multiple devices.
- A termination resistor should be used if this is the last control on the network.
- If using a 150 Ω cable Watlow provides internal termination. Place a jumper across pins trB and B and trA and A.
- If external termination is to be used with a 150 Ω cable place a 390 Ω resistor across pins VP and B, a 220 Ω resistor across pins B and A, and lastly, place a 390 Ω resistor across pins DG and A.
- Do not connect more than 32 controllers on a segment.
- Maximum EIA-485 network length: 1,200 meters (4,000 feet)
- 1/8th unit load on EIA-485 bus
- When termination jumpers are in place, there is 392 ohm pull up resistor to 5V and 392 ohm pull down resistor to DG. There is also a 221 ohm resistor between A and B.
- Communications instance 2

Profibus Terminal	EIA/TIA-485 Name	Watlow Terminal Label	Function
VP (Voltage Potential)	---	VP	+5Vdc
B-Line	B	B	T+/R+
A-Line	A	A	T-/R-
DP-GND	common	DG	common

## Profibus DP LED Indicators

Viewing the unit from the front and then looking on top of the controller two bi-color LEDs can be seen where only the front one is used. Definition follows:

Indicator LED	Description
Red	Profibus network not detected
Red Flashing	Indicates that the Profibus card is waiting for data exchange.
Green	Data exchange mode

### Wiring Notes

Maximum wire size termination and torque rating:

0.0507 to 3.30 mm<sup>2</sup> (30 to 12 AWG) single-wire termination or two 1.31 mm<sup>2</sup> (16 AWG)

0.56 Nm (5.0 in-lb.) torque

Adjacent terminals may be labeled differently depending on the model number.

Do not connect wires to unused terminals.

Maintain electrical isolation between analog input 1, digital input-outputs, switched dc/open collector outputs and process outputs to prevent ground loops.

This equipment is suitable for use in CLASS I, DIVISION 2, Groups A, B, C and D or Non-Hazardous locations only. Temperature Code T4A

### Wiring Warnings

Use National Electric (NEC) or other country-specific standard wiring and safety practices when wiring this controller to a power source, electrical sensors or peripheral devices. Failure to do so may result in damage to equipment and property, and/or injury or loss of life.

Explosion Hazard - Dry contact closure Digital Inputs shall not be used in Class I Division 2 Hazardous Locations unless switch used is approved for this application.

Explosion Hazard – Substitution of component may impair suitability for CLASS I, DIVISION 2.

Explosion Hazard - Do not disconnect while the circuit is live or unless the area is known to be free of ignitable concentrations of flammable substances.

## Wiring a Serial EIA-485 Network

Do not route network wires with power wires. Connect network wires in daisy-chain fashion when connecting multiple devices in a network. A termination resistor may be required. Place a 120 Ω resistor across T+/R+ and T-/R- of the last controller on a network.

Only one protocol per port is available at a time: either Modbus® RTU or Standard Bus.

### A Network Using Watlow's Standard Bus and an RUI/Gateway

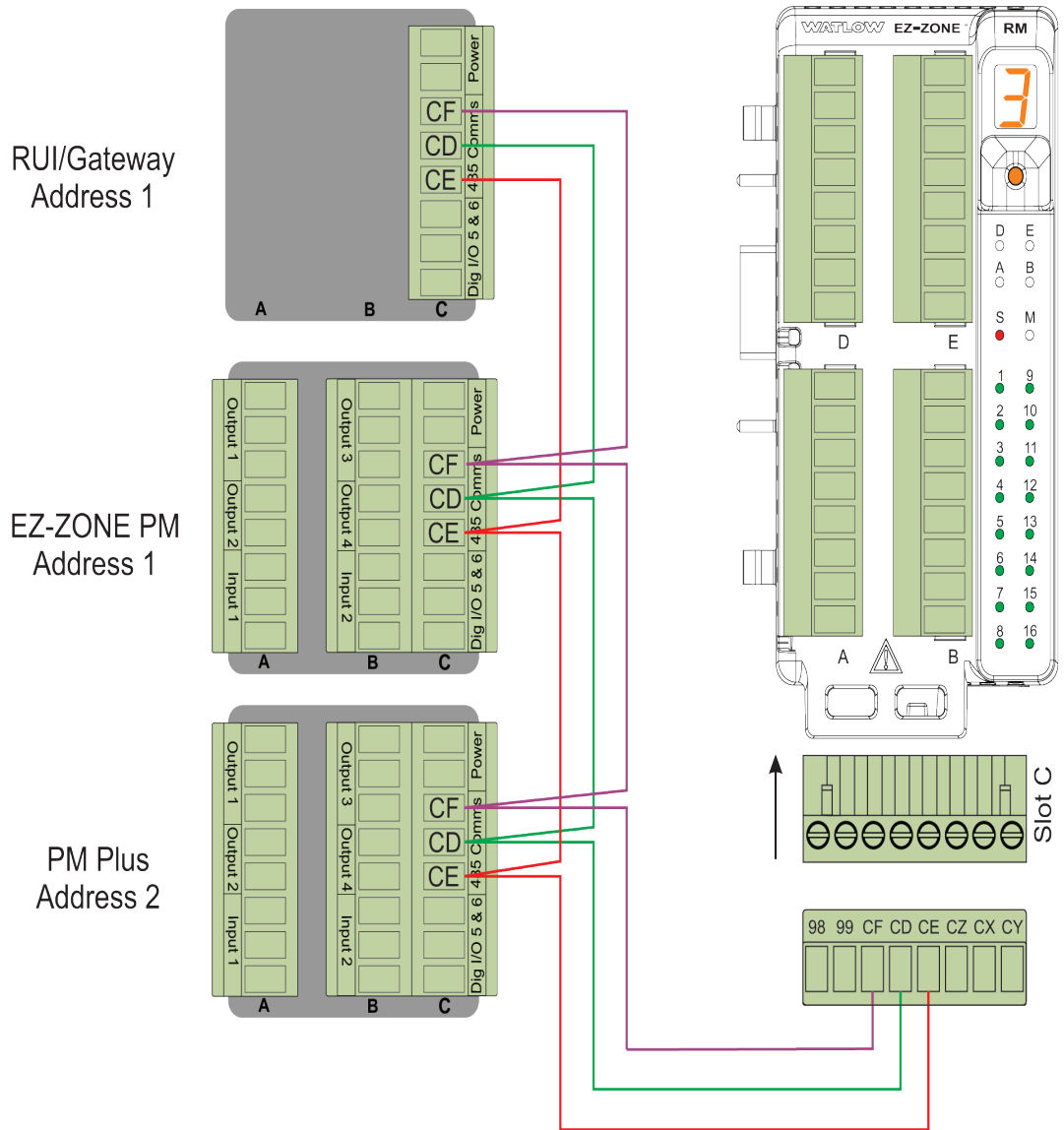

## Wiring Notes

Maximum wire size termination and torque rating:

0.0507 to 3.30 mm<sup>2</sup> (30 to 12 AWG) single-wire termination or two 1.31 mm<sup>2</sup> (16 AWG)

0.56 Nm (5.0 in.-lb.) torque

Adjacent terminals may be labeled differently depending on the model number.

Do not connect wires to unused terminals.

Maintain electrical isolation between analog input 1, digital input-outputs, switched dc/open collector outputs and process outputs to prevent ground loops.

This equipment is suitable for use in CLASS I, DIVISION 2, Groups A, B, C and D or Non-Hazardous locations only. Temperature Code T4A

## Wiring Warnings

Use National Electric (NEC) or other country-specific standard wiring and safety practices when wiring this controller to a power source, electrical sensors or peripheral devices. Failure to do so may result in damage to equipment and property, and/or injury or loss of life.

Explosion Hazard - Dry contact closure Digital Inputs shall not be used in Class I Division 2 Hazardous Locations unless switch used is approved for this application.

Explosion Hazard – Substitution of component may impair suitability for CLASS I, DIVISION 2.

Explosion Hazard - Do not disconnect while the circuit is live or unless the area is known to be free of ignitable concentrations of flammable substances.

## A Network of Devices Configured Using Modbus® RTU

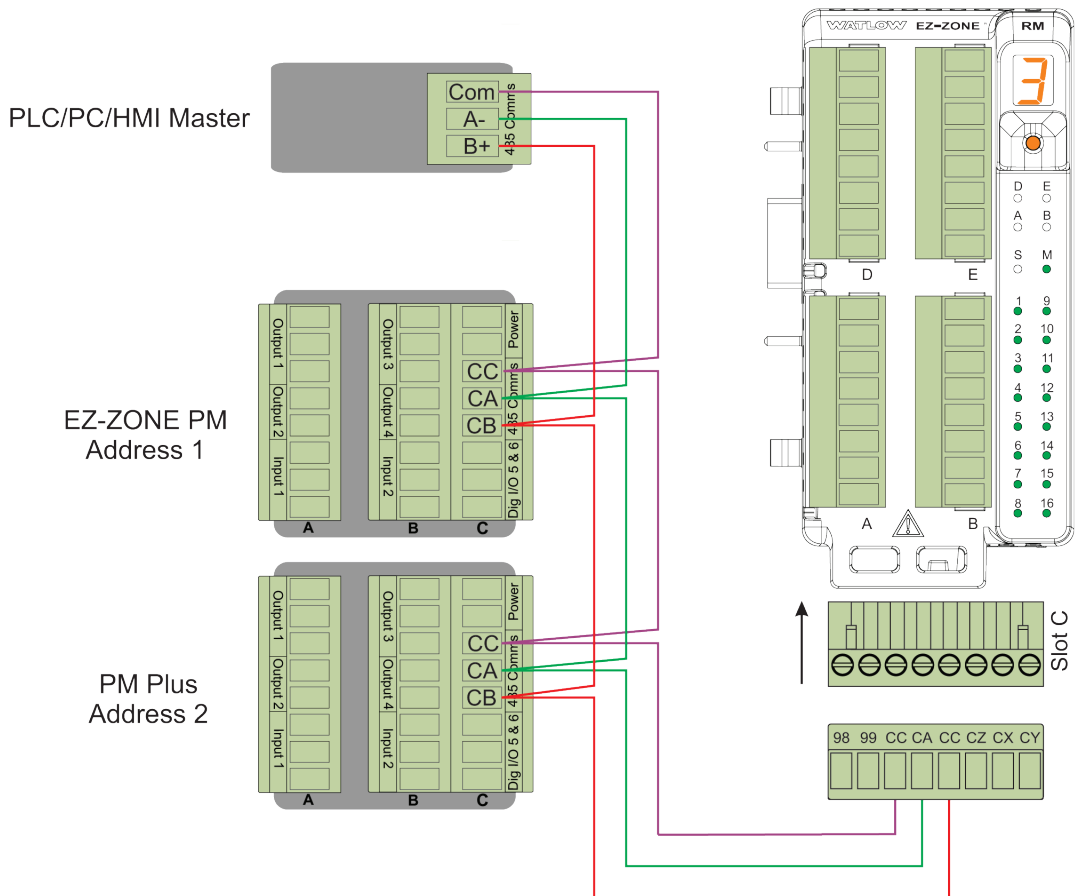



## Connecting PM PLUS™ to a PC Using B&B 485 to USB Converter

Do not leave a USB to EIA-485 converter connected to Standard Bus without power (i.e., disconnecting the USB from the computer with the converter connected on Standard Bus).





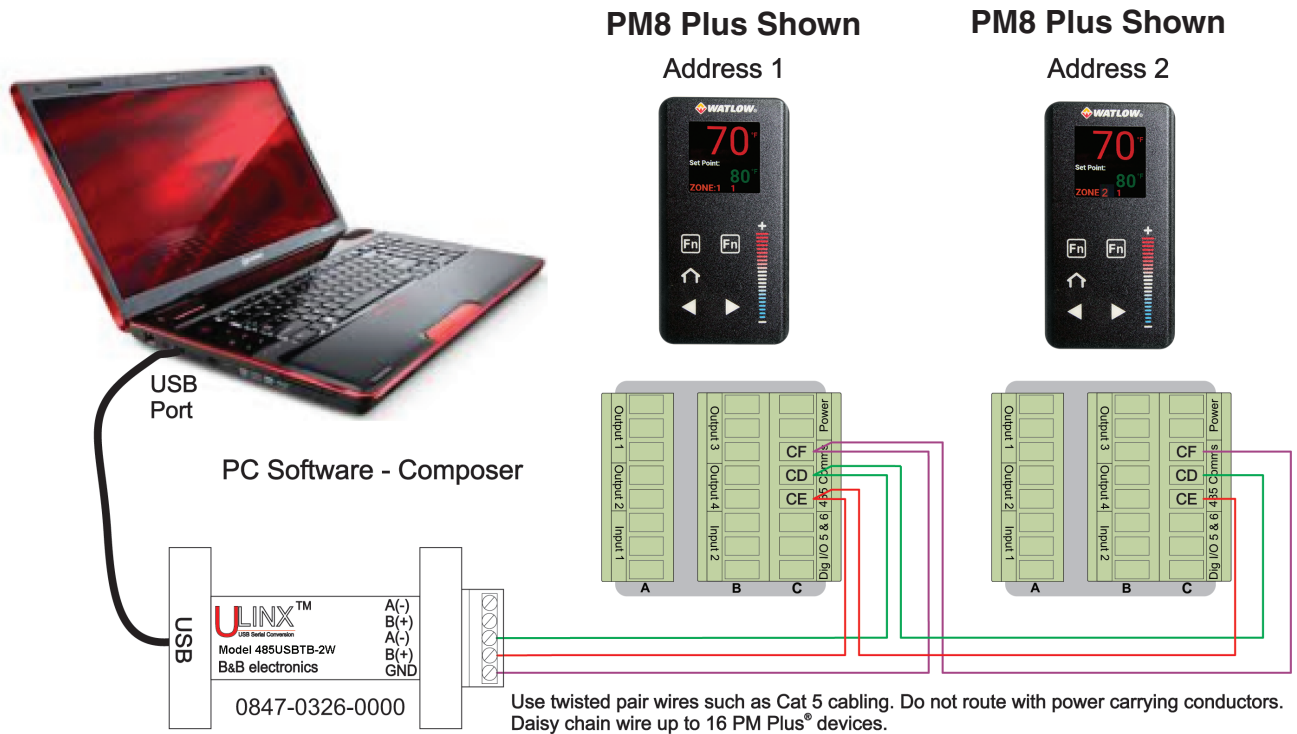

If you connect a USB converter to your PC we recommend that you change the Latency Timer from the default 16 msec to 1 msec. Go to Device Manager, double-click Port; right-click the USB serial port; select Properties; click the Port Settings tab; click the Advanced button, then change the Latency Timer to 1.

Failure to make this change may cause communication loss between the PC running EZ-ZONE Configurator and the control.



# Chapter 3: User Interface

## Touch Keys

-  **A**-Up/Down Increment Key: Scroll up or down lists using the + or - keys.
-  **B**-Numeric Slider: Increase or decrease numeric parameters with the slider.
-  **C**-Forward Select Arrow: Return to the previous selection with the Forward arrow.
-  **D**-Back Select Arrow: Select items or move to lists using the Back arrow.
-  **E**-Home: Return to the home screen from any screen with the Home Key.
-  **F**-Function Keys: Function Keys can be programmed for various tasks.

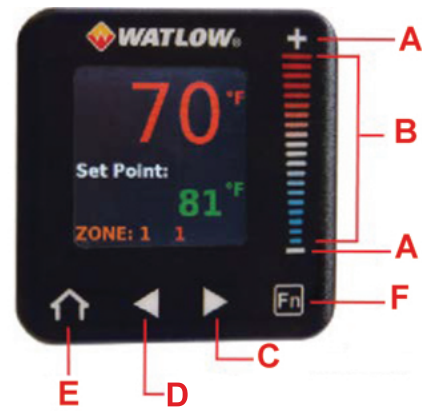

PM6 Plus

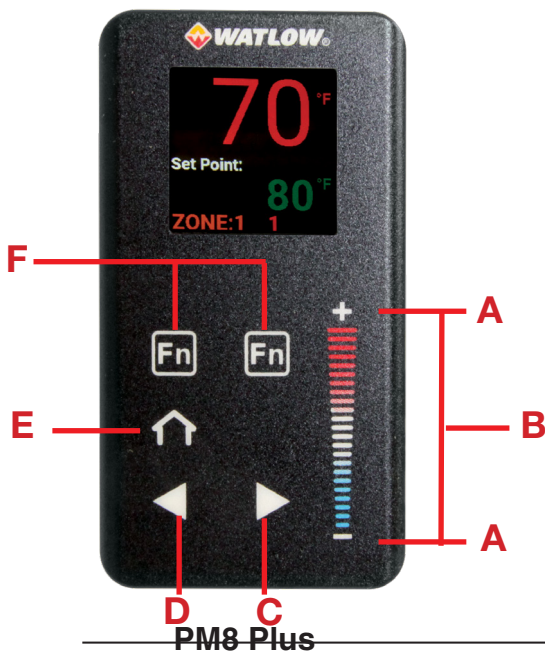

PM8 Plus



PM9 Plus

# Home Screen

The home screen provides a shortcut to monitor or change the parameter values that you use most often. When a parameter from the Setup List or Operations List is displayed on the Home Screen, you can adjust that parameter's value in either place, using the numeric slider or +/- keys on the front of the device.

## Default Home Screen Parameters

By default, the home screen display shows the **Process Value, the Set Point, and the Zone** being read. The upper display is the process value, or the value of the parameter indicated in the lower display. The lower display shows the set point or manual power value, or the parameter for the value showing in the upper display. If Control Mode is Auto, the Process Value and Set Point (read-write) are displayed.

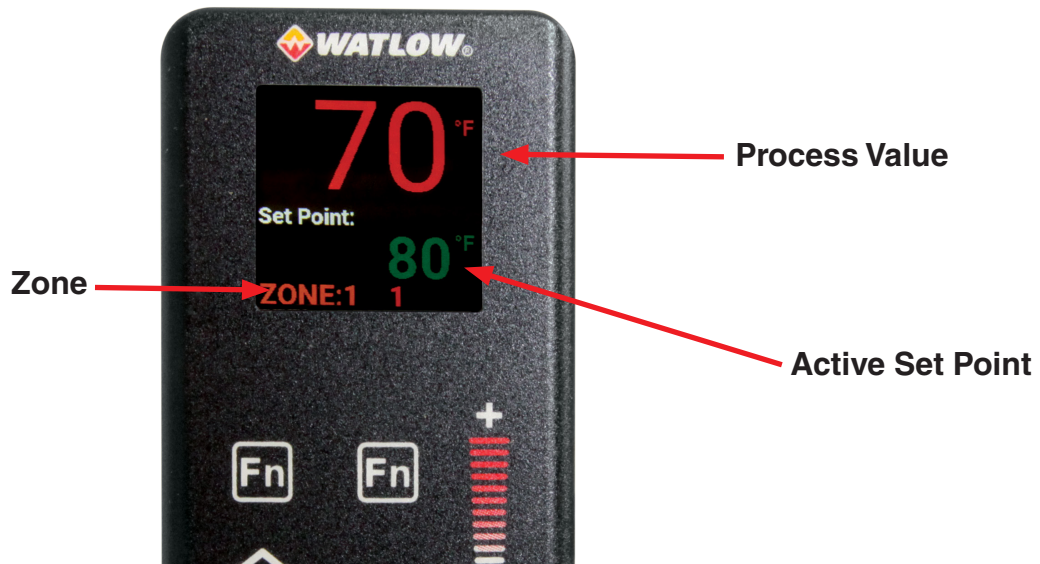

**Home Screen Display (PM8 PLUS Shown)**

If a profile is running, the Process Value and Active Set Point (read only) are displayed.  
If Control Mode is Manual, Process Value and Output Power Level (read-write) are displayed.  
If Control Mode is set to Off, the Process Value is displayed with off (read only).  
If a sensor failure has occurred, dashes ---- are displayed with the Manual Power (read-write).

---

# Active Messages on the Home Screen

An active message will display on the front of the device and toggle between the normal Home Screen display and the active message. Some messages indicate an error, and some are simply informational and indicate that a process is underway.

- Alarm Low 1 to 4
- Alarm High 1 to 4
- Alarm Error 1 to 4
- Error Input 1 or 2
- Limit Low 1
- Limit High 1
- Limit Error 1
- Tuning 1 or 2
- Ramping 1 or 2
- Loop Open Error 1 or 2
- Loop Reversed Error 1 or 2
- Current Error
- Heater Error
- vAL.H - Value to be displayed in 4 digit display > 9999
- vAL.L - Value to be displayed in 4 digit display <-1999

## Responding to Active Messages

If the message was generated by a latched alarm or limit condition, the message can be cleared only when the condition no longer exists. Press the forward arrow to display **Ignore** and the message source (such as **Limit High**). Use the slider or the +/- keys to scroll through possible responses, such as **Clear** or **Silence**, then push the forward arrow key to execute the action.

## Home Screen Themes

You may select another home screen theme to see a different color format and/or to see the output percentage in addition to process value and set point.

1. **Operations — Setup — Global — Home Screen**
2. Select the preferred theme:
  - 0 (Default) = Black background; colored letters
  - 1 = White background; colored letters
  - 2 = Black background; colored letters; includes output power %, next to set point, (bullseye)
  - 3 (High Contrast) = Blue background; white letters; includes output power %, next to set point, (bullseye)

# Chapter 4: Operations

All parameters and lists of options are accessed via the **Operations** List.

Parameters directly in the Operations List are generally used for operations and monitoring. (Additional parameters are located in the Setup, Factory, Profile, and Global Lists, which you can access via **Operations**). The Operations List includes:

- Default parameters/sublists that vary depending on the features enabled on your device, as indicated on the configuration code.
- Custom parameters that you have added via **Operations — Factory — Custom Setup** (See "Adding Custom Parameters to the Operations List.")
- Setup List
- Profile Status and Profile Lists (if enabled on your device)
- Factory List

If you choose to use Modbus® or another communication protocol to write to the PM PLUS, you will need the parameter IDs. For details about fieldbus addresses and Data Types, refer to the "EZ-ZONE All Register List."

## Operations List

Default Operations Parameters/Sublists				
<div style="border: 1px solid black; padding: 10px; margin: 10px auto; width: 80%;"> <p>The default parameters in the Operations List vary on every PM PLUS. This list is populated with parameters applicable to the features enabled on the device and the settings chosen in <b>Operations — Setup</b>. (Refer to the configuration code on the device's product label).</p> </div>				
Parameter	Description	Range	Default	ID
Control Mode Active	View the current control mode.	Off (62) Auto (10) Manual (54)	----	8002
Heat Power	View the current heat output level.	0.0 to 100.0%	----	8011
Cool Power	View the current cool output level.	-100.0 to 0.0%	----	8014
Autotune	Start an autotune. While active, "Autotune" displays on the Home Screen.	Yes (106) No (59)	No	8026
<b>Timer Functions</b>				
These appear in the Operations List on devices with T in the 4th digit, for timer enabled models				
Ready Band State	Display whether the process value is in the ready band.	Yes (106) No (59)	----	31022
Ready Band	Set how close the process value must be to the closed loop timer set point to be in the ready band.	0.000 to 9999.000°F or units 0.000 to 5555.000°C	<a href="#">5</a>	31023
Closed Loop Timer Set Point	The set point that will be in effect during the timer period	-1999.000 to 9999.000°F or units -1110.555 to 5555.000°C	75	31028
Hours	Set the timer period hours.	0 to 99	0	31025
Minutes	Set the timer period minutes.	0 to 59	0	31026

## Default Operations Parameters/Sublists

The default parameters in the Operations List vary on every PM PLUS. This list is populated with parameters applicable to the features enabled on the device and the settings chosen in **Operations — Setup**. (Refer to the configuration code on the device's product label).

Parameter	Description	Range	Default	ID
Seconds	Set the timer period seconds.	0 to 59	10	31027
<b>Special Output Function</b>				
These appear in Operations on devices with a V in the 12th digit of the configuration code.				
Source Value A	Special Output Function (1) View the value of Source A.	-1,999.000 to 9,999.000°F or units -1,128.000 to 5,537.000°C	----	35007
Source Value B	Special Output Function (1) View the value of Source B.	-1,999.000 to 9,999.000°F or units -1,128.000 to 5,537.000°C	----	35008
Output Value 1	Special Output Function (1) View the value of this function's Output 1.	-1,999.000 to 9,999.000°F or units -1,128.000 to 5,537.000°C	----	35010
Output Value 2	Special Output Function (1) View the value of this function's Output 2.	-1,999.000 to 9,999.000°F or units -1,128.000 to 5,537.000°C	----	35012
<b>Profile Functions</b>				
These appear in Operations on devices with N or R in the 4th digit of the configuration code. See <b>Operations - Setup</b> for a full list of configurable parameters for this functionality				
Profile Start	Starts the profile	1 to 40	1	22001
Profile Action Request	Requests any of the range of actions	None (61) Step (89) End (148) Resume (147) Pause (146) Profile (77)	None	22011
Profile Status	Currently running step in the profile	1 to 40	----	22004

## Adding Custom Parameters to the Operations List

Up to 20 custom parameters can be added to the Operations List. The parameters available for selection vary depending on the configuration code of your device. Refer to your product label for the configuration code.

1. Navigate to: **Operations — Factory — Custom Setup — Custom Setup [1-20] — Parameter**
2. Scroll to and select the parameter to display. Refer to table: "Operations List - Custom Parameter Options."

Operations List - Custom Parameter Options
All Models
Analog Input Value (Instances 1 or 2)
Cal In Offset (Instances 1 or 2)
Display Units
Load Parameter Set (Instances 1 or 2)
Alarm Low Set Point (Instances 1, 2, 3, or 4)
Alarm High Set Point (Instances 1,2, 3, or 4)
Alarm Hysteresis (Instances 1, 2, 3, or 4)
Additional Parameters Available if 4th digit of configuration code is T
Time Remaining
Ready Band State
Ready Band
Closed Loop Timer Set Point
Hours
Minutes
Seconds
Additional Parameters Available if 4th or 9th digit of configuration code is L or M
Limit Set Point Low
Limit Set Point High
Limit Hysteresis
Limit Status
Additional Parameters Available if 4th digit of configuration code is B, E, C, R, J, or N for Instance 1, and 9th character is C or J for Instance 2.
Set Point (Instances 1 or 2)
Active Process Value (Instances 1 or 2)
Active Set Point (Instances 1 or 2)
Manual Power (Instances 1 or 2)
Autotune (Instances 1 or 2)
Control Mode (Instances 1 or 2)
Heat Power (Instances 1 or 2)
Cool Power (Instances 1 or 2)
Time Integral (Instances 1 or 2)

Time Derivative (Instances 1 or 2)
Dead Band (Instances 1 or 2)
Heat Prop Band (Instances 1 or 2)
On/Off Heat Hysteresis (Instances 1 or 2)
Cool Prop Band (Instances 1 or 2)
On/Off Cool Hysteresis (Instances 1 or 2)
Ramp Rate (Instances 1 or 2)
TRU-TUNE+ Enable (Instances 1 or 2)
Idle Set Point (Instances 1 or 2)
Additional Parameters Available if 4th digit of configuration code is B, E, R or N
Profile Start
Profile Action Request
Current Step
Step Type
Target Set Point (Instances 1 or 2)
Hour
Minute
Second
Guaranteed Soak Deviation 1
Additional Parameters Available if 9th digit of configuration code is T
Load Current RMS



# Chapter 5: Setup

## Default Configurations for Quick Start

If you are using the default input type, you can simply connect your input and output devices to the control, then power up the control and press the slider or the +/- keys on the front of the control to change the set point from the default value (75°F) to the desired value. As the Set Point increases above the Process Value, output 1 will come on and begin driving the heat output device.

Parameter	Default Setting	To Edit
Analog Input	Thermocouple, type J	Operations — Setup — Analog Input — Sensor Type
Function	Heat	Operations — Setup — Output — Output 1 — Function
Heat Algorithm	PID, cool set to "off"	Operations — Setup — Control Loop — Heat Algorithm
Set Point	75°	Press the numeric slider or +/- keys on the front panel
Control Mode	Auto	Operations — Control Mode

### Configuring Parameters

1. Press the right arrow key to open the Operations List, then navigate to the parameter following the breadcrumbs indicated, i.e. **Operations — Setup — Analog Input — Sensor Type**. Use the +/- keys to scroll and the right arrow key to select the highlighted parameter.
2. Use the numeric slider or +/- keys to either highlight or enter the desired option/setting for the parameter.
3. Press the home, left or right arrow key to select the option highlighted/entered.
4. Press the left back arrow to return to the previous List, or press the Home icon to exit all Lists and return to the home screen.

### Using Watlow Software to Configure Parameters

You can set up all parameters directly from the PM PLUS™ front panel via the **Setup** List, as explained in this manual, or use Watlow CONFIGURATOR or COMPOSER on a PC. If you choose to use Watlow CONFIGURATOR or COMPOSER software to set up the PM PLUS™ from your PC, you'll need to wire to the Standard Bus communications (see Chapter 2). There are two ports (instances) for communications. Port 1 is dedicated to Standard Bus communications. Port 1 may also be used for Modbus® RTU if purchased. Port 2 may be used with Modbus®, DeviceNet, Ethernet/IP, J1939 CAN, or Profibus.

For detailed information about Modbus®, CIP or Profibus addresses, and Data Types, refer to the "EZ-ZONE All Register List." on the Watlow website. On the following pages, the Setup Lists show the Parameter ID. This Parameter ID is a cross reference, to the "EZ-ZONE All Register List"; for the Modbus Registers, CIP or Profibus addresses, and Data Types.

Range selections can be made by writing the enumerated value of choice using any of the available communications protocols. For example, to turn an analog input sensor off (as seen at **Operations — Setup — Analog Input — Sensor Type**) using Modbus®, write the value 62 (off) to register 368 and send that value to the control.

# Setup List

## Setup Lists

You will not see every parameter listed here. These vary depending on the features enabled on your device.

### Analog Input List

#### Operations — Setup — Analog Input

Parameter	Description	Range of Options	Default	Parameter ID
Analog Input [1,2]	The process value of the input. Select instance 1 or 2 if there are two input instances. (Without two analog input instances, Analog 1 will be automatically selected/displayed and Analog 2 will not appear).  Note: Ensure that there is no Input Error (61) when reading this value using a field bus protocol. If an error exists, the last known value prior to the error will be returned.	-1,999.000 to 9,999.000°F or units -1,128.000 to 5,537.000°C	- - - -	4001

#### Operations — Setup — Analog Input — [Analog Input 1, Analog Input 2]

Parameter	Description	Range of Options	Default	Parameter ID
Sensor Type	Analog sensor type wired to this input. Note: There is no open sensor protection for process inputs.	Off (62) Thermocouple (95) Millivolts (56) Volts dc (104) Milliamps dc (112) RTD 100 Ω (113) RTD 1,000 Ω (114) Potentiometer 1 kΩ (155) Thermistor (229)	Thermocouple or Thermistor	4005
TC Linearization	Thermocouple linearization wired to this input.	B (11) K (48) C (15) N (58) D (23) R (80) E (26) S (84) F (30) T (93) J (46)	J	4006
RTD Leads	Quantity of leads on the RTD wired to this input.	2 (1) 3 (2)	2	4007

## Setup Lists

You will not see every parameter listed here. These vary depending on the features enabled on your device.

Parameter	Description	Range of Options	Default	Parameter ID
Units	Type of units the sensor measures.	Absolute Temperature (1540) Relative Humidity (1538) Process (75) Power (73)	Process	4042
Scale Low	Low scale for process inputs. This value, in millivolts, volts or milliamps, corresponds to the Range Low output	-100.00 to 1,000.00	0. 0	4015
Scale High	High scale for process inputs. This value in millivolts, volts or milliamperes corresponds to the Range High output of this function block.	-100.00 to 1,000.00	20.0	4016
Range Low	Set the low range for this function block's output.	-1,999.000 to 9,999.000	0.0	4017
Range High	Set the high range for this function block's output.	-1,999.000 to 9,999.000	9,999	4018
Process Error Enable	Turn the Process Error Low feature on or off.	Off (62) Low (53)	Off	4030
Proc.Error Low Value	If the process value drops below this value, it will trigger an input error.	-100.00 to 1,000.00	0.0	4031
Thermistor Curve	Select a curve to apply to the thermistor input.	Curve A (1451) Curve B (1452) Curve C (1453) Custom (180)	Curve A	4038
Resistance Range	Set the maximum resistance of the thermistor input.	5K (1448) 10K (1360) 20K (1361) 40K (1449)	40K	4037
Filter	Filtering smooths out the process signal to both the display and the input. Increase the time to increase filtering. Note: Filter does not apply to the Limit sensor but does apply to all other functions.	0.0 to 60.0 seconds	0.5	4014
Input Error Latching	Turn input error latching on or off. If latching is on, errors must be manually cleared.	Off (62) On (63)	Off	4028
Display Precision	Set the precision of the displayed value.	Whole (105) Tenths (94) Hundredths (40) Thousandths (96)	Whole	4020
Calibration Offset	Offset the input reading to compensate for lead wire resistance or other factors that cause the input reading to vary from the process value.	-1,999.000 to 9,999.000°F or units -1,110.555 to 5,555.000°C	0.0	4012
Analog Input Value	View the process value. Prior to reading this register, read the Input Error, Parameter ID 4002. Ensure that Input Error is "None", (61). If an error exists, the last known value prior to the error will be returned for this Analog Input Value.	-1,999.000 to 9,999.000°F or units -1,128.000 to 5,537.000°C	- - - -	4001

## Setup Lists

You will not see every parameter listed here. These vary depending on the features enabled on your device.

Parameter	Description	Range of Options	Default	Parameter ID
Input Error	View the cause of the most recent error.	None (61) Open (65) Shorted (127) Measurement Error (140) Bad Calibration Data (139) Ambient Error (9) RTD Error (141) Fail (32)	----	4002

### Digital Bus List

#### Operations — Setup — Digital Bus (J1939 CAN) —

J1939 Instance	Select the instance.	1 to 6	----	----
----------------	----------------------	--------	------	------

#### Operations — Setup — Digital Bus (J1939 CAN) — [Digital Bus 1,2,3,4,5,6] —

Units	Set the type of units the sensor will measure.	Absolute Temperature (1540) Relative Temperature (1541) Power (73) Process (75) Relative Humidity (1538) None (61)	Absolute Temperature	95005
Input Value	View the input value.	-1,999.000 to 9,999.000	----	95001
Input Error	Selected sensor instance is in error state.	None (61) Open (65) Shorted (127) Measurement Error (140) Bad Calibration Data (139) Ambient Error (9) RTD Error (141) Fail (32) Math Error (1423) Not Sourced (246) Stale (883)	Stale	95002
Output Value	View the output value of Digital Bus 1-6.	-1,999.000 to 9,999.000	----	95003
CAN ID High Word	Digital Bus (1 to 4)	0 to 65,535	0	94023
CAN ID Low Word	Digital Bus (1 to 4)	0 to 65,535	0	94022
Encoding Typ	Digital Bus (1 to 6)	State (2008) Slots (2009)	Slots	94005
Start Byte	Digital Bus (1 to 4)	1 to 8	1.0	94006
Start Bit	Digital Bus (1 to 4)	1 to 8	1.0	94007
Signal Length in Bits	Digital Bus (1 to 4)	1 to 63	1.0	94008
Scaling Numerator	Digital Bus (1 to 4)	1 to 65,535	Instance 1,2,3,6 = 128, Instance 4,5 = 1	----
Scaling Denominator	Digital Bus (1 to 4)	1 to 65,535	Instance 1,2,3,6 = 4096, Instance 4, 5 = 1	----

## Setup Lists

You will not see every parameter listed here. These vary depending on the features enabled on your device.

Parameter	Description	Range of Options	Default	Parameter ID
Offset	Digital Bus (1 to 4)	-1,999.000 to 9,999.000	1.0	93010
Filter	Digital Bus (1 to 4)	-1,999.000 to 9,999.000	1.0	93011
CAN Units	Digital Bus (1 to 6)	°F (30) °C (15) None	Instance 5 = None, instance 1,2,3,4, 6 = C	93021
Output Error	Output Error	None (61) Open (65) Shorted (127) Measurement Error (140) Bad Calibration Data (139) Ambient Error (9) RTD Error (141) Fail (32) Math Error (1423) Not Sourced (246) Stale (883)	Stale	95004
Action Function	Select the function that will be triggered by a true state for Digital Inputs 5 or 6.	None (61) Start Step (1077) Profile Start/Stop, level triggered (208) Start Profile, edge triggered (196) Profile Hold/Resume, level triggered (207) Profile Disable, level triggered (206) TRU-TUNE+ Disable, level triggered (219) Switch Control Loop Off, level triggered (90) Manual, level triggered (54) Tune, edge triggered (98) Idle Set Point, level triggered (107) Force Alarm, level triggered (218) Control Loops Off and Alarms to Non-alarm State, level triggered (220) Silence Alarms, edge triggered (108) Alarm Reset, edge triggered (6) Keypad Lockout, level triggered (217) User Set Restore, edge triggered (227) Remote Set Point (216)	None	10003
Function Instance	Select which Digital Input will be triggered by a true state.	0 to 40	0	10004

## Setup Lists

You will not see every parameter listed here. These vary depending on the features enabled on your device.

### Linearization List

Operations — Setup — Linearization — [Linearization 1, Linearization 2] —

Parameter	Description	Range of Options	Default	Parameter ID
Function	Set how this function will linearize Source A.	Off (62) Interpolated (1482)	Off	34005
Source Function A	Set the source for the Linearization function. Note: Instance 2 applies if configuration code digit 8 = 7 or K; or digit 9 = C, J, R or P.	Analog Input (142) Digital Bus Input (1993)		34001
Source Instance A	Set the instance of the function. Note: Instance 2 applies if configuration code digit 8 = 7 or K ; or digit 9 is C, J, R or P.	1 to 8		34002
Units	Set the units of the output value.	Source (1539) None (61) Absolute Temperature (1540) Relative Temperature (1541) Power (73) Process (75) Relative Humidity (1538)	Source	34029
Input Point 1	The value that will be mapped to output 1.	-1,999.000 to 9,999.000	0.0	34008
Output Point 1	The value that will be mapped to input 1.	-1,999.000 to 9,999.000	0.0	34018
Input Point 2	The value that will be mapped to output 2.	-1,999.000 to 9,999.000	1.0	34009
Output Point 2	The value that will be mapped to input 2.	-1,999.000 to 9,999.000	1.0	34019
Input Point 3	The value that will be mapped to output 3.	-1,999.000 to 9,999.000	2.0	34010
Output Point 3	The value that will be mapped to input 3.	-1,999.000 to 9,999.000	2.0	34020
Input Point 4	The value that will be mapped to output 4.	-1,999.000 to 9,999.000	3.0	34011
Output Point 4	The value that will be mapped to input 4.	-1,999.000 to 9,999.000	3.0	34021
Input Point 5	Set the value mapped to output 5.	-1,999.000 to 9,999.000	4.0	34012
Output Point 5	Set the value mapped to input 5.	-1,999.000 to 9,999.000	4.0	34022
Input Point 6	Set the value mapped to output 6.	-1,999.000 to 9,999.000	5.0	34013
Output Point 6	Set the value mapped to input 6.	-1,999.000 to 9,999.000	5.0	34023
Input Point 7	Set the value mapped to output 7.	-1,999.000 to 9,999.000	6.0	34014
Output Point 7	Set the value mapped to input 7.	-1,999.000 to 9,999.000	6.0	34024
Input Point 8	Set the value mapped to output 8.	-1,999.000 to 9,999.000	7.0	34015

## Setup Lists

You will not see every parameter listed here. These vary depending on the features enabled on your device.

Parameter	Description	Range of Options	Default	Parameter ID
Output Point 8	Set the value mapped to input 8.	-1,999.000 to 9,999.000	7.0	34025
Input Point 9	Set the value mapped to output 9.	-1,999.000 to 9,999.000	8.0	34016
Output Point 9	Set the value mapped to input 9.	-1,999.000 to 9,999.000	8.0	34026
Input Point 10	Set the value mapped to output 10.	-1,999.000 to 9,999.000	9.0	34017
Output Point 10	Set the value mapped to input 10.	-1,999.000 to 9,999.000	9.0	34027

### Process Value List

Operations — Setup — Process Value — [Process Value 1, Process Value 2] —

Function	Set the function that will be applied to the source or sources.  Note: Differential and Ratio not available using instance 2.	Off (62) Pressure to Altitude (1649)*** Square Root (1380) Differential (1373) Ratio (1374) Wet Bulb Dry Bulb (1369) Vaisala (1648) Sensor Backup (1201)	Off	26021
Pressure Units***	If Process Value function is set for Pressure to Altitude units, define units of measure for conversion.	Pounds per Square Inch (1671) Pascal (1674) Atmosphere (1675) Millibar (1672) Torr (1673)	PSI	26028
Altitude Units***	If Process Value function is set for Pressure to Altitude units, define units of measure for conversion.	Kilofeet (1677) Feet (1676)	Hft	26029
Barometric Pressure***	If Process Value function is set for Wet Bulb / Dry Bulb, define pressure value used for humidity calculation.	10.0 to 16.0	14.7	26030
Filter	Filtering smooths out the output signal of this function block. Increase the time to increase filtering.	0.0 to 60.0 seconds	0.0	26026

\*\*\* Pressure Altitude calculation is based on the International Standard Atmosphere 1976

Source Value A	The value of Source A. Linearization 1 is connected to Source A of Process Value 1. Linearization 2 is connected to Source A of Process Value 2	-1,999.000 to 9,999.000°F or units -1,128.000 to 5,537.000°C	- - - -	26016
Source Value B	View the value of Source B. Linearization 2 is connected to Source B of Process Value 1. Linearization 1 is connected to Source B of Process Value 2	-1,999.000 to 9,999.000°F or units -1,128.000 to 5,537.000°C	- - - -	26017
Offset	The offset to be applied to this function's output.	-1,999.000 to 9,999.000°F or units -1,128.000 to 5,537.000°C	0	26023
Output Value	View the value of this function block's output.	-1,999.000 to 9,999.000°F or units -1,128.000 to 5,537.000°C	- - - -	26022

## Setup Lists

You will not see every parameter listed here. These vary depending on the features enabled on your device.

### Digital Input/Output List

*Operations — Setup — Digital I/O — [Digital I/O 5 through 12] —*

Parameter	Description	Range of Options	Default	Parameter ID
Direction	Set this function to operate as an input or output.	Output (68) Input Voltage (193) Input Dry Contact (44)	Output	6001
Function	Select what function will drive this output.	Off (62) Alarm (6) Heat (36) Cool (20) Heater Error (184)	Off	6005
Output Function Instance	Set the instance of the function selected.	1 to 4	1	6006
Time Base Type	Set the time base type. This parameter is only used with PID control, but can be set anytime.	Fixed Time Base (34) Variable Time Base (103)	Fixed Time Base	6002
Fixed Time Base	Set the time base for fixed-time-base control.	0.1 to 60.0 seconds	1.0	6003
Low Power Scale	The power output will never be less than the value specified and will represent the value at which output scaling begins.	0.0 to 100.0%	0.0	6009
High Power Scale	The power output will never be greater than the value specified and will represent the value at which output scaling stops.	0.0 to 100.0%	100.0	6010
Active Level	Select which action will be interpreted as a true state.	High (37) Low (53)	High	10001



## Setup Lists

You will not see every parameter listed here. These vary depending on the features enabled on your device.

Parameter	Description	Range of Options	Default	Parameter ID
Active Function	Select the function that will be triggered by a true state for Digital Inputs 5 to 6.	None (61) User Set Restore, edge triggered (227) Keypad Lockout, level triggered (217) Alarm Reset, edge triggered (6) Silence Alarms, edge triggered (108) Start Step, edge triggered (1077) Profile Start/Stop, level triggered (208) Start Profile, edge triggered (196) Profile Hold/Resume, level triggered (207) Profile Disable, level triggered (206) Control Loops Off and Alarms to Non-alarm State, level triggered (220) Remote Set Point, level triggered (216) Force Alarm to occur, level triggered (218) Idle Set Point, level triggered (107) Tune, edge triggered (98) Manual, level triggered (54) Switch Control Loop Off, level triggered (90) TRU-TUNE+ Disable, level triggered (219)	None	10003
Function Instance	Select which Digital Input will be triggered by a true state.	0 to 40	0	10004
<b>Limit List</b>				
<i>Operations — Setup — Limit —</i>				
Sides	Select the side or sides of the process value to be monitored.	Both (13) High (37) Low (53)	Both	12005

## Setup Lists

You will not see every parameter listed here. These vary depending on the features enabled on your device.

Parameter	Description	Range of Options	Default	Parameter ID
Hysteresis	Set the hysteresis for the limit function. This determines how far into the safe range the process value must move before the limit can be cleared.	0.001 to 9,999.000°F or units 0.001 to 5,555.000°C	3.0°F or units 2.0°C	12002
Maximum Set Point	Set the high end of the limit set point range.	-1,999.000 to 9,999.000	9,999.000	12009
Minimum Set Point	Set the low end of the limit set point range.	-1,999.000 to 9,999.000	-1,999.000	12010
High Limit Set Point	Set the high process value that will trigger the limit.	-1,999.000 to 9,999.000°F or units -1,128.000 to 5,537.000°C	0.0°F or units -18.0°C	12004
Low Limit Set Point	Set the low process value that will trigger the limit.	-1,999.000 to 9,999.000°F or units -1,128.000 to 5,537.000°C	0.0°F or units -18.0°C	12003
Source Function A	Set the source for the limit reset function.	None (61) Digital I/O (1142) Function Key (1001)	None	12015
Source Instance A	Set the instance of the function selected.	1 to 12	1	12016
Clear Limit	Clear limit once limit condition is safe.	Clear (0) Ignore (204)	----	12014
Limit Status	Reflects whether or not the limit is in a safe or failed mode.	Fail (32) Safe (1667)	----	12013
Integrate with System	In a limit state the controller will turn off the outputs, terminate an active profile and freeze PID and TRU-TUNE+ <sup>®</sup> calculations.	No (59) Yes (106)	No	12008

## Control Loop List

*Operations — Setup — Control Loop —*

Control Loop [1,2]	Select the Control Loop instance to configure.	1,2	1	
--------------------	--	-----	---	--

*Operations — Setup — Control Loop — [Control Loop 1, Control Loop 2] —*

Heat Algorithm	Set the heat control method.	Off (62) PID (71) On-Off (64)	PID	8003
Cool Algorithm	Set the cool control method.	Off (62) PID (71) On-Off (64)	Off	8004
Cool Output Curve	Select a cool output curve to change the responsiveness of the system.	Off (62) Non-linear Curve 1 (214) Non-linear Curve 2 (215)	Off	8038
Heat Prop. Band	Heat Proportional Band. Set the PID proportional band for the heat outputs.	0.001 to 9,999.000°F or units 0.001 to 5,555.000°C	25.0°F or units 14.0°C	8009
On / Off Heat Hyster.	On/Off Heat Hysteresis. Set the control switching hysteresis for on-off control. This determines how far into the “on” region the process value needs to move before the output turns on.	0.001 to 9,999.000°F or units 0.001 to 5,555.000°C	3.0°F or units 2.0°C	8010
Cool Prop. Band	Cool Proportional Band. Set the PID proportional band for the cool outputs.	0.001 to 9,999.000°F or units 0.001 to 5,555.000°C	25.0°F or units 14.0°C	8012

## Setup Lists

You will not see every parameter listed here. These vary depending on the features enabled on your device.

Parameter	Description	Range of Options	Default	Parameter ID
On/Off Cool Hyster.	On/Off Cool Hysteresis. Set the control switching hysteresis for on-off control. This determines how far into the “on” region the process value needs to move before the output turns on.	0.001 to 9,999.000°F or units 0.001 to 5,555.000°C	3.0°F or units 2.0°C	8013
Time Integral	Set the PID integral for the outputs.	0 to 9,999 seconds per repeat	180 seconds per repeat	8006
Time Derivative	Set the PID derivative time for the outputs.	0 to 9,999 seconds	0 seconds	8007
Dead Band	Set the offset to the proportional band. With a negative value, both heating and cooling outputs are active when the process value is near the set point. A positive value keeps heating and cooling outputs from fighting each other.	-1,000.0 to 1,000.0°F or units -556 to 556°C	0.0	8008
TRU-TUNE+ <sup>®</sup> Enable	Enable or disable the TRU-TUNE+ adaptive tuning feature.	No (59) Yes (106)	No	8022
TRU-TUNE+ Band	The range, centered on the set point, within which TRU-TUNE+ will be in effect. Use this function only if the controller is unable to adaptive tune automatically.	0 to 100	0	8034
TRU-TUNE+ Gain	The responsiveness of the TRU-TUNE+ adaptive tuning calculations. More responsiveness may increase overshoot.	1 to 6	3	8035
Autotune	Start an autotune. While the autotune is active, the Home Screen will display Tuning 1. When the autotune is completed, the message will clear automatically.	No (59) Yes (106)	No	8026
Autotune Set Point	Set point that the autotune will use, as a percentage of the current set point.	50 to 200%	90.0	8025
Autotune Aggressive	The aggressiveness of the autotuning calculations.	Under damped (99) Critical damped (21) Over damped (69)	Critical	8024
Peltier Delay	A value that will cause a delay when switching from heat PID mode to cool PID mode.	0.0 to 5.0 seconds	0.0	8051
Remote Set Point	Whether this loop will use a remote set point.	No (59)    Yes (106)	No	7021
Remote Set Point Type	Set what type of set point will be used.	Auto (10)    Manual (54)	Auto	7022
Auto-to-Manual Power	Select what the controller outputs will do when the user switches control to manual mode.	Off: sets output power to 0% (62) Bumpless transfer: maintains same output power, if it was less than 75% and stable, otherwise 0% (14) Fixed Power: sets output power to Fixed Power (54) User: sets output power to last open-loop set point the user entered (100)	User	7012

## Setup Lists

You will not see every parameter listed here. These vary depending on the features enabled on your device.

Parameter	Description	Range of Options	Default	Parameter ID
Input Error Power	What the controller outputs will do when an input error switches control to manual mode.	Off, sets output power to 0% (62) Bumpless transfer, maintains same output power, if it was less than 75% and stable, otherwise 0% (14) Fixed Power, sets output power to Fixed Power setting (54) User, sets output power to last open-loop set point the user entered (100)	User	7013
Fixed Power	Manual output power level that will take effect if an input error failure occurs while User Failure Action is set to Fixed Power.	Set Point Open Loop Limit Low to Set Point Open Loop Limit High (Setup Page)	0.0	7011
OpLoop Detect Enable	Open Loop Detect Enable. Select Yes to detect conditions that prevent the process from changing in specified time frame by a specified amount when PID power is at 100%. An open loop detect error will disable the control loop.	No (59) Yes (106)	No	8039
OpLoop Detect Time	Open Loop Detect Time. Process must deviate by the Open Loop Detect Deviation value in the specified time, while at 100% PID power, otherwise an Open Loop Detect event is triggered.	0 to 3,600 seconds	240	8040
OpLoop Detect Dev	Open Loop Detect Deviation. Process must deviate by this value in the Open Loop Detect Time while at 100% PID power to prevent an open loop error.	-1,999.000 to 9,999.000°F or units -1,110.555 to 5,555.000°C	10.0°F or units 6.0°C	8041
Ramp Action	Select when the controller's set point will ramp to the defined end set point.	Off (62) Startup (88) Set Point Change (85) Both (13)	Off	7014
Ramp Scale	Scale of the ramp rate.	Hours (39) Minutes (57)	Minutes	7015
Ramp Rate	Rate for the set point ramp. Set the time units for the rate with the Ramp Scale parameter.	0.0 to 9,999.000°F or units 0.0 to 5,555.000°C	1.0°F or units 1.0°C	7017
Minimum Set Point	Minimum value of the closed loop set point range.	-1,999.000 to 9,999.000°F or units -1,128.000 to 5,537.000°C	-1,999°F or units -1,128°C	7003
Maximum Set Point	Maximum value of the closed loop set point range.	-1,999.000 to 9,999.000°F or units -1,128.000 to 5,537.000°C	9,999°F or units 5,537°C	7004
Set Point	Closed loop set point that the controller will automatically control to.	-1,999.000 to 9,999.000°F or units -1,128.000 to 5,537.000°C	75.0°F or units 24.0°C	7001
Idle Set Point	Closed loop set point that can be triggered by an event state.	-1,999.000 to 9,999.000°F or units -1,128.000 to 5,537.000°C	75.0°F or units 24.0°C	7009
Minimum Manual Power	Minimum value of the open-loop set point range.	-100.0 to 100.0%	-100	7005

## Setup Lists

You will not see every parameter listed here. These vary depending on the features enabled on your device.

Parameter	Description	Range of Options	Default	Parameter ID
Maximum Manual Power	Maximum value of the open-loop set point range.	-100.0 to 100.0%	100	7006
Manual Power *	Fixed level of output power when in manual (open-loop) mode.	-100.0 to 100.0% (heat and cool) 0 to 100.0% (heat only) -100.0 to 0% (cool only)	0.0	7002
Control Mode *	Method that this loop will use to control.	Off (62) Auto (10) Manual (54)	Auto	8001

### Output List

*Operations — Setup — Output —*

Output 1,2,3,4	Select the output instance to configure	1,2,3,4	1	
----------------	---	---------	---	--

*Operations — Setup — Output — Output [1,2,3,4] —*

Function	Output Digital (1 to 4). Select what function will drive this output.  Note: When digit 9 in the part number = L or M, output 4 is always fixed as a limit function. In addition, only output 3 can be programmed as a limit function.	Off (62) Alarm (6) Heat (36) Cool (20) Special Function Output 1 (1532) Special Function Output 2 (1533) Timer Event 1 (1951) Timer Event 2 (1952) Timer Event 3 (1953) Profile Event Out A (233) Profile Event Out B (234) Limit (126)	Output 1 - Heat Output 2 - Alarm Output 3 - Off Output 4 - Off	6005
Output Function Instance	Output Digital (1 to 4). Set the instance of the function selected.	1 to 4	1	6006
Time Base Type	Output Digital (1 to 4). Set the time base type. This parameter is only used with PID control, but can be set anytime.	Fixed Time Base (34) Variable Time Base (103)	Fixed Time Base	6002
Fixed Time Base	Output Digital (1 to 4). Set the time base for fixed-time-base control.	1.0 to 60.0 seconds (solid-state relay or switched dc) 5.0 to 60.0 seconds (mechanical relay or NO-ARC power control)	1.0 sec. for SSR or swdc 5.0 for relay	6003
Low Power Scale	Output Digital (1 to 4). The power output will never be less than the value specified and will represent the value at which output scaling begins.	0.0 to 100.0%	0.0%	6009
High Power Scale	Output Digital (1 to 4). Power output will never be greater than the value specified and represents the value at which output scaling stops.	0.0 to 100.0%	100.0%	6010

## Setup Lists

You will not see every parameter listed here. These vary depending on the features enabled on your device.

Parameter	Description	Range of Options	Default	Parameter ID
<b>The next parameters are for Outputs that are Process.</b>				
Type	Output Process (1 or 3). Select whether the process output operates in volts or milliamps.	Volts (104) Milliamps (112)	Volts	18001
Function	Output Process (1 or 3). Set the type of function that will drive this output.	Off (62) Heat (36) Cool (20) Duplex (212) Alarm (6) Profile Event Out A (233) Profile Event Out B (234) Retransmit (213)	Off	18002
Retransmit Source	Output Process (1 or 3). Select the value that will be retransmitted.	Analog Input (142) Set Point (85) Current Sample and hold (22) Process Value (241)	Analog Input	18003
Function Instance	Output Process (1 or 3). Set the instance of the function selected above.	1 to 4	1	18004
Scale Low	Output Process (1 or 3). Set the scale low for process output in electrical units. This value in volts or milliamps, corresponds to 0% PID power output or range low retransmit output.	-100.0 to 100.0	0.00	18009
Scale High	Output Process (1 or 3). Set the scale high for process output in electrical units. This value in volts or milliamps, corresponds to 100% PID power output or range high retransmit output.	-100.0 to 100.0	10.00	18010
Range Low	Output Process (1 or 3). Set the minimum value of the retransmit value range in process units. When the retransmit source is at this value, the retransmit output will be at its Scale Low value.	-1,999.000 to 9,999.000°F or units -1,128.000 to 5,537.000°C	0.0°F or units -18°C	18011
Range High	Output Process (1 or 3). Set the maximum retransmit value in process units. When the retransmit source is at this value, the retransmit output is at its Scale High value.	-1,999.000 to 9,999.000°F or units -1,128.000 to 5,537.000°C	100.0°F or units 38.0°C	18012
Calibration Offset	Output Process (1 or 3). Set an offset value for a process output.	-1,999.000 to 9,999.000°F or units -1,110.555 to 5,555.000°C	0.0°F or units 0.0°C	18007

### Alarm List

*Operations — Setup — Alarm — Alarm [1,2,3,4] —*

Type	Select whether the alarm trigger is a fixed value or will track the set point.	Off (62) Process Alarm (76) Deviation Alarm (24)	Off	9015
------	--	--	-----	------

## Setup Lists

You will not see every parameter listed here. These vary depending on the features enabled on your device.

Parameter	Description	Range of Options	Default	Parameter ID
Alarm Source	Select what will trigger this alarm. Note: When using Deviation Alarms with Differential control, the Alarm Source must be set to Process Value.	None (61) Analog Input (142) Linearization (238) Process Value (241) Power (73) Digital Bus Input (1993) Load Current RMS (179) Current Read is Sample and Hold (22)		9017
Alarm Source Instance (Alarm Source Inst <sup>o</sup> )	Set the instance of the function selected above.	1 or 2	1	9018
Control Loop	Set the instance of the Set Point Closed, Control Loop, to be referenced by the deviation alarm.  Note: Not available on single loop models.	1 to 2	1	9023
Hysteresis	Set the hysteresis for an alarm. This determines how far into the safe region the process value needs to move before the alarm can be cleared.	0.001 to 9,999.000°F or units 0.001 to 5,555.000°C	1.0°F or units 1.0°C	9003
Logic	Select what the output condition will be during the alarm state.	Energize on alarm (17) De-energize on alarm (66)	Close On Alarm	9005
Sides	Select which side or sides will trigger this alarm.	Both (13) High (37) Low (53)	Both	9004
Low Set Point	If Type is set to Process: the process value that triggers a low alarm. If type is set to Deviation: the span of units from the closed loop set point that will trigger a low alarm. A negative set point represents a value below closed loop set point. A positive set point represents a value above closed loop set point.	-1,999.000 to 9,999.000°F or units -1,128.000 to 5,537.000°C	32.0°F or units 0.0°C	9002
High Set Point	If Type is set to Process: set the process value that triggers a high alarm. If type is set to Deviation: set the span of units from the closed loop set point that triggers a high alarm.	-1,999.000 to 9,999.000°F or units -1,128.000 to 5,537.000°C	300.0°F or units 150.0°C	9001
Latching	Turn latching on or off. A latched alarm has to be turned off by the user.	Non-Latching (60) Latching (49)	Non-Latching	9007
Blocking	Select when an alarm is blocked. After startup and/or after the set point changes, the alarm is blocked until the process value enters the normal range.	Off (62) Startup (88) Set Point (85) Both (13)	Off	9008
Silencing	Turn silencing on to allow the user to disable this alarm.	Off (62) On (63)	Off	9006
Display	Display an alarm message when an alarm is active.	Off (62) On (63)	On	9016

## Setup Lists

You will not see every parameter listed here. These vary depending on the features enabled on your device.

Parameter	Description	Range of Options	Default	Parameter ID
Delay Time	Set the time that the alarm will be delayed after the process value exceeds the alarm set point.	0 to 9,999 seconds	0	9021
Clear Alarm	Clears the alarm instance	Clear (0) Ignore (204)	----	9013
Silence Alarm	Silences the alarm instance. If an alarm is setup to silence alarm when active the display will state this. Do not mistake this parameter for " <b>Operations - Setup - Alarm - Alarm [1,2,3,4] - Silencing</b> " which turns the ability to silence alarms on or off.	Silence (1010)	----	9014
Alarm State	Current state of alarm	Startup (88) None (61) Blocked (12) Alarm low (8) Alarm high (7) Error (28)	----	9009

### Current List

*Operations — Setup — Current —*

Sides	Select which side or sides will be monitored.	Off (62) High (37) Low (53) Both (13)	off	15005
Indicate Reading	Use to display solid-state relay (SSR) failure and heater failure messages.	No (59) Yes (106)	no	15004
Input Detection Threshold	For factory adjustment only.	3 to 59	9	15012
Input Scaling	Adjust scaling to match the transformer's high range.	0 to 9,999.000	50.0	15022
Heater Offset	Calibrate the current reading with an offset value.	-9,999.000 to 9,999.000	0.0	15011
Monitored Output	Select which output instance the current transformer will monitor.	1 to 12	1	15019
High Set Point	Set the current value that will trigger a high heater error state.	-1,999.000 to 9,999.000	50.0	15008
Low Set Point	Set the current value that will trigger a low heater error state.	-1,999.000 to 9,999.000	0.0	15009

### Timer List

*Operations — Setup — Timer [1] —*

Timer Enable	Enable the timer function.	Yes (106) No (59)	Yes	31029
Timer Start Method	Select what will start the timer.	Immediate (1049) Ready Band (1942) Ready Ack (1950) Power (73)	Immediate	31030
Source Function A	Select which input will start or terminate the timer.	Function Key (1001) None (61) Digital I/O (1142)	Function Key	31001



## Setup Lists

You will not see every parameter listed here. These vary depending on the features enabled on your device.

Parameter	Description	Range of Options	Default	Parameter ID
Source Instance A	Select an instance of Function A.	1 to 24	8	31003
Source Function C	Select the analog source for the ready band.	Process Value (241) None (61) Analog Input (142) Linearization (238)	Process Value	31031
Source Instance C	Select an instance of Function C.	1 to 24	1	31033
Source Function D	Select which input will acknowledge the ready band.	Function Key (1001) None (61) Digital I/O (1142)	Function Key	31032
Source Instance D	Select an instance of Function D.	1 to 24	7	31034
Time Remaining	Display the time remaining on the timer.	00:00 to 99:59	7	31021
Ready Band State	Display whether the process value is in the ready band.	Yes (106) No (59)	----	31022
Ready Band	Set difference of process value to the closed-loop timer set point to be in the ready band.	0.000 to 9999.000°F or units 0.000 to 5555.000°C	5.000	31023
Time Format	Select the time format.	Time Minutes:Seconds (1943) Time Hours:Minutes (1944)	Time Minutes:Seconds	31024
Hours	Set the timer period hours.	0 to 99	0	31025
Minutes	Set the timer period minutes.	0 to 59	0	31026
Seconds	Set the timer period seconds.	0 to 59	10	31027
Closed Loop Timer Set Point ("Closed Loop Timer SP")	Set the set point that will be in effect during the timer period.	-1999.000 to 9999.000°F or units -1110.555 to 5555.000°C	75	31028
Signal Time	Set the period of time that a signal output to be activated after the timer period is complete. Assign a digital output for this function in Timer Event Output 3.	1 to 3600 Seconds	1	31045

### Math List

*Operations — Setup — Math —*

Source Value A	Math (1) View the value of Source A.	-1,999.000 to 9,999.000°F or units -1,128.000 to 5,537.000°C	---	25016
Source Value B	Math (1) View the value of Source B.	-1,999.000 to 9,999.000°F or units -1,128.000 to 5,537.000°C	---	25017
Source Value E	View the value of Source E.	Off (62) On (63)	---	25020
Offset	Set an offset to be applied to this function's output.	-1,999.000 to 9,999.000°F or units -1,128.000 to 5,537.000°C	---	25023
Function	Set the operator that will be applied to the sources.	Off Process Scale Deviation Scale	Off	25021

## Setup Lists

You will not see every parameter listed here. These vary depending on the features enabled on your device.

Parameter	Description	Range of Options	Default	Parameter ID
Source Function E	Set the type of function that will be used for this source.	None Function Key Digital I/O	None	25005
Source Instance E	Set the instance of the function selected above.	1 to 12	1	25010
Scale Low	This value corresponds to Output Range Low.	-1,999.000 to 9,999.000	0.0	25024
Scale High	This value corresponds to Output Range High.	-1,999.000 to 9,999.000	1.0	25025
Range Low	This value corresponds to Input Scale Low.	-1,999.000 to 9,999.000	0.0	25026
Range High	This value corresponds to Input Scale High.	-1,999.000 to 9,999.000	1.0	25027
Filter	Filtering smooths out the output signal of this function block. Increase the time to increase filtering.	0 to 60 seconds	0.0	25028

## Special Output Function

### Operations — Setup — Special Output Function —

Function	Set the function to match the device it will operate.	Off (62) Motorized Valve (1508) Compressor Control (1506)	Off	35009
Source Function A	Set the type of function that will be used for this source.	None (61) Power (73) Heat Power (160) Cool Power (161)	None	35001
Source Instance A	Set the instance of the function selected above.	1 to 2	1	35003
Source Function B	Set the type of function that will be used for this source.	None (61) Power (73) Heat Power (160) Cool Power (161)	None	35002
Source Instance B	Set the instance of the function selected.	1 to 2	1	35004
Input A Turn On	Compressor 1 power on level.	-100.00 to 100.00%	0	35018
Input A Turn Off	Compressor 1 power off level.	-100.00 to 100.00%	5	35019
Input B Turn On	Compressor 2 power on level.	-100.00 to 100.00%	0	35020
Input B Turn Off	Compressor 2 power off level.	-100.00 to 100.00%	5	35021
Minimum On Time	At a minimum stay on specified amount of time.	0 to 9,999 seconds	20	35022
Minimum Off Time	At a minimum stay off specified amount of time.	0 to 9,999 seconds	20	35023
Valve Travel Time	The amount of time it takes the valve to fully open and then fully close.	10 to 9,999 seconds	120	35024
Dead Band	Output power needs to change by specified level prior to turning on.	1.0 to 100.0%	2	35025
Time Delay	If requested power is 0.0% for longer than the specified Time Delay, the compressor will shut off.	0 to 9,999 seconds	0	35026

## Setup Lists

You will not see every parameter listed here. These vary depending on the features enabled on your device.

### Function Key

#### Operations — Setup — Function Key —

Parameter	Description	Range of Options	Default	Parameter ID
Active Level	The Function Key will always power up in the low state. Pressing the Function Key will toggle the selected action.	High (37) Low (53)	High	10001
Action Function	Function Key (1 to 2) Program the EZ Key to trigger an action. Functions respond to a level state change or an edge level change.	None (61) Remote Set Point (216) Limit Reset, edge triggered (82) User Set Restore, edge triggered (227) Keypad Lockout, level triggered (217) Trending (2069) Alarm Reset, edge triggered (6) Silence Alarms, edge triggered (108) Control Loops Off and Alarms to Non-alarm State, level triggered (220) Force Alarm to occur, level triggered (218) Idle Set Point, level triggered (107) Tune, edge triggered (98) Manual, level triggered (54) Switch Control Loop Off, level triggered (90) TRU-TUNE+® Disable, level triggered (219) Profile Disable, level triggered (206) Profile Hold/Resume, level triggered (207) Start Profile, edge triggered (196) Profile Start/Stop, level triggered (208) Start Step (1077)	None	10003
Function Instance	Function Key (1 to 2) Select which instance the EZ Key will affect. If only one instance is available, any selection will affect it.	0 to 40	0	10004

### Global List

#### Operations — Setup — Global —

Display Units	Select which scale to use for temperature.	°F (30), °C (15)	°F	3005
Language	Select which language to be used on for the display	English (255) German (256) Spanish (259)	English	3037
AC Line Frequency	Set the frequency to the applied ac line power source.	50 Hz (3), 60 Hz (4)	60 Hz	1034
Ramping Type	Select the way the profile intervals change the ramping set point.	Time (143), Rate (81)	Time	22038

## Setup Lists

You will not see every parameter listed here. These vary depending on the features enabled on your device.

Parameter	Description	Range of Options	Default	Parameter ID
Profile Type	Set the profile startup to be based on a set point or a process value.	Set Point (85) Process (75)	Set Point	22008
Guarant. Soak Enable	Guaranteed Soak Enable. Enables the guaranteed soak deviation function in profiles.	Off (62) On (63)	Off	22006
Guarant. Soak Dev. 1	Guaranteed Soak Deviation 1. The value of the deviation band that will be used in all profile step types. The process value must enter the deviation band before the step can proceed.	0.0 to 9,999.000°F or units 0.0 to 5,555.000°C	10.0°F or units 6.0°C	22007
Guarant. Soak Dev. 2	Guaranteed Soak Deviation 2. The value of the deviation band that will be used in all profile step types. The process value must enter the deviation band before the step can proceed.	0.0 to 9,999.000°F or units 0.0 to 5,555.000°C	10.0°F or units 6.0°C	22041
Source Instance A	The DIO source for Wait for Event 1 in a profile.	5 - 12	5	22060
Source Instance B	The DIO source for Wait for Event 2 in a profile.	5 - 12	5	22061
Power Off Time	If profile is running and power is lost, profile resumes where it left off, provided the time the control is off, has not exceeded the Power Off Time value.	0 to 9999 seconds	0	22073
Source Function E	Set the source for profile wait.	Analog Input (142) Digital Bus Input (1993)	Analog Input	22056
Source Instance E	Set the instance of the function selected above.	1 to 6	1	22060
Source Function F	Set the source for profile wait.	Analog Input (142) Digital Bus Input (1993)	Analog Input	22057
Source Instance F	Set the instance of the function selected.	1 to 6	1	22061
Synchronized Variable Time Base ("Sync Var Time Base")	For tighter accuracy when running a profile. A setting of +0.01 equates to approximately +9 seconds/day (faster); a setting of -0.01 equates to approximately -9 seconds/day (slower).	-2 to 2 %	0.00	----
Communications LED Action ("Comms LED Action")	Turns comms indicator on or off for selected comms ports.	Comm port 1 (1189) Comm port 2 (1190) Comm port 1 and 2 (13) Off (62)	both	3014
Zone	Turns Zone indicator on or off based on selection.	Off (62) On (63)	On	3026
Channel	Turns Channel indicator on or off based on selection.	Off (62) On (63)	On	3027
Display Pairs	Defines the number of Display Pairs.	1 to 10	2	3028
Display Time	Time delay in toggling between Display Pairs.	0 to 60	0	3029
Save Settings As	Save all of this controller's settings to the selected set.	None (61) User Set 1 (101) User Set 2 (102)	None	1014
Restore SettingsFrom	Replace all of this controller's settings with another set.	None (61) User Set 1 (101) User Set 2 (102) Factory (31)	None	1013

## Setup Lists

You will not see every parameter listed here. These vary depending on the features enabled on your device.

Parameter	Description	Range of Options	Default	Parameter ID
Bluetooth®	Set the Bluetooth® radio on or off. The Bluetooth® radio can only be turned on via the front panel once turned off.	Off (62) On (63)	On	3048
Home Screen	Set the style and color of the home screen display.	0 Classic, black background 1 Classic, white background 2 Three items, black background 3 Three items, blue background	0 Classic	3076
Key Sensitivity	User adjustable keypad sensitivity.	Low Less Than Factory Greater Than High	Factory	
Timespan	Amount of historical data in time being displayed.	1 hr, 3 hr, 6 hr, 12 hr, 24hr	1 hr	
Y-Axis High Value	Viewable high limit of the chart.	-1999-9999°	9999°	
Y-Axis Low Value	Viewable low limit of the chart.	-1999-9999°	-1999°	

### Communications List

*Operations — Setup — Communications — [Communications 1, Communications 2]*

Protocol	Set the protocol of this controller to the protocol that this network is using.	Standard Bus (1286) Modbus® RTU (1057)	Modbus®	17009
----------	---	---	---------	-------

*Operations — Setup — Communications — [Communications 1, Communications 2]  
Standard Bus —*

Standard Bus Address	Set the network address of this controller. Each device on the network must have a unique address. The Zone Display on the front panel is this number.	1 to 16	1	17001
----------------------	--	---------	---	-------

*Operations — Setup — Communications — [Communications 1, Communications 2]  
Modbus® RTU —*

Modbus® Address	Set the network address of this controller. Each device on the network must have a unique address.	1 to 247	1	17007
Baud Rate	Set the speed of this controller's communications to match the speed of the Modbus® serial network.	9,600 (188) 19,200 (189) 38,400 (190)	9,600	17002
Parity	Set the parity of this controller to match the parity of the Modbus® serial network.	None (61) Even (191) Odd (192)	None	17003
Display Units	Communications (1 or 2) Select whether this communications channel will display in Celsius or Fahrenheit. Note:Applies to Modbus® only.	Fahrenheit (30) Celsius (15)	F	17050

## Setup Lists

You will not see every parameter listed here. These vary depending on the features enabled on your device.

Parameter	Description	Range of Options	Default	Parameter ID
Modbus® Word Order	Communications (1 or 2) Select the word order of the two 16-bit words in the floating-point values.	Low-High (1331) High-Low (1330)	Low-High	17043
Data Map	Communications (1 or 2) If set to 1 the control will use PM legacy mapping. If set to 2 the control will use new mapping to accommodate new functions.	1 to 2	1 if 9th digit of configuration code is a D or 1 otherwise, 2.	17059
Non-Volatile Save	Communications (1 or 2) If set to Yes all values written to the control will be saved in EEPROM. The EEPROM allows for approximately one million writes.	Yes (106) No (59)	Yes	17051

## Setup Lists

You will not see every parameter listed here. These vary depending on the features enabled on your device.

### Operations — Setup — Communications — [Communications 1, Communications 2] DeviceNet —

DeviceNet™ Node Address	Set the DeviceNet™ address for this gateway.	0 to 63	63	17052
DeviceNet™ Baud Rate	Set the DeviceNet speed for this gateway's communications to match the speed of the serial network.	125 kb (1351) 250 kb (1352) 500 kb (1353)	125	17053
DeviceNet Quick Conn	DeviceNet™ Quick Connect Enable . Allows for immediate communication with the scanner upon power up.	No (59) Yes (106)	No	17054
CIP Target2Orig Qty	CIP Implicity Assembly Output Member Quantity	1 to 40	40	24009
CIP Orig2Target Qty	CIP Implicity Assembly Input Member Quantity	1 to 40	40	24010
Display Units	Select which scale to use for temperature passed over communications port 2.	°F (30) °C (15)	°F	17050
Non-volatile Save	If set to Yes all values written to the control will be saved in EEPROM. The EEPROM allows for approximately one million writes.	Yes (106) No (59)	No	17051

### Operations — Setup — Digital Bus (J1939 CAN) —

J1939 Node Address	Set the Device address.	0 to 255	249	94001
J1939 Baud Rate	Set the Digital Input Bus communications speed.	125 kb (1351) 250 kb (1352) 500 kb (1353) 1000 kb (1364)	250	94002
J1939 Device Enable	Enables the device for communication.	No (59) Yes (106)	Yes	94003
TEDS Read Enable	Transducer Electronic Data Sheet. Contains sensor technical characteristics when manufactured.	No (59) Yes (106)	Yes	94004
Display Units	Select which scale to use for temperature passed over communications port 2.	°C (15) °F (30) None (61)	°C	17050

## Setup Lists

You will not see every parameter listed here. These vary depending on the features enabled on your device.

Data Map	If set to 1 the control will use legacy Modbus® mapping. If set to 2, the control will use new Modbus® mapping to accommodate new functions. Not used with J1939.	1 to 2	1	17059
Non-volatile Save	If set to Yes all values written to the control will be saved in EEPROM. The EEPROM allows for approximately one million writes.	Yes (106) No (59)	No	----

### Operations — Setup — Profibus DP —

Profibus Address	Set the Profibus address for this control.	0 to 126	126	17060
Address Lock	When set to yes will not allow address to be changed using software. Can be changed from front panel.	No (59) Yes (106)	No	17061
Status	Profibus DP Status Current Profibus status.	Ready (1662) Running (149)	----	17062
Display Units	Select which scale to use for temperature passed over communications port 2.	°F (30) °C (15)	°F	17050
Non-volatile Save	If set to Yes all values written to the control will be saved in EEPROM. The EEPROM allows for approximately one million writes.	Yes (106) No (59)	No	17051

## Setup Lists

You will not see every parameter listed here. These vary depending on the features enabled on your device.

### Operations — Setup — Modbus® TCP or EtherNet/IP —

Parameter	Description	Range of Options	Default	Parameter ID
Modbus® Word Order	Select the word order of the two 16-bit words in the floating-point values.	Low-High (1331) High-Low (1330)	Low-High	17043
IP Address Mode	Select DHCP to let a DHCP server assign an address to this module.	DHCP (1281) Fixed Address (1284)	DHCP	17012
Note: When changing IP address, the control power must be cycled for the new address to take effect.				
IP Fixed Addr Part1	Set the IP Address of this Module. Each device on the network must have a unique address.	0 to 255	169	17014
IP Fixed Addr Part2	IP Fixed Address Part 2. Set the IP address of this module. Each device on the network must have a unique address.	0 to 255	254	17015
IP Fixed Addr Part3"	IP Fixed Address Part 3. Set the IP address of this module. Each device on the network must have a unique address.	0 to 255	1	17016
IP Fixed Addr Part4	IP Fixed Address Part 4. Set the IP address of this module. Each device on the network must have a unique address.	0 to 255	1	17017
IP Fixed Subnet Prt1	Set the IP subnet mask part 1	0 to 255	255	17020
IP Fixed Subnet Prt2	Set the IP subnet mask part 2	0 to 255	255	17021
IP Fixed Subnet Prt3	Set the IP subnet mask part 3	0 to 255	0	17022
IP Fixed Subnet Prt4	Set the IP subnet mask part 4	0 to 255	0	17023
IP Fixed Subnet Prt5	Set the IP subnet mask part 5	0 to 255	0	17024

## Setup Lists

You will not see every parameter listed here. These vary depending on the features enabled on your device.

IP Fixed Subnet Prt6	Set the IP subnet mask part 6.	0 to 255	0	17025
Fixed IP Gateway Part 1	Used for the purpose of sending and receiving messages from another network.	0 to 255	0	17026
Fixed IP Gateway Part 2	Used for the purpose of sending and receiving messages from another network.	0 to 255	0	17027
Fixed IP Gateway Part 3	Used for the purpose of sending and receiving messages from another network.	0 to 255	0	17028
Fixed IP Gateway Part 4	Used for the purpose of sending and receiving messages from another network.	0 to 255	0	17029
Fixed IP Gateway Part 5	Used for the purpose of sending and receiving messages from another network.	0 to 255	0	17030
Fixed IP Gateway Part 6	Used for the purpose of sending and receiving messages from another network.	0 to 255	0	17031
Modbus <sup>®</sup> TCP Enable	Activate Modbus <sup>®</sup> TCP.	Yes (106) No (59)	Yes	17041
EtherNet/IP <sup>™</sup> Enable	Activate Ethernet/IP <sup>™</sup> .	Yes (106) No (59)	Yes	17042
EtherNet/IP <sup>™</sup> Output Assembly (" CIP Target2Orig Qty")	When using EtherNet/IP set the CIP Implicit Assembly Output Member Quantity	1 to 40	40	24009
EtherNet/IP <sup>™</sup> Input Assembly (" CIP Orig-2Target Qty")	When using EtherNet/IP set the CIP Implicit Assembly Input Member Quantity	1 to 40	40	24010

## Setup Lists

You will not see every parameter listed here. These vary depending on the features enabled on your device.

Parameter	Description	Range of Options	Default	Parameter ID
Display Units	Select the scale for temperature passed over communications port 2.	°F (30) °C (15)	°F	17050
Non-volatile Save	If set to Yes all values written to the control will be saved in EEPROM. The EEPROM allows for approximately one million writes.	Yes (106) No (59)	No	17051

Note: When changing IP address, the control power must be cycled for the new address to take effect.



# Changing PM PLUS™ to PM PLUS™ Express

You can disable advanced features of the PM PLUS™ by enacting PM PLUS™ Express mode. The PM PLUS™ Express mode allows your users simplified operations.

PM PLUS™ Express Impact on Functionality										
Digit of Configuration Code	1 2	3	4	5	6 7	8	9	10 11	12	13 14
	Controller	Package Size	Primary Function	Power Supply	Output 1 & 2	Communications or DIO	Auxilliary	Outputs 3 & 4	Additional Options	Custom
Write your device's configuration code										
Device Configuration code	P M	6,8,9	[C R T J N S]	1 2 3 4	CA CH CC CJ CK EA EH EC EJ EK FA FC FJ FK AK KH KK	A B E F G H J	A R P T L M	AA AJ AK CA CC CJ CK EA EC EJ EK FA FC FJ FK KK	P V	WP WN AG
Effect of Enacting PM PLUS™ Express	No change	No change	If [C R T], EXPRESS is C If [J N S], EXPRESS is J	If [1 2], EXPRESS is 1 If [3 4], EXPRESS is 3	No change to original configuration	No longer available	No longer available	No longer available	X	No change to original configuration

## How to Enact PM PLUS™ Express

Before enacting PM PLUS™ Express, note that optional hardware may no longer work even if installed. Refer to the table "PM PLUS™ Express Impact on Functionality."

1. Navigate to **Operations — Factory — Calibration**.
2. Scroll to select **Public Key**.
3. You will see the number **4999**.
4. Change to **2501** to switch to EXPRESS.

## Revert from PM Express Menu to Original Configuration

To revert to your original configuration, reset the device to the original configuration code as seen on the product label on your device. Reverting to the original configuration will re enable any optional hardware installed and configured to work with PM PLUS.

1. Go to **Operations — Factory — Calibration**.
2. Scroll to select **Model State Code**.
3. Change the 4999 to **606** to switch back to your purchased configuration.

---

# Saving and Restoring Settings

You can save two sets of settings on the PM PLUS. We recommend that you program the device, then verify proper operation, then save the settings to the device memory.

## Saving Settings to Device Memory

1. Go to **Operations — Setup — Global — Save Settings As**
2. Select User Set 1 or User Set 2. You can save two sets of configurations.
3. Saving the settings overwrites any previously saved collection of settings. Be sure to document all the controller settings.
4. If the settings in the controller are altered you can return the controller to one of three settings: Set 1, Set 2, or Factory. Navigate to the Setup - Global to find the Restore SettingsFrom prompt.
5. A digital input or the Function Key can also be configured to restore parameters.

## Reset Original Factory Settings

This sets all default configurations as shipped from the factory, according to your purchased configurations.

1. Go to **Operations — Setup — Global — Restore SettingsFrom**.
2. Scroll to and select **Factory**. 
3. When restoring factory defaults, I/O assemblies for Modbus®, DeviceNet, Profibus and Ethernet along with the zone address will be overwritten.

The unit will reset after a restore from Factory is selected.

This reset only affects available defaults within the current configuration of the device.

---

# Trending Screen Setup

1. Go to programming function key instructions in **Operations—Setup—Function Key**, to first setup a function key for toggling the Trending Key.
2. Press the **Home** screen. Use the right arrow key go to **Operations—Setup — Global**.
3. Choose length of time to display. Go to **Setup —Global — Timespan** —use the right arrow key to navigate into the time selection menu.
4. Next, set the highest degrees you wish to view. Go to **Setup —Global — Y-Axis High Value** —use the right arrow key to move into the adjustment screen. Use the “+” of “-“ on the interface to make your adjustment.
5. Lastly, you will set the lowest degrees you wish to view. Go to **Setup —Global — Y-Axis Low Value** —use the right arrow key to move into the adjustment screen.
6. Press **Home** key to return to the home screen.
7. Press the **Function** key, the trending screen should appear. Pressing the Function key again will return you to the Home screen.

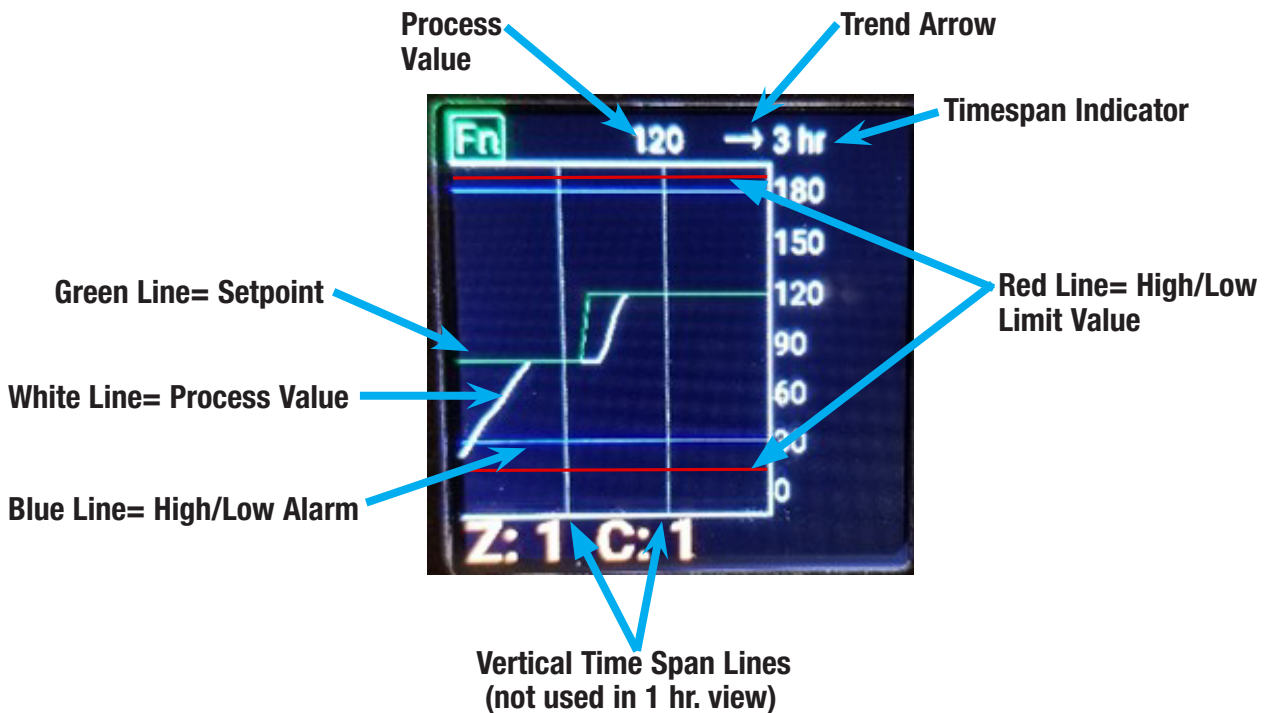

# Chapter 6: Profiles

You can configure up to four profiles in the PM PLUS. Once configured, you can start any of the four profiles manually from the Operations - Profile list. You may wish to configure the function key to start a specific profile, or set up a DIO to start a profile.

---

## Setting Up Global Features

Some feature settings, once configured, apply to all profiles, e.g. if Guaranteed Soak is not enabled in the Global List, this feature will not be available in any individual profile. These parameters apply to all profiles:

You must set up the globally applicable parameter settings prior to setting up individual profiles.

1. Navigate to **Operations — Setup — Global**
2. Select a parameter using the right arrow key, and select the desired option for that parameter. After selecting the parameter, press the left back arrow to return to the Global List and choose the next parameter so you can configure its options.
  - Ramping Type can be Time or Rate, and defaults to Time. If set to time, the set point is ramped according to the time interval selected (hours minutes, seconds). If set to rate, the set point is ramped by degrees/units per minute.
  - Profile Type can be Set Point or Process. This determines whether a step changing the set point of a profile begins using the last closed-loop set point (Set Point). or the process value (Process)
  - Guaranteed Soak Enable, when set to on is available in all profiles. If Guaranteed Soak Enable is on, use Guaranteed Soak Deviation 1 to 2 for the corresponding loop. Set the deviation or band above or below the working set point where this condition must be met before the profile can proceed.
  - Source Instance A and Source instance B refer to DIO 5 through 12, and are used in "Wait for Event" steps.
3. Press the Home icon to exit all Lists.

After the global profile features are configured, you can set up to four profiles.

---

## Setting Up Profiles

After the Global features have been set up, you may set up Profile 1, then Profile instances [2,3,4].

1. Go to **Operations — Profile — Profile 1 Step — Profile 1 Step 1 —**
2. Select **Step Type**. Scroll to the desired Step Type and press right arrow to select. We recommend **Time** as the first Step Type.
  - Unused Step (50)
  - Soak (87)
  - Wait for Event (144)
  - Wait for Process (209)
  - Wait for Both (210)

- Jump (116)
  - End (27)
  - Time (143)\*
  - Ramp Rate (81)\*
3. It will advance to the Target Set Point for Loop 1. Enter this set point value, and press the right arrow key. It will advance to the Target Set Point for Loop 2; if it has 2 Control Loops. Enter this set point value, and press the right arrow key.
  4. Now Hours is displayed, and enter the hours value, then press the right arrow. Continue to press the right arrow key, and enter the minutes value, and then the seconds value. This Time Step defines what the Set Point will ramp to in the time duration that was entered.
  5. Press the right arrow key, and select whether the Event 1, should be "Off" or "On". Note - One of the Outputs on this PM should have already been programmed in the Setup/Output menu as Profile Event A, for this function to be applicable. If it was not programmed, then leave this Event 1 "Off".
  6. Press the right arrow key, and select whether the Event 2, should be "Off" or "On". Note - One of the Outputs on this PM should have already been programmed in the Setup/Output menu as Profile Event B, for this function to be applicable. If it was not programmed, then leave this Event 2 "Off".
  7. Press the left back arrow to return to the Profile 1 List of Steps, then repeat steps 2 and 3 for each of the Profile Steps.

---

## Starting a Profile

There are three ways to start a profile:

- Configure the Function Key to start a profile
- Configure a Digital Input to start a profile (check the configuration of your control to confirm that you have a DIO option)
- Manually start a profile from the Operations — Profile.

## Configuring the Function Key to Start and Stop a Profile

1. Navigate to the **Operations — Setup -Function Key**.
2. Select Action Function.
3. Select either **Start Profile** or **Profile Start/Stop**.
  - With Start Profile, the function key will start a profile only.
  - With Profile Start/Stop, one press of the function key starts the selected profile and the next press stops it.
4. Press Right Arrow Key and **Function Instance** will appear.
5. Use the numeric slider or +/- keys to select the Profile number, (1,2,3 or 4), that you want to start.
6. Return to the Home Screen by pressing the home icon.

## Configuring a Digital Input to Start and Stop a Profile

1. Navigate to **Operations — Setup - Digital I/O** menu.
2. Select either Digital I/O 5.
3. Select the Input type - Voltage or Dry Contact.
4. Select Action Function.
5. Select either **Start Profile** or **Profile Start/Stop**.

- With Start Profile, toggling the D I/O, will start a profile only.
  - With Profile Start/Stop, toggling the D I/O, starts the selected profile and the next state change on the D I/O, stops it.
6. Press Right Arrow Key and set **Function Instance** to the number, (1,2,3 or 4), that you want to start.
  7. Return to the Home Screen by pressing the home icon.

### Starting a Profile from the Operations List

1. Navigate to **Operations — Profile Status**.
2. Select **Profile Start**.
3. Select the Profile or Step to start.
4. Select the **Profile Action Request**.
5. Select **Profile** to start the Profile from its first step.
6. Return to the Home Screen by pressing the Home icon.

### Ending a Profile from the Operations List

1. Navigate to **Operations — Profile Status**.
2. Scroll to select the Profile Action Request. Scroll to select the **End**.
3. Return to the Home Page by pressing the Home icon.

## Profile List

Profile List Parameters				
<i>Operations — Profile —</i>				
Display	Parameter Name Description	Range	Default	ID
Profile 1 Step Profile 2 Step Profile 3 Step Profile 4 Step	Profile [1 to 4] Step Select a profile to edit or view.	1 to 10 [profile 1] 11 to 20 [profile 2] 21 to 30 [profile 3] 31 to 40 [profile 4]		----
Step Type	Select a step type. (See Profile Step Types table). *Note: Profiles may be based on time or rate of change, as defined in the Global List. By default, profiles are configured for Time, so Rate is not available here by default. If it is desired to base profiles on rate of change, go to Setup - Global and change the Ramping Type from Time to Rate.	Unused Step (50) Soak (87) Wait For Event (144) Wait For Process (209) Wait For Both (210) Jump (116) End (27) Time (143)* Ramp Rate (81)*	Unused	21001
Target Set Point Loop 1	When Step Type is Time or Rate, enter the closed loop set point for loop 1 to ramp to for this step.	-1,999.000 to 9,999.000°F or units -1,128 to 5,537.000°C	0.0°F or units -18°C	21002

## Profile List Parameters

### Operations — Profile —

Display	Parameter Name Description	Range	Default	ID
Target Set Point Loop 2	When Step Type is Time enter the closed loop set point for loop 2 to ramp to for this step.	-1,999.000 to 9,999.000°F or units -1,128 to 5,537.000°C	0.0°F or units -18°C	21028
Hours	Select the hours (plus Minutes and Seconds) for a timed step, i.e. Time, Soak, or Wait for Time..	0 to 9999	0	21003
Minutes	Enter Minutes (plus Hours and Seconds) for a timed step, i.e. Time, Soak, or Wait for Time.	0 to 59	0	21004
Seconds	Enter Seconds (plus Hours and Minutes) for a timed step, i.e. Time, Soak, or Wait for Time.	0 to 59	0	21005
Rate	When Step Type is Rate, enter the rate for ramping in degrees or units per minute.	0 to 9,999.000°F or units per minute 0 to 5,555.000°C per minute	0.0	21006
Wait For Process	Enter the analog input specified by Wait For Process 1 that must be met in a Wait for Process or Wait for Both step before proceeding in profile.	1 or 2	1	21015
Wait For Process 1	Enter wait for process value on analog input specified by Wait For Process Instance in a Wait for process or Wait for Both step before proceeding.	-1,999.000 to 9,999.000°F or units -1,128.000 to 5,537.000°C	0.0°F or units -18.0°C	21011
Wait Event 1	Select the event state that must be satisfied during a Wait for Event or Wait for Both step. Wait Event 1 is mapped to DIO 5.	Off (62) On (63) None (61)	Off	21009
Wait Event 2	Select the event state that must be satisfied during a Wait for Event or Wait for Both step. Wait Event 2 is mapped to DIO 6.	Off (62) On (63) None (61)	Off	21010
Jump Step	When Step Type is Jump, this specifies which step to jump back to. Jump Step must be a lower step number than the current step number.	1 to 40	0	21012
Jump Count	When Step Type is Jump, this specifies the number of jumps to repeat. A value of 0 creates an infinite loop. Loops can be nested four deep.	0 to 9,999	0	21013
End Type	When Step Type is End, this specifies what the controller will do when this profile ends.	Off Control Mode set to Off (62) Hold Hold last closed-loop set point in the profile (47) User User, reverts to previous set point (100)	Off	21014
Event 1	Regardless of Step Type, select whether Event Output 1 or 2 is on or off during this step.	Off (62) On (63)	Off	21007
Event 2	Regardless of Step Type, select whether Event Output 1 or 2 is on or off during this step.	Off (62) On (63)	Off	21008

## Profile Step Types

Step Types	Description	Parameters in Step Type
Unused Step	This is an empty step that can be used to plan for future steps to be inserted.	- - - -
Soak	A Soak Step maintains the last Target Set Points for the designated time. The state of up to 2 event outputs may be set or maintained.	Hours Minutes Seconds Event 1 Event 2
Wait For Event	A Wait for Event Step waits for the two Wait for Event states (1 to 2) to match the specified state. The state of up to 2 event outputs may be set or maintained.	Wait Event 1 Wait Event 2 Event 1 Event 2
Wait For Process	A Wait for Process Step will wait for Process Value 1 or 2 to match the Wait for Process Value. The state of up to 2 event outputs may be set or maintained.	Event 1 Event 2
Wait For Both	A Wait For Process and Event Step will wait for Process Value 1 or 2 to match the Wait for Process 1 value, and/or the two Wait Event states to match the specified state. The state of up to 2 event outputs may be set or maintained.	Wait Event 1 Wait Event 2 Event 1 Event 2
Jump	A Jump step will repeat previous steps a number of times designated in Jump Count. Jumps can be nested up to four deep. The state of up to 2 event outputs may be set or maintained.	Jump Step Jump Count Event 1 Event 2
End	An End Step will end the profile and set the control modes and set points to match the End Type. The state of up to 2 event outputs may be set or maintained. The event outputs will not be set off unless specifically stated in this step. If a profile does not have an End Step, the profile continues until step 40, then stops and maintains the last set points and control modes.	End Type Event 1 Event 2
Time	If Ramping Type in Setup - Global is set for Time, the control loop will follow set point over the specified time. If two loops of control are present then they will both follow independent set points over the specified time. The state of up to 2 event outputs may be set or maintained.	Target Set Point Loop 1 Target Set Point Loop 2 Hours Minutes Seconds Event 1 Event 2
Ramp Rate	If Ramping Type found in the Global Menu of the Setup Page is set for Rate, specify the rate of change in degrees or units per minute. The state of up to 2 event outputs may be set or maintained. Note - Ramp rate as a Step Type is only available on single loop controllers.	Target Set Point Loop 1 Rate Event 1 Event 2



# Chapter 7: Factory List

These parameters vary depending on the configuration of your device. You may not see all parameters listed here. If there is only one instance of a menu, no submenus will appear.

Factory List				
Display	Parameter Description	Range	Default	Parameter ID
<i>Operations — Factory — Custom Setup</i>				
Custom Setup [1 to 20]	Select the parameters that appear on the Home Screen. Parameter 1 is displayed on the bottom of the Home Screen and cannot be changed with the numeric slider or +/- keys. Parameter 2 value is the larger display on the Home Screen. It can be changed with the numeric slider and +/- keys, if the parameter is a writable one.	None Process Calibration Offset Display Units Restore Settings From Alarm Low Set Point Alarm High Set Point Alarm Hysteresis Set Point Active Process Value Active Set Point Open-Loop Set Point Autotune Control Mode Heat Power Cool Power Time Integral Time Derivative Dead Band Heat Proportional Band On/Off Heat Hysteresis Cool Proportional Band On/Off Cool Hysteresis Ramp Rate TRUE-TUNE+ Enable Idle Set Point Profile Start Profile Action Request Current Step Step Type Target Set Point Loop 1 Target Set Point Loop 2 Active Set Point Produced Set Point 2 Hours Minutes Seconds Guaranteed Soak Deviation 1 Event 1 Event 2 Jump Count Remaining Low Limit Set Point High Limit Set Point Limit Hysteresis Limit Status Control Mode Active Custom		14005

## Factory List

Display	Parameter Description	Range	Default	Parameter ID
Instance ID	Select which instance of the selected parameter is referenced. This only displays if you are configuring a parameter that applies to multiple instances.	1 to 4		14003
<b>Operations — Factory — Lock —</b>				
Operations	Change the security level of the Operations List.	1 to 3	2	3002
Profiling	Change the security level of the Profiling List.	1 to 3	3	3008
Password Enable	Set to On to require a password for menu changes.	Off On	Off	3009
Read Lock	Set the Read security level. The user can access the selected level and all lower levels. If the Set Lockout Security level is higher than the Read Lockout Security, the Read Lockout Security level takes priority.	1 to 5	5	3010
Set Lock	Set the set/write security level. The user can access the selected level and all lower levels. If the Set Lockout level is higher than the Read Lockout, the Read Lockout level takes priority.	0 to 5	5	3011
Locked Access Level	Determines user level menu visibility when Password Enable is set to on.	1 to 5	5	3016
Rolling Password	When power is cycled a new Public Key is displayed and User Password changes.	Off On	Off	3019
User Password	Used to acquire access to menus made available through the Locked Access Level setting.	10 to 999	63	3017
Administrator Password	Used to acquire full access to all menus including disabling or changing passwords.	10 to 999	156	3018
<b>Operations — Factory — Unlock —</b>				
This only appears if security has been set up in the Lock list previously				
Public Key	If Rolling Password is on, the public key is a new random number each time power is cycled. If Rolling Password is off, a fixed number is displayed. The key is used to gain access when password is unknown.	Customer Specific	0	3020
Password	Enter the User or Administrator password to gain access. After valid password is supplied exit this menu and re-enter the Security Menu via the Factory Page.	-1999 to 9999	0	3022
<b>Operations — Factory — Diagnostics —</b>				
Part Number	Display this controller's part number.	15 characters	----	1009
Software Revision	Display this controller's firmware revision number.	1 to 10	----	1003
Software Build Number	Display the firmware build number.	0 to 2,147,483,647	----	1005
Serial Number	Display the serial number.	0 to 2,147,483,647	----	1032
Manufacture Date	Display the date code (YYWW). Where YY = year and WW= week.	0 to 2,147,483,647	----	1008
IP Address Mode	Actual address mode (DHCP or Fixed).	DHCP (1281) Fixed Address (1284)	DHCP	17038
IP Actual Address Part 1	Actual IP address of this module. Note: This is read only. Go to <b>Operations — Setup — Communications</b> to change.	0 to 255	169	17044

## Factory List

Display	Parameter Description	Range	Default	Parameter ID
IP Actual Address Part 2	Actual IP address of this module. Note: This is read only here. Go to <b>Operations — Setup — Communications</b> to change.	0 to 255	254	17045
IP Actual Address Part 3	Actual IP address of this module. This is a read only parameter here. Go to <b>Operations — Setup — Communications</b> to change.	0 to 255	1	17046
IP Actual Address Part 4	Actual IP address of this module. Note: This is read only here. Go to Setup - Communications to change.	0 to 255	1	17047
<b>Operations — Factory — Calibration —</b> You may see Calibration 1, Calibration 2, or Calibration 3, depending on the configuration of your device.				
Electrical Measurement	Read the raw electrical value for this input in the units corresponding to the Sensor Type setting in <b>Setup - Analog Input</b> .	-3.4e38 to 3.4e38		4021
Electrical Input Offset	Change this value to calibrate the low end of the input range.	-1,999.000 to 9,999.000	0.0	4010
Electrical Input Slope	Adjust this value to calibrate the slope of the input value.	-1,999.000 to 9,999.000	1.0	4011
Electrical Output Offset	Change this value to calibrate the low end of the output range.	-1,999.000 to 9,999.000	0.0	18005
Electrical Output Slope	Adjust this value to calibrate the slope of the output value.	-1,999.000 to 9,999.000	1.0	18006
Part Number	Displays current setting for control model number.	Factory User	Factory	----
Public Key	Changes the control to user mode or back to original configuration/model number.	2501 = User Settings 606 = Factory model number	4999	----

# Chapter 8: Features

## Autotune

When an autotune is performed on the PM PLUS™ the set point and the autotune set point are used to calculate the tuning set point. For example, if the active set point is 200° and Autotune Set Point is 90 percent, the autotune function uses 180° for tuning.

Autotuning calculates the optimum heating and/or cooling PID parameter settings based on the system's response. The PID settings generated by the autotune will be used until the autotune feature is rerun, the PID values are manually adjusted or TRU-TUNE+ is enabled.

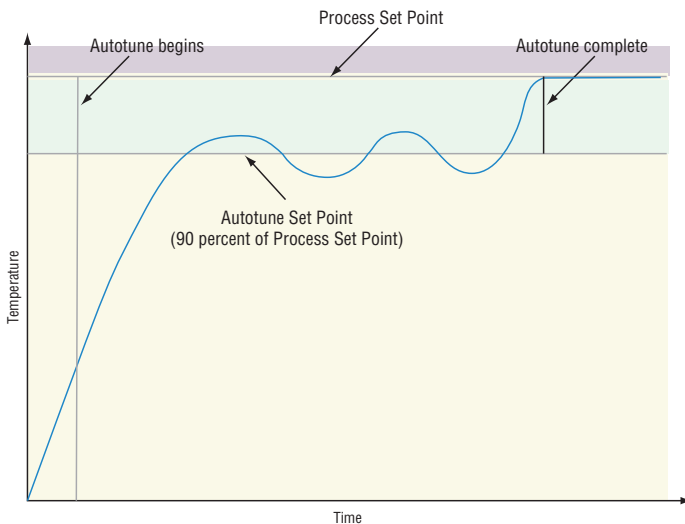

### Start Autotune

1. Use the slider or +/- keys to set the set point for the tune.
2. Navigate to: **Operations - Autotune 1, (or Autotune 2 if autotuning loop 2).**
3. Scroll to select **Yes**.
4. Press the Home icon to return to the Home Screen.

#### WARNING!

During autotuning, the controller sets the output to 100 percent and attempts to drive the Process Value toward the set point. Enter a set point and heat and cool power limits that are within the safe operating limits of your system.

### Manual Tuning

In some applications, the autotune process may not provide PID parameters for the process characteristics you desire. If that is the case, you may want to tune the controller manually.

1. Apply power to the controller and use the numeric slider or the +/- keys to select a set point for your process.

2. Navigate to **Operations — Setup - Control Loop**, then scroll to and select Heat Proportional Band **Heat Prop. Band** and/or Cool Proportional Band **Cool Prop. Band**, then use the numeric slider or +/- keys to change the value to **25**.
3. Press the Left Back Arrow to return to the Control Loop List, then scroll to and select **Time Integral**, then use the numeric slider or +/- keys to change the time integral to **0**.
4. Press the Left Back Arrow to return to the Control Loop List, then scroll to and select **Time Derivative**, then use the numeric slider or +/- keys to change the time derivative to **0**.
5. When the system stabilizes, watch the process value. If it fluctuates, double the Heat Proportional Band or Cool Proportional Band value until it stabilizes, allowing time for the system to settle between adjustments.
6. When the process has stabilized, open **Operations — Monitor** and watch Heat Power or Cool Power. It should be stable. At this point, the process temperature should also be stable, but it will have stabilized before reaching the set point.
7. The difference between the set point and actual process value can be eliminated with Integral.
8. Start with an Integral value of 6,000 and allow 10 minutes for the process temperature to reach the set point. If it has not, reduce the setting by half and wait another 10 minutes. Continue reducing the setting by half every 10 minutes until the process value equals the set point. If the process becomes unstable, the Integral value is too small. Increase the value until the process stabilizes.

## TRU-TUNE+®

The TRU-TUNE+ adaptive algorithm optimizes the controller's PID values to improve control of dynamic processes. TRU-TUNE+ monitors the Process Value and adjusts the control parameters automatically to keep your process at set point during set point and load changes. When in adaptive control mode, the controller determines the appropriate output signal and, over time, adjusts control parameters to optimize responsiveness and stability. The TRU-TUNE+ feature does not function for on-off control.

The preferred and quickest method for tuning a loop is to establish initial control settings and continue with the adaptive mode to fine tune the settings. Setting Control Mode to tune starts this two-step tuning process. This predictive tune determines initial, rough settings for the PID parameters. Then the loop automatically switches to the adaptive mode which fine tunes the PID parameters.

Once the Process Value has been at set point for a suitable period (about 30 minutes for a fast process to roughly two hours for a slower process) and if no further tuning of the PID parameters is desired or needed, TRU-TUNE+™ may be turned off. However, keeping the controller in the adaptive mode allows it to automatically adjust to load changes and compensate for differing control characteristics at various set points for processes that are not entirely linear.

Once the PID parameters have been set by the TRU-TUNE+ adaptive algorithm, the process, if shut down for any reason, can be restarted in the adaptive control mode.

Enable TRU-TUNE+ only after autotune is complete. TRU-TUNE+ should be disabled before autotune is initiated.

## Turn TRU-TUNE+ on or off

1. Navigate to **Operations — Setup - Control Loop**.
2. Select TRU-TUNE Enable
3. Scroll to select **No** or **Yes**.

Enable TRU-TUNE+ only after autotune is complete. It should be disabled before autotune is initiated.

## Set the TRU-TUNE+ Band or Range

1. Navigate to **Operations — Setup - Control Loop**
2. Scroll to and Select **TRU-TUNE+ Band**
3. Set the range above and below the set point in which adaptive tuning will be active. Adjust this parameter only in the unlikely event that the controller is unable to stabilize at the set point with TRU-TUNE+ Band set to auto (0). This may occur with very fast processes. In that case, set TRU-TUNE+ Band to a large value, such as 100.

## Adjust Responsiveness of TRU-TUNE Adaptive Tuning

1. Navigate to **Operations — Setup - Control Loop**
2. Scroll to and select **TRU-TUNE+ Gain**
3. Select the setting desired. Settings range from 1: the most aggressive response and most potential overshoot (highest gain), to 6: the least aggressive response and least potential for overshoot (lowest gain). The default setting, 3, is recommended for loops with thermocouple feedback and moderate response and overshoot potential.

---

# Input Features

## Calibration Offset

Calibration offset allows a device to compensate for an inaccurate sensor, lead resistance or other factors that affect the input value. A positive offset increases the input value, and a negative offset decreases the input value. The input offset value can be viewed or changed with Calibration Offset (**Operations — Setup - Analog Input**).

Before performing any calibration procedure, verify that the displayed readings are not within published specifications by inputting a known value from a precision source to the analog input. Next, subtract the displayed value with the known value and compare this difference to the published accuracy range specification for that type of input.

## Use Calibration Offset

Use of the Calibration Offset parameter shifts the readings across the entire displayed range by the offset value. Use this parameter to compensate for sensor error or sensor placement error. Typically this value is set to zero.

1. Navigate to **Operations — Setup - Analog Input - Calibration Offset**
2. Set the offset to the desired value.

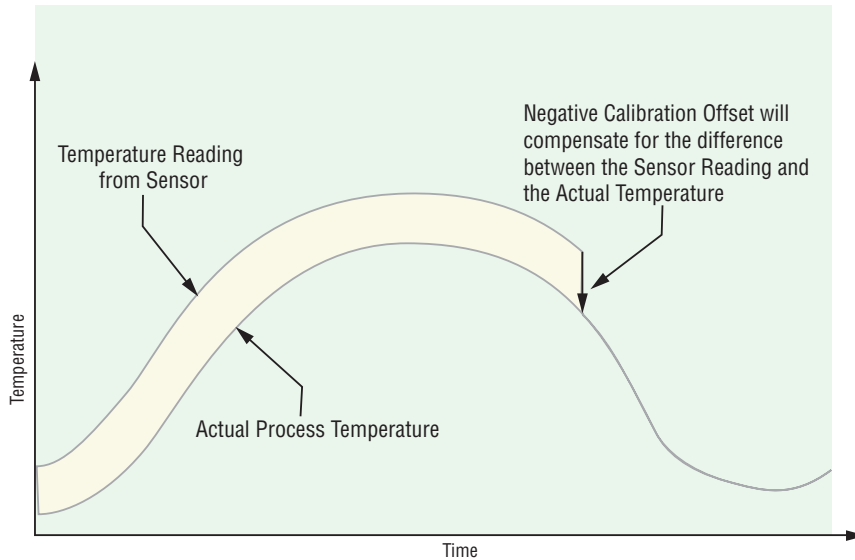

### Equipment required while performing calibration:

Obtain a precision source for millivolts, volts, milliamperes or resistance depending on the sensor type to be calibrated. Use copper wire only to connect the precision source to the controller's input. Keep leads between the precision source and controller as short as possible to minimize error. In addition, a precision volt/ohm meter capable of reading values to 4 decimal places or better is recommended. Prior to calibration, connect this volt/ohm meter to the precision source to verify accuracy. Actual input values do NOT have to be exactly the recommended values, but it IS critical that the actual value of the signal connected to the controller be accurately known to at least four digits.

# Calibration of Analog Inputs

To calibrate an analog input, you will need to provide a source of two electrical signals or resistance values near the extremes of the range that the application is likely to utilize. See recommended values below:

Sensor Type	Precision Source Low	Precision Source High
thermocouple	0.000 mV	50.000 mV
millivolts	0.000 mV	50.000 mV
volts	0.000V	10.000V
milliamps	0.000 mA	20.000 mA
100 $\Omega$ RTD	50.00 $\Omega$	350.0 $\Omega$
1,000 $\Omega$ RTD	500.0 $\Omega$	3,500 $\Omega$
thermistor 5 k $\Omega$	50.00	5,000
thermistor 10 k $\Omega$	150.0	10,000
thermistor 20 k $\Omega$	1,800	20,000
thermistor 40 k $\Omega$	1,700	40,000
potentiometer	0.000	1,200

You may only calibrate one sensor type. If the calibrator interferes with open thermocouple detection, set Sensor Type to **millivolt** instead of **Thermocouple** to avoid interference between the calibrator and open thermocouple detect circuit for the duration of the calibration process. Be sure to set sensor type back to the thermocouple type utilized.

To select the sensor type go to **Operations — Setup — Analog Input — Sensor Type**.

The Electrical Measurement value is in the units selected. I.E. - millivolts, volts, milliamps, or ohms.

## Calibrating Analog Inputs

1. Disconnect the sensor from the controller.
2. Record the Calibration Offset parameter value from **Operations — Setup — Analog Input — Calibration Offset**, then set that value to zero.
3. Wire the precision source to the appropriate controller input terminals to be calibrated. Do not have any other wires connected to the input terminals. Please refer to [Installation and Wiring](#).
4. Ensure the controller sensor type is programmed to the appropriate Sensor Type to be utilized in **Operations — Setup — Sensor Type**.
5. Enter **Operations — Factory — Calibration** and select the Calibration input instance to be calibrated. This corresponds to the analog input to be calibrated.
6. Set **Electrical Input Slope** to 1.000 and **Electrical Input Offset** to 0.000 (this will cancel any prior user calibration values).
7. Set the Precision Source to the low value on your external calibrator. Read Electrical Measurement value of controller at **Operations — Factory - Calibration — Electrical Measurement**. This will be referred to as Electrical Measured Low.



Record the low value \_\_\_\_\_

- Set the Precision Source to the High value on your external calibrator. Read Electrical Measurement value of controller at **Operations — Factory — Calibration — Electrical Measurement**. This will be referred to as Electrical Measured High. Record high value \_\_\_\_\_.
- Calculate the Electrical Input Slope = (Precision High – Precision Low) / (Electrical Measured High - Electrical Measured Low)

Calculated Slope value \_\_\_\_\_

- Calculate the Electrical Input Offset = Precision Low - (Electrical Input Slope \* Measured Low)

Calculated Offset value \_\_\_\_\_

- Enter the calculated Electrical Input Slope and Electrical Input Offset into the controller **Operations — Factory — Calibration — Electrical Input Offset**, then **Operations — Factory — Calibration — Electrical Input Slope**.
- Press the Home Icon to exit.
- Validate the calibration process using a calibrator to the analog input.
- Enter calibration offset as recorded in step 2 if required to compensate for sensor error.

Setting Electrical Input Slope to 1.000 and Electrical Input Offset to 0.000 restores factory calibration.

## Filter Time Constant

Filtering smooths an input signal by applying a first-order filter time constant to the signal. Filtering the displayed value makes it easier to monitor. Filtering the signal may improve the performance of PID control in a noisy or very dynamic system.

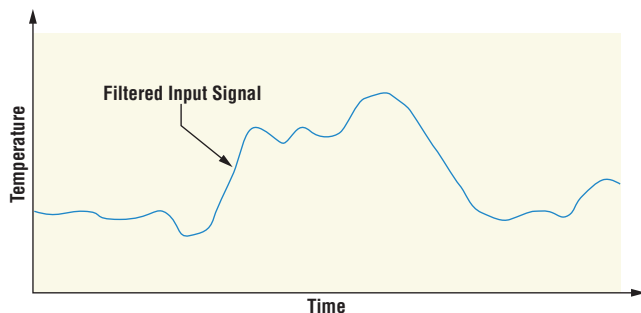
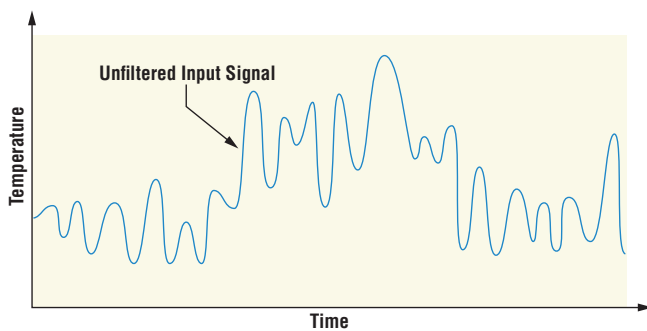

### Adjust the filter time interval

1. Navigate to **Operations — Setup - Analog Input - Filter**
2. Select the filter time interval. Example: With a filter value of 0.5 seconds, if the process input value instantly changes from 0 to 100 and remained at 100, the display will indicate 100 after five time constants of the filter value or 2.5 seconds.

## Sensor Backup

The sensor backup feature is only available in PM PLUS™ Integrated Limit or Remote Set Point controllers. Check your product label to confirm that the configuration code shows L or M in the 9th digit: P M 6 \_ \_ \_ \_ \_ [L,M] \_ \_ \_ \_ \_

Sensor backup maintains closed-loop control after an input failure by switching control to input 2.

### Turn sensor backup on or off

1. Go to **Operations — Setup — Analog Input 1 — Sensor Backup — [Off/On]**
2. Scroll to Off or On, press right arrow to select your choice.
3. Press the Home icon to exit.

When Sensor Backup is enabled the Process Value function automatically sets itself to Sensor Backup.

## Set Minimum Set Point and Maximum Set Point

Set the minimum set point and maximum set point for the preferred mode of operation:

- Closed loop control
- Manual Power (open loop control)
- Limit, as part of an integrated control

Go to **Operations — Setup — Control Loop —** to enter the Minimum Set Point and Maximum Set Point.

## Scale High and Scale Low

When an analog input is selected as process voltage or process current input, you must choose the low and high values of voltage or current. For example, when using a 4 to 20 mA input, the scale low value would be 4.00 mA and the scale high value would be 20.00 mA. Commonly used scale ranges are: 0 to 20 mA, 4 to 20 mA, 0 to 5V, 1 to 5V and 0 to 10V.

You can create a scale range representing other units for special applications. You can reverse scales from high values to low values for analog input signals that have a reversed action. For example, if 50 psi causes a 4 mA signal and 10 psi causes a 20 mA signal.

Scale low and high values do not have to match the bounds of the measurement range. These along with range low and high provide for process scaling and can include values not measurable by the controller. Regardless of scaling values, the measured value will be constrained by the electrical measurements of the hardware.

Go to **Operations — Setup — Analog Input —** to select the desired values for **Scale Low** and **Scale High**.

## Range High and Range Low

With a process input, you must choose a value to represent the low and high ends of the current or voltage range. Choosing these values allows the controller's display to be scaled into the actual working units of measurement. For example, the analog input from a humidity transmitter could represent 0 to 100 percent relative humidity as a process signal of 4 to 20 mA. Range Low would be set to 0 to represent 4 mA and Range High set to 100 to represent 20 mA. The indication on the display would then represent percent humidity and range from 0 to 100 percent with an input of 4 to 20 mA.

Go to **Operations — Setup — Analog Input** — to select the desired values for **Range Low** and **Range High**.

## Remote Set Point via an Analog Signal

A remote set point can be generated with an analog signal on input 2. This analog signal can be a thermocouple, RTD, 1 k potentiometer or process signal at input 2 to establish the set point. A common application would use one ramping controller with a set point retransmit output to ramp multiple controllers using the remote set point. Or you could use an analog output from a PLC to send set point values to a PM PLUS.

1. Select the Remote Set Point Type by going to **Operations — Setup — Control Loop — Remote Set Point — Yes**. (If **No**, the keypad is the active set point, and you can press Home to exit this setup list).
2. The Remote Set Point Type parameters will display. Select Auto or manual
  - If Auto, when Control Mode is Auto, the remote set point/analog input 2 is the active set point
  - If manual, then when the control mode is manual, the remote set point is the percentage of power
3. Set Digital Input 5 or 6 with the function of switching to the remote set point by going to **Operations — Setup — Digital I/O — Digital I/O [5,6] — Direction — Input Dry Contact — Active Level — High — Action Function — Remote Set Point — Function Instance – 1**.
  - For this to function properly, ensure the following is set in **Operations — Setup — Control Loop**
    - **Remote Set Point** must be **No**
    - **Remote Set Point Type** must be **Auto**
    - **Control Mode** must be set to **Auto**
  - When DIO 5 is shorted, the Remote Set Point/Analog Input 2, will be the Active Set Point
  - When DIO 5 is opened, the Closed Loop Set Point, will be the Active Set Point.
4. Set the Function Key with the function of switching to the remote set point by going to **Operations — Setup — Function Key — Action Function**.
  - For this to function properly, ensure the following is set in **Operations — Setup — Control Loop**
    - **Remote Set Point** must be **No**
    - **Remote Set Point Type** must be **Auto**
    - **Control Mode** must be set to **Auto**
  - When the Function Key is pressed, the Remote Set Point/Analog Input 2 will be the Active Set Point.
  - When the Function Key is pressed, the Closed Loop Set Point will be the Active Set Point.

## Ten Point Linearization

The linearization function allows a user to re-linearize a value read from an analog input. There are 10 data points used to compensate for differences between the sensor value read (input point) and the desired value (output point). Multiple data points enable compensation for non-linear differences between the sensor readings and target process values over the thermal or process system operating range. Sensor reading differences can be caused by sensor placement, tolerances, an inaccurate sensor or lead resistance.

The user specifies the unit of measurement and then each data point by entering an input point value and a corresponding output point value. Each data point must be incrementally higher than the previous point. The linearization function will interpolate data points linearly in between specified data points.

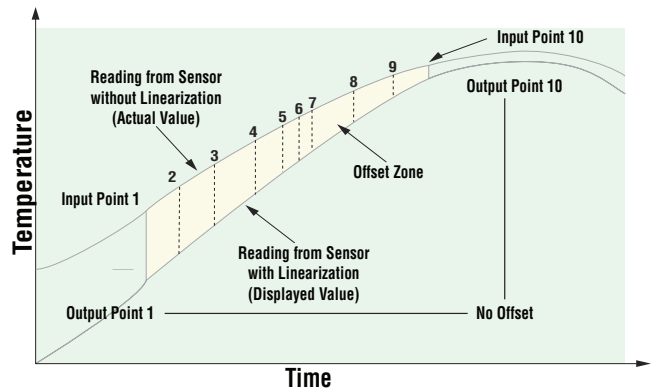

Output Point 1 is the minimum value that can be displayed, and Output Point 10 is the maximum value that can be displayed. Consider setting Output Point 1 to the minimum operating range and Output Point 10 to the maximum operating range for that sensor type.

## Output Features

### Duplex

Certain systems require that a single process output, control both heating and cooling outputs. A PM PLUS™ with a process output can function as two separate outputs. With a 4 to 20mA output the heating output will operate from 12 to 20mA (0 to +100 percent) and the cooling output will operate from 12 to 4mA (0 to -100 percent).

In some cases this type of output is required by the device the PM PLUS™ controls, such as a three-way valve that opens one way with a 12 to 20mA signal and opens the other way with a 4 to 12mA signal. This feature reduces the overall system cost using a single output to act as two outputs.

Outputs 1 and 3 can be ordered as process outputs. Select duplex as the Output Function (Setup Page, Output Menu). Set the output to volts or milliamps with Type. Set the range of the process output with Scale Low and Scale High.

### NO-ARC Relay

A NO-ARC relay provides a significant improvement in the life of the output relay over conventional relays. Conventional mechanical relays have an expected life of 100,000 cycles at the rated full-load current. The shorter life for conventional relays is due to the fact that when contacts open while current is flowing metal degradation occurs. This action produces unavoidable electrical arcing causing metal to transfer from one contact to the other. The arcing conditions continue on each subsequent contact opening until over time the resistance through the contacts increases causing the contacts to increase in temperature. Eventually, the contacts will weld together and the relay remains in the on state.

The Watlow NO-ARC relay is a hybrid that uses a mechanical relay for the current load and a triac (solid-state switch) to carry the turn-on and turn-off currents. NO-ARC relays extend the life of the relay more than

two million cycles at the rated full-load current.

Although a NO-ARC relay has significant life advantages, a few precautions must be followed:

**Do not use:**

- Hybrid relays for limit contactors. A limit or safety device must provide a positive mechanical break on all hot legs simultaneously
- DC loads with hybrid relays. The triacs used for arc suppression will turn off only with ac line voltage
- Hybrid switches to drive any inductive loads, such as relay coils, transformers or solenoids
- Cycle times less than five seconds on hybrid switches
- On loads that exceed 264V ac through relay
- On loads that exceed 15 amperes load
- On loads less than 100mA
- NO-ARC relays in series with other NO-ARC relays

## Retransmitting a Process Value or Set Point

Applicable on models with a Universal Process output 1 and 3. Check your product label to confirm the configuration code shows F in the 6th or 10th digit: PM \_\_\_ [F] \_ - \_\_ [F] \_ \_ \_ .

The retransmit feature allows a process output to provide an analog signal that represents the set point or process value. The signal may serve as a remote set point for another controller or as an input for a chart recorder documenting system performance over time.

Outputs 1 and 3 can be ordered as process outputs. To configure these outputs, go to **Operations — Setup — Output — Output [1,3] — Function —** and select **Retransmit**. Set the output to **volts** or **milliamps** with **Type**. Select the signal to retransmit with **Retransmit Source**. Set the range of the process output with **Scale Low** and **Scale High**. Scale the retransmit source to the process output with **Range Low** and **Range High**.

In choosing the type of retransmit signal, consider the input impedance of the device to be retransmitted to and the required signal type, either voltage or milliamps. Typically applications might use the retransmit option to record one of the variables with a chart recorder or to generate a set point for other controls in a multi-zone application.

When the retransmit source is at the Range Low value, the retransmit output will be at its Scale Low value. When the retransmit source is at the Range High value, the retransmit output will be at its Scale High value.

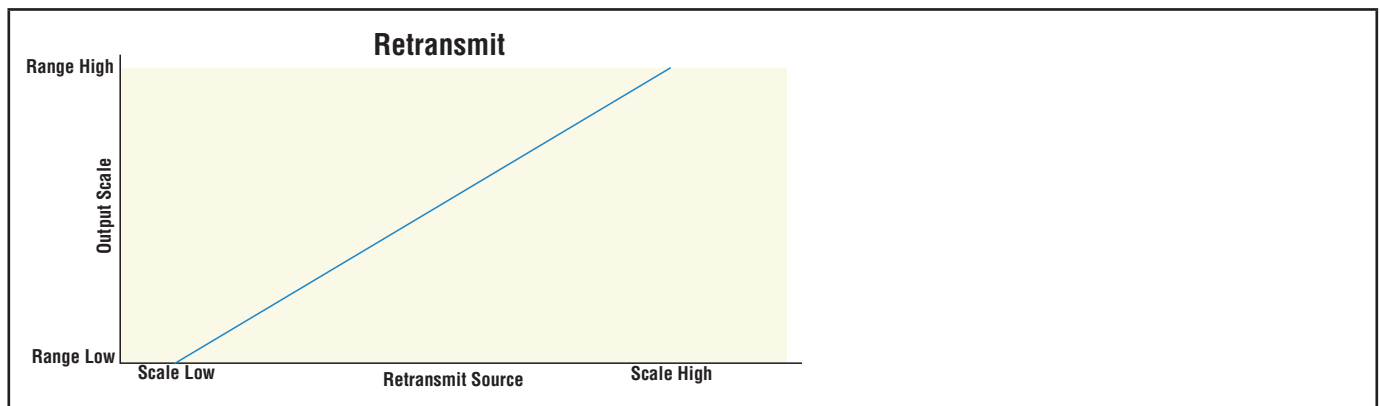

## Cool Output Curve

A nonlinear output curve may improve performance when the response of the output device is nonlinear. If a cool output uses one of the nonlinear curves a PID calculation yields a lower actual output level than a linear output would provide. These output curves are used in plastics extruder applications: curve A for oil-cooled extruders and curve B for water-cooled extruders.

To configure a cool output curve, go to **Operations — Setup — Control Loop** and select **Cool Output Curve**.

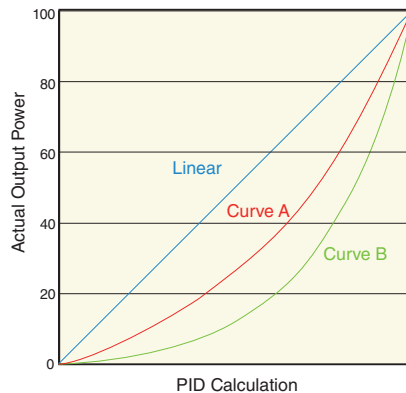

## Resetting a Tripped Limit

*Applicable on Integrated Limit models. Check your product label to confirm the configuration code shows L or M in the 9th digit: PM \_\_\_\_\_ - \_ [L,M] \_\_\_\_\_.*

On Limit models, output 4 is a Form A (normally open) Mechanical Relay and it is internally tied to the limit function. When the limit is in a safe state the internal coil for this relay is energized, and the relay will be closed. When a condition causes the limit to trip, the internal coil de-energizes, causing the relay to latch open. When the condition that caused the limit to trip is within the limit range, plus the hysteresis value; the relay remains latched open until manually reset by an operator.

### Reset a Tripped Limit (Use one of these four methods)

1. When at the Home Page, and a Limit condition occurs; then "Attention Limit" will appear. It will also state "Press Home to Request Clear".
2. Set Source Function A to the device that will reset the limit (Digital I/O or Function Key).
3. Use a field bus protocol, i.e., Modbus<sup>®</sup>, EtherNet/IP<sup>™</sup>, etc. and write a value of zero to the associated address (navigate to the Operations List — and look for Clear Limit under the Limit Menu to find appropriate address).
4. Cycle the power to the controller.

---

# Control Methods

## Output Configuration

Each controller output can be configured as a heat output, a cool output, an alarm output or deactivated. No dependency limitations have been placed on the available combinations. The outputs can be configured in any combination. For instance, all three could be set to cool.

Heat and cool outputs use the set point and Operations parameters to determine the output value. All heat and cool outputs use the same set point value. Heat and cool each have their own set of control parameters. All heat outputs use the same set of heat control parameters and all cool outputs use the same set of cool output parameters.

Each alarm output has its own set of configuration parameters and set points, allowing independent operation.

## Auto (closed loop) and Manual (open loop) Control

The controller has three modes of operation: auto, manual, and off.

Auto mode allows the controller to decide whether to perform closed-loop control or to follow the settings of Input Error Failure. The manual mode only allows open-loop control. The PM PLUS™ is normally used in the auto mode. The manual mode is usually only used for specialty applications or for troubleshooting.

Manual mode is open-loop control that allows the user to directly set the power level to the controller's output load. No adjustments of the output power level occur based on temperature or set point in this mode.

Off deactivates the control loop and all outputs attached to the control loop are turned off.

In auto mode, the controller monitors the input to determine if closed-loop control is possible. The controller checks to make certain a functioning sensor is providing a valid input signal. If a valid input signal is present, the controller will perform closed-loop control. Closed-loop control uses a process sensor to determine the difference between the process value and the set point. Then the controller applies power to a control output load to reduce that difference. If a valid input signal is not present, the controller will indicate an input error message on the Home Screen and respond to the failure according to the setting of Input Error Failure. You can configure the controller to perform a bumpless transfer, switch power to output a preset fixed level, or turn the output power off.

### Selecting Auto or Manual Control Mode:

1. Go to **Operations — Setup — Control Loop —**
2. Scroll to and select **Control Mode**
3. Select the desired mode: **Auto or Manual or Off**

This change takes effect immediately.

## Bumpless Transfer

Bumpless transfer allows the controller to transfer to manual mode using the last power value calculated in auto mode if the process had stabilized at a  $\pm 5$  percent output power level for the time interval or 10 seconds, (whichever is longer) prior to sensor failure, and that power level is less than 75 percent. Reverse Bumpless functionality will take effect when the control is changed from Manual to Auto mode. The control will preload the Manual Power value into the Integral and Proportional Terms, which will allow for a bumpless transition. The normal PID action will then take over to control the output to the Set Point value.

Reverse bumpless does not occur for the transition from Off to Auto.

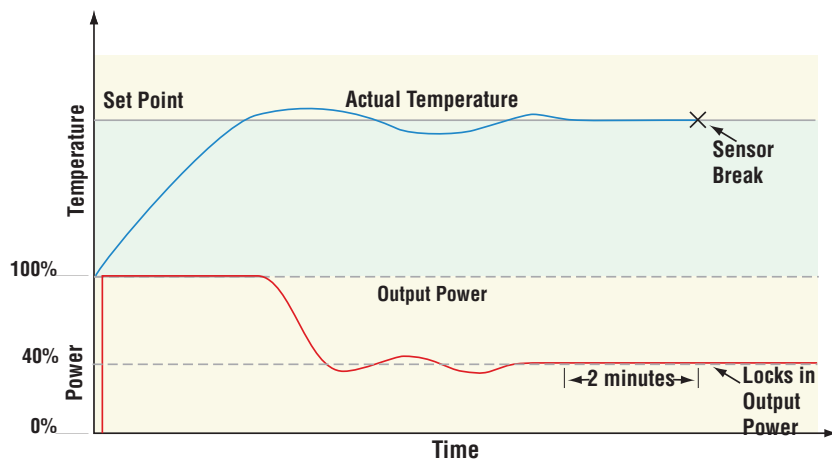

Input Error Latching (**Operations — Setup — Analog Input — [on,off]**) determines the controller's response once a valid input signal returns to the controller.

- If latching is **on**, the controller will indicate an input error until the error is cleared. To clear a latched alarm, press the Home icon as indicated on the screen.
- If latching is **off**, the controller will automatically clear the input error and return to reading the temperature. If the controller was in the auto mode when the input error occurred, it will resume closed-loop control.
- If the controller was in manual mode when the error occurred, the controller will remain in open-loop control. The Manual Control Indicator Light % is on when the controller is operating in manual mode.

## On-Off Control

On-off control switches the output either full on or full off, depending on the input, set point and hysteresis values.

The hysteresis value indicates the amount the process value must deviate from the set point to turn on the output. Increasing the value decreases the number of times the output will cycle. Decreasing hysteresis improves controllability. With hysteresis set to 0, the process value would stay closer to the set point, but the output would switch on and off more frequently, and may result in the output "chattering."

On-off control can be selected with Heat Algorithm (**Operations — Setup - Control Loop - Heat Algorithm**) or Cool Algorithm (**Operations — Setup - Control Loop - Cool Algorithm**). Then, On/Off hysteresis can be set at **Operations — Setup - Control Loop - On/Off Heat Hyster.** or **Operations — Setup - Control Loop - On/Off Cool Hyster..**

Input Error failure mode does not function in on-off control mode. The output goes off.



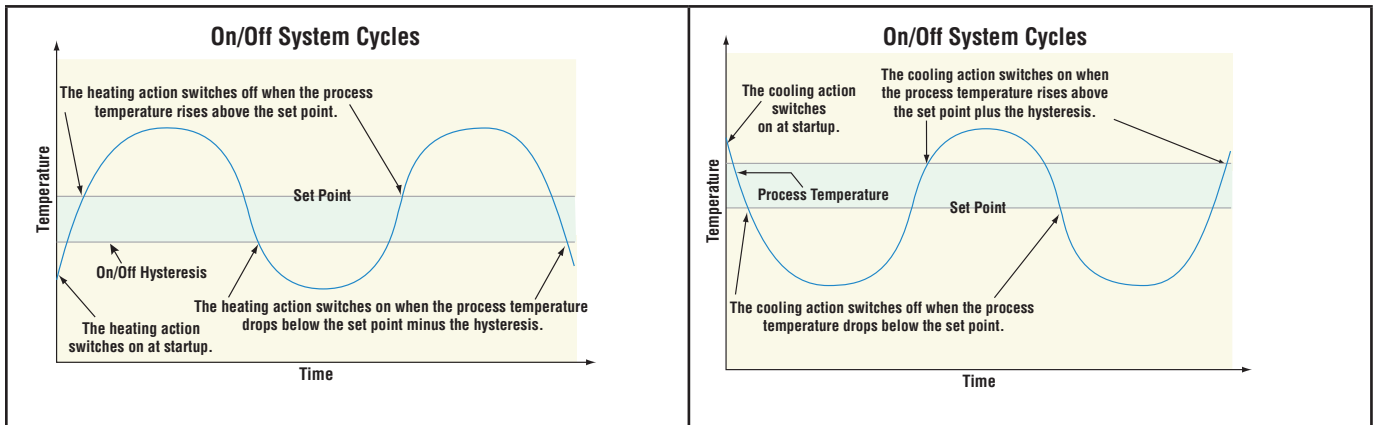

## Proportional and (P) Control

Some processes need to maintain a temperature or process value closer to the set point than on-off control can provide. Proportional control provides closer control by adjusting the output when the temperature or process value is within a proportional band. When the value is in the band, the controller adjusts the output based on how close the process value is to the set point. The closer the process value is to the set point, the lower the output power. This is similar to backing off on the gas pedal of a car as you approach a stop sign. It keeps the temperature or process value from swinging as widely as it would with simple on-off control. However, when the system settles down, the temperature or process value tends to "droop" short of the set point.

With proportional control, the output power level equals the set point minus the process value divided by proportional band times 100. In an application with one output assigned to heating and another assigned to cooling, each will have a separate proportional parameter. The heating parameter takes effect when the process temperature is lower than the set point, and the cooling parameter takes effect when the process temperature is higher than the set point.

Adjust the proportional band with Heat Proportional Band or Cool Proportional Band (**Operations — Setup - Control Loop**).

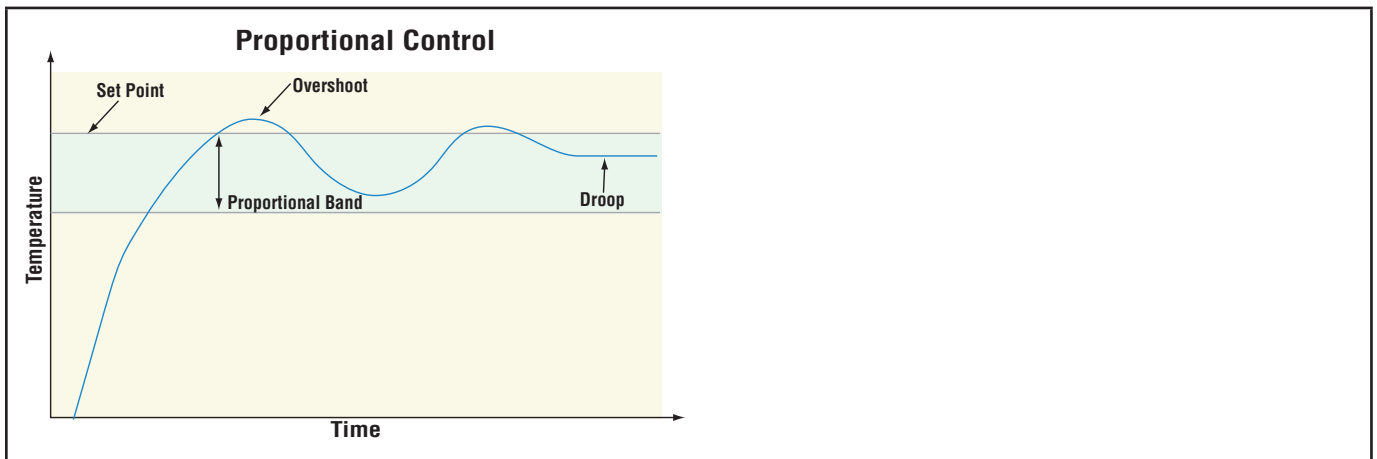

## Proportional and Integral (PI) Control

The droop caused by proportional control can be corrected by adding integral (reset) control. When the system settles down, the integral value is tuned to bring the temperature or process value closer to the set point. Integral determines the speed of the correction, but this may increase the overshoot at startup or when the set point is changed. Too much integral action will make the system unstable. Adjust the integral with Time Integral (**Operations — Setup - Control Loop**).

# Proportional, Integral and Derivative (PID) Control

Use derivative (rate) control to minimize the overshoot in a PI-controlled system. Derivative (rate) adjusts the output based on the rate of change in the temperature or process value. Too much derivative (rate) will make the system sluggish. Adjust the derivative with Time Derivative (Operations Page, Loop Menu).

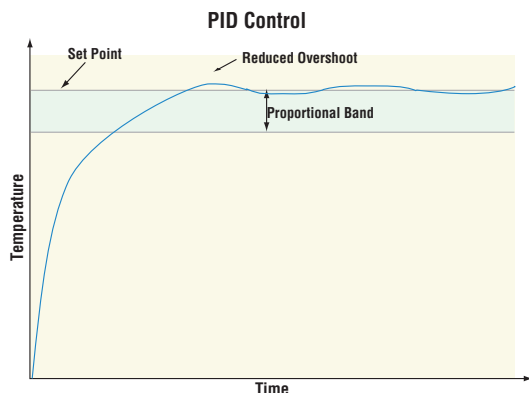

## Dead Band

In a PID application the dead bands above and below the set point can save an application's energy and wear by maintaining process temperature within acceptable ranges.

Proportional action ceases when the process value is within the dead band. Integral action continues to bring the process temperature to the set point. Using a **positive dead band value** keeps the heating and cooling from fighting each other.

When the dead band value is zero, the heating output activates when the temperature drops below the set point, and the cooling output switches on when the temperature exceeds the set point.

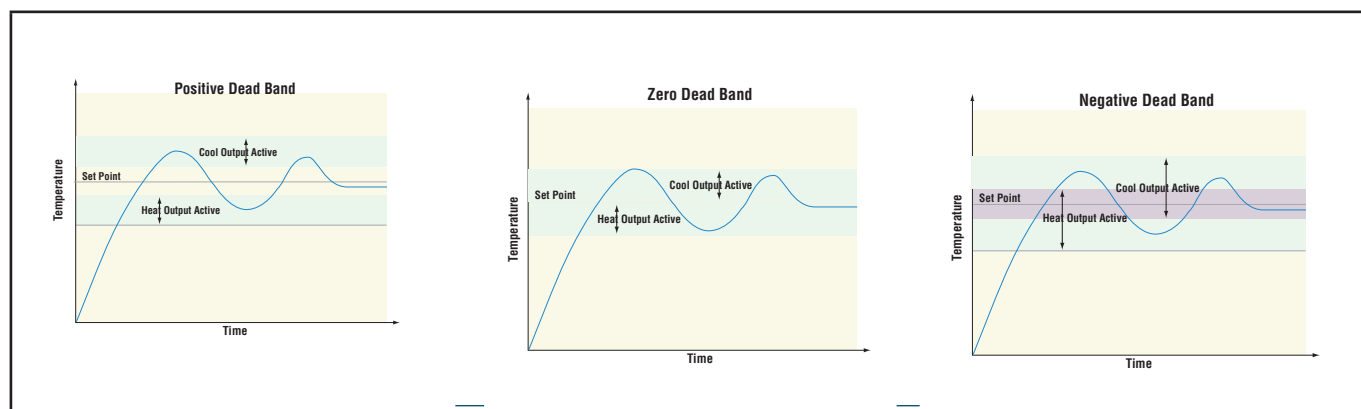

When the dead band value is a negative value, both heating and cooling outputs are active when the temperature is near the set point.

Go to **Operations — Setup — Control Loop — Deadband** to adjust.

## Variable Time Base

Variable time base is the preferred method for controlling a resistive load, providing a very short time base for longer heater life. Unlike phase-angle firing, variable-time-base switching does not limit the current and voltage applied to the heater. With variable time base outputs, the PID algorithm calculates an output between 0 and 100%, but the output is distributed in groupings of three ac line cycles. For each group of three ac line cycles, the controller decides whether the power should be on or off. There is no fixed cycle time since the decision is made for each group of cycles. When used in conjunction with a zero cross (burst fire) device, such as a solid-state power controller, switching is done only at the zero cross of the ac line, which helps reduce electrical noise (RFI). Variable time base should be used with solid-state power controllers, such as a solid-state relay (SSR) or silicon controlled rectifier (SCR) power controller. Do not use a variable time base output for controlling electromechanical relays, mercury displacement relays, inductive loads or heaters with unusual resistance characteristics.

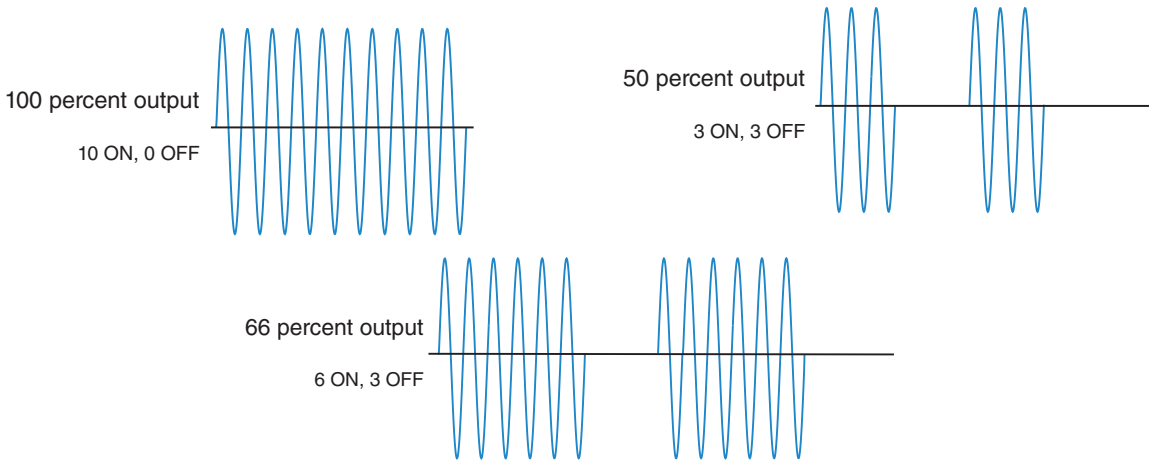

The combination of variable time base output and a solid-state relay can inexpensively approach the effect of analog, phase-angle fired control. Select the AC Line Frequency at **Operations — Setup - Global - AC Line Frequency**), 50 or 60 Hz.

## Single Set Point Ramping

Ramping protects materials and systems that cannot tolerate rapid temperature changes. The value of the ramp rate is the maximum degrees per minute or hour that the system temperature can change.

Note - Single Set Point Ramping should be set to Off, when running a Profile.

Select Ramp Action (**Operations — Setup - Control Loop - Ramp Action**):

- **Off** ramping not active.
- **Start** ramp at startup.
- **Set Point** ramp at a set point change.
- **both** ramp at startup or when the set point changes.

Once the Ramp Action is selected, you can go back to the Control Loop List and select whether the rate is in degrees per minute or degrees per hour at **Operations — Setup - Control Loop - Ramp Scale** and then set the ramping rate at **Operations — Setup - Control Loop - Ramp Rate**

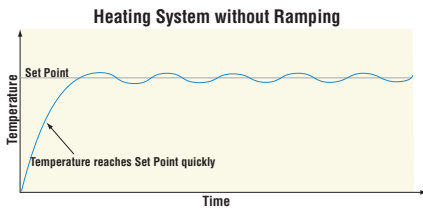

## Compressor Control

The PM PLUS can be configured for Compressor control with two loops of control and enhanced firmware, as frequently used for cooling and/or dehumidification. The application may have one or two loops of control that utilize the compressor for cooling and/or dehumidification (negative power levels). Because the compressor is a mechanical device, it is desirable to minimize unwanted starts and stops. Either loop can attempt to start or stop the compressor, but this algorithm will determine when it should or should not run. Because you may not turn the compressor off until the loop is in the heat or humidify region, the input values (Source Function A and B) to the compressor algorithm must be loop power (+/- 100%).

The compressor turns on and off under the following conditions:

Loop 1	Loop 2
Off - When Source A Value $\geq$ Input A Turn Off	Off - When Source B Value $\geq$ Input B Turn Off
On - When Source A Value $\leq$ Input A Turn On	On - When Source B Value $\leq$ Input B Turn On

To prevent unwanted on/off cycling and compressor wear, set the Minimum On Time and Minimum Off Time for the compressor.

The Time Delay setting is used to avoid having the compressor remain on indefinitely if the loop control modes are set to off, such as when a profile ends. The rule for the Time Delay setting follows:

Off - Source A Value and Source B Value = 0.0% for a period longer than Time Delay

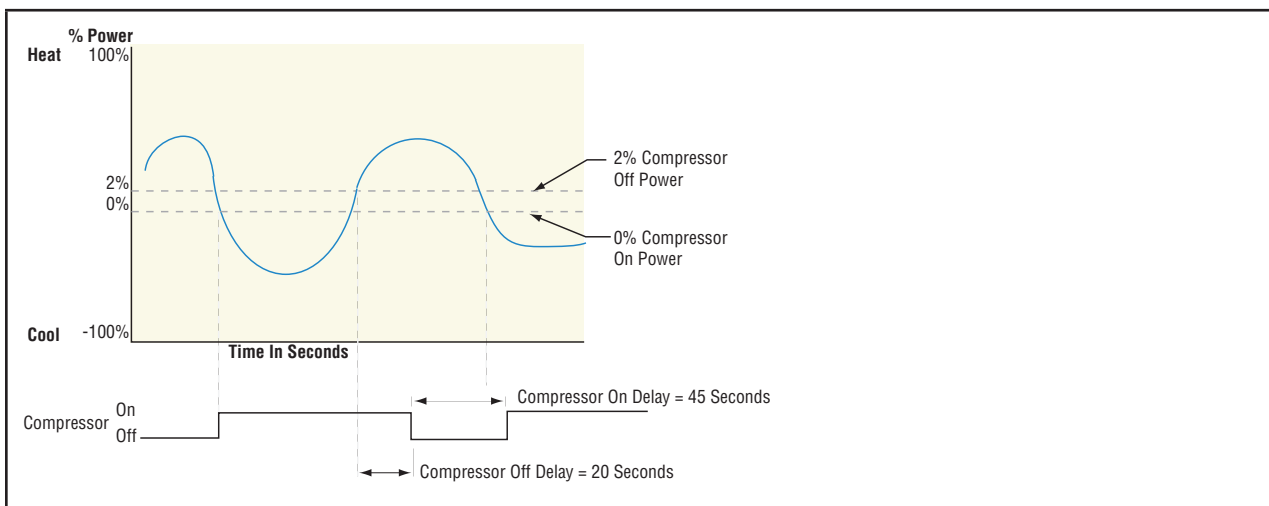

# Differential Control

The PM can be configured for Differential Control with two inputs and enhanced firmware. After configuring the appropriate inputs and their associated internal functions Differential Control allows the PM to drive an output based on the difference between those analog inputs. See [Application examples](#).

# Ratio Control

The PM PLUS can be configured for Ratio control with two inputs and enhanced firmware, especially useful in applications that mix materials. Ratio control is commonly used to ensure that two or more flows are kept at the same ratio even if the flows are changing. See [Application examples](#).

# Duplex Control

Certain systems require that a single process output controls both heating and cooling outputs. A PM PLUS with a process output can function as two separate outputs.

With a 4 to 20mA output the heating output, for instance, will operate from 12 to 20mA (0 to +100%) and the cooling outputs will operate from 12 to 4mA (0 to -100%). In some cases this type of output is required by the device, such as a three-way valve that opens one way with a 12 to 20mA signal and opens the other way with a 4 to 12mA signal. This feature reduces the overall system cost using a single output to act as two outputs.

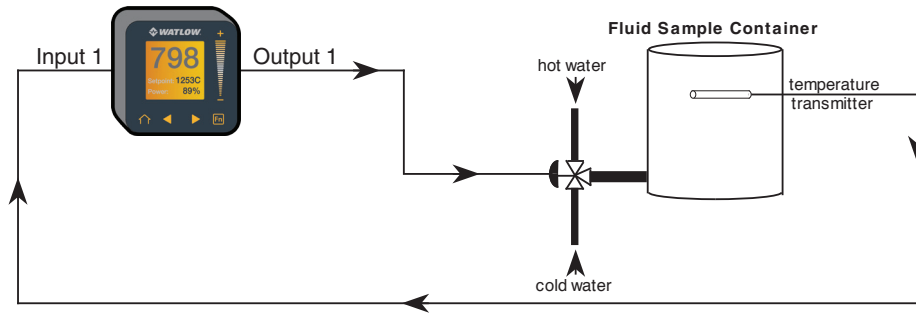

# Motorized Valve Control

A motorized valve is used to regulate the flow of fluid which in turn impacts the loop process value. A valve is opened or closed by closing contacts to drive the valve in the intended direction.

---

# Timer Function

Applicable on models with a countdown timer. Check your product label to confirm the configuration code shows T in the 4th digit: PM \_ T \_ \_ \_ - \_ \_ \_ \_ \_ .

The timer feature is only available for control loop 1 of two-loop controllers. Time is entered in hours, minutes and seconds. Countdown time will use the entered time but display the time remaining in either hh:mm or mm:ss format, based on your settings. The colon pulses in one-second intervals during a countdown, to indicate that timing is underway. Parameters that appear on the Home Screen have the number 1 at the end of the displayed parameter. As an example, **hour** in Operations — Setup - Timer will be displayed as **hour1** on the Home Screen.

When Timer Enable is set to yes and the timer is started, the controller switches from Set Point to Closed Loop Timer Set Point. You have four options for the start method: immediate, ready band, ready acknowledge, and power. Refer to "[Setting Up the Timer Function](#)" for details.

If the timer is interrupted, the timer is terminated and the time remaining is reset to its initial value.

Go to **Operations — Setup — Output — [Output 1, Output 2] — Function —** to assign an output function to **Timer Event Output 1**, **Timer Event Output 2** or **Timer Event Output 3**. Timer Event Output 1 is active during timing, Timer Event Output 2 is deactivated during timing and Timer Event Output 3 produces a pulse at the end of the timing sequence. These signals may be used to monitor timer activity. Process outputs may not be assigned to Timer Event Outputs.

## Setting up the Timer Function

1. Go to **Operations — Setup — Timer**.
2. Press the right arrow key to select **Timer Enable** , then select **Yes**.
3. Left back arrow to return to the **Setup — Timer** list.
4. Scroll to and select **Timer Start Method** then select the desired option:
  - **Immediate**, the timer starts as soon as the counter is initiated. When Time Remaining equals zero, the set point changes from Closed Loop Timer Set Point back to Set Point. A flashing colon **00:00** indicates that a countdown is in progress.
  - **Ready Band**, the set point changes and when the temperature is within ready band, the ready band icon lights up and the countdown timer starts and continues as long as the temperature is within the ready band. When Time Remaining equals zero, the set point changes from Closed Loop Timer Set Point back to Set Point. A flashing colon **00:00** indicates that a countdown is in progress.
  - **Ready Acknowledge**, the set point changes, and when the temperature is within the ready band, the ready band icon lights up. The user must then acknowledge (you define which key combination for this) that the countdown timer should start and continue as long as the temperature is within the ready band. When Time Remaining equals zero, the set point changes from Closed Loop Timer Set Point back to Set Point. A flashing colon 00:00 indicates that a countdown is in progress.
  - **Power**, the timer starts when the controller is turned on. When Time Remaining equals zero, the set point changes from Closed Loop Timer Set Point back to Set Point. A flashing colon **00:00** indicates that a countdown is in progress.
5. Scroll to select the input "Source Function A" that will start/terminate the timer:
  - **None**
  - **Digital I/O**
  - **Function Key**
6. Use the numeric slider or +/- key to set the instance for that function:
  - If None: you can leave this default (It does not matter what number is entered here).
  - If Digital I/O: Enter the DIO [5 or 6] associated with this timer
  - If Function Key: enter source instance 1

1. Left back arrow to the Timer List, then scroll to and select **Source Function C**.
2. Select the function:
  - **None**
  - **Analog Input**
  - **Linearization**
  - **Process Value**
3. Use the numeric slider or +/- key to set the instance of that function, either 1 or 2.
4. Left back arrow to return to the Timer menu, then scroll to and select **Source Function D**.
5. Select the function:
  - **None**
  - **Digital I/O**
  - **Function Key**
6. Use the numeric slider or +/- key to set the instance of that function.
  - If None: you can leave this default (It does not matter what number is entered here).
  - If Digital I/O: Enter the DIO [5 or 6] associated with this timer
  - If Function Key: enter source instance 1
7. Left back arrow to return to the Timer list, then scroll to and select Time Remaining.

---

## Alarms

Alarms are activated when the output level, process value or temperature leaves a defined range. A user can configure how and when an alarm is triggered, what action it takes and whether it turns off automatically when the alarm condition is over. Configure alarm outputs in the Setup Page before setting alarm set points. Alarms do not have to be assigned to an output. Alarms can be monitored and controlled through the front panel or using software.

### Process and Deviation Alarms

A process alarm uses one or two absolute set points to define an alarm condition. A deviation alarm uses one or two set points that are defined relative to the set point used by the control loop. Deviation high and low alarm set points are calculated by adding or subtracting offset values from the set point used by the control loop. If the set point changes, the window defined by the deviation alarm set points automatically moves with it. Select the type with Type (Setup Page, Alarm Menu).

### Set Points

The high set point defines the process value or temperature that will trigger a high side alarm. The low set point defines the temperature that will trigger a low side alarm. For deviation alarms, a negative set point represents a value below set point used by the control loop. A positive set point represents a value above the set point used by the control loop. View or change alarm set points with Low Set Point and High Set Point (Operations Page, Alarm Menu).

# Hysteresis

An alarm state is triggered when the process value reaches the high or low set point. Hysteresis defines how far the process must return into the normal operating range before the alarm can be cleared.

Hysteresis is a zone inside each alarm set point defined by adding the hysteresis value to the low set point or subtracting the hysteresis value from the high set point.

To view or change hysteresis **Operations — Setup — Alarm — Alarm [1,2,3,4] — Hysteresis** — and enter the value to be added to the low set point, or subtracted from the high set point.

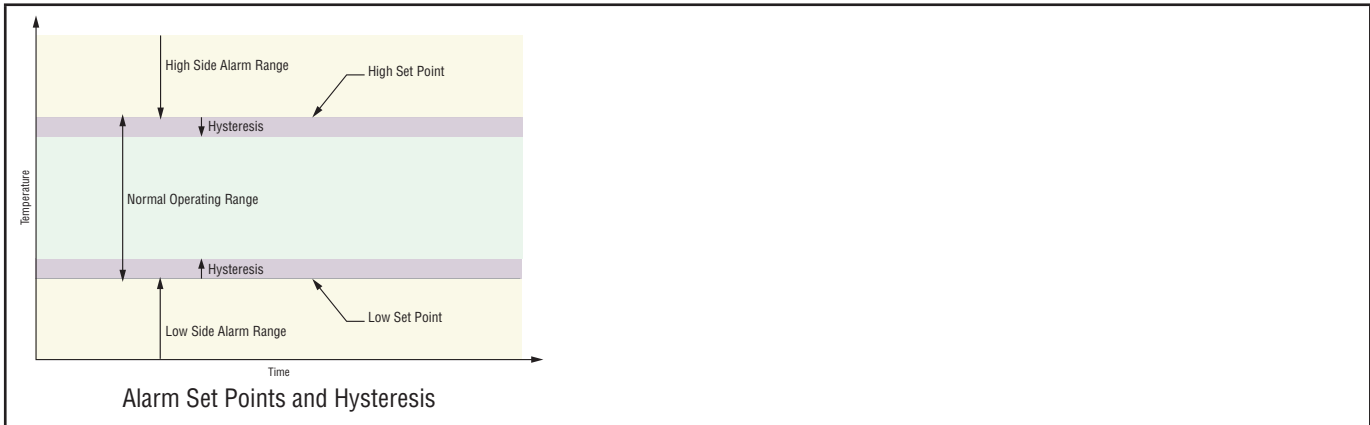

# Latching

A latched alarm will remain active after the alarm condition has passed. An active message, such as an alarm message, will cause the normal Home Screen display to toggle with the active message. Press the Home key to silence the active message.

An alarm that is not latched (self-clearing) will deactivate automatically when the alarm condition has passed.

## Turn latching on or off with Latching

1. Go to **Setup Page, Alarm - Alarm [1234]**
2. Select Non-Latching or Latching.
3. Press the Home icon to exit configuration.

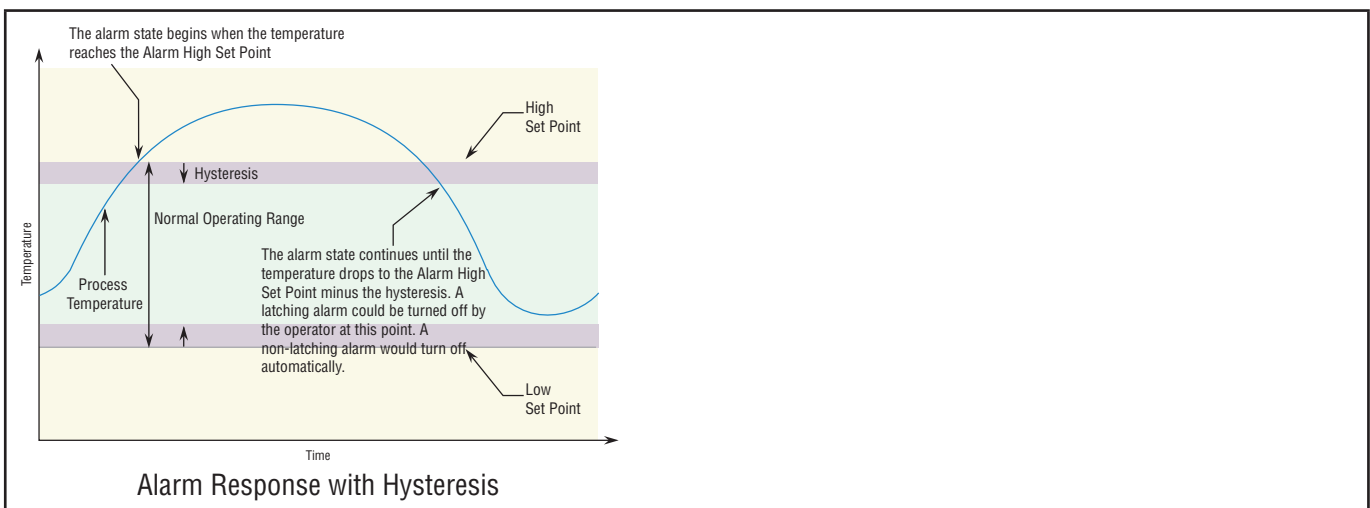



## Silencing Alarms

If silencing is on you can disable the alarm output while the controller is in an alarm state. The process value or temperature has to enter the normal operating range beyond the hysteresis zone to activate the alarm output function again. An active message, such as an alarm message, will cause the display to toggle between the normal settings and the active message on the Home screen display.

To enable alarm silencing, go to **Operations — Setup — Alarm — Alarm [1,2,3,4] — Silencing — [Off,On]**,

NOTE: If silence is on, and you silence with Home Key, the message is cleared, but the warning symbol remains.

## Blocking Alarms

Blocking allows a system to warm up after it has been started up. With blocking on, an alarm is not triggered when the process temperature is initially lower than the low set point or higher than the high set point. The process temperature has to enter the normal operating range beyond the hysteresis zone to activate the alarm function. If the PM PLUS has an output that is functioning as a deviation alarm, the alarm is blocked when the set point is changed, until the process value re-enters the normal operating range.

To enable alarm silencing, go to **Operations — Setup — Alarm — Alarm [1,2,3,4] — Blocking —** and then select the desired blocking option: **[Off,Startup,Set Point,Both]**,

---

## Current Sensing

The measurements taken for current sensing use the AC Line Frequency setting found at **Operations — Global — AC Line Frequency — [50Hz,60Hz]**. If this setting does not represent the incoming line frequency of this controller the readings will be in error and may appear to be frozen.

If an alarm is configured to monitor current, the low alarm is effective only when the current level is equal to or greater than 2mA. If there is no current present, the low alarm will not be activated.

## Open and Shorted Load Circuit Detection

A Current Error C.Er (Operations Page, Current Menu) can detect either an open or shorted load condition. A shorted condition would be present if the control is calling for 0% power while current is detected as flowing through the current transformer. Conversely, an open condition would be present when the control is calling for power with no current flow detected through the transformer.

A Heater Error indicates if the load current flow is outside the specified limits set by the user through the Current Set Points (High Set Point and Low Set Point) at **Operations — Current**.

Read and monitor the real-time current level through the Load Current RMS prompt while the most recent faults can be read via the Current Error and Heater Error prompts. All of these prompts can be found in the Operations Page under the Current Menu.

CT Application NOTE: Alarms have to point to the correct source for the current measurement. We have one measurement that is sampled and held CU.r. Since this is a zero cross device, in zero cross the current is going to 0 each time the output is turned off. We also calculate an Current RMS value that takes into account on time versus off time. Be sure alarms are pointed to the current that is sampled and held or anytime the PID power gets low like less than 2%, the alarm will activate or if the outputs are off such as control mode set to OFF.

## Open Loop Detection

When Open Loop Detection is enabled, the controller will look for the power output to be at 100%. Once there, the control will then begin to monitor the Open Loop Detect Deviation as it relates to the value entered for the Open Loop Detect Time. If the specified time period expires and the deviation does not occur, an Open Loop Error will be triggered. Once the Open Loop Error condition exists the control mode will go off and an Open Loop message will be display. If the process value goes in the opposite direction, a Reversed Loop message is displayed. The sensor is likely wired in reverse polarity.

All prompts identified in this section can be found in the Loop Menu of the Setup Page.

## Programming the Function Key

- Go to **Operations — Setup — Function Key — Active Level — [High,Low]** and use the right arrow key to select the desired level:
  - Select **High** and the function will NOT be enabled on power up.
  - Select **Low** and the function WILL be enabled on power up.
- Go to **Operations — Setup — Function Key — Action Function — [available functions]** and use the right arrow key to select the desired function.
- Function Instance - which instance of the function chosen.

## Security Features

You may restrict user access to specified Lists and parameters by selecting desired Lock Levels. You may add an additional layer of security by enabling Passwords.

### Read Lock and Set Lock Levels

There are two types of Lock Levels: Set Locks and Read Locks. You can specify Read Lock Levels to restrict visibility into Lists, and Set Lock Levels to restrict read/write access to users who need not set parameters in every List. Each Lock Level provides access to specific Lists as detailed below.

<b>SECURITY LOCK LEVELS</b>					
<b>Set Lock Levels (Read/Write)</b>	Set Lock 0	Set Lock 1	Set Lock 2	Set Lock 3	Set Lock 4 or 5
Factory List	R/W	R/W	R/W	R/W	R/W
Home Screen	R	R/W	R/W	R/W	R/W

<b>SECURITY LOCK LEVELS</b>					
Operations List	R	R	R/W	R/W	R/W
Profile List	R	R	R	R/W	R/W
Setup List	R	R	R	R	R/W
<b>Read Lock Levels (Visibility)</b>		Read Lock 1	Read Lock 2	Read Lock 3	Read Lock 4 or 5
Factory List		visible	visible	visible	visible
Home Screen		visible	visible	visible	visible
Operations List		hidden	visible	visible	visible
Profile List		hidden	hidden	visible	visible
Setup List		hidden	hidden	hidden	visible

\*You may notice that the Factory List is R/W in every Set Lock Level, but that is so that you can specify Lock Levels upon individual items in the Factory List separately.

<b>SECURITY LOCK LEVELS for FACTORY LIST</b>					
<b>Set Lock Levels (Read/Write)</b>	Set Lock 0	Set Lock 1	Set Lock 2	Set Lock 3	Set Lock 4 or 5
Factory — Custom Setup	R	R	R	R	R/W
Factory - Lock	R/W	R/W	R/W	R/W	R/W
Factory - Diagnostics	R	R	R	R	R
Factory - Calibration	R	R	R	R	R/W
<b>Read Lock Levels (Visibility)</b>		Read Lock 1	Read Lock 2	Read Lock 3	Read Lock 4 or 5
Factory — Custom Setup		hidden	hidden	hidden	visible
Factory - Lock		visible	visible	visible	visible
Factory - Diagnostics		visible	visible	visible	visible
Factory - Calibration		hidden	hidden	hidden	visible

### Changing List Set Lock and Read Lock Levels

1. Go to **Operations — Factory — Lock —**
2. Scroll to and select **Read Lock**.
3. Use the numeric slider or +/- keys to enter the desired Read Lock security level. This Lock type determines which lists are visible to users at all:
  - 1 = Users can view the Home Screen and Factory List.
  - 2 = Users can view the Home Screen, Factory List, and Operations List.
  - 3 = Users can view the Home Screen, Factory List, Operations List, and Profile List
  - 4 or 5 = Users can view the Home Screen and all Lists.
4. Press the left back arrow to return to the Lock List, then select Write Security.
5. Use the numeric slider or +/- keys to enter the desired Write Security level: Set Lock Levels: This Lock type determines the Lists in which users can set (change) parameters:
  - 0 = Users can set parameters in the Factory page only\*
  - 1 = Users can set parameters on the Home Screen and Factory List.

- 2 = Users can set parameters on the Home Screen, Factory List, and Operations List.
- 3 = Users can set parameters on the Home Screen, Factory List, Operations List, and Profile List
- 4 or 5 = Users can set all parameters on the device, in the Home Screen, Factory List, Operations List, Profile List, and Setup List.

1. Press the Home icon to exit

NOTE: If you use Set or Read Lock Levels to secure lists on the device, all settings can be modified by anyone who can find their way to the Set Lock Level or Read Lock Level parameters.

## Passwords

Enabling passwords provides an additional layer of security. With passwords enabled, you select a Lock Level defining what users can view or set prior to entering a password. Then when the user enters the password, the user has the permissions as were set in the Read Lock and Set Lock security Levels.

### Enabling Passwords

Before you enable passwords, note that it is vital you save the password for future use in accessing restricted Lists. You must determine a safe place to store your passwords outside of the device.

1. Go to **Operations — Factory — Lock**
2. Scroll to and select **Password Enable**, then select **On**.
3. Press the Left Arrow to go back to the Lock list, then scroll to select **Locked Access Level**.
4. Use the slider to select the **Locked Access Level [1-5]**, which defines what users have access to prior to entering a password. Refer to the Security Lock Levels table.
5. (This step is optional, and not recommended in most scenarios) Press the Left Arrow to go back to **Factory - Lock**, then scroll to Rolling Password and select Off or On. This configures the device to change a Public Key Code every time power is cycled. This public key code is then used in a formula along with the user or admin password to discern the real time password for the device.

Rolling Password Formula for user passwords:  $(\text{Password} \times \text{Public Key}) \text{ Mod } 929 + 70$

Rolling Password Formula for admin passwords:  $(\text{Password} \times \text{Public Key}) \text{ Mod } 997 + 1000$ .

6. Press the Left Arrow to go back to the Lock list, then scroll to select **User Password**.
7. Use the numeric slider to set the password. The default is 63, which you can keep or change. Be sure to make note of this number and save it somewhere outside the device for future use.

This takes effect after a power cycle.

Once in effect, users must enter this password to gain access to the device beyond the Locked Access Level set in step 4. After the password is entered, they will be subjected to the Read and Set Lock Levels configured separately in **Read Lock** and **Write Security** (Refer to "[Changing List Set Lock and Read Lock Levels](#)").

8. Press the Left Arrow to go back to the Lock list, then scroll to select **Administrator Password**. This is the password you will need if you wish to change any future user passwords.
9. Use the numeric slider or +/- keys to set the password. The default is 156, which you can keep or change.

1. Be sure to make note of this number and save it somewhere outside the device for future use.

### Accessing the Device with Passwords Enabled

1. Go to **Operations — Factory** and select **Unlock**.
2. Use the slider to enter the User or Admin password.
3. Press the **Home** icon to exit the Unlock parameter.

### Accessing the Device with Rolling Passwords Enabled

1. Go to **Operations — Factory — Unlock**.
2. Scroll to select **Public Key** and make note of the number displayed: \_\_\_\_\_
3. Plug that key and your User or Admin password into the appropriate formula to find the actual current passcode:
  - Rolling Password Formula for user passwords:  $(\text{Password} \times \text{Public Key}) \text{ Mod } 929 + 70 = \text{_____}$
  - Rolling Password Formula for admin passwords:  $(\text{Password} \times \text{Public Key}) \text{ Mod } 997 + 1000 = \text{_____}$ .
4. Press the Left Back Arrow to return to the **Factory - Unlock** List, and select **Password**.
5. Use the numeric slider to set the passcode just found.
6. Press the **Home** icon to exit.

---

## Modbus® - Using Programmable Memory Blocks

When using the Modbus® RTU or Modbus® TCP protocols, the PM control features a block of addresses that can be configured by the user to provide direct access to a list of 40 user configured parameters. This allows the user easy access to this customized list by reading from or writing to a contiguous block of registers.

See Appendix: Modbus Programmable Memory Blocks

When the Modbus® address of a target parameter is stored in an "Assembly Definition Address" its corresponding working address returns that parameter's value. If it's a writable parameter, writing to its working register will change the parameter value.

As an example, Modbus® register 360 represents the Analog Input 1 Process Value (See **Operations — Analog Input**). If the value 360 is loaded into Assembly Definition Address 90 and value 361 is loaded into Assembly Definition Address 91, the process value sensed by analog input 1 will also be stored in Modbus® registers 250 and 251. Notice that by default this parameter is also stored in working registers 240 and 241 as well.

When modifying the Modbus® Assembly registers, single register writes (function 06) are not allowed. Multiple register writes (function 16) must be used to modify the assembly.

The "Assembly Definition Addresses and Assembly Working Addresses" table reflects the assemblies and their associated addresses.

---

# CIP Communications: DeviceNet or EtherNet/IP

Common Industrial Protocol (CIP) is used to collect data, configure, and control the PM PLUS. CIP is an open protocol at the application layer fully managed by the Open DeviceNet Vendors Association (ODVA, <http://www.odva.org>). EtherNet/IP and DeviceNet use the same addressing scheme. EtherNet/IP is a network communication standard capable of handling large amounts of data at speeds of 10 Mbps or 100 Mbps, and at up to 1,500 bytes per packet. It makes use of standard off-the-shelf Ethernet chip sets and the currently installed physical media (hardware connections). DeviceNet can communicate at 125, 250 and 500 kilobytes per second with a maximum limitation of 64 nodes (0 to 63) on the network.

For implicit communications (real time I/O messaging) using a PLC, configure the PM PLUS™ assembly size into the I/O structure of the PLC (See: [CIP Implicit Assemblies Structures](#)). The assembly structures can be changed.

For explicit communications (information/configuration messaging), you'll need to use specific addressing information. DeviceNet requires the node address; EtherNet/IP requires the Class, Instance and Attribute.

- Node address or MAC ID (0 - 63, DeviceNet only)
- Class ID (1 to 255)
- Instance ID (0 to 255)
- Attribute ID (1 to 255)

The PM PLUS™ does not support connected explicit messages but fully supports unconnected explicit messaging.

NOTE: The maximum number of implicit input/output members using DeviceNet is 40. When using EtherNet/IP the maximum is 40.

## CIP Implicit Assemblies

PM PLUS™ may be purchased with DeviceNet or EtherNet/IP communications cards. Reading or writing when using CIP is accomplished via explicit and or implicit communications. Explicit communications are usually executed via a message instruction within the PLC but there are other ways to do this as well outside of the focus of this document.

Implicit communications is also commonly referred to as polled communications. When using implicit communications there is an I/O assembly that would be read or written to. The default assemblies and the assembly size is embedded into the firmware of the PM control. Watlow refers to these assemblies as the T to O (Target to Originator) and the O to T (Originator to Target) assemblies where the Target is always the controller and the Originator is the PLC or master on the network. The size of the O to T assembly is initially set to 40 (32-bit) members where the T to O assembly consists of 40 (32-bit) members. All assembly members are user configurable with the exception of the first T to O member. The first member of the T to O assembly is called the Device Status, it is unique and cannot be changed. If the module has been properly configured when viewing this 32-bit member in binary format bits 12 and 16 should always be set to 1 where all of the other bits should be 0. All other members that follow Device Status are user configurable.

If the control is brought back to the factory default [CIP Implicit Assembly Structures](#) the user configured assemblies will be overwritten.

## Compact Assembly Class

Along with the standard implicit assembly where each module parameter (member) occupies one 32-bit assembly location, there is also a Compact Class assembly. The need for the Compact Class assembly members became apparent as the number of member instances grew with the EZ-ZONE family of controls. Because there is a limited number of implicit assembly members (40 input, 40 output), the Compact Class enables the user to modify the standard assembly offering to their liking while also achieving much better utilization of each bit within the 32-bit member. As an example, if a standard Implicit Assembly member were configured to monitor Alarm State 1, the entire 32-bit member would be consumed where just 7 bits out of the 32 represent: Startup (88), None (61), Blocked (12), Alarm Low (8), Alarm High (7) or Error (28). With Compact Class assembly member 12 (identified in this document as "[12 A, Alarm Read](#)") in use, the alarm states of all 4 alarms can be placed in one 32-bit assembly member using just 2 bits for each state. Bits 0 and 1 would represent Alarm State 1, bits 2 and 3 Alarm State 2, etc... Each pair of 2 bits can represent the following states: 00 = None, 01 = Alarm Low, 10 = Alarm High and 11 = Other. There is a variety of predefined Compact Class members that can be used (See Appendix: [Compact Class Assembly Structure](#)) to modify the default implicit assemblies.

As is the case with any available parameter within the PM control, the Compact Class members can also be read or written to individually via an explicit message as well.

## Modifying Implicit Assembly Members

To change any given member of either assembly (T to O or O to T) simply write the new class, instance and attribute (CIA) to the member location of choice. As an example, if it were desired to change the 14<sup>th</sup> member of the T to O assembly from the default parameter (Cool Power) to the Compact Class 12<sup>th</sup> member (See Appendix: [Compact Class Assembly Structure](#)) write the value of 0x71, 0x01 and 0x0C (Class, Instance and Attribute respectively) to 0x77, 0x02 and 0x0D. Once the change is executed, reading this member location (as was discussed above) will return the Alarm States (1-4) to paired bits 0 through 7 where 00 = None, 01 = Alarm Low, 10 = Alarm High and 11 = Other. The CIP communications instance will always be instance 2.

---

## PCCC - (Programmable Controller Communications Commands)

This protocol is typically used with older Allen Bradley programmable controllers capable of PLC-5 compatibility. The PM PLUS™ has 2 assemblies; one for input (O to T), and the other for output (T to O). As viewed and accessed using Rockwell software, these PM PLUS™ assemblies can be identified as N11:0 (O to T) and N10:0 (T to O).

Refer to the Appendix: CIP Implicit Assembly Structures.

Example: If an ML1100 is used to write a new Set Point to the PM PLUS, a message instruction needs to be setup within the PLC to send a floating point value to N11:2. Likewise, if you want to read the Analog Input Value from the PM PLUS™ (from the PLC), a message instruction would need to be set up to read register N10:1 and then handled appropriately within the PLC because this is a floating point value in the PM controller.

Most, if not all older PLCs support CIP generic messaging. It would be worth your while to see if the PLC in use supports CIP to minimize programming effort. Using CIP allows for reads and writes to/from the PLC directly to the desired CIP address within the PM PLUS. All available PM PLUS™ CIP addresses are documented within this user guide for each of the PM PLUS™ Lists/Parameters.

---

# Profibus DP (Decentralized Peripherals)

This protocol is typically used to operate sensors and actuators via a centralized controller within industrialized production topologies. Data rates up to 12 Mbit/s on twisted pair cables and/or fiber optics are possible. Profibus versions DP-V0 and DP-V1 are supported on Watlow devices that use Profibus DP.

DP-V0 provides basic DP functionality, including cyclic data exchange, station, module and channel specific diagnostics and four different interrupt types for diagnostics and process interrupts. To use DP-V0, you'll first configure and then register the General Station Description (GSD) file using our [Profibus GSD Editor](#). With the GSD Editor, you can configure up to 244 I/O bytes that can be read or written to from Zone 1 through 16.

DP-V1 includes acyclic data communication for parameter assignment, operation, visualization and interrupt control of intelligent field devices, in conjunction with cyclic user data communication.

<p>NOTE: Download our Profibus GSD Editor from our website by searching "GSD" at <a href="http://www.watlow.com/en/resources-and-support/Technical-Library/Software-and-Demos">http://www.watlow.com/en/resources-and-support/Technical-Library/Software-and-Demos</a>.</p>
---



# Chapter 9: Applications

## Example 1: Single Loop Control

Requirements: One input is required and at least one output adjusts the controlled part of the process.

Overview: Controls one process value to a user entered Set Point based on an control algorithm.

Control loop 1 will control Analog Input 1 to Set Point 1.

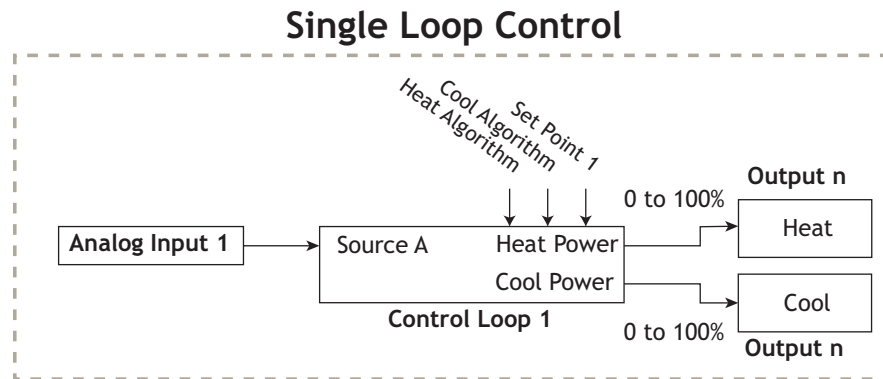

## Example 2: Sensor Backup

Requirements: Two analog inputs and the enhanced software option are required and at least one output adjusts the controlled part of the process.

Overview: The Sensor Backup feature controls a process based on a primary sensor on Analog Input 1. If this sensor fails, then the process is controlled based on the secondary sensor on Analog Input 2.

When function is set for Sensor Backup, the PV Function output equals Source A if sensor of Analog Input 1 reading is valid or Source B if sensor reading if Analog Input 1 is invalid, and Analog Input 2 is valid. Control loop 1 will control the valid Analog Input sensor to Set Point 1.

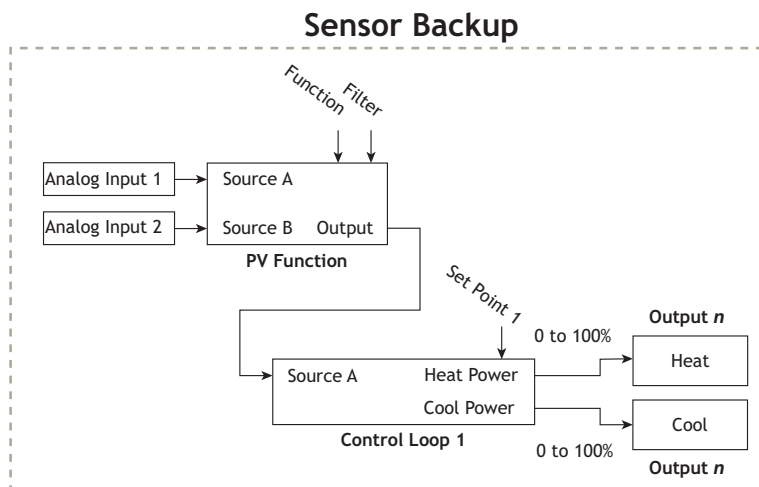

# Example 3: Square Root

Requirements: One analog input and the enhanced software option and at least one output adjusts the controlled part of the process.

Overview: Calculates the square root value of the sensor connected to Analog Input 1.

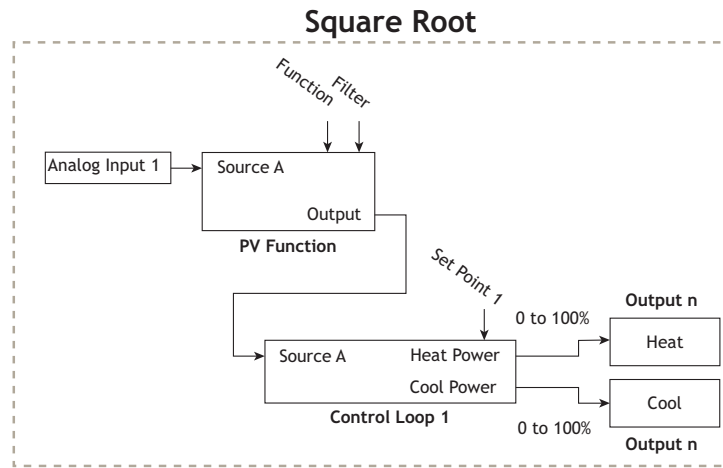

When function is set for Square Root, the PV Function output equals square root value of Source A. Control loop 1 will control Analog Input 1 to Set Point 1.

# Example 4: Ratio

Requirements: Two analog inputs and the enhanced software option are required and at least one output adjusts the controlled part of the process.

Overview: The Ratio feature allows control of one process as a ratio of another process. This is especially useful in applications that mix two materials, whether steam, paint or food ingredients. Analog Input 1 monitors the controlled part of the process. Analog Input 2 of the controller measures the part of the process that is either uncontrolled or controlled by another device. The part of the process controlled will be maintained at a level equal to the quantity measured at input 2 multiplied by the ratio term set by the user as Set Point 1. When function is set for Ratio, the PV Function output equals Source A as a ratio to Source B. Control loop 1 will control Analog Input 1 to Set Point 1.

Applications of ratio control:

Blending two or more flows to produce a mixture with specified composition.

Blending two or more flows to produce a mixture with specified physical properties.

Maintaining correct air and fuel mixture to combustion.

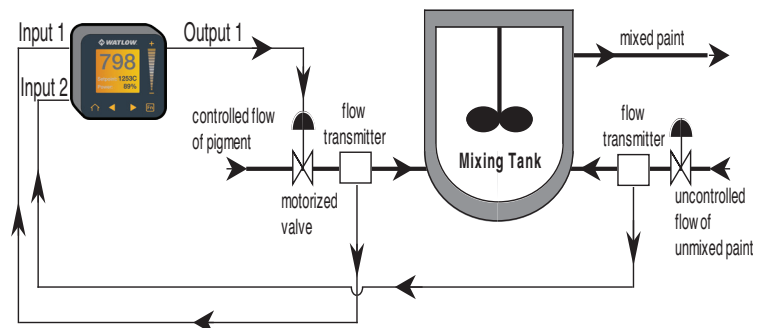

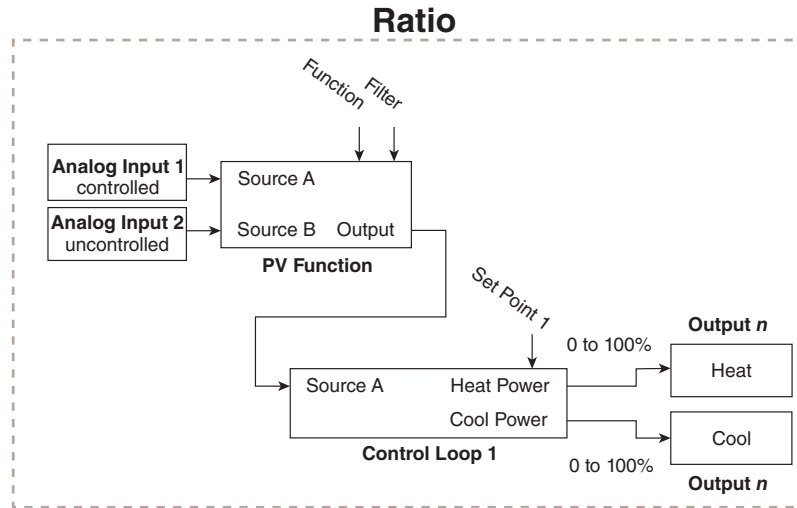

## Example 5: Differential

Requirements: Two analog inputs and the enhanced software option are required and at least one output adjusts the controlled part of the process.

Overview: Differential control maintains one process at a difference to another process. When function is set for Differential, the PV Function output equals Source A minus Source B. Control loop 1 will control Analog Input 1 difference to Analog Input 2 based on Set Point 1.

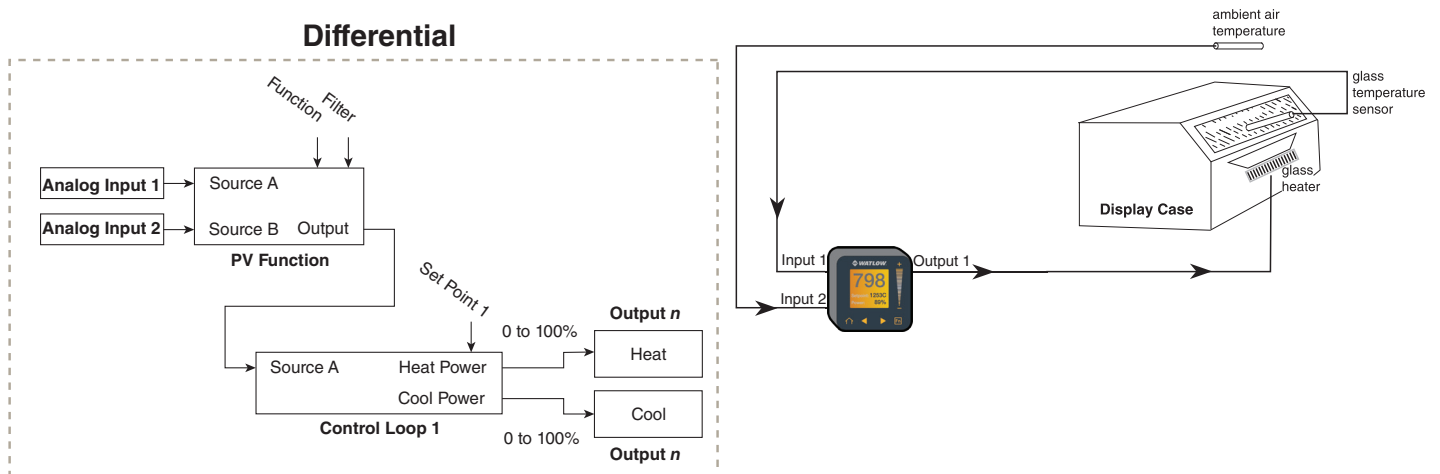

# Example 6: Wet Bulb / Dry Bulb

Requirements: Two analog inputs and at least one output are required to adjust the controlled part of the processes.

Overview:

Wet Bulb/Dry Bulb is a configuration where a dry bulb connected to Analog Input 1 measures temperature on Analog Input 1. A wet bulb sensor that is maintained with moisture has air moved over the sensor. As moisture evaporates from the wet bulb, the temperature drops. A wet bulb input on Analog Input 2, in combination with the dry bulb temperature, senses relative humidity. The controller calculates the temperature difference between the two sensors to determine percent relative humidity. The humidify and dehumidify outputs are disabled when Analog Input 1 temperature falls below 32 F/0 C, or goes above 212 F/100 C. When function is set for Wet Bulb/Dry Bulb, the PV Function output equals calculated humidity. Control loop 1 will control Analog Input 1 to Set Point 1. Control loop 2 will control Analog Input 2 to Set Point 2.

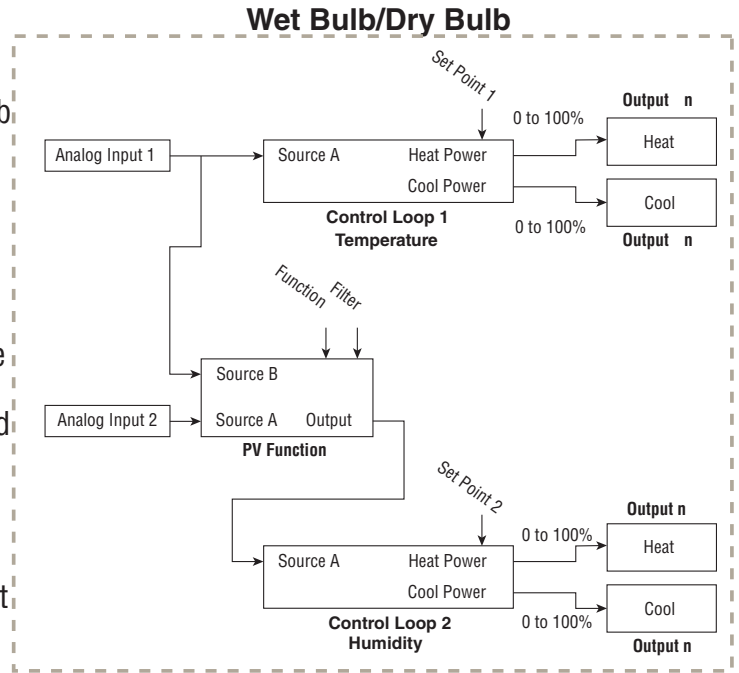

# Example 7: Vaisala

Requirements: Two analog inputs and the enhanced software option are required and at least two outputs adjust the controlled temperature and humidity processes.

Overview: Vaisala Model HMM-30C Solid-state Relative Humidity Sensor is supported with the Vaisala configuration. Analog Input 1 is used to measure temperature and Analog Input 2 must be a process input connected to a Vaisala sensor. The controller provides temperature compensation for the Vaisala sensor. The humidity and dehumidify outputs are disabled when Analog Input 1 temperature falls below -40 F/- 40 C, or goes above 320 F/160 C. When function is set for Vaisala, the PV Function output equals the calculated relative humidity compensated by the sensor on Analog Input 1.

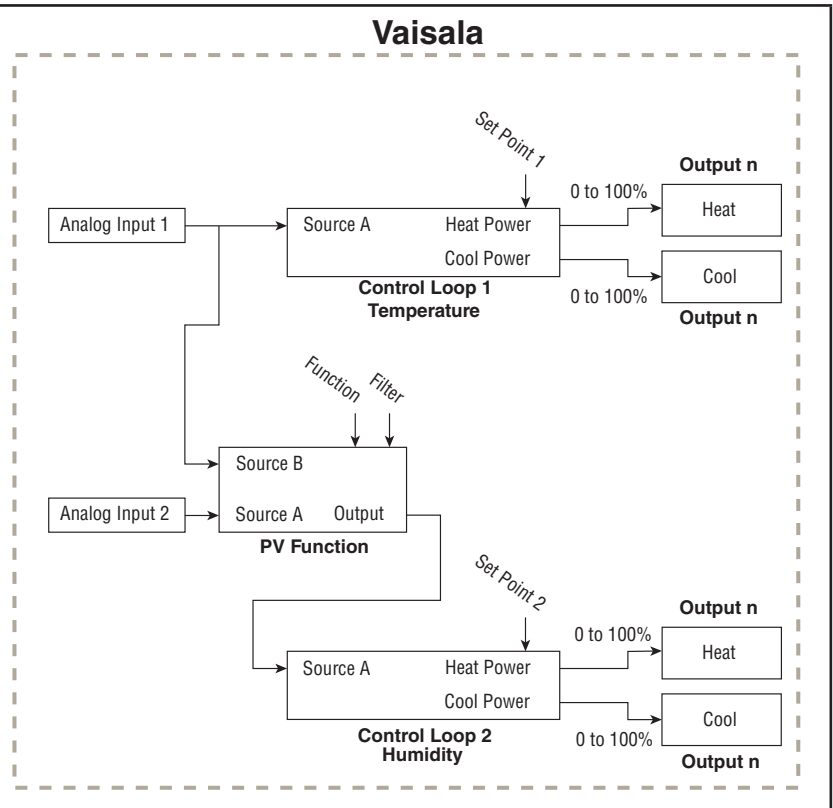

# Example 8: Motorized Valve Control

A typical scenario where a motorized valve is used is to regulate the flow of fluid which impacts the loop process value. A valve is opened or closed by closing contacts to drive the value in the intended direction.

The Motorized Valve control algorithm is designed to work with a type of valve that provides two discrete signals: one to open the valve and another to close the valve. The algorithm turns on/off the appropriate signal for an appropriate amount of time to approximate the valve position. This works when the valve is inside a closed control loop because when the valve is not in the correct position, the PID algorithm will adjust the valve further open or close as needed. These valves have travel limit switches which deactivates the motor once the valve is fully open or fully closed so the controller can not cause the valve to over travel and burn out the motor, or the motor is built so it can not overheat at max locked rotor amperes.

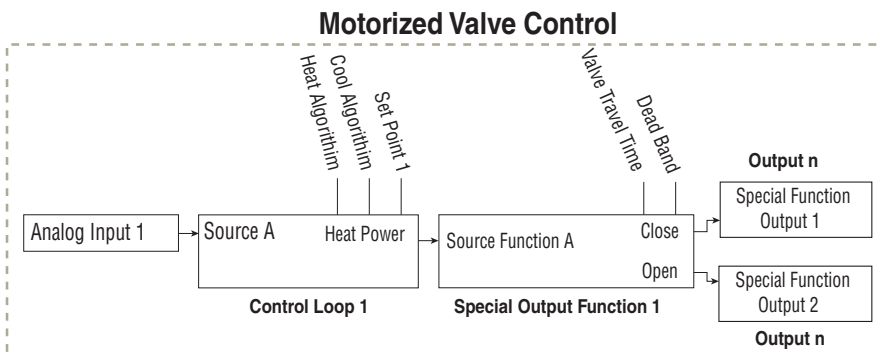

To use the motorized feature:

1. Program the Special Output Function to Motorized Valve.
2. Set Source Function A to either Heat or Cool Power and set Source Instance A to match the control loop, typically 1.
3. Enter the amount of time in seconds that the valve requires power to go from a closed state to an open state. Enters the dead band in percent PID power to prevent the valve from excessive cycling. Larger numbers reduce activity on the valve and smaller numbers improve controllability. Select a value that compromises on these two competing goals.
4. Assign an output to Special Output Function 1 that is wired to close the valve. Assign an output to Special Output Function 2 that is wired to open the valve. Typically, these two outputs are normally open mechanical relays but solid state relays or switch DC outputs may be programmed in the same manner.

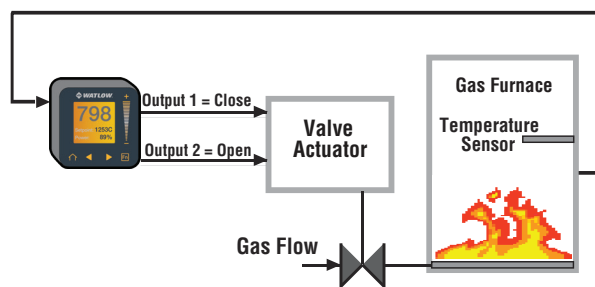

Definitions:

- Current Position is an approximation of the valve's position as it relates to a power level (0 - 100%) where 0% is fully closed and 100% is fully open.
- Dead Time is the minimum on time that the valve will travel once it is turned on in either the closed or open direction.  $Dead\ Time = Valve\ Dead\ Band / 100 * Valve\ Travel\ Time.$
- Valve Travel Time is the amount of time the valve needs to be turned on (either open or close) to eliminate the error between the estimated valve position and the desired power level. A positive On Time value indicates the need to open the valve while a negative value indicates the need to close the valve.  $On\ Time = (Input\ 1\ Value - Current\ Position) / 100 * Valve\ Travel\ Time$

When power is applied to the controller, the valve is closed and time is set to 0.

- Special Output Function 1 is the close signal to the valve.
- Special Output Function 2 is the open signal to the valve.

# Chapter 10: Appendix

## Troubleshooting Alarms, Errors and Control Issues

Indication	Issue	Issue / Possible Cause(s)	Corrective Action
Alarm won't clear or reset	Alarm will not clear or re-set with keypad or digital input	<ul style="list-style-type: none"> <li>Alarm will not clear or reset via device or digital input.</li> <li>Latching is active</li> <li>Alarm set to incorrect output</li> <li>Alarm is set to incorrect source</li> <li>Sensor input is out of alarm set point range</li> <li>Alarm set point is incorrect</li> <li>Alarm is set to incorrect type</li> <li>Digital input function is incorrect</li> </ul>	<ul style="list-style-type: none"> <li>Reset alarm when process is within range or disable latching</li> <li>Set output to correct alarm source instance</li> <li>Set alarm source to correct input instance</li> <li>Correct cause of sensor input out of alarm range</li> <li>Set alarm set point to correct trip point</li> <li>Set alarm to correct type: process, deviation or power</li> <li>Set digital input function and source instance</li> </ul>
Alarm won't occur	Alarm will not activate output	<ul style="list-style-type: none"> <li>Silencing is active</li> <li>Blocking is active</li> <li>Alarm is set to incorrect output</li> <li>Alarm is set to incorrect source</li> <li>Alarm set point is incorrect</li> <li>Alarm is set to incorrect type</li> </ul>	<ul style="list-style-type: none"> <li>Disable silencing, if required</li> <li>Disable blocking, if required</li> <li>Set output to correct alarm source instance</li> <li>Set alarm source to correct input instance</li> <li>Set alarm set point to correct trip point</li> <li>Set alarm to correct type: process, deviation or power</li> </ul>
Alarm Error 1 Alarm Error 2 Alarm Error 3 Alarm Error 4	Alarm state cannot be determined due to lack of sensor input	<ul style="list-style-type: none"> <li>Sensor improperly wired or open</li> <li>Incorrect setting of sensor type</li> <li>Calibration corrupt</li> </ul>	<ul style="list-style-type: none"> <li>Correct wiring or replace sensor</li> <li>Match setting to sensor used</li> <li>Check calibration of controller</li> </ul>
Alarm Low [1,2,3,4]	Sensor input below low alarm set point	<ul style="list-style-type: none"> <li>Temperature is less than alarm set point</li> <li>Alarm is set to latching and an alarm occurred in the past</li> <li>Incorrect alarm set point</li> <li>Incorrect alarm source</li> </ul>	<ul style="list-style-type: none"> <li>Check cause of under temperature</li> <li>Clear latched alarm</li> <li>Establish correct alarm set point</li> <li>Set alarm source to proper setting</li> </ul>
Alarm High [1,2,3,4]	Sensor input value is above high alarm set point	<ul style="list-style-type: none"> <li>Temperature is greater than alarm set point</li> <li>Alarm is set to latching and an alarm occurred in the past</li> <li>Incorrect alarm set point</li> <li>Incorrect alarm source</li> </ul>	<ul style="list-style-type: none"> <li>Check cause of over temperature</li> <li>Clear latched alarm</li> <li>Establish correct alarm set point</li> <li>Set alarm source to proper setting</li> </ul>
Error Input [1,2]	Sensor does not provide a valid signal to controller	<ul style="list-style-type: none"> <li>There is no valid signal to the device. The sensor may be improperly wired or open.</li> <li>Incorrect setting of sensor type</li> <li>Calibration corrupt</li> </ul>	<ul style="list-style-type: none"> <li>Correct wiring or replace sensor</li> <li>Match setting to sensor used</li> <li>Check calibration of controller</li> </ul>

Indication	Issue	Issue / Possible Cause(s)	Corrective Action
Ambient Error	Sensor does not provide a valid signal to controller	<ul style="list-style-type: none"> <li>Ambient error - cold junction circuitry not working</li> </ul>	<ul style="list-style-type: none"> <li>Return to factory for repair</li> </ul>
Limit won't clear or reset	Limit will not clear or reset with keypad or digital input	<ul style="list-style-type: none"> <li>Sensor input is out of limit set point range</li> <li>Limit set point is incorrect</li> <li>Digital input function is incorrect</li> </ul>	<ul style="list-style-type: none"> <li>Correct cause of sensor input out of limit range</li> <li>Set limit set point to correct trip point</li> <li>Set digital input function and source instance</li> </ul>
Limit Error	Limit state cannot be determined due to lack of sensor input, limit will trip	<ul style="list-style-type: none"> <li>Sensor improperly wired or open</li> <li>Incorrect setting of sensor type</li> <li>Calibration corrupt</li> </ul>	<ul style="list-style-type: none"> <li>Correct wiring or replace sensor</li> <li>Match setting to sensor used</li> <li>Check calibration of controller</li> </ul>
Limit Low	Sensor input below low limit set point	<ul style="list-style-type: none"> <li>Temperature is less than limit set point</li> <li>Limit outputs latch and require reset</li> <li>Incorrect limit set point</li> </ul>	<ul style="list-style-type: none"> <li>Check cause of under temperature</li> <li>Clear limit</li> <li>Establish correct limit set point</li> </ul>
Limit High	Sensor input above high limit set point	<ul style="list-style-type: none"> <li>Temperature is greater than limit set point</li> <li>Limit outputs latch and require reset</li> <li>Incorrect limit set point</li> </ul>	<ul style="list-style-type: none"> <li>Check cause of over temperature</li> <li>Clear limit</li> <li>Establish correct limit set point</li> </ul>
Loop Open Error [1,2]	Open Loop Detect is active and the process value did not deviate by a user-selected value in a user specified period with PID power at 100%.	<ul style="list-style-type: none"> <li>Setting of Open Loop Detect Time incorrect</li> <li>Setting of Open Loop Detect Deviation incorrect</li> <li>Thermal loop is open</li> <li>Open Loop Detect function not required but activated</li> </ul>	<ul style="list-style-type: none"> <li>Set correct Open Loop Detect Time for application</li> <li>Set correct Open Loop Deviation value for application</li> <li>Determine cause of open thermal loop: misplaced sensors, load failure, loss of power to load, etc.</li> <li>Deactivate Open Loop Detect feature</li> </ul>
Loop Reversed Error [1,2]	Open Loop Detect is active and the process value is headed in the wrong direction when the output is activated based on deviation value and user-selected value.	<ul style="list-style-type: none"> <li>Setting of Open Loop Detect Time incorrect</li> <li>Setting of Open Loop Detect Deviation incorrect</li> <li>Output programmed for incorrect function</li> <li>Thermocouple sensor wired in reverse polarity</li> </ul>	<ul style="list-style-type: none"> <li>Set correct Open Loop Detect Time for application</li> <li>Set correct Open Loop Deviation value for application</li> <li>Set output function correctly</li> <li>Wire thermocouple correctly, (red wire is negative)</li> </ul>
Ramping [1,2]	Controller is ramping to new set point	<ul style="list-style-type: none"> <li>Ramping feature is activated</li> </ul>	<ul style="list-style-type: none"> <li>Disable ramping feature if not required</li> </ul>
Autotuning [1,2]	Controller is autotuning the control loop	<ul style="list-style-type: none"> <li>User started the autotune function</li> <li>Digital input is set to start autotune</li> </ul>	<ul style="list-style-type: none"> <li>Wait until autotune completes or disable autotune feature</li> <li>Set digital input to function other than autotune, if desired</li> </ul>

Indication	Issue	Issue / Possible Cause(s)	Corrective Action
No heat/cool action	Output does not activate load	<ul style="list-style-type: none"> <li>• Output function is incorrectly set</li> <li>• Control mode is incorrectly set</li> <li>• Output is incorrectly wired</li> <li>• Load, power or fuse is open</li> <li>• Control set point is incorrect</li> <li>• Incorrect controller model for application</li> </ul>	<ul style="list-style-type: none"> <li>• Set output function correctly</li> <li>• Set control mode appropriately (Open vs Closed Loop)</li> <li>• Correct output wiring</li> <li>• Correct fault in system</li> <li>• Set control set point in appropriate control mode and check source of set point: remote, idle, profile, closed loop, open loop</li> <li>• Obtain correct controller model for application</li> </ul>
No Display	No display indication or LED illumination	<ul style="list-style-type: none"> <li>• Power to controller is off</li> <li>• Fuse open</li> <li>• Breaker tripped</li> <li>• Safety interlock switch open</li> <li>• Separate system limit control activated</li> <li>• Wiring error</li> <li>• Incorrect voltage to controller</li> </ul>	<ul style="list-style-type: none"> <li>• Turn on power</li> <li>• Replace fuse</li> <li>• Reset breaker</li> <li>• Close interlock switch</li> <li>• Reset limit</li> <li>• Correct wiring issue</li> <li>• Apply correct voltage, check part number</li> </ul>
No Serial Communication	Cannot establish serial communications with the controller	<ul style="list-style-type: none"> <li>• Address parameter incorrect</li> <li>• Incorrect protocol selected</li> <li>• Baud rate incorrect</li> <li>• Parity incorrect</li> <li>• Wiring error</li> <li>• EIA-485 converter issue</li> <li>• Incorrect computer or PLC communications port</li> <li>• Incorrect software setup</li> <li>• Wires routed with power cables</li> <li>• Termination resistor may be required</li> </ul>	<ul style="list-style-type: none"> <li>• Set unique addresses on network</li> <li>• Match protocol between devices</li> <li>• Match baud rate between devices</li> <li>• Match parity between devices</li> <li>• Correct wiring issue</li> <li>• Check settings or replace converter</li> <li>• Set correct communication port</li> <li>• Correct software setup to match controller</li> <li>• Route communications wires away from power wires</li> <li>• Place 120 <math>\Omega</math> resistor across EIA-485 on last controller</li> </ul>
Process doesn't control to set point	Process is unstable or never reaches set point	<ul style="list-style-type: none"> <li>• Controller not tuned correctly</li> <li>• Control mode is incorrectly set</li> <li>• Control set point is incorrect</li> </ul>	<ul style="list-style-type: none"> <li>• Perform autotune or manually tune system</li> <li>• Set control mode appropriately (Open vs Closed Loop)</li> <li>• Set control set point in appropriate control mode and check source of set point: remote, idle, profile, closed loop, open loop</li> </ul>
Temperature runaway	Process value continues to increase or decrease past set point.	<ul style="list-style-type: none"> <li>• Controller output incorrectly programmed</li> <li>• Thermocouple reverse wired</li> <li>• Controller output wired incorrectly</li> <li>• Short in heater</li> <li>• Power controller connection to controller defective</li> <li>• Controller output defective</li> </ul>	<ul style="list-style-type: none"> <li>• Verify output function is correct (heat or cool)</li> <li>• Correct sensor wiring (red wire negative)</li> <li>• Verify and correct wiring</li> <li>• Replace heater</li> <li>• Replace or repair power controller</li> <li>• Replace or repair controller</li> </ul>
Device Error	Controller displays internal malfunction message at power up.	<ul style="list-style-type: none"> <li>• Controller defective</li> <li>• Sensor input over driven</li> </ul>	<ul style="list-style-type: none"> <li>• Replace or repair controller</li> <li>• Check sensors for ground loops, reverse wiring or out of range values.</li> </ul>



Indication	Issue	Issue / Possible Cause(s)	Corrective Action
Heater Error	Heater Error	<ul style="list-style-type: none"> <li>• Current through load is above current trip set point</li> <li>• Current through load is below current trip set point</li> </ul>	<ul style="list-style-type: none"> <li>• Check that the load current is proper. Correct cause of over current and/or ensure current trip set point is correct.</li> <li>• Check that the load current is proper. Correct cause of undercurrent and/or ensure current trip set point is correct.</li> </ul>
Current Error	Load current incorrect.	<ul style="list-style-type: none"> <li>• Shorted solid-state or mechanical relay</li> <li>• Open solid-state or mechanical relay</li> <li>• Current transformer load wire associated to wrong output</li> <li>• Defective current transformer or controller</li> <li>• Noisy electrical lines</li> </ul>	<ul style="list-style-type: none"> <li>• Replace relay</li> <li>• Replace relay</li> <li>• Route load wire through current transformer from correct output, and go to the <b>5.5</b>, Source Output Instance parameter (Setup Page, Current Menu) to select the output that is driving the load.</li> <li>• Replace or repair sensor or controller</li> <li>• Route wires appropriately, check for loose connections, add line filters</li> </ul>
Menus inaccessible	Unable to access Setup, <b>Operations</b> , Factory, or Profile Lists	<ul style="list-style-type: none"> <li>• Security set to incorrect level</li> <li>• Digital input set to lockout keypad</li> <li>• Custom parameters incorrect</li> </ul>	<ul style="list-style-type: none"> <li>• Check <b>Operations - Factory - Lock</b> settings and enter appropriate password in <b>Factory - Unlock</b>.</li> <li>• Change state of digital input</li> </ul>
Function key does not work	Function key does not activate required function	<ul style="list-style-type: none"> <li>• Function incorrect</li> <li>• Function instance not correct</li> <li>• Keypad malfunction</li> </ul>	<ul style="list-style-type: none"> <li>• Verify Function in the Setup Menu</li> <li>• Correct and change the function instance if not correct</li> <li>• Replace or repair controller</li> </ul>
Displayed value too low	Value too low to be displayed in 4 digit LED display <-1999	<ul style="list-style-type: none"> <li>• Incorrect setup</li> </ul>	<ul style="list-style-type: none"> <li>• Check scaling of source data</li> </ul>
Displayed value too high	Value too high to be displayed in 4 digit LED display >9999	<ul style="list-style-type: none"> <li>• Incorrect setup</li> </ul>	<ul style="list-style-type: none"> <li>• Check scaling of source data</li> </ul>

Detection of and Rules Around Abnormal Sensor Conditions	
Inputs	Detection of Abnormal Conditions
<b>Thermocouple</b>	
Shorted	No direct detection, Open loop firmware detection.
Open	Yes, Parasitic pull-up
Reversed	Yes, firmware detection
<b>Current Source</b>	
Shorted	Range limiting only
Open	Range limiting only
Reversed	Range limiting only
<b>Voltage Source</b>	
Open	Range limiting only
Shorted	Range limiting only
Reversed	Range limiting only
<b>RTD</b>	
S1 open	Yes, pulled up.
S2 open	Not implemented.
S3 open	Yes, pulled up.
S1 short to S2	Yes, pulled up
S1 short to S3	Yes, pulled down to under range.
S2 shorted to S3	Not implemented, Possible, monitor S2 voltage.
S1 and S2 open	Yes, pulled down to under range.
S1 and S3 open	Yes, S1 pulled up.
S2 and S3 open	Yes pulled up.
<b>Thermistor</b>	
S1 open	Yes, pulled up to sensor over range.
S3 open	Yes, pulled up to sensor over range.
S1 short to S3	Yes, pulled down to sensor under range.
S1 and S3 open	Yes, S1 pulled up to sensor over range.

# Modbus® Programmable Memory Blocks

The Modbus® assembly or programmable memory blocks consists of 40 pointers to the parameters of your choosing starting at Modbus® register 40 (shown on the following page). The pointers are 32-bits long and are stored in two sequential registers. As an example, to move an alias to the analog input of the PM (register 360) into pointer registers 40 and 41, a single multi-write command (0x10 function) would be used writing 360 into register 40 and 361 into register 41.

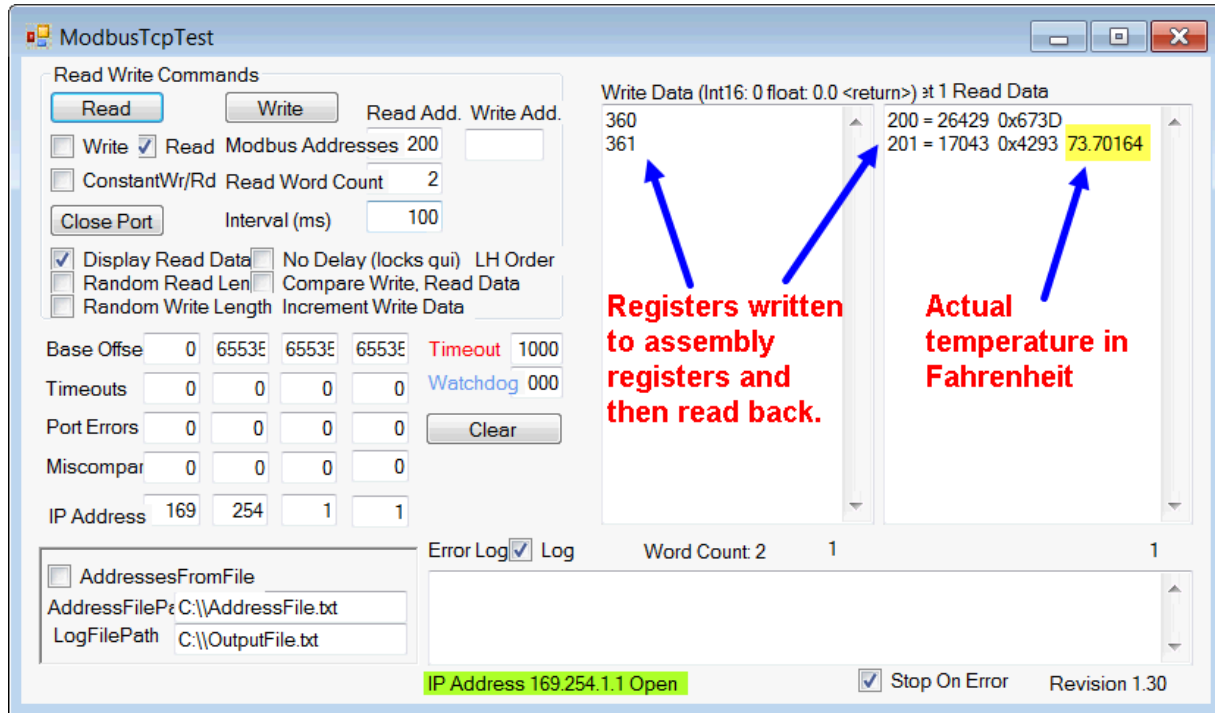

The screen shot above was taken from a Watlow application called "Modbus® TCP Diagnostic Program for EZ-ZONE PM, RM and ST", which can be found at <http://www.watlow.com/en/resources-and-support/Technical-Library/Software-and-Demos> by searching "Modbus®."

Once the parameters have been defined and written to the specified pointer registers, the working registers will then represent the parameters written. In the example here, the 32-bit floating point analog input (360 and 361) was first written to registers 40 and 41 which defines working registers 200 and 201 as Analog Input 1. As can be seen in the far right-hand column in the screenshot above, reading back registers 200 and 201, the temperature as detected by the first analog input is displayed.

Note: Modbus® allows a maximum of 125 16-bit registers to be read with one read command. That is 62 of the 32-bit registers defined here. Use two read commands to read the entire assembly if desired in one module. Each module has its own assembly and the assembly working addresses must be within the same module.

## Assembly Definition Addresses and Assembly Working Addresses

Pointer Registers	Working Registers
Assembly Definition Addresses are fixed addresses that define the parameter stored in "Working Addresses," also referred to as a pointer. The value stored in these addresses will point to the Modbus® address of a parameter within the PM control.	Assembly Working Addresses are fixed addresses that are directly related to their associated "Assembly Definition Addresses" (i.e., Assembly Working Addresses 200 & 201 will assume the parameter pointed to by Assembly Definition Addresses 40 & 41).
40 & 41	200 & 201
42 & 43	202 & 203
44 & 45	204 & 205
46 & 47	206 & 207
48 & 49	208 & 209
50 & 51	210 & 211
52 & 53	212 & 213
54 & 55	214 & 215
56 & 57	216 & 217
58 & 59	218 & 219
60 & 61	220 & 221
62 & 63	222 & 223
64 & 65	224 & 225
66 & 67	226 & 227
68 & 69	228 & 229
70 & 71	230 & 231
72 & 73	232 & 233
74 & 75	234 & 235
76 & 77	236 & 237
78 & 79	238 & 239
80 & 81	240 & 241
82 & 83	242 & 243
84 & 85	244 & 245
86 & 87	246 & 247
88 & 89	248 & 249
90 & 91	250 & 251
92 & 93	252 & 253
94 & 95	254 & 255
96 & 97	256 & 257
98 & 99	256 & 259
100 & 101	260 & 261
102 & 103	262 & 263
104 & 105	264 & 265
106 & 107	266 & 267
108 & 109	268 & 269
110 & 111	270 & 271
112 & 113	272 & 273
114 & 115	274 & 275
116 & 117	276 & 277
118 & 119	278 & 279

# Modbus® Map 1 Default Assembly Structure 40-119

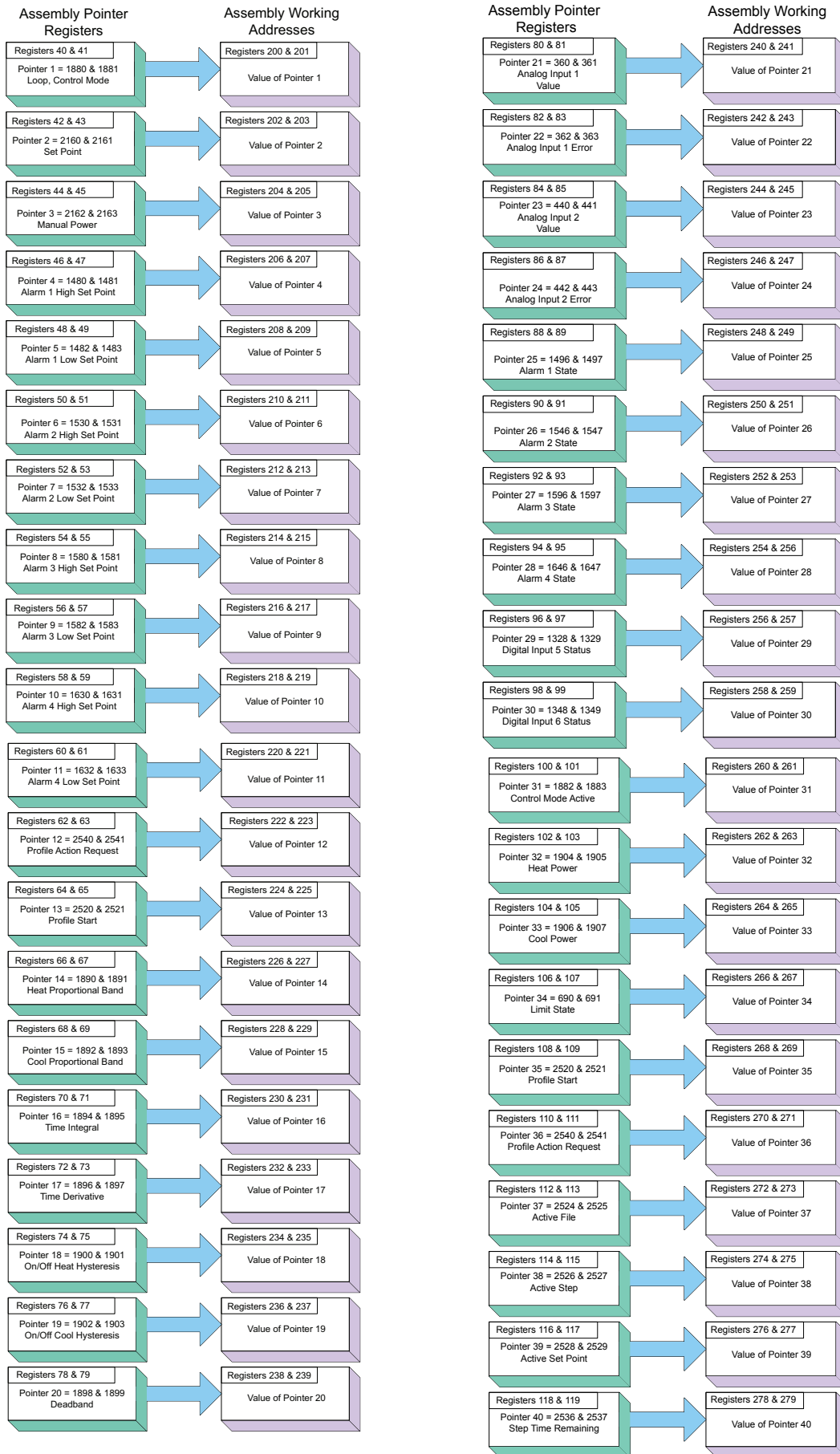

# CIP Implicit Assemblies

CIP Implicit Assembly Originator (Master) to Target (PM PLUS)					
Assembly Members	Assembly Class, Instance, Attribute	Data Type	Parameter	Parameter Class, Instance, Attribute	PLC Data Type
1	0x77, 0x01, 0x01	DINT	Loop 1 - Control Mode	0x97, 0x01, 0x01	DINT
2	0x77, 0x01, 0x02	DINT	Loop 1 - Set Point	0x6B, 0x01, 0x01	REAL
3	0x77, 0x01, 0x03	DINT	Loop 1 - Manual Power	0x6B, 0x01, 0x02	REAL
4	0x77, 0x01, 0x04	DINT	Alarm 1 - High Set Point	0x6D, 0x01, 0x01	REAL
5	0x77, 0x01, 0x05	DINT	Alarm 1 - Low Set Point	0x6D, 0x01, 0x02	REAL
6	0x77, 0x01, 0x06	DINT	Alarm 2 - High Set Point	0x6D, 0x02, 0x01	REAL
7	0x77, 0x01, 0x07	DINT	Alarm 2 - Low Set Point	0x6D, 0x02, 0x02	REAL
8	0x77, 0x01, 0x08	DINT	Alarm 3 - High Set Point	0x6D, 0x03, 0x01	REAL
9	0x77, 0x01, 0x09	DINT	Alarm 3 - Low Set Point	0x6D, 0x03, 0x02	REAL
10	0x77, 0x01, 0x0A	DINT	Alarm 4 - High Set Point	0x6D, 0x04, 0x01	REAL
11	0x77, 0x01, 0x0B	DINT	Alarm 4 - Low Set Point	0x6D, 0x04, 0x02	REAL
12	0x77, 0x01, 0x0C	DINT	Profile Action Request	0x7A, 0x01, 0x0B	DINT
13	0x77, 0x01, 0x0D	DINT	Profile Start	0x7A, 0x01, 0x01	DINT
14	0x77, 0x01, 0x0E	DINT	Loop 1 - Heat Proportional Band	0x97, 0x01, 0x06	REAL
15	0x77, 0x01, 0x0F	DINT	Loop 1 - Cool Proportional Band	0x97, 0x01, 0x07	REAL
16	0x77, 0x01, 0x10	DINT	Loop 1 - Time Integral	0x97, 0x01, 0x08	REAL
17	0x77, 0x01, 0x11	DINT	Loop 1 - Time Derivative	0x97, 0x01, 0x09	REAL
18	0x77, 0x01, 0x12	DINT	Loop 1 - Heat Hysteresis	0x97, 0x01, 0x0B	REAL
19	0x77, 0x01, 0x13	DINT	Loop 1 - Cool Hysteresis	0x97, 0x01, 0x0C	REAL
20	0x77, 0x01, 0x14	DINT	Loop 1 - Dead Band	0x97, 0x01, 0x0A	REAL
21	0x77, 0x02, 0x15	DINT	None Specified	----	----
22	0x77, 0x02, 0x16	DINT	None Specified	----	----
23	0x77, 0x02, 0x17	DINT	None Specified	----	----
24	0x77, 0x02, 0x18	DINT	None Specified	----	----
25	0x77, 0x02, 0x19	DINT	None Specified	----	----
26	0x77, 0x02, 0x1A	DINT	None Specified	----	----
27	0x77, 0x02, 0x1B	DINT	None Specified	----	----
28	0x77, 0x02, 0x1C	DINT	None Specified	----	----
29	0x77, 0x02, 0x1D	DINT	None Specified	----	----
30	0x77, 0x02, 0x1E	DINT	None Specified	----	----
31	0x77, 0x02, 0x1F	DINT	None Specified	----	----
32	0x77, 0x02, 0x20	DINT	None Specified	----	----
33	0x77, 0x02, 0x21	DINT	None Specified	----	----
34	0x77, 0x02, 0x22	DINT	None Specified	----	----
35	0x77, 0x02, 0x23	DINT	None Specified	----	----
36	0x77, 0x02, 0x24	DINT	None Specified	----	----
37	0x77, 0x02, 0x25	DINT	None Specified	----	----
38	0x77, 0x02, 0x26	DINT	None Specified	----	----
39	0x77, 0x02, 0x27	DINT	None Specified	----	----
40	0x77, 0x02, 0x28	DINT	None Specified	----	----

Although 40 members are built into PM controllers, the RUI allows for a maximum of 20.

CIP Implicit Assembly Target (PM PLUS) to Originator (Master)					
Assembly Members	Assembly Class, Instance, Attribute	Data Type	Parameter	Parameter Class, Instance, Attribute	PLC Data Type
- - - -	Cannot be changed	Binary	Device Status	None	BIN
1	0x77, 0x02, 0x01	DINT	Analog Input 1, Analog Input Value	0x68, 0x01, 0x01	REAL
2	0x77, 0x02, 0x02	DINT	Analog Input 1, Input Error	0x68, 0x01, 0x02	REAL
3	0x77, 0x02, 0x03	DINT	Analog Input 2, Analog Input Value	0x68, 0x02, 0x01	REAL
4	0x77, 0x02, 0x04	DINT	Analog Input 2, Input Error	0x68, 0x02, 0x02	REAL
5	0x77, 0x02, 0x05	DINT	Alarm 1, Alarm State	0x6D, 0x01, 0x09	DINT
6	0x77, 0x02, 0x06	DINT	Alarm 2, Alarm State	0x6D, 0x02, 0x09	DINT
7	0x77, 0x02, 0x07	DINT	Alarm 3, Alarm State	0x6D, 0x03, 0x09	DINT
8	0x77, 0x02, 0x08	DINT	Alarm 4, Alarm State	0x6D, 0x04, 0x09	DINT
9	0x77, 0x02, 0x09	DINT	Event Status 1	0x6E, 0x01, 0x05	DINT
10	0x77, 0x02, 0x0A	DINT	Event Status 2	0x6E, 0x02, 0x05	DINT
11	0x77, 0x02, 0x0B	DINT	Loop 1 - Control Mode Active	0x97, 0x01, 0x02	DINT
12	0x77, 0x02, 0x0C	DINT	Loop 1 - Heat Power	0x97, 0x01, 0x0D	REAL
13	0x77, 0x02, 0x0D	DINT	Loop 1 - Cool Power	0x97, 0x01, 0x0E	REAL
14	0x77, 0x02, 0x0E	DINT	Limit State	0x70, 0x01, 0x06	DINT
15	0x77, 0x02, 0x0F	DINT	Profile Start	0x7A, 0x01, 0x01	DINT
16	0x77, 0x02, 0x10	DINT	Profile Action Request	0x7A, 0x01, 0x0B	DINT
17	0x77, 0x02, 0x11	DINT	Current Profile	0x7A, 0x01, 0x03	DINT
18	0x77, 0x02, 0x12	DINT	Current Step	0x7A, 0x01, 0x04	DINT
19	0x77, 0x02, 0x13	DINT	Loop 1 - Active Set Point	0x7A, 0x01, 0x05	REAL
20	0x77, 0x02, 0x14	DINT	Step Time Remaining	0x7A, 0x01, 0x09	DINT
21	0x77, 0x02, 0x15	DINT	None Specified	- - - -	- - - -
22	0x77, 0x02, 0x16	DINT	None Specified	- - - -	- - - -
23	0x77, 0x02, 0x17	DINT	None Specified	- - - -	- - - -
24	0x77, 0x02, 0x18	DINT	None Specified	- - - -	- - - -
25	0x77, 0x02, 0x19	DINT	None Specified	- - - -	- - - -
26	0x77, 0x02, 0x1A	DINT	None Specified	- - - -	- - - -
27	0x77, 0x02, 0x1B	DINT	None Specified	- - - -	- - - -
28	0x77, 0x02, 0x1C	DINT	None Specified	- - - -	- - - -
29	0x77, 0x02, 0x1D	DINT	None Specified	- - - -	- - - -
30	0x77, 0x02, 0x1E	DINT	None Specified	- - - -	- - - -
31	0x77, 0x02, 0x1F	DINT	None Specified	- - - -	- - - -
32	0x77, 0x02, 0x20	DINT	None Specified	- - - -	- - - -
33	0x77, 0x02, 0x21	DINT	None Specified	- - - -	- - - -
34	0x77, 0x02, 0x22	DINT	None Specified	- - - -	- - - -
35	0x77, 0x02, 0x23	DINT	None Specified	- - - -	- - - -
36	0x77, 0x02, 0x24	DINT	None Specified	- - - -	- - - -
37	0x77, 0x02, 0x25	DINT	None Specified	- - - -	- - - -
38	0x77, 0x02, 0x26	DINT	None Specified	- - - -	- - - -
39	0x77, 0x02, 0x27	DINT	None Specified	- - - -	- - - -
40	0x77, 0x02, 0x28	DINT	None Specified	- - - -	- - - -

The first T to O member above (Device Status) is always present but not counted when configuring the gateway size using the RUI or EZ-ZONE Configurator software. However, it must always be counted when configuring the input size of the Master. As an example, if using the DINT comm format in a PLC and the entire assembly as shown above, the input size would require 41 members.

Although 40 members are built into PM controllers, the RUI allows for a maximum of 20.

The PM PLUS™ Implicit Assembly defaults to a populated assembly structure for the first 20 members. If it is desired to modify any of the given assembly members, visit <http://www.watlow.com/en/resources-and-support/Technical-Library/Software-and-Demos>, search "implicit," to find "EZ-ZONE Implicit Message Assembly Programming Application." For help, refer to the document, "Modifying Implicit Assembly Members," which can also be found <http://www.watlow.com/en/resources-and-support/Technical-Library>

# PM PLUS Integrated PID Controller Configuration Code



① ②	③	④	⑤	⑥ ⑦	⑧	⑨	⑩ ⑪	⑫	⑬ ⑭
PM	Package Size	Primary Functions	Power Supply Digital I/O	Output 1 and 2 Hardware Options	Comm. Options	Auxiliary Control Functions	Output 3 and 4 Hardware Options	Model Selection	Custom Options

③ Package Size	
6 =	1/16 DIN
8 =	1/8 DIN (vertical)
9 =	1/8 DIN (horizontal)

④ Primary Functions	
C =	PID controller with universal input
B =	PID controller with universal input and profiling ramp/soak and battery back-up with real time clock
E =	PID controller with thermistor input and profiling ramp/soak and battery back-up with real time clock
R =	PID controller with universal input and profiling ramp/soak
T =	PID controller with universal input and countdown timer
J =	PID controller with thermistor input
N =	PID controller with thermistor input and profiling ramp/soak
<b>Note:</b> Options B and E are not available with 1/16 DIN (PM6) models	

⑤ Power Supply, Digital Inputs/Outputs (I/O)	
1 =	100 to 240VAC
2 =	100 to 240VAC plus 2 digital I/O points
3 =	20 to 28VAC or 12 to 40VDC
4 =	20 to 28VAC or 12 to 40VDC, plus 2 digital I/O points

⑥ ⑦ Output 1 and 2 Hardware Options		
	Output 1	Output 2
CA =	Switched dc/open collector	None
CH =	Switched dc/open collector	NO-ARC 15A power control
CC =	Switched dc/open collector	Switched dc
CJ =	Switched dc/open collector	Mechanical relay 5A, Form A
CK =	Switched dc/open collector	SSR Form A, 0.5A
EA =	Mechanical relay 5A, Form C	None
EH =	Mechanical relay 5A, Form C	NO-ARC 15A power control
EC =	Mechanical relay 5A, Form C	Switched dc
EJ =	Mechanical relay 5A, Form C	Mechanical relay 5A, Form A
EK =	Mechanical relay 5A, Form C	SSR Form A, 0.5A
FA =	Universal process	None
FC =	Universal process	Switched dc
FJ =	Universal process	Mechanical relay 5A, Form A
FK =	Universal process	SSR Form A, 0.5A
AK =	None	SSR Form A, 0.5A
KH =	SSR Form A, 0.5A	NO-ARC 15A power control
KK =	SSR Form A, 0.5A	SSR Form A, 0.5A

⑧ Communication Options or Additional Digital Outputs	
<b>Standard bus always included</b>	
A =	None
B =	Bluetooth**
E =	EIA 485 Modbus® RTU and Bluetooth**
F =	Modbus® RTU 232/485 and Bluetooth**
G =	EtherNet/IP™/ Modbus® TCP and Bluetooth**
H =	DeviceNet™ and Bluetooth**
J =	PROFIBUS DP and Bluetooth**
K =	SAE J1939 CAN bus and Bluetooth**
1 =	EIA 485 Modbus® RTU
2 =	EIA 232/485 Modbus® RTU
3 =	EtherNet/IP™/Modbus® TCP
5 =	DeviceNet™
6 =	PROFIBUS DP
7 =	SAE J1939 CAN bus
C =	6 digital I/O (not available on 1/16 DIN models)
D =	6 digital I/O and EIA 485 Modbus® RTU (not available on 1/16 DIN models)
M =	6 digital I/O and Bluetooth® (not available on 1/16 DIN models)*
N =	6 digital I/O and EIA 485 Modbus® RTU and Bluetooth® (not available on 1/16 DIN models)*

Watlow PM PLUS™

⑨ Auxiliary Control Functions	
A =	None
C =	2nd PID channel with universal input (not valid on 1/16 DIN models)
J =	2nd PID channel with thermistor input (not valid on 1/16 DIN models)
R =	Auxiliary 2nd input (universal input)
P =	Auxiliary 2nd input (thermistor input)
T =	Current transformer input (not valid Output 3 and 4 selections = FA, FC, FJ and FK)
L =	Integrated limit controller with universal input (only valid Output 3 and 4 selections = CJ, EJ and AJ)
M =	Integrated limit controller with thermistor input (only valid Output 3 and 4 selections = CJ, EJ and AJ)
<b>Note:</b> If communication options F, G, H, J, K or 2 thru 7 is ordered in previous digit, then Option A must be ordered here. All Models: Auxiliary input supports remote set point, backup sensor ratio, differential and wet-bulb/dry-bulb.	

⑩ ⑪ Output 3 and 4 Hardware Options		
	Output 3	Output 4
AA =	None	None
AJ =	None	Mechanical relay 5A, Form A
AK =	None	SSR Form A, 0.5A
CA =	Switched dc/open collector	None
CC =	Switched dc/open collector	Switched dc
CJ =	Switched dc/open collector	Mechanical relay 5A, Form A
CK =	Switched dc/open collector	SSR Form A, 0.5A
EA =	Mechanical relay 5A, Form C	None
EC =	Mechanical relay 5A, Form C	Switched dc
EJ =	Mechanical relay 5A, Form C	Mechanical relay 5A, Form A
EK =	Mechanical relay 5A, Form C	SSR Form A, 0.5A
FA =	Universal process	None
FC =	Universal process	Switched dc
FJ =	Universal process	Mechanical relay 5A, Form A
FK =	Universal process	SSR Form A, 0.5A
KK =	SSR Form A, 0.5A	SSR Form A, 0.5A

**Note:** If communication options F, G, H, J, K or 2 thru 7 is ordered in previous digit, then Option AA must be ordered here.

⑫ Model Selection	
P =	PM PLUS PID Version
V =	PM PLUS Enhanced firmware
X =	Not an order option. Appears when Express menu selected.

⑬ ⑭ Custom Options	
WP =	Watlow logo face plate
WN =	Face plate no logo/no name
AG =	Conformal coating
12 =	Class 1, Div. 2 (not available with integrated limit Option "L" or "M", or with Output types E, H or J)

\*Note: Bluetooth® not available in all countries, contact factory.



# PM PLUS PID Model Configuration Code



① ②	③	④	⑤	⑥ ⑦	⑧	⑨ ⑩ ⑪	⑫	⑬ ⑭
<b>PM</b>	<b>Package Size</b>	<b>Primary Functions</b>	<b>Power Supply Digital I/O</b>	<b>Output 1 and 2 Hardware Options</b>	<b>Comm. Options</b>	<b>Future Options</b>	<b>Model Selection</b>	<b>Custom Options</b>
						<b>A A A</b>		

③ Package Size	
6 =	1/16 DIN
8 =	1/8 DIN (Vertical)
9 =	1/8 DIN (Horizontal)

④ Primary Functions	
C =	PID controller with universal input
R =	PID controller with universal input and profiling ramp/soak
T =	PID controller with universal input and countdown timer
J =	PID controller with thermistor input
N =	PID controller with thermistor input and profiling ramp/soak

⑤ Power Supply, Digital Inputs/Outputs (I/O)	
1 =	100 to 240VAC
2 =	100 to 240VAC plus 2 digital I/O points
3 =	20 to 28VAC or 12 to 40VDC
4 =	20 to 28VAC or 12 to 40VDC, plus 2 digital I/O points

⑥ ⑦ Output 1 and 2 Hardware Options		
	Output 1	Output 2
CA =	Switched dc/open collector	None
CH =	Switched dc/open collector	NO-ARC 15A power control
CC =	Switched dc/open collector	Switched dc
CJ =	Switched dc/open collector	Mechanical relay 5A, Form A
CK =	Switched dc/open collector	SSR Form A, 0.5A
EA =	Mechanical relay 5A, Form C	None
EH =	Mechanical relay 5A, Form C	NO-ARC 15A power control
EC =	Mechanical relay 5A, Form C	Switched dc
EJ =	Mechanical relay 5A, Form C	Mechanical relay 5A, Form A
EK =	Mechanical relay 5A, Form C	SSR Form A, 0.5A
FA =	Universal process	None
FC =	Universal process	Switched dc
FJ =	Universal process	Mechanical relay 5A, Form A
FK =	Universal process	SSR Form A, 0.5A
AK =	None	SSR Form A, 0.5A
KH =	SSR Form A, 0.5A	NO-ARC 15A power control
KK =	SSR Form A, 0.5A	SSR Form A, 0.5A

⑧ Communication Options or Additional Digital Outputs	
<b>Standard bus always included</b>	
A =	None
B =	Bluetooth**
E =	EIA 485 Modbus® RTU and Bluetooth**
F =	Modbus® RTU 232/485 and Bluetooth**
G =	EtherNet/IP™/ Modbus® TCP and Bluetooth**
H =	DeviceNet™ and Bluetooth**
J =	PROFIBUS DP and Bluetooth**
K =	SAE J1939 CAN bus and Bluetooth**
1 =	EIA 485 Modbus® RTU
2 =	EIA 232/485 Modbus® RTU
3 =	EtherNet/IP™/Modbus® TCP
5 =	DeviceNet™
6 =	PROFIBUS DP
7 =	SAE J1939 CAN bus
C =	6 digital I/O (not available on 1/16 DIN models)
D =	6 digital I/O and EIA 485 Modbus® RTU (not available on 1/16 DIN models)
M =	6 digital I/O and Bluetooth® (not available on 1/16 DIN models)*
N =	6 digital I/O and EIA 485 Modbus® RTU and Bluetooth® (not available on 1/16 DIN models)*
*Note: Bluetooth® not available in all countries, contact factory.	

⑨ ⑩ ⑪ Future Options	
AAA =	Future Options

⑫ Model Selection	
P =	PM PLUS PID Version
V =	PM PLUS Enhanced firmware
X =	Not an order option. Appears when Express menu selected.

⑬ ⑭ Custom Options	
WP =	Watlow logo face plate
WN =	Face plate no logo/no name
AG =	Conformal coating
12 =	Class 1, Div. 2 (not available with mechanical relay Output types E, H or J)

---

# Specifications

## Controller

- User-selectable heat/cool, on-off, P, PI, PD, PID or alarm action
- Auto-tune with TRU-TUNE+ adaptive control algorithm
- Control sampling rates: input = 10Hz, outputs = 10Hz

## Profile Ramp/Soak

- 4 profiles, 40 total steps
- Accuracy (typical):  $\pm 30$  PPM at 77°F (25°C)  $+30/-100$  PPM at -4 to 149°F (-20 to 65°C)

## Isolated Serial Communications

- EIA 232/485, Modbus® RTU
- EtherNet/IP™/Modbus® TCP
- DeviceNet™
- PROFIBUS DP
- SAE J1939 CAN bus

## Wiring Termination—Touch-Safe Terminals

- Input, power and controller output terminals are touch safe, removable, 12 to 22 AWG
- Wire strip length 7.6 mm (0.30 in.)
- Torque 0.56 Nm (5.0 in-lb)

## Universal Input

- Thermocouple, grounded or ungrounded sensors greater than 20M $\Omega$  input impedance, 3 $\mu$ A open sensor detection, 2k $\Omega$  source resistance max.
- RTD 2- or 3-wire, platinum, 100 $\Omega$  and 1000 $\Omega$  @ 32°F (0°C) calibration to DIN curve (0.00385  $\Omega/\Omega/^\circ\text{C}$ )
- Process, 0-20mA @ 100 $\Omega$ , or 0-10VDC @ 20k $\Omega$ , 0-50mV at 20M $\Omega$ , 0-1000 $\Omega$  potentiometer; scalable; inverse scaling.

## Voltage Input Ranges

- Temperature stability  $\pm 100$  PPM/ $^\circ\text{C}$  maximum

## Milliamp Input Ranges

- Accuracy  $\pm 20 \pm 1$  LSD at standard conditions
- Temperature stability  $\pm 100$  PPM/ $^\circ\text{C}$  maximum

## Resolution Input Ranges

- 0 to 10V: 200 $\mu$ V nominal
- 0 to 20mA: 0.5mA nominal

## Sensor Accuracy Chart PM PLUS

Input Type	Max Error @ 25 Deg C	Accuracy Range Low	Accuracy Range High	Units
J	±1.75	0	750	Deg C
K	±2.45	-200	1250	Deg C
T	±1.55	-200	350	Deg C

Input Type	Max Error @ 25 Deg C	Accuracy Range Low	Accuracy Range High	Units
N	±2.25	0	1250	Deg C
E	±2.10	-200	900	Deg C
R	±3.9	0	1450	Deg C
S	±3.9	0	1450	Deg C
B	±2.66	870	1700	Deg C
C	±3.32	0	2315	Deg C
D	±3.32	0	2315	Deg C
F (PT111)	±2.34	0	1343	Deg C
RTD, 100 ohm	±2.00	-200	800	Deg C
RTD, 1000 ohm	±2.00	-200	800	Deg C
mV	±0.05	-50	50	mV
Volts	±0.01	0	10	Volts
mAdc	±0.02	0	20	mAmps DC
mAac	±5	0	50	mAmps AC

### Functional Operating Range

- Type J: -346 to 2192°F (-210 to 1200°C)
- Type K: -454 to 2500°F (-270 to 1371°C)
- Type T: -454 to 750°F (-270 to 400°C)
- Type E: -454 to 1832°F (-270 to 1000°C)
- Type N: -454 to 2372°F (-270 to 1300°C)
- Type C: 32 to 4200°F (0 to 2315°C)
- Type D: 32 to 4200°F (0 to 2315°C)
- Type F: 32 to 2449°F (0 to 1343°C)
- Type R: -58 to 3214°F (-50 to 1767°C)
- Type S: -58 to 3214°F (-50 to 1767°C)
- Type B: 32 to 3300°F (0 to 1816°C)
- RTD (DIN): -328 to 1472°F (-200 to 800°C)
- Process: -1999 to 9999 units

### Accuracy

- Calibration accuracy and sensor conformity: ±0.1% of span, ±1°C @ the calibrated ambient temperature and rated line voltage
- Types R, S, B; 0.2%
- Type T below -50°C; 0.2%
- Calibration ambient temperature @ 77°F ±5°F (25°C ±3°C)
- Accuracy span: 1000°F (540°C) min.
- Temperature stability: ±0.1°F/°F (±0.1°C/°C) rise in ambient max.

## Thermistor Input

Thermistor Input				
Input Type	Max Error @ 25 Deg C	Accuracy Range Low	Accuracy Range High	Units
Thermistor, 5K range	±5	0	5000	Ohms
Thermistor, 10K range	±10	0	10000	Ohms
Thermistor, 20K range	±20	0	20000	Ohms
Thermistor, 40K range	±40	0	40000	Ohms

- 0 to 40kΩ, 0 to 20kΩ, 0 to 10kΩ, 0 to 5kΩ
- 2.252kΩ and 10kΩ base at 25°C
- Linearization curves built in
- Third party Thermistor compatibility requirements

Base R @ 25C	Alpha Techniques	Beta THERM	YSI	Thermistor Curve
2.252K	Curve A	2.2K3A	004	A
10K	Curve A	10K3A	016	B
10K	Curve C	10K4A	006	C

## Current Transformer Input

- Accepts 0-50mA signal (user-programmable range)
- Displayed operating range and resolution can be scaled and are user-programmable

## 2 Digital I/O (ordered with power supply option)

- Update rate: 10Hz
- Input type: user-selectable, dc voltage or dry contact
- Output type: switched dc
- Output voltage: 24V
- Output 5: 24mA max. or drive one 3-pole DIN-A-MITE® Output 6: 10mA max, or drive one 1-pole DIN-A-MITE®

## Digital Inputs (DC Voltage)

- Max. input: 36V at 3mA
- Logic: min. high state 3V at 0.25mA, max. low state 2V

## Digital Inputs (Dry Contact)

- Logic: min. open resistance 10kΩ, max. closed resistance 50Ω
- Max. short circuit: 20mA

## Digital Input/Output Option - 6 DIO

- Digital input or output
- Update rate 10Hz
- Switched DC
- Internal supply limited to 400mA, maximum open circuit voltage of 25V, typical 8V at 80mA. Open Collector
- Max. switched voltage is 32V<sup>1</sup> (dc)
- Max. switched current per output is 1.5A
- Max. switched current for all 6 outputs is 8A

## Output Hardware

- Switched dc: 22 to 32VDC @ 30mA max. per single output and 40mA max. total per paired outputs (1 & 2, 3 & 4)
- Open collector: 30VDC max. @ 100mA max.
- SSR, Form A, 24 to 240VAC, 1A at 50°F (10°C) to 0.5A at 149°F (65°C) resistive load, 264VAC max., opto-isolated, without contact suppression, 120/240VAC @ 20VA pilot duty
- Electromechanical relay, Form A, 24 to 240VAC or 30VDC max., 5A resistive load, 100,000 cycles at rated load, 120/240 @ 125VA or 24VAC @ 25VA pilot duty
- Electromechanical relay, Form C, 24 to 240VAC or 30VDC max., 5A resistive load, 100,000 cycles at rated load, 120/240 @ 125VA or 24VAC @ 25VA pilot duty
- NO-ARC relay, Form A, 85 to 264VAC, 15A @ 122°F (50°C), resistive load, no VDC, 2,000,000 cycles at rated load
- Universal process output: range selectable; 0 to 10VDC +-15mv accuracy into a min. 1,000Ω load with 2.5mV nominal resolution; 0 to 20mA +-30uA accuracy into max. 800Ω load with 5μA nominal resolution; temperature stability 100ppm/°C

## Operator Interface

- LCD display
- Smooth touch keypad
- Programmable function key

## Line Voltage/Power

- High voltage option: 85 to 264VAC, 47 to 63Hz
- Low voltage option: 20 to 28VAC, +10/-15%; 50/60Hz, ±5% or 12 to 40VDC
- Max. power consumption: 10VA for PM6. 14VA for PM8/9.
- Data retention upon power failure via non-volatile memory

## Environment

- Operating temperature: 0 to 149°F (-18 to 65°C)
- Storage temperature: -40 to 185°F (-40 to 85°C)
- Relative humidity: 0 to 90% RH, non-condensing

## Agency Approvals

- cULus® UL®/EN/CSA C22.2 No 61010-1 Listed, File E185611
- CSA C22.2 No. 24, File 158031 (1/16 DIN sizes) all models are approved.
- IP 67, UL® Type 4X front seal indoor locations
- cULus® ANSI/ISA 12.12.01-2012, CSA-C22.2 No. 213-1987, Class 1, Div. 2, Groups A, B, C and D, Temperature Code T4A, File E184390 (optional)
- FM Class 3545 (limit controls)
- CE, RoHS by design, W.E.E.E.
- EtherNet/IP™ and DeviceNet™ ODVA Conformance Tested displays

## Weight

1/8 DIN (PM8 and 9)

- Controller: 284 g (10 oz.)

1/16 DIN (PM6)

- Controller: 186 g (6.6 oz.)



# Declaration of Conformity

## Series EZ-ZONE® PM



### WATLOW Electric Manufacturing Company

1241 Bundy Blvd.  
Winona, MN 55987 USA

Declares that the following product:☺

<u>Designation:</u>	<b>Series EZ-ZONE® PM (Panel Mount)</b>
<u>Model Numbers:</u>	<u>PM (3, 6, 8, 9 or 4)(Any Letter or number)(1, 2, 3 or 4)(A, C, E, F or K)(A, C, H, J or K) – (Any letter or number)(Any letter or number)(A, C, E, F or K)(A, C, H, J or K) (Any three letters or numbers)</u>
<u>Classification:</u>	<u>Temperature control, Installation Category II, Pollution degree 2, IP65</u>
<u>Rated Voltage and Frequency:</u>	<u>100 to 240 V~ (ac 50/60 Hz) or 15 to 36 V==dc/ 24 V~ac 50/60 Hz</u>
<u>Rated Power Consumption:</u>	<u>10 VA maximum PM3, PM6 Models. 14 VA maximum PM8, PM9, PM4 Models</u>

Meets the essential requirements of the following European Union Directives by using the relevant standards show below to indicate compliance.

### **2014/30/EU Electromagnetic Compatibility Directive**

<b>EN 61326-1:2013</b>	<b>Electrical equipment for measurement, control and laboratory use – EMC requirements (Industrial Immunity, Class A Emissions).</b>
IEC 61000-4-2:2008	Electrostatic discharge immunity
IEC 61000-4-3:2007 +A1/2008, A2/2010	Radiated, radio-frequency electromagnetic field immunity 10V/M 80–1000 MHz, 3 V/M 1.4–2.7 GHz
IEC 61000-4-4:2012	Electrical fast-transient / burst immunity
IEC 61000-4-5:2014 +A1/2017	Surge immunity
IEC 61000-4-6:2013 + Corrigendum 2015	Immunity to conducted disturbances induced by radio-frequency fields
IEC 61000-4-11:2020	Voltage dips, short interruptions and voltage variations immunity
IEC 61000-3-2:2014	Limits for harmonic current emissions for equipment ≤ 16 Amps per phase
EN 61000-3-3 <sup>1</sup> :2013 + A1/2017	Voltage fluctuations and flicker ≤ 16 Amps per phase
SEMI F47-0812	Specification for semiconductor sag immunity Figure R1-1

<sup>1</sup>For mechanical relay loads, cycle time may need to be extended up to 160 seconds to meet flicker requirements depending on load switched and source impedance.

Use in commercial or residential applications may require additional filtering to pass Class B emissions levels, system testing should be done to confirm.

### **2014/35/EU Low-Voltage Directive**

<b>EN 61010-1:2010<sup>2</sup> +A1:2019</b>	<b>Safety Requirements of electrical equipment for measurement, control and laboratory use. Part 1: General requirements</b>
---	--

<sup>2</sup> Compliance with 3rd Edition requirements with use of external surge suppressor installed on 230 Vac~ power line units. Recommend minimum 1000 V peak to maximum 2000 V peak, 70 joules or better part be used.

### **Compliant with 2015/863/EU “RoHS3” Directive**

**Per 2012/19/EU W.E.E.E Directive  Please Recycle Properly.**

**Models PM(4, 8 or 9)E contain a type BR1225 coin cell battery which shall be recycled at end of life per 2006/66/EC Battery Directive as amended by 2013/56/EU Directive.**

## Models PM6XXXX – (B, E, F, G, H, J, K)XXXXXX

where (X = any letter or number allowed above)

Include *Bluetooth*® wireless technology and have been reviewed to the following additional requirements.

### 2014/53/EU Radio Equipment Directive (RED)

EN 61010-1:2010	Safety Requirements of electrical equipment for measurement, control and laboratory use. Part 1: General requirements Covering the essential requirements of article 3.1(a) or Directive 2014/53/EU
EN 61326-1:2013 +A1, 2019	Electrical equipment for measurement, control and laboratory use – EMC requirements (Industrial Immunity, Class A Emissions). <i>CAUTION: This equipment not intended for use in residential environments and may not provide adequate protection to radio reception in such environments.</i>
EN 301 489-1 V2.1.1	ElectroMagnetic Compatibility (EMC) standard for radio equipment and services; Part 1: Common technical requirements; Harmonized Standard covering the essential requirements of article 3.1(b) of Directive 2014/53/EU and the essential requirements of article 6 of Directive 2014/30/EU
EN 301 489-17 V3.1.1	ElectroMagnetic Compatibility (EMC) standard for radio equipment and services; Part 17: Specific conditions for Broadband Data Transmission Systems; Harmonized Standard covering the essential requirements of article 3.1(b) of Directive 2014/53/EU
EN 300 328 V1.9.1	Electromagnetic compatibility and Radio spectrum Matters (ERM); Wideband transmission systems; Data transmission equipment operating in the 2,4 GHz ISM band and using wide band modulation techniques; Harmonized EN covering the essential requirements of article 3.2 of the R&TTE Directive NVLAP Test Report 10928545H-A
EN 300 328 V2.1.1	Additional Receiver blocking test for to cover requirements for 2014/53/EU. NVLAP Test Report 11649468H-E

Contains Module FCC ID: VPYLBZY Part 15C 2.

Contains Module IC: 772C-LBZY RSS 210

- Japanese Radio Law (日本電波法)

Type certification (工事設計認証)



R001-P00500

Output Power: Frequency Range 2402.0 - 2480.0 Output Power 0.001 Watts  
Antenna gain: -0.6 dBi PCB antenna

Doug Kuchta  
Name of Authorized Representative

Winona, Minnesota, USA  
Place of Issue

Director of Operations  
Title of Authorized Representative

October 2021  
Date of Issue

Signature of Authorized Representative

CE DOC EZ-ZONE PM-10-21

