

EZ-ZONE® RM Limit Module

User's Guide

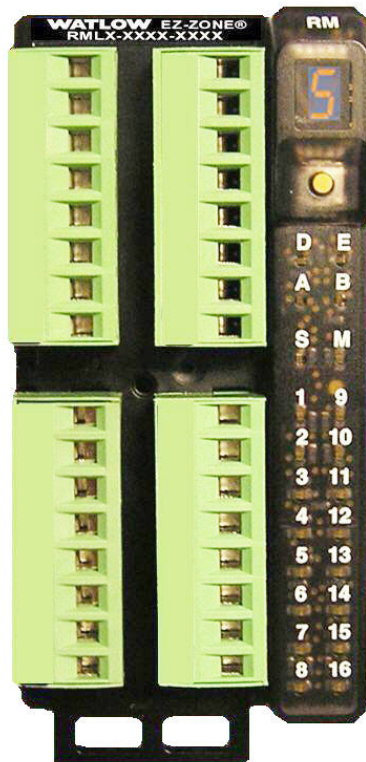

RM Limit Module



1241 Bundy Boulevard., Winona, Minnesota USA 55987
Phone: +1 (507) 454-5300, Fax: +1 (507) 452-4507 <http://www.watlow.com>



Safety Information

We use note, caution and warning symbols throughout this book to draw your attention to important operational and safety information.

A “NOTE” marks a short message to alert you to an important detail.

A “CAUTION” safety alert appears with information that is important for protecting your equipment and performance. Be especially careful to read and follow all cautions that apply to your application.

A “WARNING” safety alert appears with information that is important for protecting you, others and equipment from damage. Pay very close attention to all warnings that apply to your application.

The safety alert symbol,  (an exclamation point in a triangle) precedes a general CAUTION or WARNING statement.

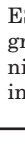
The electrical hazard symbol,  (a lightning bolt in a triangle) precedes an electric shock hazard CAUTION or WARNING safety statement. Further explanations follow:

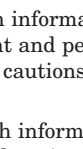
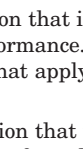
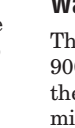
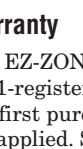
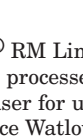
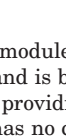
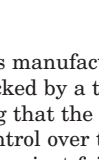
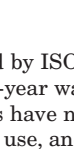
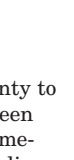
Symbol	Explanation
	CAUTION – Warning or Hazard that needs further explanation than label on unit can provide. Consult User's Guide for further information.
	ESD Sensitive product, use proper grounding and handling techniques when installing or servicing product.
	Unit protected by double/reinforced insulation for shock hazard prevention.
	Do not throw in trash, use proper recycling techniques or consult manufacturer for proper disposal.
	Enclosure made of Polycarbonate material. Use proper recycling techniques or consult manufacturer for proper disposal.
	Unit can be powered with either alternating current (ac) voltage or direct current (dc) voltage.
	Unit is a Listed device per Underwriters Laboratories®. It has been evaluated to United States and Canadian requirements for Process Control Equipment. UL 61010 and CSA C22.2 No. 61010. File E185611 QUYY, QUYY7. See: www.ul.com
	Unit is compliant with European Union directives. See Declaration of Conformity for further details on Directives and Standards used for Compliance.
	Unit has been reviewed and approved by Factory Mutual as a Temperature Limit Device per FM Class 3545 standard. See: www.fmglobal.com



Unit has been reviewed and approved by CSA International for use as Temperature Indicating-Regulating Equipment per CSA C22.2 No. 24. See: www.csa-international.org

Warranty

The EZ-ZONE® RM Limit module is manufactured by ISO 9001-registered processes and is backed by a three-year warranty to the first purchaser for use, providing that the units have not been misapplied. Since Watlow has no control over their use, and sometimes misuse, we cannot guarantee against failure. Watlows' obligations hereunder, at Watlows' option, are limited to replacement, repair or refund of purchase price, and parts which upon examination prove to be defective within the warranty period specified. This warranty does not apply to damage resulting from transportation, alteration, misuse or abuse. The purchaser must use Watlow parts to maintain all listed ratings.

Technical Assistance

If you encounter a problem with your Watlow controller, review your configuration information to verify that your selections are consistent with your application: inputs, outputs, alarms, limits, etc. If the problem persists, you can get technical assistance from your local Watlow representative (see back cover), by e-mailing your questions to wintechsupport@watlow.com or by dialing +1 (507) 494-5656 between 7 a.m. and 5 p.m., Central Standard Time (CST). Ask for an Applications Engineer. Please have the following information available when calling:

- Complete model number
- All configuration information
- User's Guide
- Factory Page

Return Material Authorization (RMA)

1. Call Watlow Customer Service, (507) 454-5300, for a Return Material Authorization (RMA) number before returning any item for repair. If you do not know why the product failed, contact an Application Engineer or Product Manager. All RMA's require:
 - Ship-to address
 - Bill-to address
 - Contact name
 - Phone number
 - Method of return shipment
 - Your P.O. number
 - Detailed description of the problem
 - Any special instructions
 - Name and phone number of person returning the product.
2. Prior approval and an Return Merchandise Authorization number from the Customer Service Department is required when returning any product for credit, repair or evaluation. Make sure the Return Merchandise Authorization number is on the outside of the carton and on all paperwork returned. Ship on a Freight Prepaid basis.
3. After we receive your return, we will examine it and try to verify the reason for returning it.
4. In cases of manufacturing defect, we will enter a repair order, replacement order or issue credit for material returned. In cases of customer misuse, we will provide repair costs and request a purchase order to proceed with the repair work.

5. To return products that are not defective, goods must be in new condition, in the original boxes and they must be returned within 120 days of receipt. A 20 percent restocking charge is applied for all returned stock controls and accessories.
6. If the unit cannot be repaired, you will receive a letter of explanation and be given the option to have the unit returned to you at your expense or to have us scrap the unit.
7. Watlow reserves the right to charge for no trouble found (NTF) returns.

This EZ-ZONE® RM Limit User's Guide is copyrighted by Watlow Electric, Inc., © December 2013 with all rights reserved.

EZ-ZONE RM is covered by U.S. Patent No. 6,005,577 and Patents Pending



Table of Contents

- Chapter 1: Overview 3**
 - Standard Features and Benefits 4
 - A Conceptual View of the RML 5
 - Getting Started Quickly 8
 - Dimensions 11
- Chapter 2: Install and Wire 11**
 - Power Supplies 13
 - RML Installation and Removal on a DIN Rail 14
 - Wiring 16
 - Conventions Used in the Menu Pages 29
- Chapter 3: Operations Pages 31**
 - Analog Input Menu 32
 - Digital Input/Output Menu 32
 - Action Menu 33
 - Limit Menu 33
 - Alarm Menu 34
 - Linearization Menu 35
 - Compare Menu 36
 - Timer Menu 36
 - Counter Menu 37
 - Logic Menu 38
 - Math Menu 39
- Chapter 4: Setup Pages 41**
 - Analog Input Menu 43
 - Digital Input/Output Menu 45
 - Action Menu 46
 - Limit Menu 47
 - Output Menu 48
 - Alarm Menu 49
 - Linearization Menu 51
 - Compare Menu 53
 - Timer Menu 55
 - Counter Menu 57
 - Logic Menu 59



Table of Contents (cont.)

- Math Menu 67
- Variable Menu 70
- Global Menu 71
- Communications Menu 71
- Chapter 5: Factory Pages 73**
- Custom Setup Menu 74
- Security Setting Menu 74
- Security Setting Menu 75
- Diagnostics Menu 76
- Calibration Menu 76
- Chapter 6: Features 78**
- Saving and Restoring User Settings 79
- Module Limit 79
- Inputs 79
- Alarms 81
- Using Lockout to Hide Pages and Menus 82
- Using Password Security 83
- Modbus - Using Programmable Memory Blocks 84
- Software Configuration 85
- Function Block Descriptions 88
- Chapter 7: Appendix 111**
- Modbus - Programmable Memory Blocks 111
- Troubleshooting Alarms, Errors and Module Issues 115
- RML Specifications 117
- EZ-ZONE Rail-Mount Limit Module Ordering Information 119
- Index 120
- How to Reach Us 124

1

Chapter 1: Overview

Available EZ-ZONE RM System Literature and Resources

Document Title and Part Number	Description
EZ-ZONE Rail Mount Access (RMA) User's Guide, part number: 0600-0072-0000	Describes how to connect the RM system into an industrial network, how to use data logging, module backup and the real-time clock.
EZ-ZONE Rail Mount Controller (RMC) User's Guide, part number: 0600-0070-0000	The RMC module is an advanced integrated controller capable of PID and limit control. This document describes how to configure and program all loops of control and communications.
EZ-ZONE Rail Mount Scanner (RMS) User's Guide, part number: 0600-0071-0000	This module adds monitoring points to the RM system. This document describes common usage and the various types of I/O available.
EZ-ZONE Rail Mount Expansion (RME) User's Guide, part number: 0600-0073-0000	When additional I/O is needed the Expansion module fills the gap. This document describes common usage and the various types of I/O available.
EZ-ZONE Rail Mount Limit (RMH) User's Guide, part number: 0600-0074-0000	This module extends the density of the standard RM modules (number of control loops and I/O points). The User Guide describes common usage, communications and the number I/O points available.
EZ-ZONE Remote User Interface (RUI) User's Guide, part number: 0600-0060-0000	The RUI provides a visual LED display to the RM configuration and setup menus. This document illustrates and describes connections and also describes the Home Page for each RM module as viewed from the RUI.
EZ-ZONE RM Specification Sheet, part number: WIN-EZRM-1113	Describes RM hardware options, features, benefits and technical specifications.
Watlow Support Tools DVD, part number: 0601-0001-0000	Contains all related user documents, tutorial videos, application notes, utility tools, etc...

The DVD described above ships with the product and as stated contains all of the literature above as well as much more. If the DVD is not available one can be acquired by contacting Watlow Customer Service at 1-507-454-5300.

As an alternative to the DVD, all of the user documentation described above can also be found on the Watlow website. Click on the following link to find your document of choice: <http://www.watlow.com/literature/index.cfm>. Once there, simply type in the desired part number (or name) into the search box and download free copies. Printed versions of all user documents can also be purchased here as well.

Your Comments are Appreciated

In an effort to continually improve our technical literature and ensure that we are providing information that is useful to you, we would very much appreciate your comments and suggestions. Please send any comments you may have to the following e-mail address: TechlitComments@watlow.com

Introduction

The EZ-ZONE® Rail Mount Limit Module (RML) is used in thermal applications to limit inadvertent over-temperature conditions. The RML controller provides multi-loop (12 loops maximum) safety assurance against instances where over or under temperature runaway conditions could occur from a shorted input sensor or an output device that could fail in a closed position. The RML is recommended for any application where thermal runaway could result in large product scrap costs, affect operator safety, cause damage to equipment, or create a fire hazard.

It just got a whole lot easier to solve the thermal requirements of your system. The EZ-ZONE RML module is provided in a space-saving, rail-mount package and is highly scalable where you only pay for what you need. Ordering options allow for 1 to 12 loops and for those applications that require the ability to configure/monitor over a network the Modbus RTU communication protocol is an option. Other communications protocols are also available (e.g., EtherNet/IP, DeviceNet, Modbus TCP and Profibus DP) when used in conjunction with a Rail Mount Access (RMA) module or when using a Remote User Interface/ Gateway (RUI/GTW).

Programmable Menu System

- Reduces set up time and increases operator efficiency

Full-featured Alarms

- Improves operator recognition of system faults
- Control of auxiliary devices

Standard Features and Benefits

EZ-ZONE configuration communications and software

- Saves time and improves the reliability of controller set up

FM Approved Over-under Limit with Auxiliary Outputs

- Increases user and equipment safety for over-under temperature conditions

Parameter Save & Restore Memory

- Reduces service calls and down time

Agency approvals: UL Listed, CSA, CE, RoHS, W.E.E.E. FM

- Assures prompt product acceptance
- Reduces end product documentation costs
- FM approval on Limit Models
- Semi F47-0200

Three-year warranty

- Demonstrates Watlow's reliability and product support

Touch-safe Package

- IP2X increased safety for installers and operators

Removable cage clamp wiring connectors

- Reliable wiring, reduced service calls
- Simplified installation

A Conceptual View of the RML

The flexibility of the RML's software and hardware allows for variation in configurations. Acquiring a better understanding of its functionality and capabilities while at the same time planning out how the controller can be used will deliver maximum effectiveness in your application.

It is useful to think of the controller in three parts: inputs, procedures and outputs. Information flows from an input to a procedure to an output when the controller is properly configured. An RML controller can carry out several procedures at the same time, e.g., monitoring for several different alarm situations, monitoring and acting upon digital inputs and driving output devices such as audible alarms, lights and contactors. Each process needs to be thought out carefully and the controller's inputs, procedures and outputs set up properly.

Inputs

The inputs provide the information that any given programmed procedure can act upon. Simply stated, this information may come from an operator pushing a button or from a sensor monitoring the temperature of a part being heated or cooled.

Each analog input typically uses a thermocouple, RTD or thermistor to read the process temperature. It can also read volts, current or resistance, allowing it to use various devices to read humidity, air pressure, operator inputs and others values. The settings in the Analog Input Menu (Setup Page) for each analog input must be configured to match the device connected to that input.

Each digital input reads whether a device is active or inactive. An RML equipped with digital input/output hardware includes two sets of terminals where each of which can be used as either an input or an output. Each pair of terminals must be configured to function as either an input or output with the direction parameter in the Digital Input/Output Menu (Setup Page).

Functions

Functions use input signals to calculate a value. A function may be as simple as reading a digital input to set a state to true or false, or reading a temperature to set an alarm state to on or off. Alternatively, if a failure with the primary sensing device should occur the limit could trip a contactor removing power from the heating element to avoid damaging the load.

To set up a function, it's important to tell it what source, or instance, to use. For example, if the control is equipped with digital inputs they can be configured to reset an individual alarm or all alarms. If configured as such, the next step would be to define which of the available digital inputs would be tied to the alarm reset function. The RML module can be equipped with up to 7 digital inputs, instance 1 - 6 and or 9. Once the specific input has been selected

simply assign the alarm reset function to it (Setup Page, DIO Menu). The last step would be to define the alarm instance that should be reset. If zero is entered for the alarm instance when the digital input selected above is enabled, all latched alarms without a currently existing alarm condition will be reset. If a specific alarm instance (1 -16) is selected it will be that instance alone that will be reset.

Note:

Alarms will reset automatically when the condition that caused the alarm goes back to a non-alarm state if the alarm latching prompt is set to non-latching (Setup Page, ALM Menu).

Keep in mind that a function is a user-programmed internal process that does not execute any action outside of the controller. To have any effect outside of the controller, an output must be configured to respond to a function.

Outputs

Outputs can perform various functions or actions in response to information provided by a function, such as removal of the control voltage to a contactor; turning a light on or off; unlocking a door; or turning on an audible alarm.

Assign an output to a function in the Output Menu or Digital Input/Output Menu. Then select which instance of that function will drive the selected output. For example, in using a Limit Control an output can be configured to respond to an alarm, i.g., (instance 15) or to a limit condition.

You can assign more than one output to respond to a single instance of a function. For example, alarm 2 could be used to trigger a light connected to output 1 and a siren connected to digital output 5.

Input Events and Output Events

Input events are internal states that are set by the digital inputs. Digital Input 1 provides the state of input event 1, and Digital Input 2 provides the state of input event 2. The setting of Digital Input Function (Setup Page, Digital Input/Output Menu) does not change the relationship between the input and the event. An input will still control the input event state, even if Digital Input Function is set to None.

Actions

Based on a given input (Digital I/O, Event output, Logic function, etc..) the Action function can cause other functions to occur. To name a few, set alarms to off, silencing alarms and reset a tripped limit condition. Energise

Module Limit

This function allows the user to setup a single output to reflect an energized (safe) or deenergized (tripped) state for the module. If any configured limit is tripped (process value exceeds set point or limit in-

put has malfunctioned), the output assigned to serve as this function will come on. By default (factory settings), output 8 is assigned this function where any output of choice can be configured as such.

A Conceptual View of RM Hardware Configurations

Due to the scalability and flexibility in the RM system a user has several options available in the way that the hardware can be connected. Listed below are a few examples.

RML Connected to a Remote User Interface (RUI) and a Personal Computer (PC)

In this configuration the RUI and PC are connected to the RML module via Watlow's Standard Bus where both will be able to talk directly to the RML module.

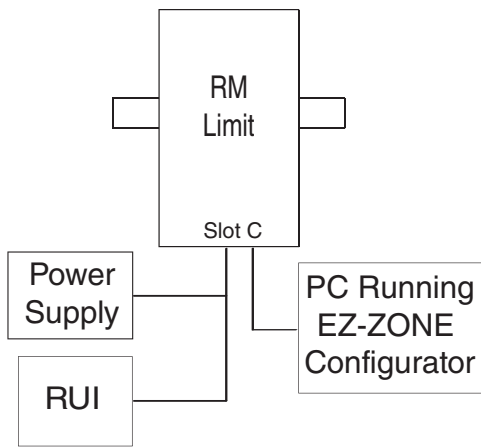

In the graphic above the PC running EZ-ZONE Configurator software and or the RUI can be used to configure and then monitor the RML and other modules connected to it.

RML Module Connected to a Programmable Logic Controller (PLC) on a DIN Rail

In this configuration the PLC can be connected to the RML module using the Modbus RTU protocol:

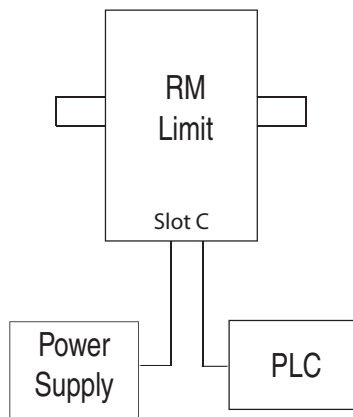

In this example, the RML module and the PLC must be equipped with the Modbus RTU protocol.

Note:

If it is intended to use an RUI or a PC using EZ-ZONE Configurator software it will be necessary to switch the protocol on the RML to Watlow's Standard Bus to successfully communicate; disconnect all Modbus devices from the network. Once done using the RUI or EZ-ZONE Configurator software, switch the protocol back to Modbus RTU and reconnect all Modbus devices to re-establish communications over Modbus.

RML Module Connected to an Operator Interface Terminal (OIT) through an RMA

In this configuration the RML can be connected to the OIT through the RMA running any of a number of available protocols. The RMA and the OIT must be using the same protocol while the communications from RMA to the RML module is accomplished over the backplane using Watlow's Standard Bus protocol. Available protocols in the RMA follow:

1. EtherNet/IP and or Modbus TCP
2. DeviceNet
3. Modbus RTU
4. Profibus DP

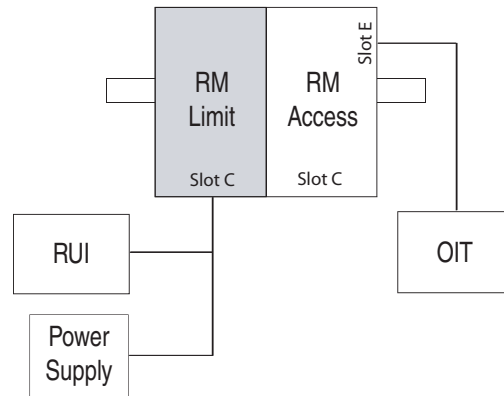

Notice that in the example above that there is an *optional* RUI connected to the RML along with the OIT. OITs' are not generally used to configure a control but are used more for run-time information. As an alternative for configuration the RUI could be used to configure and monitor in a remote location.

One advantage in using an RMA module when communicating on a network is that protocol switching is not needed on the RML module if using an RUI or EZ-ZONE Configurator software. The protocol of choice used with the RMA can run simultaneously with the Standard Bus protocol.

RML Connected to a Split Rail with OIT

In this configuration both the inter-module bus (backplane communications) and Standard Bus are connected between rails to allow for remote capabilities. It is recommended that the split rail connection not exceed 100 feet. In this configuration the OIT can

communicate with all modules (maximum 16 modules any combination with one Access module).

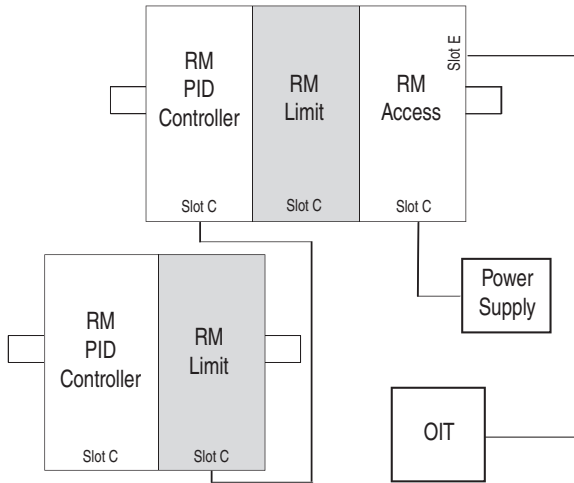

Module Orientation

The picture that follows represents one of several different RM modules. All of them will have four slots on the face (slot A, B, D, and E) and one on the bottom (slot C) not shown. All of these slots are not always used on all modules. On the face of the module there is a button (yellow circle) under the Zone address (5). When pushed and held it has the following functions:

1. For any module, push and hold for ~ 2 seconds to change the Zone address
2. When a module is equipped with the Modbus protocol (RMxxxxxxxx1xx) pushing and holding this button for ~ 6 seconds the LED display will return **P** for protocol. Releasing the button and then pushing it again (within 6 seconds) the display will toggle between **M** (Modbus) and **S** (Standard Bus). Valid addresses for Modbus and Standard bus range from 1 -16 (**1** - **9**, **R** is 10, **b** is 11, **C** is 12, **d** is 13, **E** is 14, **F** is 15, and **H** is 16). The RMA (Access) module is shipped at address **J** or 17 and is the only module that can have its address set above 16.

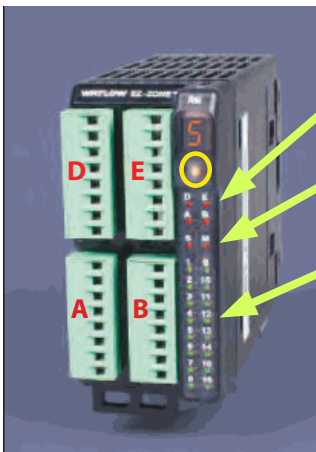

Module Status (Slot A, B, D, or E)

Protocol (Standard Bus - red or Modbus - green)

Module outputs 1 through 10, all may or may not be used depending on module type



Getting Started Quickly



Consider taking the following steps to quickly commission your control:

- **Wire** and connect the power source to the control
- Wire and connect input and output devices to the control
- Power up the control and navigate to the Setup Page to configure inputs, outputs, alarms, etc...
- Once the control is setup, navigate to the Operations Page to set limit and alarm set points.

The default RML loop configuration out of the box is shown below:

- Analog Input functions are set to thermocouple, type J (to change go to the Setup Page)
- Limit sides set to both, high and low (to change go to the Setup Page)
- Output 8 set to module limit (to change go to the Setup Page)
- Limit low set point set to 0°F (to change go to the Operations Page)
- Limit high set point set to 0°F (to change go to the Operations Page)
- Limit is deenergized, also referred to as a tripped state

Once the control has been wired and setup, power up the control and change the appropriate limit set points (high and or low) to the desired value (on the RUI push the up  and or down  arrow key). Once the set point is set to the desired level, reset the limit by using one of the four methods described below:

- 1 - Use a digital input, function key or a variable to reset the limit
- 2 - Using an RUI, push the green Advance Key  and then the Infinity Key 
- 3 - Using Modbus RTU send the enumerated value of zero (0) to register 1490, loop 1 (see the Operations Page, Limit Menu)
- 4 - Cycle power on the control

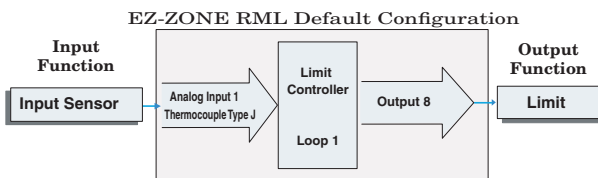











Note:

Output 8 will default as a module limit. As a module limit, the LED will be illuminated when one or more limit loops is in a tripped (deenergized) state. When the module is in a safe state the output LED will be off.

The RML controller has a page and menu structure that is listed below along with a brief description of its purpose. The menu structure can be easily seen and navigated using [EZ-ZONE Configurator software](#) or the Remote User Interface (RUI).

Note:

The menu navigation as described below applies when the RML is connected to the RUI which is optional equipment.

<p>Setup Page</p> <p>Using the RUI, push and hold the up and down keys ( ) for 6 seconds to enter. (See the Setup Page for further information)</p>	<p>A user would want to setup their control prior to operation. As an example, define the limit sides (high and or low), change the input type, or set the output function.</p>
<p>Operations Page</p> <p>Using the RUI push and hold the up and down keys ( ) for 3 seconds to enter. (See the Operations Page for further information)</p>	<p>After setting up the control to reflect your equipment, the Operations Page would be used to monitor or change runtime settings. As an example, the user may want to change the limit high/low set point or perhaps change an alarm set point.</p>
<p>Factory Page</p> <p>Using the RUI push and hold the Infinity and the green Advance keys ( ) for 6 seconds to enter. (See the Factory Page for further information)</p>	<p>For the most part the Factory Page has no bearing on the control when running. A user may want to enable password protection, view the control part number or perhaps create a custom Home Page.</p>
<p>Home Page</p> <p>When using the RUI the control is at the Home Page when initially powered up.</p> <p>Note: The Home Page is visible only when using the RUI.</p>	<p>Pushing the green Advance Key  and then the Infinity Key  will reset a limit if tripped (if trip condition no longer exists); or, by pushing the green Advance Key  the limit high and or low set points could be displayed and changed using the up and down keys ( .</p>

EZ-ZONE RML-Limit Module - System Diagram
12 Limit Loops-Slots A, B, D
4-Form A Mechanical Relay Outputs Slot E

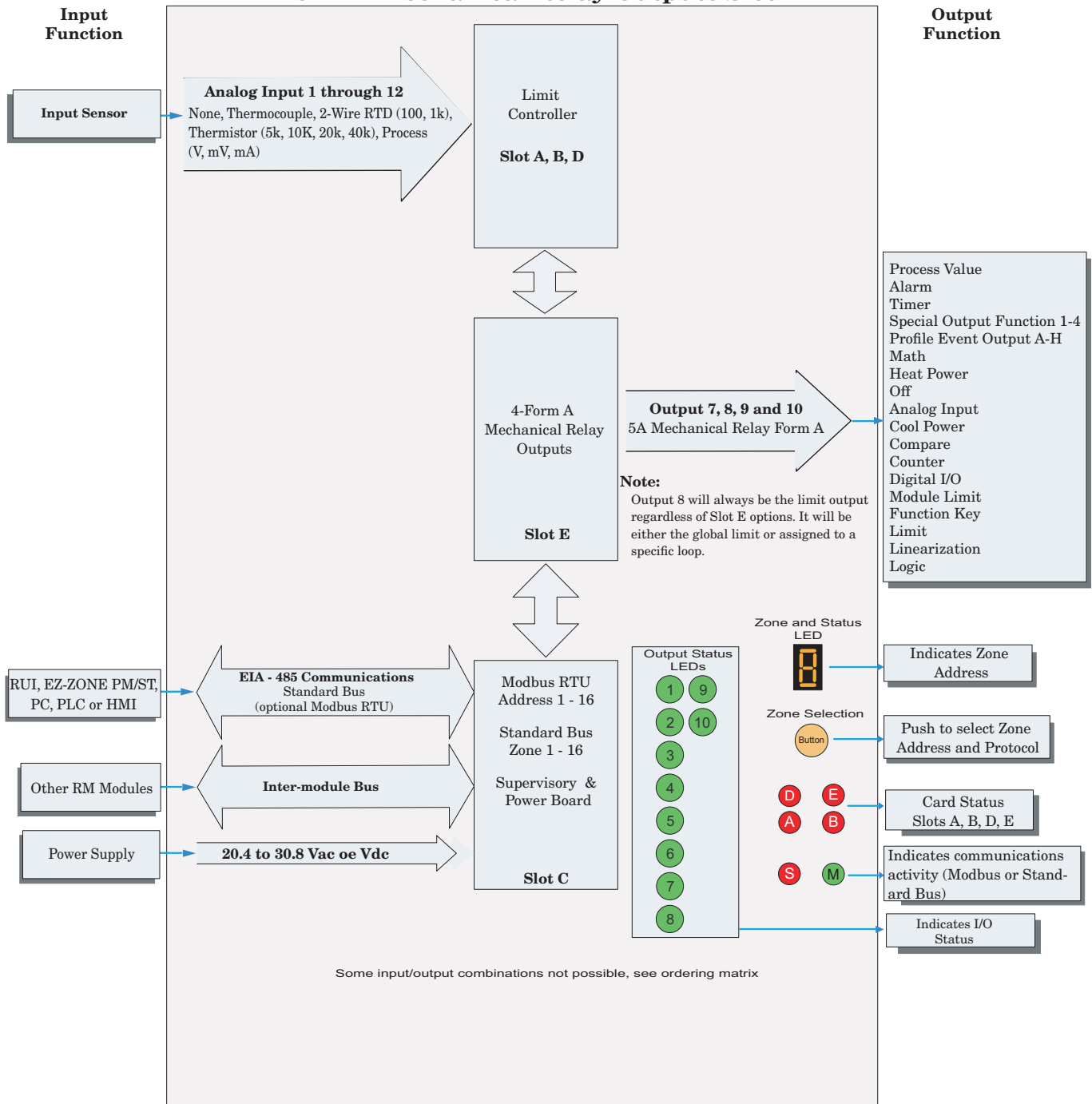

EZ-ZONE RML-Limit Module - System Diagram
6-Digital Inputs or Output Card in Slot D
1-Digital Input/2 Mechanical Relay Outputs Slot E

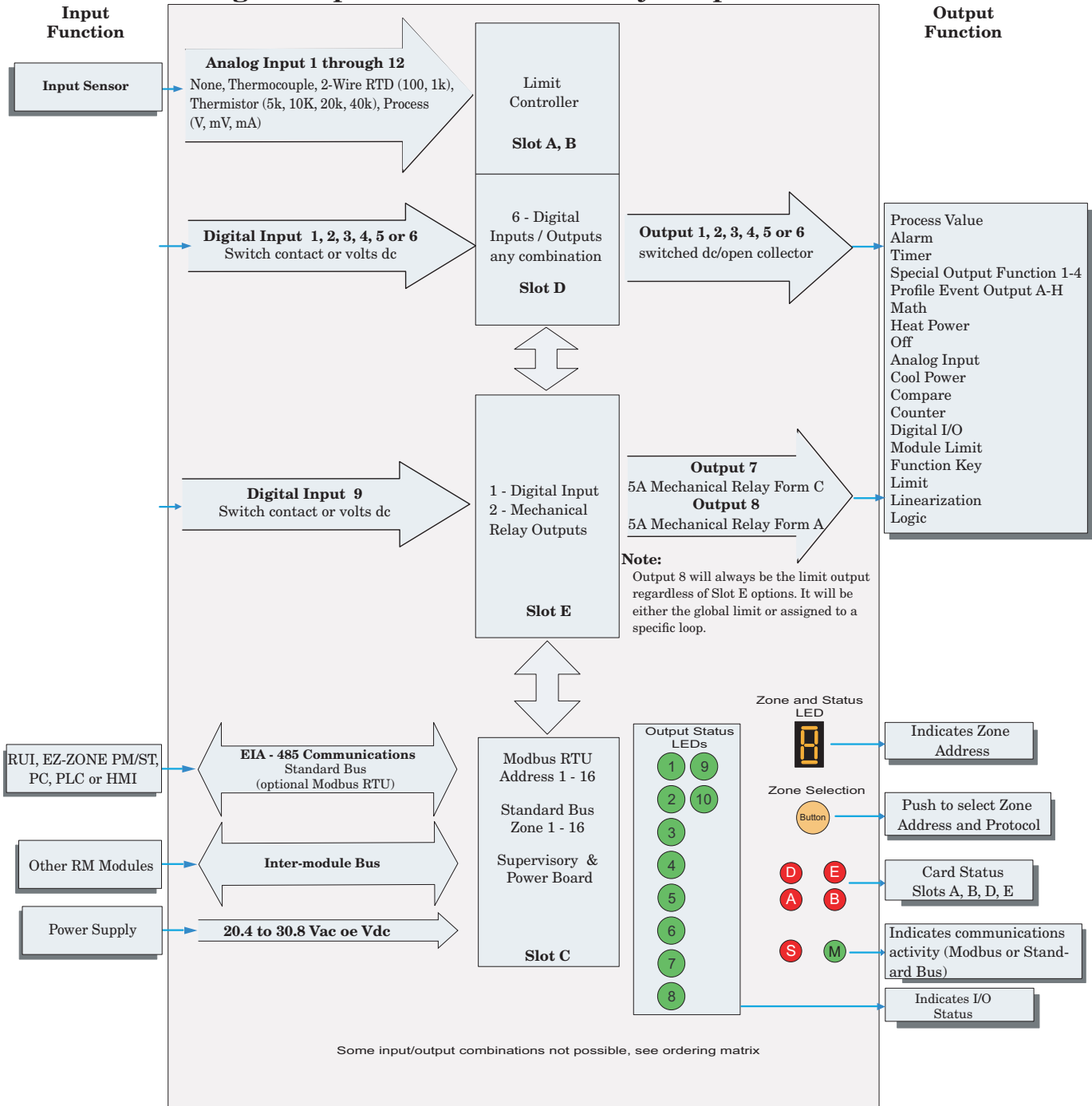

2

Chapter 2: Install and Wire

Dimensions

As can be seen below the dimensions of the RM system will change slightly based on the type of connector used.

Module Removal Clearance

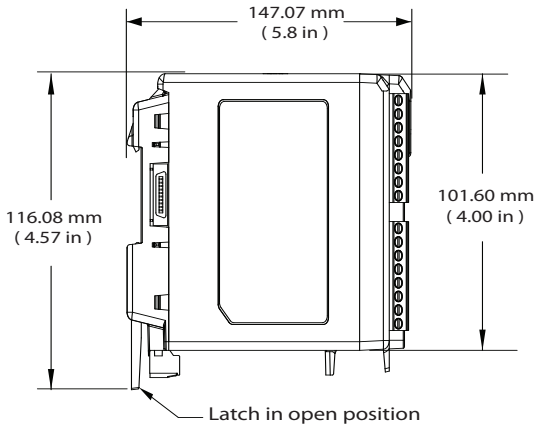

Standard Connectors

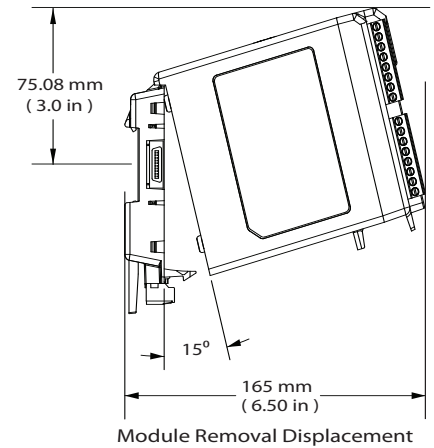
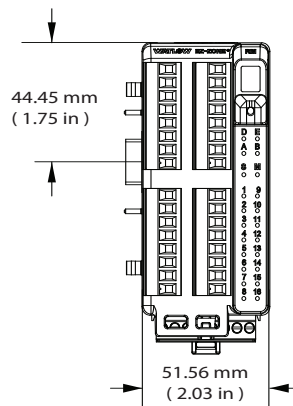

Module Removal Clearance

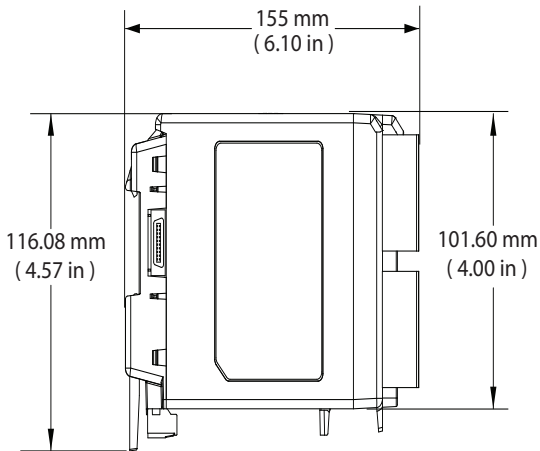

Straight Connectors

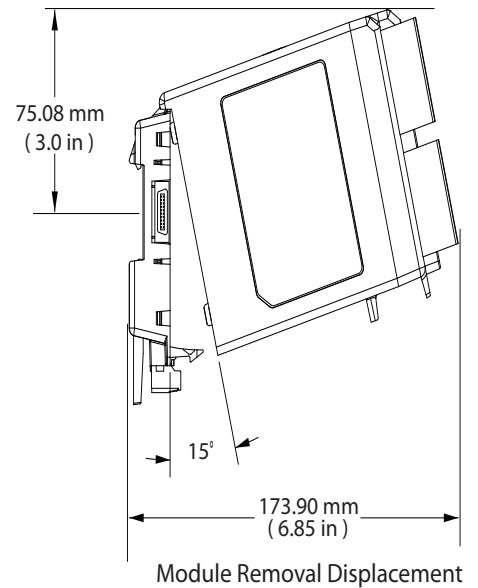
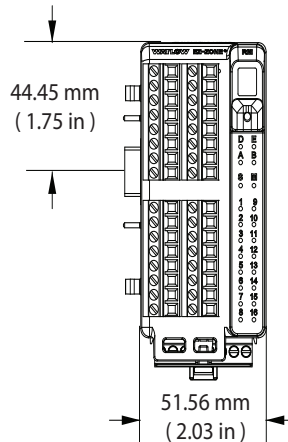

Chassis Mount Front View (Module Removed) - Screw Connection Pattern

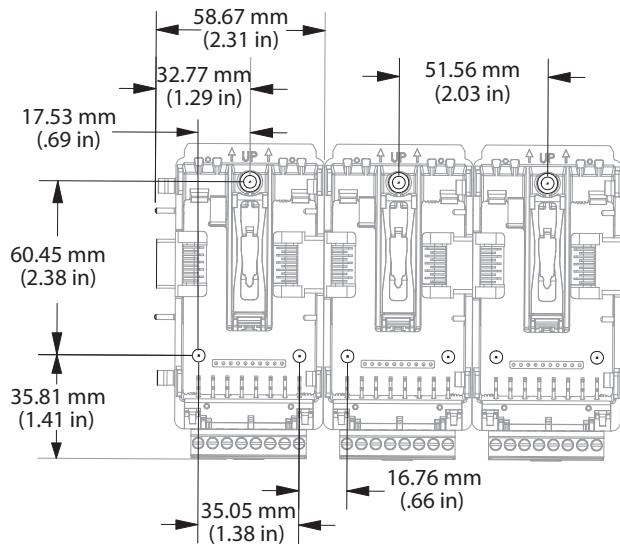

The view above is representative of the modular backplane without the module.

Recommended chassis mount hardware:

1. #8 screw, 3/4" long
2. Torque to 10 -15 in-lb
3. No washers of any kind

Power Supplies

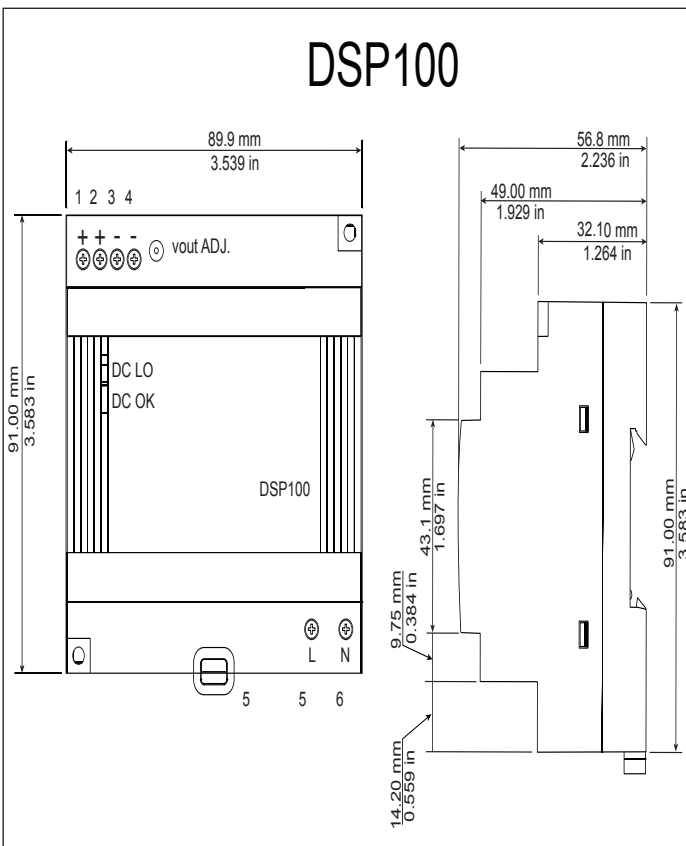
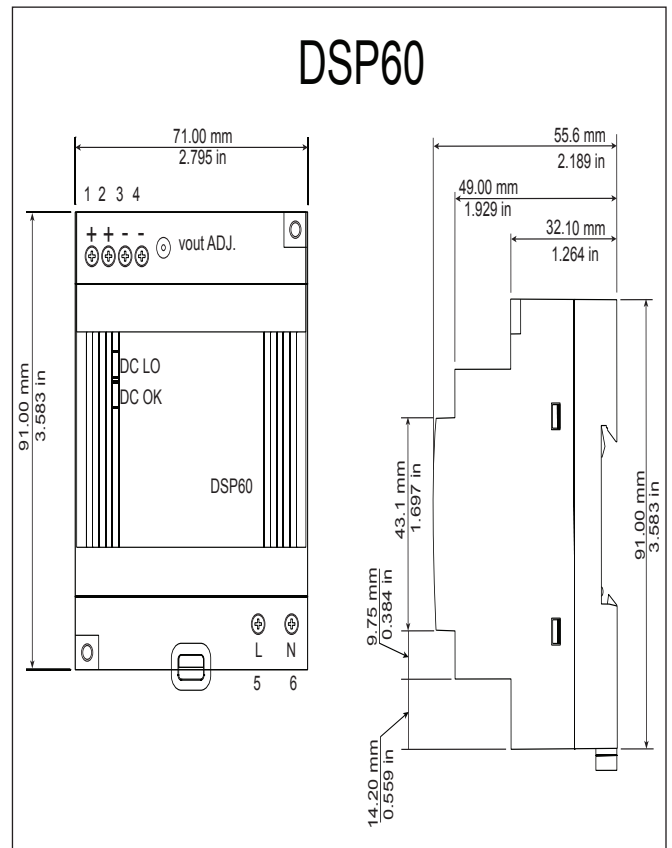
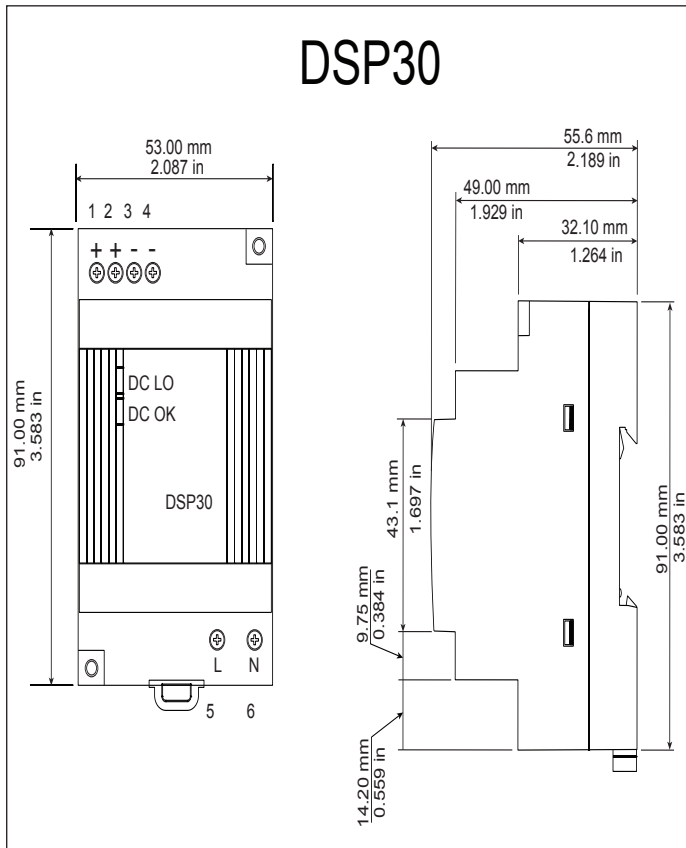

Power Supply Specifications

		DSP 30	DSP60	DSP100
AC Input Voltage Range	VAC	90 - 264VAC, Class II double insulated (No ground connection required)		
Input Frequency	Hz	47 - 63Hz		
DC Input Voltage range	VDC	120 - 370VDC		
Inrush Current (115 / 230VAC)	A	25 / 50A	30 / 60A	30 / 60A
Output Voltage Accuracy	%	±1% of Nominal		
Over voltage Protection	V	120 - 145%		
LED Indicators	----	Green LED = On, Red LED = DC Output Low		
Operating Temperature	----	-25 to +71°C (Derate linearly 2.5%/°C from 55 to 71°C)		
Storage Temperature	----	-25 to +85°C		
Operating Humidity	----	20 - 95% RH (non condensing)		
Vibration (Operating)	----	IEC 60068-2-6 (Mounting by rail: Random wave, 10-500 Hz, 2G, ea. along X, Y, Z axes 10 min/cycle, 60 min)		
Safety Agency Approvals		UL1310 Class 2(1), UL508 Listed, UL60950-1, EN60950-1, CE		

For a comprehensive listing of these specifications point your browser to : <http://us.tdk-lambda.com/lp/products/dsp-series.htm>

RML Installation and Removal on a DIN Rail

Modular Backplane Connector

The picture on the right shows the Modular Backplane Connector, both front and rear view. The rear view is bringing in to focus a metal clip. If the DIN rail is grounded the Modular Backplane Connector and the module connected to it will be also (recommended).

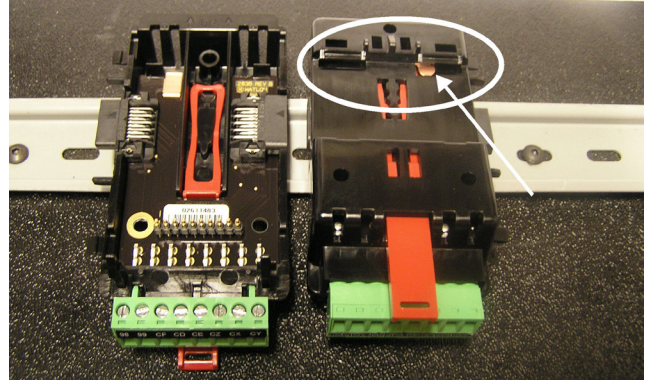

Installing the Modular Backplane Connector

Step 1

Hook backplane assembly to upper edge of DIN rail, (see rear view above, backplane hook detail that mates with upper rail edge is circled)

Step 2

Next, rotate back plane assembly downward to engage the lower edge of the rail. (Note: Din Rail clipping distance ranges from 1.366 -1.389 inches. The backplane assembly will not latch onto the rail successfully if the rail is out of dimension).

Step 3

For final positioning and locking, the red tab is to be pushed upward to further engage the bottom edge of the rail with an over center snap action latch. (The red locking tab protrudes from the bottom side of the back plane assembly).

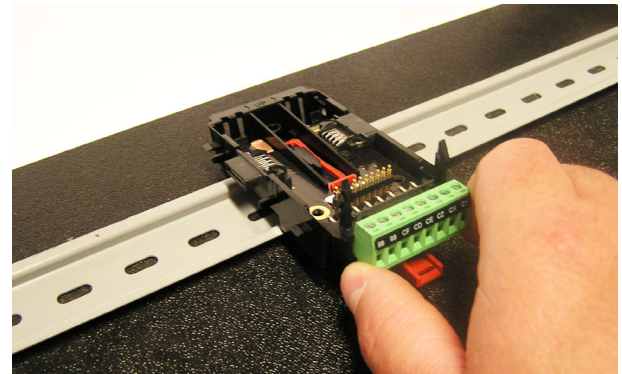

Installing Multiple Modular Backplane Connectors

Multiple modules are easily aligned and latched together. Each module includes matched mating geometry that facilitates accurate and consistent interconnections. The recommended method of multi-module attachment is to first attach individual modules to the rail separately and second to laterally slide the modules together until they touch. (Refer to steps 1&2 above). When the multi-module system is attached and laterally positioned to the desired placement the locking tab should be engaged to secure the control system to the rail, (Refer to step 3 above).

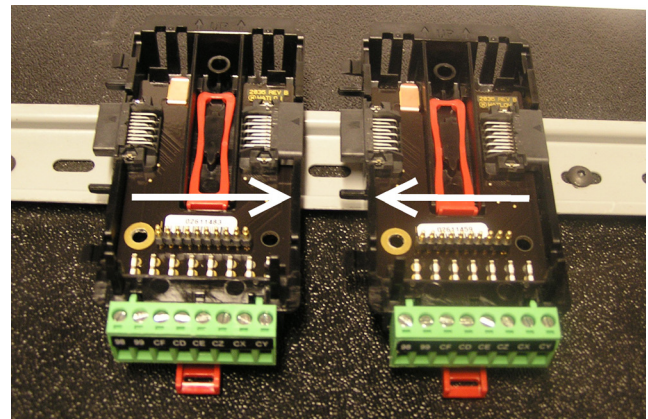

Module Installation

In the picture to the right notice that the arrow is pointing at the top lip of the module (on side). When installing the module simply slide this lip over the top of the Modular Backplane Connector and then push down on the rear of the module where it will seat on the two posts just above the green connector.

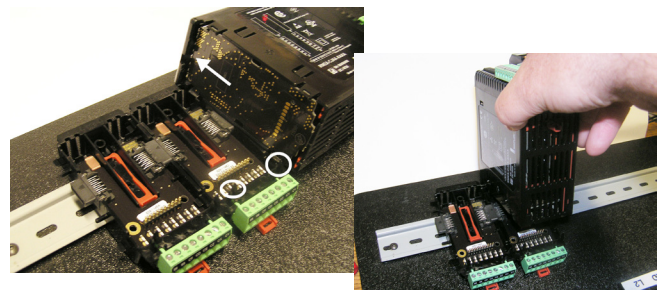

Module Removal

To remove a module from the Modular Backplane Connector find the red tab protruding from the bottom of the module and pull back on it as shown to the right. While pulling back on the red tab the two mounting posts will release the module where the module can then be lifted up and out of the Modular Backplane Connector.

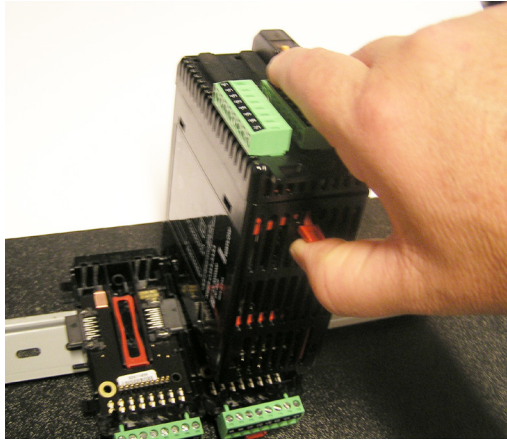

Removal of the Modular Backplane Connector

A module can be removed from the Modular Backplane Connector by inserting a screw driver into the red locking tab just behind the green connector and applying downward pressure on the tab by lifting the screwdriver upwards. When released, the tab will move downward and the connector can then be lifted up off of the DIN rail.

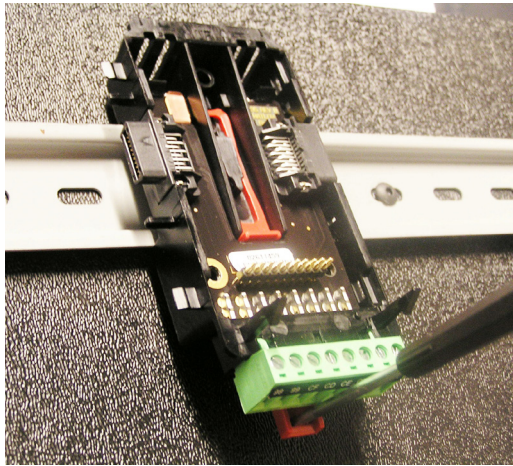

Wiring

Limit Module (RMLx-xxxx-xxxx)					
Slot A	Slot B	Slot D	Slot E	Configuration	
Universal, RTD and Thermistor Inputs 1 -12					
1 - 4	5 - 8	9 - 12	---		
S1 R1 S2 R2 S3 R3 S4 R4	S5 R5 S6 R6 S7 R7 S8 R8	S9 R9 S10 R10 S11 R11 S12 R12	---	S_ (RTD), thermocouple -, volts -, mA - or thermistor R_ (RTD), thermocouple +, volts +, mA + or thermistor	Universal/Thermistor Input Part # Digits 5, 6, 7 Input 1-4: RMLx-(5,6)xxx-xxxx Input 5-8: RMLx-x(5,6)xx-xxxx Input 9-12: RMLx-xx(5,6)x-xxxx
Digital Inputs 1 - 6					
---	---	1 - 6	---		
---	---	B1 D1 D2 D3 D4 D5 D6 Z1	---	Common DC +input DC +input DC +input DC +input DC +input DC +input Internal Supply	Digital Inputs (DI) Part # Digit 7 Slot A: Option not valid Slot B: Option not valid Slot D: RMLx-xx(C)x-xxxx Slot E: Option not valid
Digital Input 9					
---	---	---	9		
---	---	---	---	Common DC +input	Digital Input (DI) Part # Digit 8 Slot A: Option not valid Slot B: Option not valid Slot D: Option not valid Slot E: RMLx-xxx(B)-xxxx
Form A - Mechanical Relay Outputs 1- 4 and 7 - 10					
---	----	1 - 4	7 - 10		
---	---	L1 K1 L2 K2 L3 K3 L4 K4	L7 K7 L8 K8 L9 K9 L10 K10	normally open common normally open common normally open common normally open common	Mechanical Relay 5 A, Form A Part # Digits 7, 8 Slot D: : RMLx-xx(J)x-xxxx Slot E: : RMLx-xxx(J)-xxxx
Form C - Mechanical Relay Output 7 and Form A - Mechanical Relay Output 8					
---	----	---	7 and 8		
---	---	---	L7 K7 J7 L8 K8	normally open common normally closed normally open common	Form C and Form A Relay Outputs Part # Digit 8 Slot A: Option not valid Slot B: Option not valid Slot D: Option not valid Slot E: RMLx-xxx(B)-xxxx

Digital Outputs 1 - 6					
Slot A	Slot B	Slot D	Slot E		Configuration
---	---	1 - 6	---		
---	---	B1	---	Common	Digital Outputs (DO) Part # Digit 7 Slot A: Option not valid Slot B: Option not valid Slot D: RMLx-xx(C)x-xxxx Slot E: Option not valid
---	---	D1	---	open collector/ switched dc	
---	---	D2	---	open collector/ switched dc	
---	---	D3	---	open collector/ switched dc	
---	---	D4	---	open collector/ switched dc	
---	---	D5	---	open collector/ switched dc	
---	---	D6	---	open collector/ switched dc	
---	---	Z1	---	Internal Supply	

Power and Communications		
Slot C		Configuration
98 99	Power input: ac or dc+ Power input: ac or dc-	All
CF CD CE	Standard Bus EIA-485 common Standard Bus EIA-485 T-/R- Standard Bus EIA-485 T+/R+	Standard Bus Part # Digit 10 RMLx-xxxx-x(A)xx
CC CA CB	Standard Bus or Modbus RTU EIA-485 common Standard Bus or Modbus RTU EIA-485 T-/R- Standard Bus or Modbus RTU EIA-485 T+/R+	Standard Bus or Modbus Part # Digit 10 RMLx-xxxx-x(1)xx
CZ CX CY	Inter-module Bus Inter-module Bus Inter-module Bus	Inter-module Bus

RML Module - Front View - Standard Connector

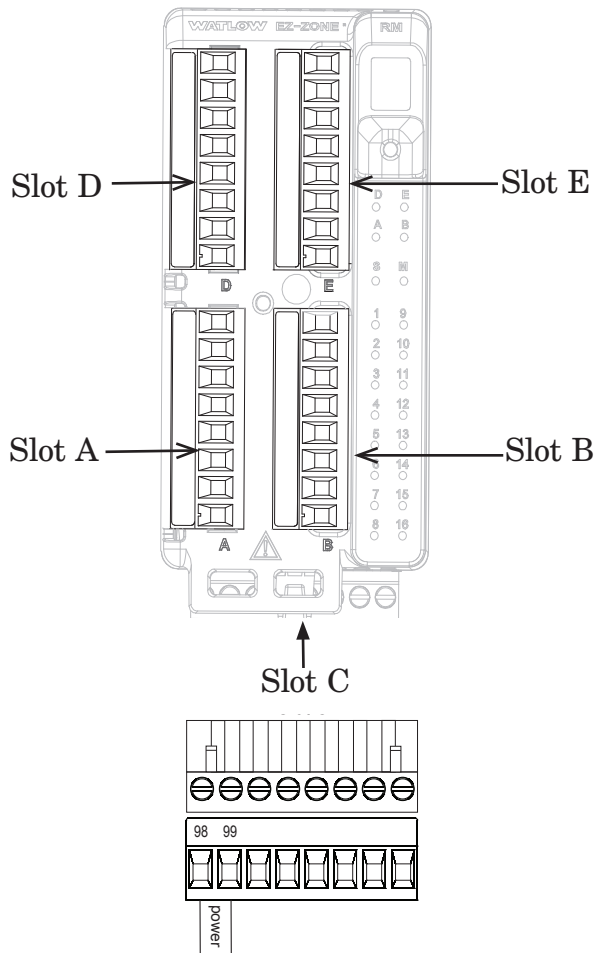

RML System Isolation Blocks

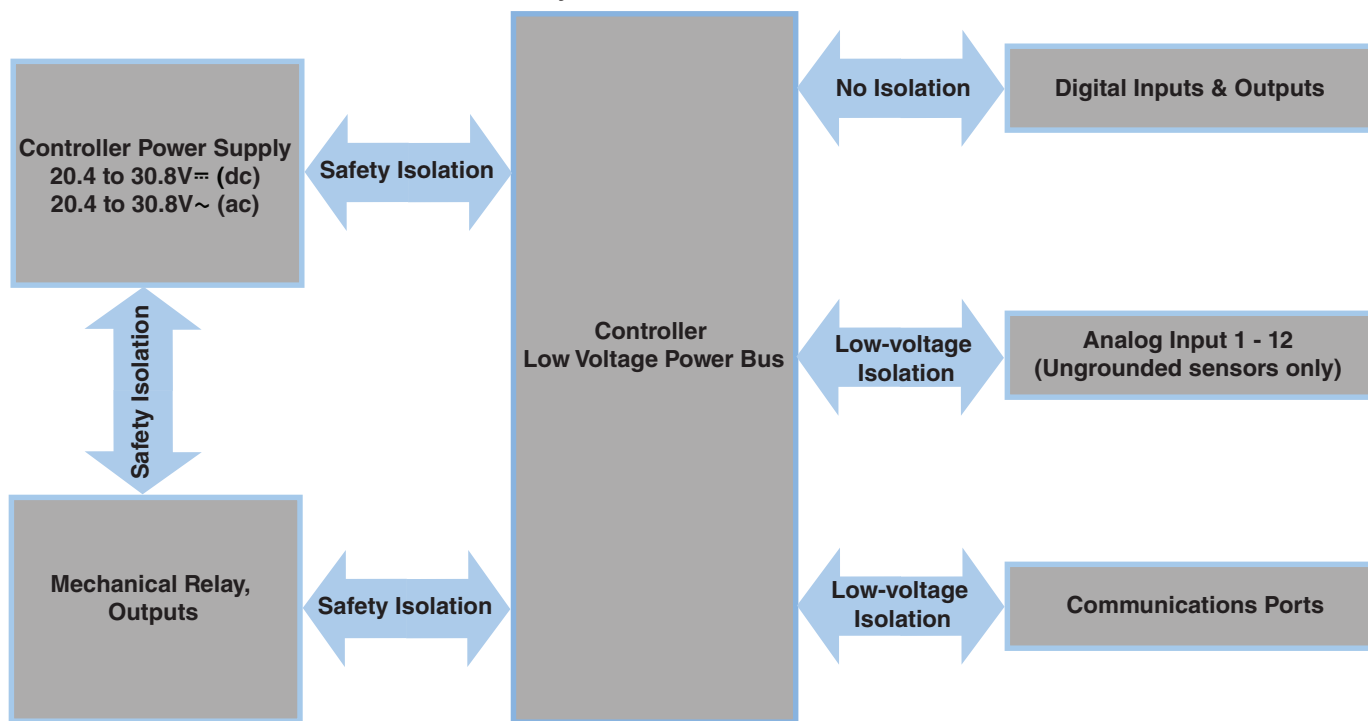

Low-voltage Isolation: 42V peak
Safety Isolation: 1,528V \sim (ac)

Limit Module Wiring (RMLx-xxxx-xxxx)

Warning:



Use National Electric (NEC) or other country-specific standard wiring and safety practices when wiring and connecting this controller to a power source and to electrical sensors or peripheral devices. Failure to do so may result in damage to equipment and property, and/or injury or loss of life.

Note:

Maximum wire size termination and torque rating:

- 0.0507 to 3.30 mm² (30 to 12 AWG) single-wire termination or two 1.31 mm² (16 AWG)
- 0.8 Nm (7.0 in-lb.) torque

Note:

Adjacent terminals may be labeled differently, depending on the model number.

Note:

To prevent damage to the controller, do not connect wires to unused terminals.

Note:

Maintain electrical isolation between digital input-outputs, switched dc/open collector outputs and process outputs to prevent ground loops.

Low Power

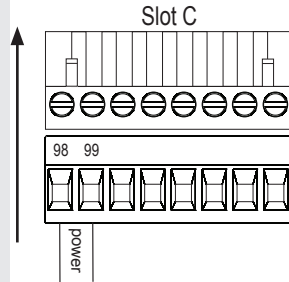

RML- ALL Model Numbers

- 20.4 to 30.8 V ~ (ac) / = (dc)
- 47 to 63 Hz
- Module maximum power consumption, 14 VA (ac), 7 VA (dc)
- 31 Watts maximum power available for P/S part #:0847-0299-0000
- 60 Watts maximum power available for P/S part #:0847-0300-0000
- 91 Watts maximum power available for P/S part #:0847-0301-0000
- Class 2 or SELV power source required to meet UL compliance standards

Communications

RML Part # Digit 10 is A

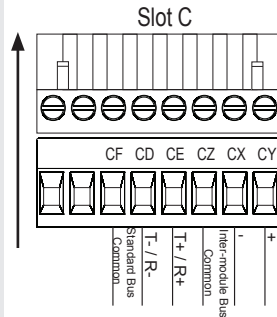

- CF, CD, CE - Standard Bus EIA485 Communications
- CZ, CX, CY - Inter-module Bus EIA485 Communications
- Do not route network wires with power wires. Connect network wires in daisy-chain fashion when connecting multiple devices in a network

Communications

RML Part # Digit 10 is 1

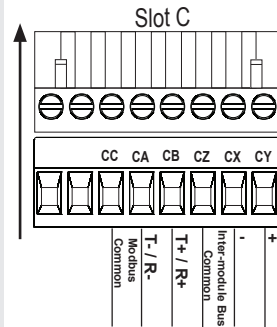

- CC, CA, CB - Modbus and Standard Bus EIA485 Communications (selectable via push button under zone address)
- CZ, CX, CY - Inter-module Bus EIA485 Communications
- Do not route network wires with power wires. Connect network wires in daisy-chain fashion when connecting multiple devices in a network

Inputs 1 through 12 Thermocouple

RML Part # Digits 5, 6, 7

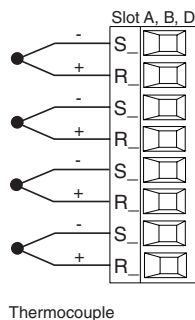

- 2K Ω maximum source resistance
- >20 MΩ input impedance
- 3 microampere open-sensor detection
- Thermocouples are polarity sensitive. The negative lead (usually red) must be connected to S terminal
- To reduce errors, the extension wire for thermocouples must be of the same alloy as the thermocouple.

Input 1 - 4 (top to bottom): RMLx-(5)xxx-xxxx

Input 5 - 8 (top to bottom): RMLx-x(5)xx-xxxx

Input 9 - 12 (top to bottom): RMLx-xx(5)x-xxxx

Warning:



Use National Electric (NEC) or other country-specific standard wiring and safety practices when wiring and connecting this controller to a power source and to electrical sensors or peripheral devices. Failure to do so may result in damage to equipment and property, and/or injury or loss of life.

Note:

Maximum wire size termination and torque rating:

- 0.0507 to 3.30 mm² (30 to 12 AWG) single-wire termination or two 1.31 mm² (16 AWG)
- 0.8 Nm (7.0 in.-lb.) torque

Note:

Adjacent terminals may be labeled differently, depending on the model number.

Note:

To prevent damage to the controller, do not connect wires to unused terminals.

Note:

Maintain electrical isolation between digital input-outputs, switched dc/open collector outputs and process outputs to prevent ground loops.

Inputs 1 through 12 RTD

RML Part # Digits 5, 6, 7

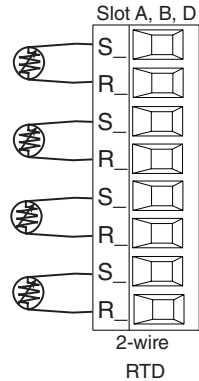

- platinum, 100 and 1,000 Ω @ 0°C
 - calibration to DIN curve (0.00385 Ω/Ω°C)
 - 20 Ω total lead resistance
 - RTD excitation current of 0.09 mA typical. Each ohm of lead resistance may affect the reading by 2.55°C.
- Input 1 - 4 (top to bottom): RMLx-(5)xxx-xxxx
 Input 5 - 8 (top to bottom): RMLx-x(5)xx-xxxx
 Input 9 - 12 (top to bottom): RMLx-xx(5)x-xxxx

AWG	Ohms/1000ft
14	2.575
16	4.094
18	6.510
20	10.35
22	16.46
24	26.17
26	41.62
28	66.17

Inputs 1 through 12 Thermistor

RML Part # Digits 5, 6, 7

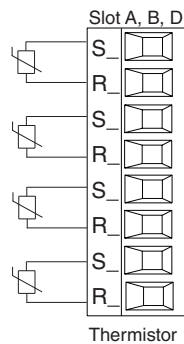

- >20 MΩ input impedance
- Input 1 - 4 (top to bottom): RMLx-(6)xxx-xxxx
 Input 5 - 8 (top to bottom): RMLx-x(6)xx-xxxx
 Input 9 - 12 (top to bottom): RMLx-xx(6)x-xxxx

Digital Inputs 1 through 6 and 9

RML Part # Digit 7, 8 is C and or B Respectively

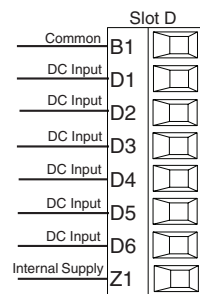

Digital Input Event Conditions

- Dry Contact
 - Input inactive when > 100KΩ
 - Input active when < 50Ω
- Voltage
 - Input inactive when < 2V
 - Input active when > 3V
- Six user configurable digital inputs/outputs per slot
 - Slot D DI 1 - 6 RMLx-x(C)xx-xxxx
 - Slot E DI 9 RMLx-xxx(B)-xxxx

Note:

When using a dry contact with Digital Input 9 (Slot E), notice that the connection is made between pins B9 and D9.

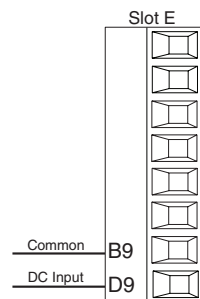

Voltage Input

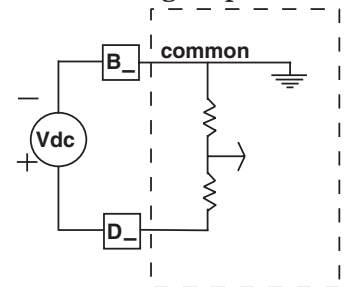

Dry Contact

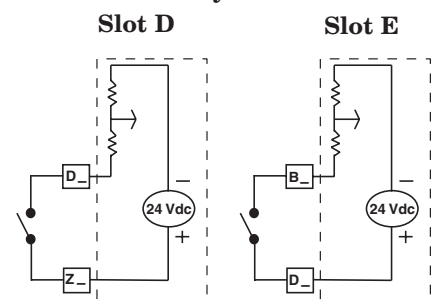

Warning: 

Use National Electric (NEC) or other country-specific standard wiring and safety practices when wiring and connecting this controller to a power source and to electrical sensors or peripheral devices. Failure to do so may result in damage to equipment and property, and/or injury or loss of life.

Note:

Maximum wire size termination and torque rating:

- 0.0507 to 3.30 mm² (30 to 12 AWG) single-wire termination or two 1.31 mm² (16 AWG)
- 0.8 Nm (7.0 in-lb.) torque

Note:

Adjacent terminals may be labeled differently, depending on the model number.

Note:

To prevent damage to the controller, do not connect wires to unused terminals.

Note:

Maintain electrical isolation between digital input-outputs, switched dc/open collector outputs and process outputs to prevent ground loops.

Suppressor Note:

Switching pilot duty inductive loads (relay coils, solenoids, etc.) with the mechanical relay, solid state relay or open collector output options requires use of an R.C. suppressor.

Process Inputs 1 through 12

RML Part # Digit 5, 6, 7 is 5

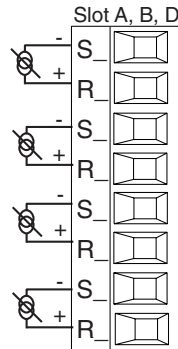
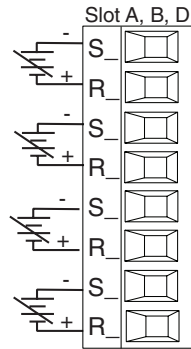

- 0 to 20 mA @ 100 Ω input impedance
- 0 to 10V_{rms} (dc) @ 20 kΩ input impedance
- 0 to 50 mV_{rms} (dc) @ 20 MΩ input impedance
- scalable

Slot 1: RMLx-(5)xxx-xxxx
(Inputs 1 to 4)

Slot 2: RMLx-x(5)xx-xxxx
(Inputs 5 to 8)

Slot 3: RMLx-xx(5)x-xxxx
(Inputs 9 to 12)

Digital Outputs 1 - 6

RML Part # Digit 7 is C

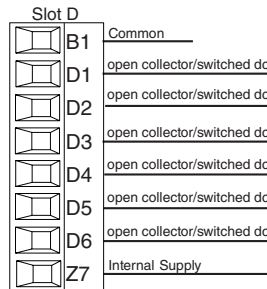

- Maximum switched voltage is 32V_{rms} (dc)
- Internal supply provides a constant power output of 750mW
- Maximum output sink current per output is 1.5A (external class 2 or *SELV supply required)
- Total sink current for all outputs not to exceed 8A
- Do not connect outputs in parallel
 - Slot D DO 1 - 6
 - RMLx-xx(C)x-xxxx

*Saftey Extra Low Voltage

Open Collector/Switched DC Outputs

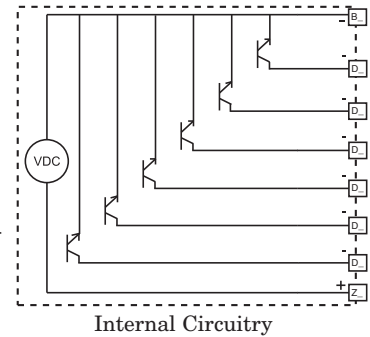

Warning:



Use National Electric (NEC) or other country-specific standard wiring and safety practices when wiring and connecting this controller to a power source and to electrical sensors or peripheral devices. Failure to do so may result in damage to equipment and property, and/or injury or loss of life.

Note:

Maximum wire size termination and torque rating:

- 0.0507 to 3.30 mm² (30 to 12 AWG) single-wire termination or two 1.31 mm² (16 AWG)
- 0.8 Nm (7.0 in.-lb.) torque

Note:

Adjacent terminals may be labeled differently, depending on the model number.

Note:

To prevent damage to the controller, do not connect wires to unused terminals.

Note:

Maintain electrical isolation between digital input-outputs, switched dc/open collector outputs and process outputs to prevent ground loops.

Switched DC Wiring Example Using DO 1-6

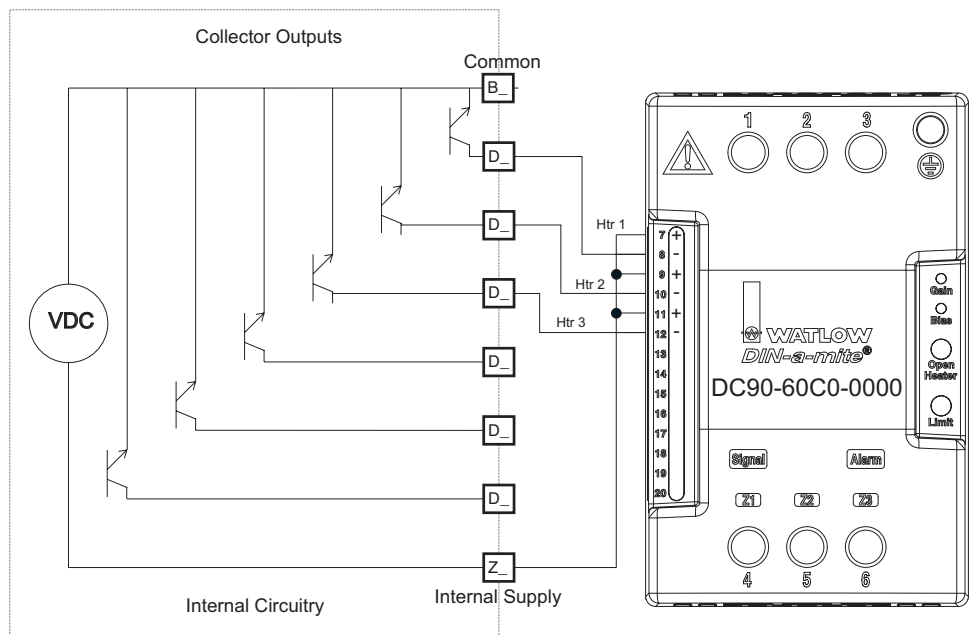

Note:

As a switched DC output; this output is a constant current output delivering 750 mW, current limited to 400 mA. The internal supply does have a maximum open circuit voltage of 22 VDC and minimum open circuit voltage of 19 VDC. Pin Z1 is shared to all digital outputs. This type of output is meant to drive solid state relays, not mechanical relays.

Open Collector Wiring Example Using DO 1-6

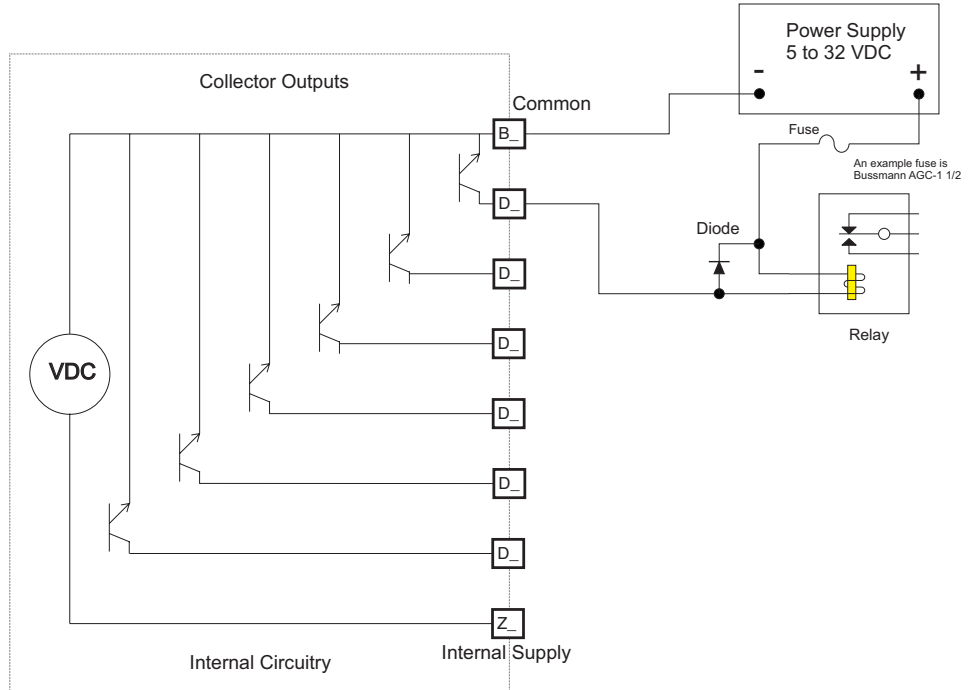

As an open collector output (see graphic below), use an external power supply with the negative wired to B1, the positive to the coil of a pilot mechanical relay and the other side of the coil wired to the output of choice (D_n). Each open collector output can sink 1.5 A with the total for all open collector outputs not exceeding 8 amperes. Ensure that a kickback diode is reversed wired across the relay coil to prevent damage to the internal transistor.

Warning: 

Use National Electric (NEC) or other country-specific standard wiring and safety practices when wiring and connecting this controller to a power source and to electrical sensors or peripheral devices. Failure to do so may result in damage to equipment and property, and/or injury or loss of life.

Note:

Maximum wire size termination and torque rating:

- 0.0507 to 3.30 mm² (30 to 12 AWG) single-wire termination or two 1.31 mm² (16 AWG)
- 0.8 Nm (7.0 in.-lb.) torque

Note:

Adjacent terminals may be labeled differently, depending on the model number.

Note:









To prevent damage to the controller, do not connect wires to unused terminals.

Note:

Maintain electrical isolation between digital input-outputs, switched dc/open collector outputs and process outputs to prevent ground loops.

Output 1 - 4 and 7 - 10 Mechanical Relay, Form A

RML Part # Digit 7, 8 is J

Slot D	
	L1 normally open
	K1 common
	L2 normally open
	K2 common
	L3 normally open
	K3 common
	L4 normally open
	K4 common

- 5 A at 240V~ (ac) or 30V= (dc) maximum resistive load
 - 20 mA at 24V minimum load
 - 125 VA pilot duty @ 120/240V~ (ac), 25 VA at 24V~ (ac)
 - 100,000 cycles at rated load
 - Output does not supply power.
 - for use with ac or dc
- See Quencharc note.







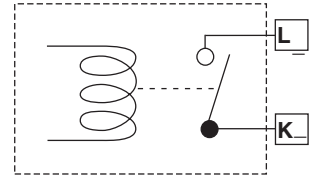

- Slot D Outputs 1 - 6
RMLx-xx(J)x-xxxx

- Slot E Outputs 7 - 10
RMLx-xxx(J)-xxxx

Mechanical Relay Form A







Internal Circuitry

Slot E	
	L7 normally open
	K7 common
	L8 normally open
	K8 common
	L9 normally open
	K9 common
	L10 normally open
	K10 common

Output 7 and 8 Mechanical Relays, Form A

RML Part # Digit 8 is B

Slot E	
	L7 normally open
	K7 common
	J7 normally closed
	L8 normally open
	K8 common

- 5 A at 240V~ (ac) or 30V= (dc) maximum resistive load
 - 20 mA at 24V minimum load
 - 125 VA pilot duty at 120/240V~ (ac), 25 VA at 24V~ (ac)
 - 100,000 cycles at rated load
 - Output does not supply power.
 - for use with ac or dc
- See Quencharc note.

- Slot E Output 7
RMLx-xxx(B)-xxxx

Mechanical Relay Form C

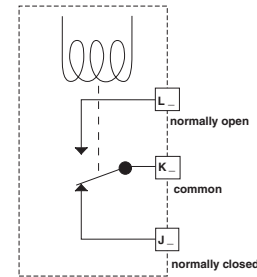

- 5 A at 240V~ (ac) or 30V= (dc) maximum resistive load
 - 20 mA at 24V minimum load
 - 125 VA pilot duty @ 120/240V~ (ac), 25 VA at 24V~ (ac)
 - 100,000 cycles at rated load
 - Output does not supply power.
 - for use with ac or dc
- See Quencharc note.

- Slot E Output 8
RMLx-xxx(B)-xxxx

Mechanical Relay Form A

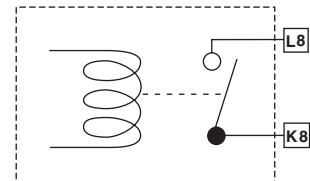

Warning:



Use National Electric (NEC) or other country-specific standard wiring and safety practices when wiring and connecting this controller to a power source and to electrical sensors or peripheral devices. Failure to do so may result in damage to equipment and property, and/or injury or loss of life.

Note:

Maximum wire size termination and torque rating:

- 0.0507 to 3.30 mm² (30 to 12 AWG) single-wire termination or two 1.31 mm² (16 AWG)
- 0.8 Nm (7.0 in.-lb.) torque

Note:

Adjacent terminals may be labeled differently, depending on the model number.

Note:

To prevent damage to the controller, do not connect wires to unused terminals.

Note:

Maintain electrical isolation between digital input-outputs, switched dc/open collector outputs and process outputs to prevent ground loops.

Quencharc Wiring Example

In this example the Quencharc circuit (Watlow part# 0804-0147-0000) is used to protect RML internal circuitry from the counter electromagnetic force from the inductive user load when deenergized. It is recommended that this or an equivalent Quencharc be used when connecting inductive loads to RML outputs.

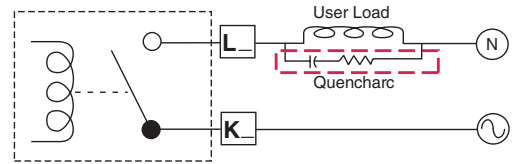

Standard Bus EIA-485 Communications

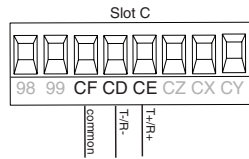

- Wire T-/R- to the A terminal of the EIA-485 port.
- Wire T+/R+ to the B terminal of the EIA-485 port.
- Wire common to the common terminal of the EIA-485 port.
- Do not route network wires with power wires. Connect network wires in daisy-chain fashion when connecting multiple devices in a network.
- A 120 Ω termination resistor may be required across T+/R+ and T-/R-, placed on the last

- controller on the network.
- Do not connect more than 16 EZ-ZONE PM controllers on a network.
- maximum network length: 1,200 meters (4,000 feet)
- 1/8th unit load on EIA-485 bus

RMLx-xxxx-x(A)xx

* All models include Standard Bus communications

Note:

Do not leave a USB to EIA-485 converter connected to Standard Bus without power (i.e., disconnecting the USB end from the computer while leaving the converter connected on Standard Bus). Disturbance on the Standard Bus may occur.

Modbus RTU or Standard Bus EIA-485 Communications

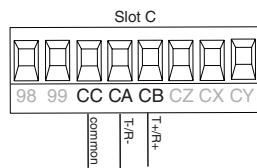

- Wire T-/R- to the A terminal of the EIA-485 port.
- Wire T+/R+ to the B terminal of the EIA-485 port.
- Wire common to the common terminal of the EIA-485 port.
- Do not route network wires with power wires. Connect network wires in daisy-chain fashion when connecting multiple devices in a network.
- A termination resistor may be required. Place a 120 Ω resistor across T+/R+ and T-/R- of last controller on network.

- Only one protocol per port is available at a time: either Modbus RTU or Standard Bus.
- Do not connect more than 16 EZ-ZONE controllers on a Standard Bus network.
- Maximum number of EZ-ZONE controllers on a Modbus network is 247.
- maximum network length: 1,200 meters (4,000 feet)
- 1/8th unit load on EIA-485 bus

RMLx-xxxx-x(1)xx

Note:

Do not leave a USB to EIA-485 converter connected to Standard Bus without power (i.e., disconnecting the USB end from the computer while leaving the converter connected on Standard Bus). Disturbance on the Standard Bus may occur.

Modbus-IDA Terminal	EIA/TIA-485 Name	Watlow Terminal Label	Function
DO	A	CA or CD	T-/R-
D1	B	CB or CE	T+/R+
common	common	CC or CF	common

**EZ-ZONE® RM
to B&B Converter
Model ULINX™ 485USBTB-2W
USB to RS-485 Adapter
using Standard Bus**

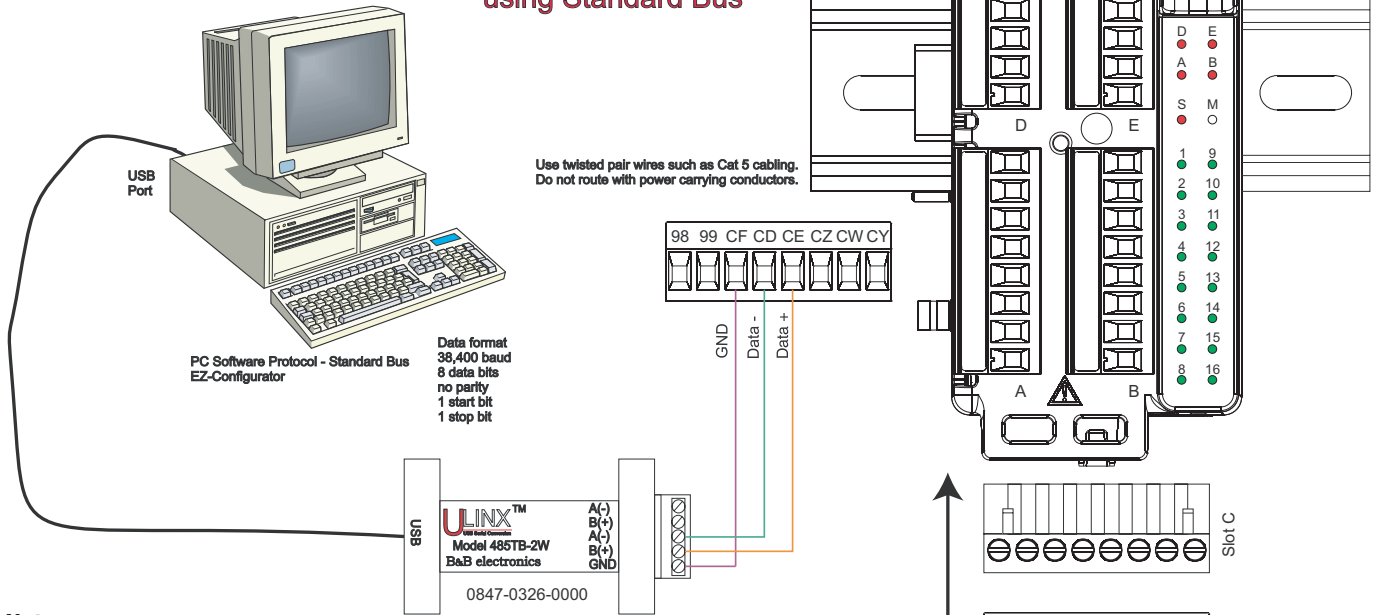

Note:
Do not leave a USB to EIA-485 converter connected to Standard Bus without power (i.e., disconnecting the USB end from the computer while leaving the converter connected on Standard Bus). Disturbance on the Standard Bus may occur.

**EZ-ZONE® RM
to B&B Converter
Model ULINX™ 485USBTB-2W
USB to RS-485 Adapter
using Modbus RTU**

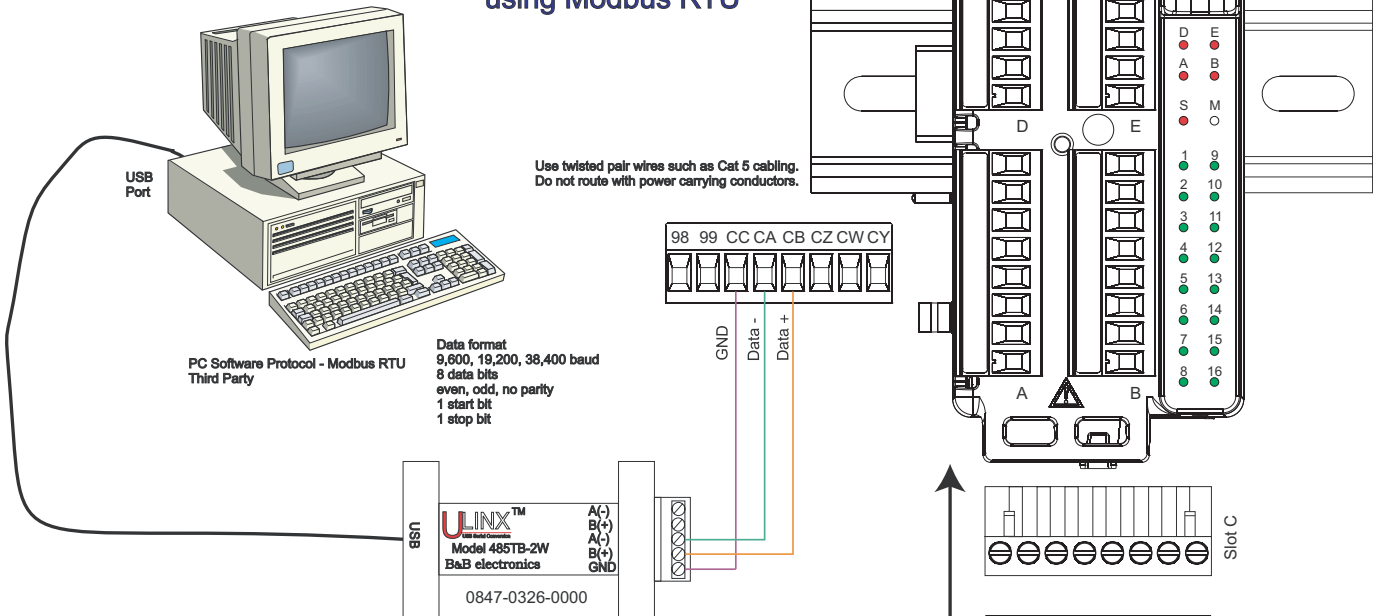

Note:
Do not leave a USB to EIA-485 converter connected to Standard Bus without power (i.e., disconnecting the USB end from the computer while leaving the converter connected on Standard Bus). Disturbance on the Standard Bus may occur.

Wiring a Serial EIA-485 Network

Do not route network wires with power wires. Connect network wires in daisy-chain fashion when connecting multiple devices in a network.

A network using Watlow's Standard Bus and an RUI/Gate way.

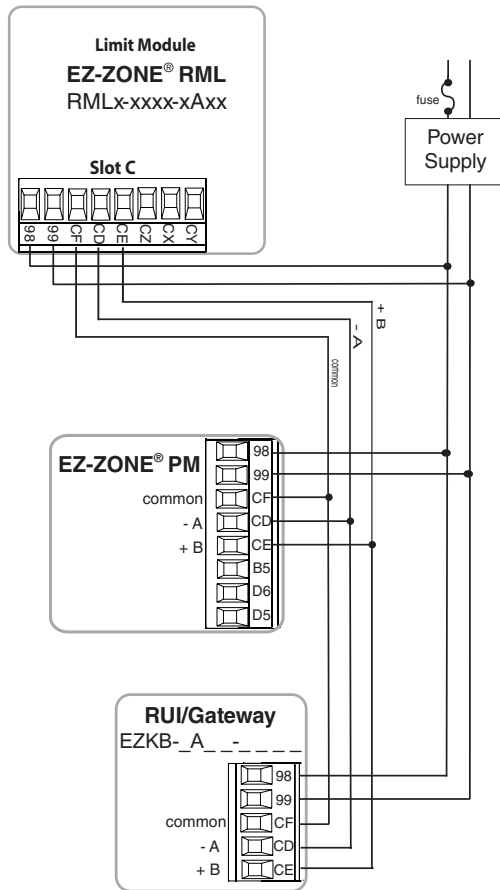

A termination resistor is required. Place a 120 Ω resistor across T+/R+ and T-/R- of the last controller on a network.

Only one protocol per port is available at a time: either Modbus RTU or Standard Bus.

A network using Modbus RTU

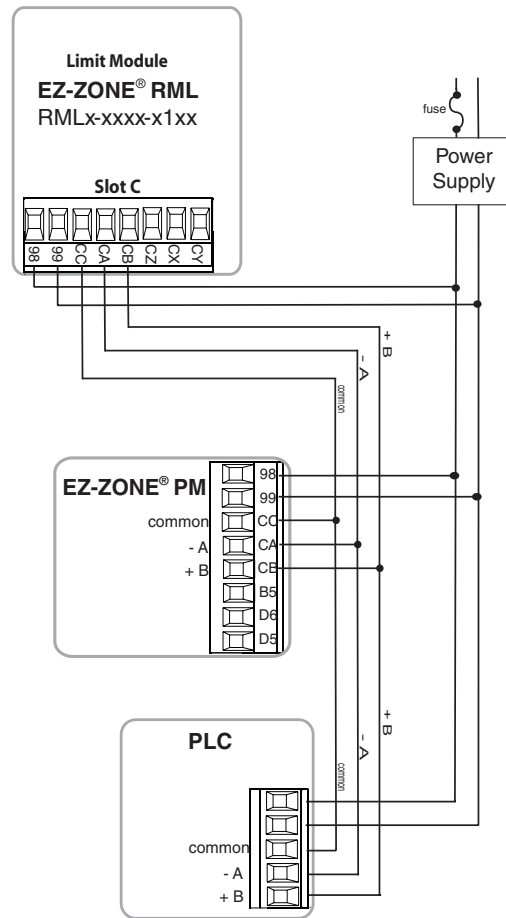

Connecting and Wiring the Modules

RML Module Connections

The RML module can be installed as a stand-alone limit controller or can be interconnected on the DIN rail as shown below with other RM family modules. When modules are connected together as shown, power and communications are shared between modules over the modular backplane interconnection. Therefore, bringing the necessary power and communications wiring to any one connector in slot C is sufficient. The modular backplane interconnect comes standard with every module ordered and is generic in nature, meaning any RM modules shown below on the DIN rail can use it.

Modular Backplane Interconnect

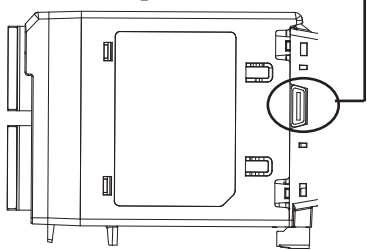

Notice in the split rail system diagram that a single power supply is being used across both DIN rails. One notable consideration when designing the hardware layout would be the available power supplied and the loading affect of all of the modules used. Watlow provides three options for power supplies listed below:

1. 90-264 Vac to 24Vdc @ 31 watts (Part #: 0847-0299-0000)
2. 90-264 Vac to 24Vdc @ 60 watts (Part #: 0847-0300-0000)
3. 90-264 Vac to 24Vdc @ 91 watts (Part #: 0847-0301-0000)

With regards to the modular loading affect, maximum power for each RM module is listed below:

1. RMCxxxxxxxxxxxx @ 7 watts / 14VA
2. RMEx-xxxx-xxxx @ 7 watts / 14VA
3. RMAx-xxxx-xxxx @ 4 watts / 9VA
4. **RMLx-xxxx-xxxx @ 7 watts / 14VA**
5. RMHx-xxxx-xxxx @ 7 watts / 14VA
6. RMSx-xxxx-xxxx @ 7 watts / 14VA

So, in the split rail system diagram, the maximum current draw on the supply would be 38 Watts.

- 2 RMC modules consumes 14W
- **1 RML module consumes 7W**
- 1 RME modules consumes 7W
- 1 RMA module consumes 4W
- 1 Remote User Interface consumes 6W

With this power requirement (38 watts) the second or third power supply could be used.

Another hardware configuration scenario that could present itself (graphic not shown) would be a con-

figuration that requires more than one supply. Lets make some assumptions pertaining to the split rail system diagram shown below. The power supply used is the 91W supply. The top DIN rail now has the following modules:

- 2 RMC modules consumes 14W
- 1 RMA consumes 4W
- 11 RME modules consumes 77W
- **2 RML modules consumes 14W**

As can now be seen, the total power requirement exceeds 91W. In this case, another power supply would be required. To incorporate another supply in this system simply disconnect pins 99 and 98 on the remote DIN rail and connect another appropriately sized power supply for the remote modules to those same pins.

When using a split rail configuration ensure that the interconnections for the Inter-module Bus and Standard Bus do not exceed 100 feet.

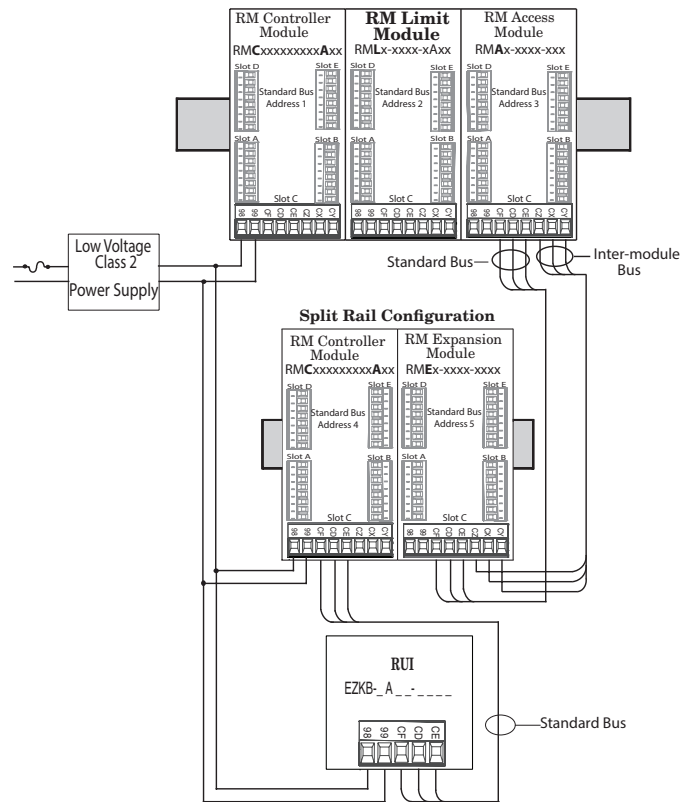

Note:

The Inter-module bus as shown above is a required connection between split rails for the purpose of sharing function block data.

Note:

Unit is not provided with a disconnect, use of an external disconnect is required. It should be located in close proximity to the unit and be labeled as the disconnect for the unit.

Conventions Used in the Menu Pages

To better understand the menu pages that follow review the naming conventions used. When encountered throughout this document, the word "default" implies as shipped from the factory. Each page (Operations, Setup and Factory) and their associated menus have identical headers defined below:

Header Name	Definition
Display	Visually displayed information from the control.
Parameter Name	Describes the function of the given parameter.
Range	Defines options available for this prompt, i.e., min/max values (numerical), yes/no, etc... (further explanation below).
Default	Values as delivered from the factory.
Modbus Relative Address	Identifies unique parameters using either the Modbus RTU or Modbus TCP protocols (further explanation below).
CIP (Common Industrial Protocol)	Identifies unique parameters using either the DeviceNet or EtherNet/IP protocol (further explanation below).
Profibus Index	Identifies unique parameters using Profibus DP protocol (further explanation below).
Parameter ID	Identifies unique parameters used with other software such as, LabVIEW.
Data Type R/W	uint = Unsigned 16 bit integer dint = long, 32-bit string = ASCII (8 bits per character) float = IEEE 754 32-bit RWES = R eadable W ritable E EPROM (saved) S et (saved)

Remote User interface (RUI) Display

Visual information from the control is displayed to the observer using a fairly standard 7 segment display. Due to the use of this technology, several characters displayed need some interpretation, see the list below:

= 1	= 0	= i	= r
= 2	= A	= J	= S
= 3	= b	= K	= t
= 4	= c	= L	= u
= 5	= d	= M	= v
= 6	= E	= n	= W
= 7	= F	= o	= y
= 8	= g	= P	= Z
= 9	= h	= q	

Note:

The RUI is optional equipment.

Range

Within this column notice that on occasion there will be numbers found within parenthesis. This number represents the enumerated value for that particular selection. Range selections can be made simply by writing the enumerated value of choice using any of the available communications protocols. As an example, turn to the Setup Page and look at the Analog Input menu and then the Sensor Type prompt. To turn the sensor off simply write the value of 62 (off) to Modbus register 400418 and send that value to the control.

Communication Protocols

All RM modules come with Watlow's Standard Bus protocol used primarily for inter-module communications as well as for configuration using EZ-ZONE Configurator software (free download from Watlow's web site (<http://www.watlow.com>)). Along with Standard Bus, the RML module can also be ordered with Modbus RTU (only one protocol can be active at any given time). The RMA (Access) module has options for several different protocols listed below:

- Modbus RTU 232/485
- EtherNet/IP, Modbus TCP
- DeviceNet
- Profibus DP

Modbus RTU Protocol

All Modbus registers are 16-bits and as displayed in this guide are relative addresses (actual). Some legacy software packages limit available Modbus registers to 40001 to 49999 (5 digits). Many applications today require access to all available Modbus registers which range from 400001 to 465535 (6 digits). Watlow EZ-ZONE controllers support 6 digit Modbus registers. For parameters listed as float notice that only one (low order) of the two registers is listed, this is

true throughout this document. By default the low order word contains the two low bytes of the 32-bit parameter. As an example, look in the Operations Page for the Process Value. Find the column identified in the header as Modbus and notice that it lists register 410. Because this parameter is a float it is actually represented by registers 410 (low order bytes) and 411 (high order bytes). Because the Modbus specification does not dictate which register should be high or low order Watlow provides the user the ability to swap this order (Setup Page, **CONF** Menu) from the default low/high (**Loh**) to high/low (**hLo**).

It should also be noted that some of the cells in the Modbus column contain wording pertaining to an offset. Several parameters in the control contain more than one instance; such as, alarms (16), analog inputs (12), etc... The Modbus register shown always represents instance one. Take for an example the Alarm Silencing parameter found in the Setup Page under the Alarm menu. Instance one is shown as address 2540 and +60 is identified as the offset to the next instance. If there was a desire to read or write to the same member instance 3, simply add 120 to 2540 to find its address; in this case, the instance 3 address for Alarm Silencing is 2660.

To learn more about the Modbus protocol point your browser to <http://www.modbus.org>.

Note:

There are two columns shown in the menus that follow for communications protocols identified as CIP (Common Industrial Protocol) and Profibus. These columns will be useful if this control is used in conjunction with the RMA module or the EZ-ZONE Remote User Interface/Gateway (RUI/GTW) where those protocols can be selected as optional hardware. For this module (RML), as a secondary protocol beyond Standard Bus, Modbus RTU can be ordered as optional hardware.

To learn more about the RUI/GTW point your browser to the link below and search for keyword EZ-ZONE.

http://www.watlow.com/literature/pti_search.cfm

3

Chapter 3: Operations Pages

Navigating the Operations Page

To navigate to the Operations Page using the RUI, follow the steps below:

1. From the Home Page, press both the Up ▲ and Down ▼ keys for three seconds. [R,] will appear in the upper display and [oPEr] will appear in the lower display.
2. Press the Up ▲ or Down ▼ key to view available menus.
3. Press the Advance Key ⏩ to enter the menu of choice.
4. If a submenu exists (more than one instance), press the Up ▲ or Down ▼ key to select and then press the Advance Key ⏩ to enter.
5. Press the Up ▲ or Down ▼ key to move through available menu prompts.
6. Press the Infinity Key ∞ to move backwards through the levels: parameter to submenu; submenu to menu; menu to Home Page.
7. Press and hold the Infinity Key ∞ for two seconds to return to the Home Page.

On the following pages, top level menus are identified with a yellow background color.

Note:

Some of these menus and parameters may not appear, depending on the controller's options. See model number information in the Appendix for more information. If there is only one instance of a menu, no sub-menus will appear.

Note:

Some of the listed parameters may not be visible. Parameter visibility is dependent upon controller part number.

- [R,] Analog Input Menu
 - [i] to [12]
 - [R,] Analog Input
 - [R,0] Process Value
 - [,Er] Error Status
 - [,LR] Calibration Offset
- [d,0] Digital Input/Output Menu
 - [i] to [6] and [9]
 - [d,0] Digital Input/Output
 - [d,5] Output State
 - [d,5] Input State
- [RCE] Action Menu
 - [i] to [16]
 - [RCE] Action
 - [E,5] Event Input
- [L,17] Limit Menu
 - [i] to [12]
 - [L,17] Limit
 - [LL,5] Low Set Point
 - [LH,5] High Set Point
 - [L,CR] Clear Request
 - [L,SE] Status
- [RL17] Alarm Menu
 - [i] to [16]
 - [RL17] Alarm
 - [RL,0] Low Set Point
 - [RH,1] High Set Point
 - [R,CLR] Clear Request
 - [R,5,rr] Silence Request

- [R,SE] State
- [Lnr] Linearization Menu
 - [i] to [16]
 - [Lnr] Linearization
 - [Su,A] Source Value A
 - [oFSE] Offset
 - [o,v] Output Value
- [CPE] Compare Menu
 - [i] to [16]
 - [CPE] Compare
 - [Su,A] Source Value A
 - [Su,b] Source Value B
 - [o,v] Output Value
- [E17r] Timer Menu
 - [i] to [16]
 - [E17r] Timer
 - [Su,A] Source Value A
 - [Su,b] Source Value B
 - [E,t] Elapsed Time
 - [o,v] Output Value
- [CEr] Counter Menu
 - [i] to [16]
 - [CEr] Counter
 - [Cnt] Count
 - [Su,A] Source Value A
 - [Su,b] Source Value B
 - [o,v] Output Value
- [L9C] Logic Menu

- [i] to [16] Logic
 - [Su,A] Source Value A
 - [Su,b] Source Value B
 - [Su,C] Source Value C
 - [Su,d] Source Value D
 - [Su,E] Source Value E
 - [Su,F] Source Value F
 - [Su,G] Source Value G
 - [Su,h] Source Value H
 - [o,v] Output Value
- [17RE] Math Menu
 - [i] to [16]
 - [17RE] Math
 - [Su,A] Source Value A
 - [Su,b] Source Value B
 - [Su,C] Source Value C
 - [Su,d] Source Value D
 - [Su,E] Source Value E
 - [oFSE] Offset
 - [o,v] Output Value

Display	Parameter Name Description	Range	Default	Modbus Relative Address	CIP Class Instance Attribute hex (dec)	Profibus Index	Parameter ID	Data Type & Read/Write
<div style="border: 1px solid black; padding: 2px;"> A P E r </div> Analog Input Menu								
A i [Ain]	<i>Analog Input (1 to 12)</i> Process Value View the process value.	-1,999.000 to 9,999.000°F or units -1,128.000 to 5,537.000°C	----	410 [offset 90]	0x68 (104) 1 to 0x0C (12) 1	0	4001	float R
P u F [Pu.F]	<i>Analog Input (1 to 12)</i> Filtered Process Value View the process value when filtering is turned on..	-1,999.000 to 9,999.000°F or units -1,128.000 to 5,537.000°C	----	452 [offset 90]	0x68 (104) 1 to 0x0C (12) 0x16 (22)	----	4022	float R
i E r [i.Er]	<i>Analog Input (1 to 12)</i> Error Status View the cause of the most recent error. If the A l t t e n message is E r i 1 or E r i 2 , this parameter will display the cause of the input error.	n o n E None (61) O P E n Open (65) S h o r t e d (1 2 7) M e a s u r e m e n t E r r (1 4 0) B a d C a l i b r a t i o n (1 3 9) A m b i e n t E r r (9) R T D E r r (1 4 1) F a i l (3 2) N o t S o u r c e d (2 4 6)	None	412 [offset 90]	0x68 (104) 1 to 0x0C (12) 2	1	4002	uint R
i C A [i.CA]	<i>Analog Input (1 to 12)</i> Calibration Offset Offset the input reading to compensate for lead wire resistance or other factors that cause the input reading to vary from the actual process value.	-1,999.000 to 9,999.000°F or units -1,110.555 to 5,555.000°C	0.0	432 [offset 90]	0x68 (104) 1 to 0x0C (12) 0xC (12)	2	4012	float RWES
No Display	<i>Analog Input (1 to 12)</i> Clear Latched Input Error Clear latched input when input error condition no longer exists.	Clear Latch (1221)	----	466 [offset 90]	0x68 (104) 1 to 0x0C (12) 0x1D (29)	----	4029	uint RW
<div style="border: 1px solid black; padding: 2px;"> d i o </div> Digital Input/Output Menu								
d o S [do.S]	<i>Digital Output (1 to 8)</i> Output State View the state of this output.	o f f Off (62) o n On (63)		1862 [offset 30]	0x6A (106) 1 to 8 7	90	6007	uint R
d i S [di.S]	<i>Digital Input (1 to 6 and 9)</i> Input State View this event input state.	o f f Off (62) o n On (63)		1870 [offset 30]	0x6A (106) 1 to 6 and 9 0xB (11)	----	6011	uint R
No Display	<i>Digital Input (1 to 6 and 9)</i> Source Value A View the value of source A	-1,999.000 to 9,999.000°F or units -1,128.000 to 5,537.000°C	----	1874 [offset 30]	0x6A (106) 1 to 9 0x0D (13)	----	6013	float R
Note: Some values will be rounded off to fit in the four-character display. Full values can be read with other interfaces. If there is only one instance of a menu, no submenus will appear.								R: Read W: Write E: EEPROM S: User Set

Display	Parameter Name Description	Range	Default	Modbus Relative Address	CIP Class Instance Attribute hex (dec)	Profibus Index	Parameter ID	Data Type & Read/Write
No Display	<i>Digital Input (1 to 6 and 9)</i> Source Error View the state of this output.	None (61) Open (65) Shorted (127) Measurement Error (140) Bad Calibration Data (139) Ambient Error (9) RTD Error (141) Fail (32) Math Error (1423) Not Sourced (246) Stale (1617)	None	1878 [offset 30]	0x6A (106) 1 to 9 0x0F (15)	----	6015	uint R
No Display	<i>Digital Output (1 to 8)</i> Output State View the state of this output.	Off (62) On (63)	----	1862 [offset 30]	0x6A (106) 1 to 8 7	----	6007	uint R
<div style="border: 1px solid black; padding: 2px;"> ACT OPER Action Menu </div>								
EIS [Ei.S]	<i>Action (1 to 16)</i> Event Input Status View this input state.	OFF Off (62) ON On (63)		2218 [offset 20]	0x6E (110) 1 to 0x10 (16) 5	140	10005	uint R
No Display	<i>Function Key (1)</i> Function Key State View current state of function key 1.	Off (62) On (63)	----	----	----	----	3024	uint R
No Display	<i>Function Key (2)</i> Function Key State View current state of function key 2..	Off (62) On (63)	----	----	----	----	3030	uint R
<div style="border: 1px solid black; padding: 2px;"> LIMIT OPER Limit Menu </div>								
LLS [LL.S]	<i>Limit (1 to 12)</i> Low Set Point Set the low process value that will trigger the limit.	-1,999.000 to 9,999.000°F or units -1,128.000 to 5,537.000°C	0.0°F or units -18.0°C	1494 [offset 30]	0x70 (112) 1 to 0xC (12) 3	38	12003	float RWES
LHS [Lh.S]	<i>Limit (1 to 12)</i> High Set Point Set the high process value that will trigger the limit.	-1,999.000 to 9,999.000°F or units -1,128.000 to 5,537.000°C	0.0°F or units -18.0°C	1496 [offset 30]	0x70 (112) 1 to 0xC (12) 4	39	12004	float RWES
LCL [L.Cr]	<i>Limit (1 to 12)</i> Clear Request Clear limit once limit condition is cleared.	Clear (129) Ignore (204)	Ignore	----	----	----	12014	uint R
LSE [L.St]	<i>Limit (1 to 12)</i> Status Reflects whether or not the limit is in a safe or failed mode..	Fail (32) Safe (1667)	----	1514 [offset 30]	0x70 (112) 1 to 0xC (12) 0x0D (13)	----	12013	uint R
No Display	<i>Limit (1 to 12)</i> State Current state of limit.	Off (62) None (61) Limit High (51) Limit Low (52) Error (225)	----	1500 [offset 30]	0x70 (112) 1 to 0xC (12) 6	----	12006	uint R
<p>Note: Some values will be rounded off to fit in the four-character display. Full values can be read with other interfaces.</p> <p>If there is only one instance of a menu, no submenus will appear.</p>								R: Read W: Write E: EEPROM S: User Set

Display	Parameter Name Description	Range	Default	Modbus Relative Address	CIP Class Instance Attribute hex (dec)	Profibus Index	Parameter ID	Data Type & Read/Write
No Display	<i>Limit (1 to 12)</i> Clear Request Clear limit once limit condition is cleared.	Clear (0) No Change (255)	----	1490 [offset 30]	0x70 (112) 1 to 0xC (12) 1	----	12001	uint RW
No Display	<i>Limit (1 to 12)</i> Status Reflects whether or not the limit is in a safe or failed mode..	Fail (32) Safe (1667)	----	1500 [offset 30]	0x70 (112) 1 to 0xC (12) 0x0D (13)	----	12013	uint R
No Display	<i>Limit (1 to 12)</i> Output Value Current output state.	On (63) Off (62)	----	1502 [offset 30]	0x70 (112) 1 to 0xC (12) 7	----	12007	uint R
ALARMS OPER Alarm Menu								
<input type="checkbox"/> ALo [A.Lo]	<i>Alarm (1 to 16)</i> Low Set Point If Alarm Type (Setup Page, Alarm Menu) is set to: process - set the process value that will trigger a low alarm.	-1,999.000 to 9,999.000°F or units -1,128.000 to 5,537.000°C	32.0°F or units 0.0°C	2532 [offset 60]	0x6D (109) 1 to 0x10 (16) 2	18	9002	float RWES
<input type="checkbox"/> Ah [A.hi]	<i>Alarm (1 to 16)</i> High Set Point If Alarm Type (Setup Page, Alarm Menu) is set to: process - set the process value that will trigger a high alarm.	-1,999.000 to 9,999.000°F or units -1,128.000 to 5,537.000°C	300.0°F or units 150.0°C	2530 [offset 60]	0x6D (109) 1 to 0x10 (16) 1	19	9001	float RWES
<input type="checkbox"/> ALr [A.hi]	<i>Alarm (1 to 16)</i> Clear Request Write to this register to clear an alarm	Clear (129) Ignore (204)	Ignore	----	----	----	9026	uint RW
<input type="checkbox"/> ASir [A.Sir]	<i>Alarm (1 to 16)</i> Silence Request Write to this register to silence an alarm	Ignore (204) Silence (108)	Ignore	----	----	----	9027	uint RW
<input type="checkbox"/> ASE [A.St]	<i>Alarm (1 to 16)</i> State Current state of alarm	Startup (88) None (61) Blocked (12) Alarm low (8) Alarm high (7) Error (28)	Startup	2546 [offset 60]	0x6D (109) 1 to 0x10 (16) 0x0A (10)	----	9009	uint R
No Display	<i>Alarm (1 to 16)</i> Latched Read this register to determine if the alarm is latched	No (59) Yes (106)	No	2548 [offset 60]	0x6D (109) 1 to 0x10 (16) 0x0A (10)	----	9010	uint R
No Display	<i>Alarm (1 to 16)</i> Silenced Read this register to determine if the alarm is silenced	No (59) Yes (106)	None	2550 [offset 60]	0x6D (109) 1 to 0x10 (16) 0x0B (11)	----	9011	uint R
Note: Some values will be rounded off to fit in the four-character display. Full values can be read with other interfaces. If there is only one instance of a menu, no submenus will appear.								R: Read W: Write E: EEPROM S: User Set

Display	Parameter Name Description	Range	Default	Modbus Relative Address	CIP Class Instance Attribute hex (dec)	Profibus Index	Parameter ID	Data Type & Read/Write
No Display	<i>Alarm (1 to 16)</i> Clearable Read to determine if an alarm can be cleared	No (59) Yes (106)	None	2552 [offset 60]	0x6D (109) 1 to 0x10 (16) 0xC (12)	----	9012	uint R
No Display	<i>Alarm (1 to 16)</i> Clear Request Write to this register to clear an alarm	Clear (0) No Change (255)	None	2554 [offset 60]	0x6D (109) 1 to 0x10 (16) 0xD (13)	32	9013	uint RW
No Display	<i>Alarm (1 to 16)</i> Silence Request Write to this register to silence an alarm	Clear (0) No Change (255)	None	2556 [offset 60]	0x6D (109) 1 to 0x10 (16) 0x0E (14)	33	9014	uint RW
No Display	<i>Alarm (1 to 16)</i> Working Process Value Process value used by alarms	-1,999.000 to 9,999.000°F or units -1,128.000 to 5,537.000°C	None	2566 [offset 60]	0x6D (109) 1 to 0x10 (16) 0x13 (19)	----	9019	float R
No Display	<i>Alarm (1 to 16)</i> Output Value Current state of alarm output	On (63) Off (62)	None	2576 [offset 60]	0x6D (109) 1 to 0x10 (16) 0x18 (24)	----	9024	uint R

Lnc

oPEr

Linearization Menu

SuA [Su.A]	<i>Linearization (1 to 12)</i> Source Value A View the value of Source A.	-1,999.000 to 9,999.000°F or units -1,128.000 to 5,537.000°C		7996 [offset 70]	0x86 (134) 1 to 0x10 (16) 4	----	34004	float R
oFSt [oFSt]	<i>Linearization (1 to 12)</i> Offset Set an offset to be applied to this function's output.	-1,999.000 to 9,999.000°F or units -1,128.000 to 5,537.000°C	0	8000 [offset 70]	0x86 (134) 1 to 0x10 (16) 6	----	34006	float RWES
ou [o.v]	<i>Linearization (1 to 12)</i> Output Value View the value of this function's output.	-1,999.000 to 9,999.000°F or units -1,128.000 to 5,537.000°C		8002 [offset 70]	0x86 (134) 1 to 0x10 (16) 7	----	34007	float R
No Display	<i>Linearization (1 to 12)</i> Output Error View reported cause for linearization error	None (61) Open (65) Shorted (127) Measurement Error (140) Bad Cal Data (139) Ambient Error (9) RTD Error (141) Fail (32) Math Error (1423) Not Sourced (246) Stale (1617)		8044 [offset 70]	0x86 (134) 1 to 0x10 (16) 0x1C (28)	----	34028	uint R

Note: Some values will be rounded off to fit in the four-character display. Full values can be read with other interfaces.

If there is only one instance of a menu, no submenus will appear.

R: Read
W: Write
E: EEPROM
S: User Set

Display	Parameter Name Description	Range	Default	Modbus Relative Address	CIP Class Instance Attribute hex (dec)	Profibus Index	Parameter ID	Data Type & Read/ Write
<input type="checkbox"/> CP <input type="checkbox"/> PEr Compare Menu								
<input type="checkbox"/> SuA [Su.A]	<i>Compare (1 to 16)</i> Source Value A View the value of Source A.	-1,999.000 to 9,999.000°F or units -1,128.000 to 5,537.000°C		5922 [offset 40]	0x80 (128) 1 to 0x10 (16) 7	----	28007	float R
<input type="checkbox"/> SuB [Su.b]	<i>Compare (1 to 16)</i> Source Value B View the value of Source B.	-1,999.000 to 9,999.000°F or units -1,128.000 to 5,537.000°C		5924 [offset 40]	0x80 (128) 1 to 0x10 (16) 8	----	28008	float R
<input type="checkbox"/> o.v [o.v]	<i>Compare (1 to 16)</i> Output Value View the value of this function's output.	<input type="checkbox"/> oFF Off (62) <input type="checkbox"/> oN On (63)		5928 [offset 40]	0x80 (128) 1 to 0x10 (16) 0xA (10)	----	28010	uint R
No Display	<i>Compare (1 to 16)</i> Output Error View reported cause for compare error	None (61) Open (65) Shorted (127) Measurement Error (140) Bad Cal Data (139) Ambient Error (9) RTD Error (141) Fail (32) Math Error (1423) Not Sourced (246) Stale (1617)		5934 [offset 70]	0x80 (128) 1 to 0x10 (16) 0x0D (13)	----	28013	uint R
<input type="checkbox"/> EP <input type="checkbox"/> PEr Timer Menu								
<input type="checkbox"/> SuA [Su.A]	<i>Timer (1 to 16)</i> Value Source A View the value of Source A.	<input type="checkbox"/> oFF Off (62) <input type="checkbox"/> oN On (63)	----	7202 [offset 50]	0x83 (131) 1 to 0x10 (16) 7	----	31007	uint R
<input type="checkbox"/> SuB [Su.b]	<i>Timer (1 to 16)</i> Value Source B View the value of Source B.	<input type="checkbox"/> oFF Off (62) <input type="checkbox"/> oN On (63)	----	7204 [offset 50]	0x83 (131) 1 to 0x10 (16) 8	----	31008	uint R
<input type="checkbox"/> E.t [E.t]	<i>Timer (1 to 16)</i> Elapsed Time View the value of this function's elapsed time.	0 to 30,000.0 seconds	0	7220 [offset 50]	0x83 (131) 1 to 0x10 (16) 0x10 (16)	----	31016	float R
<input type="checkbox"/> o.v [o.v]	<i>Timer (1 to 16)</i> Output Value View the value of this function's output.	<input type="checkbox"/> oFF Off (62) <input type="checkbox"/> oN On (63)	----	7208 [offset 50]	0x83 (131) 1 to 0x10 (16) 0x11 (17)	----	31010	uint R
Note: Some values will be rounded off to fit in the four-character display. Full values can be read with other interfaces. If there is only one instance of a menu, no submenus will appear.								R: Read W: Write E: EEPROM S: User Set

Display	Parameter Name Description	Range	Default	Modbus Relative Address	CIP Class Instance Attribute hex (dec)	Profibus Index	Parameter ID	Data Type & Read/Write
No Display	<i>Timer (1 to 16)</i> Running Read to determine if timer is running	Off (62) On (63)	----	7218 [offset 50]	0x83 (131) 1 to 0x10 (16) 0x0F (15)	----	31015	uint R
No Display	<i>Timer (1 to 16)</i> Output Error View reported cause for timer error	None (61) Open (65) Shorted (127) Measurement Error (140) Bad Cal Data (139) Ambient Error (9) RTD Error (141) Fail (32) Math Error (1423) Not Sourced (246) Stale (1617)		7224 [offset 50]	0x83 (131) 1 to 0x10 (16) 0x12 (18)	----	31018	uint R
<div style="border: 1px solid black; padding: 2px;"> <input type="checkbox"/> Err <input type="checkbox"/> oPEr Counter Menu </div>								
<input type="checkbox"/> Cnt [Cnt]	<i>Counter (1 to 16)</i> Count View the function's total count.	0 to 9,999		6578 [offset 40]	0x82 (130) 1 to 0x10 (16) 0xF (15)	217	30015	uint R
<input type="checkbox"/> SuA [Su.A]	<i>Counter (1 to 16)</i> Source Value A View the value of Source A.	<input type="checkbox"/> oFF Off (62) <input type="checkbox"/> oN On (63)		6562 [offset 40]	0x82 (130) 1 to 0x10 (16) 7	----	30007	uint R
<input type="checkbox"/> SuB [Su.b]	<i>Counter (1 to 16)</i> Source Value B View the value of Source B.	<input type="checkbox"/> oFF Off (62) <input type="checkbox"/> oN On (63)		6564 [offset 40]	0x82 (130) 1 to 0x10 (16) 8	----	30008	uint R
<input type="checkbox"/> oV [o.v]	<i>Counter (1 to 16)</i> Output Value View the value of this function's output.	<input type="checkbox"/> oFF Off (62) <input type="checkbox"/> oN On (63)		6568 [offset 40]	0x82 (130) 1 to 0x10 (16) 0xA (10)	----	30010	uint R
No Display	<i>Counter (1 to 16)</i> Output Error View reported cause for counter error	None (61) Open (65) Shorted (127) Measurement Error (140) Bad Cal Data (139) Ambient Error (9) RTD Error (141) Fail (32) Math Error (1423) Not Sourced (246) Stale (1617)		6580 [offset 40]	0x82 (130) 1 to 0x10 (16) 0x10 (16)	----	30016	uint R
<p>Note: Some values will be rounded off to fit in the four-character display. Full values can be read with other interfaces.</p> <p>If there is only one instance of a menu, no submenus will appear.</p>								R: Read W: Write E: EEPROM S: User Set

Display	Parameter Name Description	Range	Default	Modbus Relative Address	CIP Class Instance Attribute hex (dec)	Profibus Index	Parameter ID	Data Type & Read/ Write
<input type="checkbox"/> L9C <input type="checkbox"/> oPEr Logic Menu								
<input type="checkbox"/> SuA [Su.A]	<i>Logic (1 to 16)</i> Source Value A View the value of Source A.	<input type="checkbox"/> oFF Off (62) <input type="checkbox"/> oN On (63)		4678 [offset 80]	0x7F (127) 1 to 0x10 (16) 0x19 (25)	----	27025	uint R
<input type="checkbox"/> SuB [Su.B]	<i>Logic (1 to 16)</i> Source Value B View the value of Source B.	<input type="checkbox"/> oFF Off (62) <input type="checkbox"/> oN On (63)		4680 [offset 80]	0x7F (127) 1 to 0x10 (16) 0x1A (26)	----	27026	uint R
<input type="checkbox"/> SuC [Su.C]	<i>Logic (1 to 16)</i> Source Value C View the value of Source C.	<input type="checkbox"/> oFF Off (62) <input type="checkbox"/> oN On (63)		4682 [offset 80]	0x7F (127) 1 to 0x10 (16) 0x1B (27)	----	27027	uint R
<input type="checkbox"/> SuD [Su.D]	<i>Logic (1 to 16)</i> Source Value D View the value of Source D.	<input type="checkbox"/> oFF Off (62) <input type="checkbox"/> oN On (63)		4684 [offset 80]	0x7F (127) 1 to 0x10 (16) 0x1C (28)	----	27028	uint R
<input type="checkbox"/> SuE [Su.E]	<i>Logic (1 to 16)</i> Source Value E View the value of Source E.	<input type="checkbox"/> oFF Off (62) <input type="checkbox"/> oN On (63)		4686 [offset 80]	0x7F (127) 1 to 0x10 (16) 0x1D (29)	----	27029	uint R
<input type="checkbox"/> SuF [Su.F]	<i>Logic (1 to 16)</i> Source Value F View the value of Source F.	<input type="checkbox"/> oFF Off (62) <input type="checkbox"/> oN On (63)		4688 [offset 80]	0x7F (127) 1 to 0x10 (16) 0x1E (30)	----	27030	uint R
<input type="checkbox"/> SuG [Su.g]	<i>Logic (1 to 16)</i> Value Source G View the value of Source G.	<input type="checkbox"/> oFF Off (62) <input type="checkbox"/> oN On (63)		4690 [offset 80]	0x7F (127) 1 to 0x10 (16) 0x1F (31)	----	27031	uint R
<input type="checkbox"/> SuH [Su.h]	<i>Logic (1 to 16)</i> Source Value H View the value of Source H.	<input type="checkbox"/> oFF Off (62) <input type="checkbox"/> oN On (63)		4692 [offset 80]	0x7F (127) 1 to 0x10 (16) 0x20 (32)	----	27032	uint R
<input type="checkbox"/> oV [o.v]	<i>Logic (1 to 16)</i> Output Value View the value of this function's output.	<input type="checkbox"/> oFF Off (62) <input type="checkbox"/> oN On (63)		4696 [offset 80]	0x7F (127) 1 to 0x10 (16) 0x22 (34)	----	27034	uint R
Note: Some values will be rounded off to fit in the four-character display. Full values can be read with other interfaces. If there is only one instance of a menu, no submenus will appear.								R: Read W: Write E: EEPROM S: User Set

Display	Parameter Name Description	Range	Default	Modbus Relative Address	CIP Class Instance Attribute hex (dec)	Profibus Index	Parameter ID	Data Type & Read/Write
No Display	<i>Logic (1 to 16)</i> Output Error View reported cause for logic error	None (61) Open (65) Shorted (127) Measurement Error (140) Bad Cal Data (139) Ambient Error (9) RTD Error (141) Fail (32) Math Error (1423) Not Sourced (246) Stale (1617)		4700 [offset 80]	0x7F (127) 1 to 0x10 (16) 0x24 (36)	----	27036	uint R
<div style="border: 1px solid black; padding: 2px;"> <input type="checkbox"/> OFF <input type="checkbox"/> PEr Math Menu </div>								
<input type="checkbox"/> SuA [Su.A]	<i>Math (1 to 16)</i> Source Value A View the value of Source A.	-1,999.000 to 9,999.000°F or units -1,128.000 to 5,537.000°C		3540 [offset 70]	0x7D (125) 1 to 0x10 (16) 0x10 (16)	----	25016	float RWES
<input type="checkbox"/> SuB [Su.b]	<i>Math (1 to 16)</i> Source Value B View the value of Source B.	-1,999.000 to 9,999.000°F or units -1,128.000 to 5,537.000°C		3542 [offset 70]	0x7D (125) 1 to 0x10 (16) 0x11 (17)	----	25017	float RWES
<input type="checkbox"/> SuC [Su.C]	<i>Math (1 to 16)</i> Source Value C View the value of Source C.	-1,999.000 to 9,999.000°F or units -1,128.000 to 5,537.000°C		3544 [offset 70]	0x7D (125) 1 to 0x10 (16) 0x12 (18)	----	25018	float RWES
<input type="checkbox"/> SuD [Su.d]	<i>Math (1 to 16)</i> Source Value D View the value of Source D.	-1,999.000 to 9,999.000°F or units -1,128.000 to 5,537.000°C		3546 [offset 70]	0x7D (125) 1 to 0x10 (16) 0x13 (19)	----	25019	float RWES
<input type="checkbox"/> SuE [Su.E]	<i>Math (1 to 16)</i> Source Value E View the value of Source E.	<input type="checkbox"/> OFF Off (62) <input type="checkbox"/> ON On (63)		3548 [offset 70]	0x7D (125) 1 to 0x10 (16) 0x14 (20)	----	25020	uint RWES
<input type="checkbox"/> oFSt [oFSt]	<i>Math (1 to 16)</i> Offset Set an offset to be applied to this function's output.	-1,999.000 to 9,999.000°F or units -1,128.000 to 5,537.000°C	0	3554 [offset 70]	0x7D (125) 1 to 0x10 (16) 0x17 (23)	----	25023	float RWES
<input type="checkbox"/> oV [o.v]	<i>Math (1 to 16)</i> Output Value View the value of this function's output.	-1,999.000 to 9,999.000°F or units -1,128.000 to 5,537.000°C		3552 [offset 70]	0x7D (125) 1 to 0x10 (16) 0x16 (22)	----	25022	float RWES
<p>Note: Some values will be rounded off to fit in the four-character display. Full values can be read with other interfaces.</p> <p>If there is only one instance of a menu, no submenus will appear.</p>								<p>R: Read W: Write E: EEPROM S: User Set</p>

Display	Parameter Name Description	Range	Default	Modbus Relative Address	CIP Class Instance Attribute hex (dec)	Profibus Index	Parameter ID	Data Type & Read/ Write
No Display	<i>Math (1 to 16)</i> Output Error View reported cause for logic error	None (61) Open (65) Shorted (127) Measurement Error (140) Bad Cal Data (139) Ambient Error (9) RTD Error (141) Fail (32) Math Error (1423) Not Sourced (246) Stale (1617)		3566 [offset 70]	0x7D (125) 1 to 0x10 (16) 0x1D (29)	- - - -	25029	uint R
<p>Note: Some values will be rounded off to fit in the four-character display. Full values can be read with other interfaces.</p> <p>If there is only one instance of a menu, no submenus will appear.</p>								R: Read W: Write E: EEPROM S: User Set

4

Chapter 4: Setup Pages

Navigating the Setup Page

To navigate to the Setup Page using the RUI, follow the steps below:

1. From the Home Page, press and hold both the Up ▲ and Down ▼ keys for six seconds. [R] will appear in the upper display and [SEE] will appear in the lower display.

Note:

If keys are released when [OPER] is displayed, press the Infinity Key ∞ or reset key to exit and repeat until [SEE] is displayed.

2. Press the Up ▲ or Down ▼ key to view available menus.
3. Press the Advance Key ⏩ to enter the menu of choice.

4. If a submenu exists (more than one instance), press the Up ▲ or Down ▼ key to select and then press the Advance Key ⏩ to enter.
5. Press the Up ▲ or Down ▼ key to move through available menu prompts.
6. Press the Infinity Key ∞ to move backwards through the levels: parameter to submenu; submenu to menu; menu to Home Page.
7. Press and hold the Infinity Key ∞ for two seconds to return to the Home Page.

On the following pages, top level menus are identified with a yellow background color.

Note:

Some of these menus and parameters may not appear, depending on the controller's options. See model number information in the Appendix for more information. If there is only one instance of a menu, no submenus will appear.

Note:

Some of the listed parameters may not be visible. Parameter visibility is dependent upon controller part number.

- [R]
- [SEE] Analog Input Menu
 - [1] to [12]
 - [R] Analog Input
 - [SEN] Sensor Type
 - [LIN] Linearization
 - [UNIT] Units
 - [SLO] Scale Low
 - [SHI] Scale High
 - [RLO] Range Low
 - [RHI] Range High
 - [PEE] Process Error Enable
 - [PEL] Process Error Low
 - [TCR] Thermistor Curve
 - [RR] Resistance Range
 - [FIL] Filter
 - [LER] Error Latching
 - [DEC] Display Precision
 - [CAL] Calibration Offset
 - [RIN] Process Value
 - [LER] Error Status
- [d IO]
- [SEE] Digital Input/Output Menu
 - [1] to [5] and [9]
 - [d IO] Digital Input/Output 1 (to 12)
 - [DIR] Direction
 - [FN] Function
 - [FI] Function Instance
 - [SZR] Source Zone A
 - [CTL] Control
 - [TBS] Time Base
 - [LPS] Low Power Scale

- [oh] High Power Scale
- [ACT]
- [SEE] Action Menu
 - [1] to [16]
 - [ACT] Action
 - [FN] Function
 - [FI] Function Instance
 - [SFNA] Source Function A
 - [SIA] Source Instance A
 - [SZR] Source Zone A
 - [LEV] Active Level
- [LPT]
- [SEE] Limit Menu
 - [1] to [12]
 - [LPT] Limit
 - [LSD] Sides
 - [LHY] Hysteresis
 - [SPLH] Set Point Limit High
 - [SPLL] Set Point Limit Low
 - [LHS] High Set Point
 - [LLS] Low Set Point
 - [SFNA] Source Function A
 - [SIA] Source Instance A
 - [SZR] Source Zone A
 - [CLR] Clear Request
 - [LSE] Status

- [oEP]
- [SEE] Output Menu
 - [1] to [10], [7] to [10]
 - [oEP] Output
 - [FN] Function
 - [FI] Function Instance
 - [SZR] Source Zone A
 - [CTL] Control
 - [TBS] Time Base
 - [LPS] Low Power Scale
 - [oh] High Power Scale
- [ALP]
- [SEE] Alarm Menu
 - [1] to [16]
 - [ALP] Alarm
 - [RLY] Type
 - [SFNA] Source Function A
 - [SIA] Source Instance A
 - [SZR] Source Zone A
 - [RHY] Hysteresis
 - [RL9] Logic
 - [RSD] Sides
 - [RLO] Low Set Point
 - [RHI] High Set Point
 - [RLA] Latching
 - [RBL] Blocking
 - [RS] Silencing
 - [RDSP] Display
 - [RDL] Delay
 - [RCLR] Clear Request
 - [RSR] Silence Request
 - [RSE] State

Lnr
SEE Linearization Menu
 1 to 16
Lnr Linearization
 Fn Function
 SFnA Source Function A
 S iA Source Instance A
 SZA Source Zone A
Units
 ,P,1 Input Point 1
 oP,1 Output Point 1
 ,P,2 Input Point 2
 oP,2 Output Point 2
 ,P,3 Input Point 3
 oP,3 Output Point 3
 ,P,4 Input Point 4
 oP,4 Output Point 4
 ,P,5 Input Point 5
 oP,5 Output Point 1
 ,P,6 Input Point 6
 oP,6 Output Point 6
 ,P,7 Input Point 7
 oP,7 Output Point 7
 ,P,8 Input Point 8
 oP,8 Output Point 8
 ,P,9 Input Point 9
 oP,9 Output Point 9
 ,P,10 Input Point 10
 oP,10 Output Point 10

CPE
SEE Compare Menu
 1 to 16
CPE Compare
 Fn Function
 Tol Tolerance
 SFnA Source Function A
 S iA Source Instance A
 SZA Source Zone A
 SFnB Source Function B
 S iB Source Instance B
 SZB Source Zone B
 Errh Error Handling

ETGr
SEE Timer Menu
 1 to 16
ETGr Timer
 Fn Function
 SFnA Source Function A
 S iA Source Instance A
 SZA Source Zone A
 SASA Source Active State A
 SFnB Source Function B
 S iB Source Instance B
 SZB Source Zone B
 SASB Source Active State B
 t, Time
 LEu Active Level

CEr
SEE Counter Menu
 1 to 16
CEr Counter 1 (to 4)
 Fn Function
 SFnA Source Function A
 S iA Source Instance A
 SZA Source Zone A
 SASA Source Active State A
 SFnB Source Function B
 S iB Source Instance B
 SZB Source Zone B
 SASB Source Active State B

LoAd Load Value
Er9E Target Value
LRtE Latching

L9C
SEE Logic Menu
 1 to 16
L9C Logic
 Fn Function
 SFnA Source Function A
 S iA Source Instance A
 SZA Source Zone A
 SFnB Source Function B
 S iB Source Instance B
 SZB Source Zone B
 SFnC Source Function C
 S iC Source Instance C
 SZC Source Zone C
 SFnD Source Function D
 S iD Source Instance D
 SZD Source Zone D
 SFnE Source Function E
 S iE Source Instance E
 SZE Source Zone E
 SFnF Source Function F
 S iF Source Instance F
 SZF Source Zone F
 SFnG Source Function G
 S iG Source Instance G
 SZG Source Zone G
 SFnH Source Function H
 S iH Source Instance H
 SZH Source Zone H
 Errh Error Handling

PTRE
SEE Math Menu
 1 to 16
PTRE Math
 Fn Function
 SFnA Source Function A
 S iA Source Instance A
 SZA Source Zone A
 SFnB Source Function B
 S iB Source Instance B
 SZB Source Zone B
 SFnC Source Function C
 S iC Source Instance C
 SZC Source Zone C
 SFnD Source Function D
 S iD Source Instance D
 SZD Source Zone D
 SFnE Source Function E
 S iE Source Instance E
 SZE Source Zone E
 SL0 Input Scale Low
 Sh, Input Scale High
 rLo Output Range Low
 rHi Output Range High
 Punt Pressure Units
 Runt Altitude Units
 Fil Filter

URr
SEE Variable Menu
 1 to 16
URr Variable
 TYPE Type
 Units Units
 d,9 Digital
 ANL9 Analog

GLbL
SEE Global Menu
 CF Display Units
 ACLK AC Line Frequency
 dPrS Display Pairs
 USrS User Save
 USrR User Restore

COM
SEE Communications Menu
 1
COM Communications
 bAUD Baud Rate
 PAR Parity
 P7hL Modbus Word Order
 CF Display Units
 nuS Non-volatile Save

Display	Parameter Name Description	Range	Default	Modbus Relative Address	CIP Class Instance Attribute hex (dec)	Profibus Index	Parameter ID	Data Type & Read/Write
<div style="border: 1px solid black; padding: 2px;"> <input type="checkbox"/> R <input type="checkbox"/> SEt Analog Input Menu </div>								
<input type="checkbox"/> SEn [SEn]	Analog Input (1 to 12) Sensor Type Set the analog sensor type to match the device wired to this input. Note: There is no open-sensor detection for process inputs.	<input type="checkbox"/> oFF Off (62) <input type="checkbox"/> TC Thermocouple (95) <input type="checkbox"/> mV Millivolts (56) <input type="checkbox"/> volt Volts dc (104) <input type="checkbox"/> mA Milliamps dc (112) <input type="checkbox"/> RTD 100 RTD 100 Ω (113) <input type="checkbox"/> RTD 1000 RTD 1,000 Ω (114) <input type="checkbox"/> Pot Potentiometer 1 kΩ (155) <input type="checkbox"/> ThEr Thermistor (229)		418 [offset 90]	0x68 (104) 1 to 0xC (12) 5	3	4005	uint RWES
<input type="checkbox"/> Lin [Lin]	Analog Input (1 to 12) Linearization Set the linearization to match the thermocouple wired to this input.	<input type="checkbox"/> B (11) <input type="checkbox"/> H K (48) <input type="checkbox"/> C (15) <input type="checkbox"/> N (58) <input type="checkbox"/> D (23) <input type="checkbox"/> R (80) <input type="checkbox"/> E (26) <input type="checkbox"/> S S (84) <input type="checkbox"/> F (30) <input type="checkbox"/> T T (93) <input type="checkbox"/> J (46)	J	420 [offset 90]	0x68 (104) 1 to 0xC (12) 6	4	4006	uint RWES
<input type="checkbox"/> Unit [Unit]	Analog Input (1 to 12) Units Set the type of units the sensor will measure.	<input type="checkbox"/> ATP Absolute Temperature (1540) <input type="checkbox"/> Power (73) <input type="checkbox"/> Pro Process (75) <input type="checkbox"/> rh Relative Humidity (1538)	Process	492 [offset 90]	0x68 (104) 1 to 0xC (12) 0x2A (42)	5	4042	uint RWES
<input type="checkbox"/> S.Lo [S.Lo]	Analog Input (1 to 12) Scale Low Set the low scale for process inputs. This value, in millivolts, volts or milliamps, will correspond to the Range Low output of this function block.	-100.0 to 1,000.0	0.0	438 [offset 90]	0x68 (104) 1 to 0xC (12) 0xF (15)	6	4015	float RWES
<input type="checkbox"/> S.hi [S.hi]	Analog Input (1 to 12) Scale High Set the high scale for process inputs. This value, in millivolts, volts or milliamps, will correspond to the Range High output of this function block.	-100.0 to 1,000.0	20.0	440 [offset 90]	0x68 (104) 1 to 0xC (12) 0x10 (16)	7	4016	float RWES
<input type="checkbox"/> r.Lo [r.Lo]	Analog Input (1 to 12) Range Low Set the low range for this function block's output.	-1,999.000 to 9,999.000	0.0	442 [offset 90]	0x68 (104) 1 to 0xC (12) 0x11 (17)	8	4017	float RWES
<input type="checkbox"/> r.hi [r.hi]	Analog Input (1 to 12) Range High Set the high range for this function block's output.	-1,999.000 to 9,999.000	9,999.0	444 [offset 90]	0x68 (104) 1 to 0xC (12) 0x12 (18)	9	4018	float RWES
<input type="checkbox"/> PEE [P.EE]	Analog Input (1 to 12) Process Error Enable Turn the Process Error Low feature on or off.	<input type="checkbox"/> oFF Off (62) <input type="checkbox"/> LoLJ Low (53)	Off	468 [offset 90]	0x68 (104) 1 to 0xC (12) 0x1E (30)	10	4030	uint RWES
Note: Some values will be rounded off to fit in the four-character display. Full values can be read with other interfaces. If there is only one instance of a menu, no submenus will appear.								R: Read W: Write E: EEPROM S: User Set

Display	Parameter Name Description	Range	Default	Modbus Relative Address	CIP Class Instance Attribute hex (dec)	Profibus Index	Parameter ID	Data Type & Read/ Write
PEL [P.EL]	<i>Analog Input (1 to 12)</i> Process Error Low If the process value drops below this value, it will trigger an input error.	-100.0 to 1,000.0	0.0	470 [offset 90]	0x68 (104) 1 to 0xC (12) 0x1F (31)	11	4031	float RWES
t.C [t.C]	<i>Analog Input (1 to 12)</i> Thermistor Curve Select a curve to apply to the thermistor input.	A Curve A (1451) b Curve B (1452) C Curve C (1453) USE Custom (180)	Curve A	484 [offset 90]	0x68 (104) 1 to 0xC (12) 0x26 (38)	----	4038	uint RWES
r.r [r.r]	<i>Analog Input (1 to 12)</i> Resistance Range Set the maximum resistance of the thermistor input.	5 5K (1448) 10 10K (1360) 20 20K (1361) 40 40K (1449)	40K	432 [offset 90]	0x68 (104) 1 to 0xC (12) 0x25 (37)	----	4037	uint RWES
F.iL [FiL]	<i>Analog Input (1 to 12)</i> Filter Filtering smooths out the process signal to both the display and the input. Increase the time to increase filtering.	0.0 to 60.0 seconds	0.5	386 [offset 90]	0x68 (104) 1 to 0xC (12) 0xE (14)	12	4014	float RWES
i.Er [i.Er]	<i>Analog Input (1 to 12)</i> Error Latching Turn input error latching on or off. If latching is on, errors must be manually cleared.	OFF Off (62) on On (63)	Off	414 [offset 90]	0x68 (104) 1 to 0xC (12) 0x1C (28)	----	4028	uint RWES
dEC [dEC]	<i>Analog Input (1 to 12)</i> Display Precision Set the precision of the displayed value.	0 Whole (105) 00 Tenths (94) 000 Hundredths (40) 0000 Thousandths (96)	Whole	398 [offset 90]	0x68 (104) 1 to 0xC (12) 0x14 (20)	----	4020	uint RWES
i.CA [i.CA]	<i>Analog Input (1 to 12)</i> Calibration Offset Offset the input reading to compensate for lead wire resistance or other factors that cause the input reading to vary from the actual process value.	-1,999.000 to 9,999.000°F or units -1,110.555 to 5,555.000°C	0.0	432 [offset 90]	0x68 (104) 1 to 0x10 (16) 0x0C (12)	----	4012	float RWES
A.in [Ain]	<i>Analog Input (1 to 12)</i> Process Value View the process value.	-1,999.000 to 9,999.000°F or units -1,128.000 to 5,537.000°C	----	410 [offset 90]	0x68 (104) 1 to 0xC (12) 1	0	4001	float RWES
i.Er [i.Er]	<i>Analog Input (1 to 12)</i> Error Status View the cause of the most recent error. If the REEn message is Er.i or Er.i2 , this parameter will display the cause of the input error.	none None (61) OPEN Open (65) SHrE Shorted (127) Er.M Measurement Error (149) Er.AL Bad Calibration Data (139) Er.Ab Ambient Error (9) Er.Ed RTD Error (141) FR.iL Fail (32) NSrC Not Sourced (246)	None	412 [offset 90]	0x68 (104) 1 to 0xC (12) 2	1	4002	float RWES
<p>Note: Some values will be rounded off to fit in the four-character display. Full values can be read with other interfaces.</p> <p>If there is only one instance of a menu, no submenus will appear.</p>								R: Read W: Write E: EEPROM S: User Set

Display	Parameter Name Description	Range	Default	Modbus Relative Address	CIP Class Instance Attribute hex (dec)	Profibus Index	Parameter ID	Data Type & Read/Write
<div style="border: 1px solid black; padding: 2px;"> d.i.o SET </div> Digital Input/Output Menu								
d.i.r [dir]	<i>Digital Input/Output (1 to 8)</i> Direction Set this function to operate as an input or output.	OPEE Output (68) .in Input Voltage (193) i.con Input Dry Contact (44)	Output	1850 [offset 30]	0x6A (106) 1 to 8 1	82	6001	uint RWES
d.i.r [dir]	<i>Digital Input (9)</i> Direction Set the input type.	.in Input Voltage (193) i.con Input Dry Contact (44)	Dry Contact	2090 [offset 30]	0x6A (106) 9 1	82	6001	uint RWES
Fn [Fn]	<i>Digital Output (1 to 6)</i> Function Select what function will drive this output.	OFF Off (62) ALPT Alarm (6) CPE Compare (230) CTR Counter (231) d.i.o Digital I/O (1142) FUN Function Key (1001) Lnr Linearization (238) L9C Logic (239) PTTE Math (240) ETTR Timer (244) uRR Variable (245) PQL Module Limit (1696) L.i.PT Limit (126)		1858 [offset 30]	0x 6A (106) 1 to 6 5	83	6005	uint RWES
Fi [Fi]	<i>Digital Output (1 to 8)</i> Function Instance Set the instance of the function selected above.	1 to 24	1	1860 [offset 30]	0x6A (106) 1 to 8 6	84	6006	uint RWES
SZ.A [SZ.A]	<i>Digital Output (1 to 8)</i> Source Zone A Set the zone of the function selected above.	0 to 16	0	1872 [offset 30]	0x6A (106) 1 to 8 0xC (12)	----	6012	uint RWES
o.Ct [o.Ct]	<i>Digital Output (1 to 8)</i> Control Set the output control type. This parameter is only used with PID control, but can be set anytime.	Ftb Fixed Time Base (34) vtb Variable Time Base (103)	Fixed Time Base	1852 [offset 30]	0x6A (106) 1 to 8 2	85	6002	uint RWES
o.tb [o.tb]	<i>Digital Output (1 to 8)</i> Time Base Set the time base for fixed-time-base control.	[0.1 for Fast and Bi-Directional outputs, 5.0 for Slow outputs] to 60		1854 [offset 30]	0x6A (106) 1 to 8 3	86	6003	float RWES
o.Lo [o.Lo]	<i>Digital Output (1 to 8)</i> Low Power Scale The power output will never be less than the value specified and will represent the value at which output scaling begins.	0.0 to 100.0	0.0	1866 [offset 30]	0x6A (106) 1 to 8 9	87	6009	float RWES
Note: Some values will be rounded off to fit in the four-character display. Full values can be read with other interfaces. If there is only one instance of a menu, no submenus will appear.								R: Read W: Write E: EEPROM S: User Set

Display	Parameter Name Description	Range	Default	Modbus Relative Address	CIP Class Instance Attribute hex (dec)	Profibus Index	Parameter ID	Data Type & Read/Write
<u>o.h</u> [o.hi]	<i>Digital Output (1 to 8)</i> High Power Scale The power output will never be greater than the value specified and will represent the value at which output scaling stops.	0.0 to 100.0	100.0	1868 [offset 30]	0x6A (106) 1 to 8 0xA (10)	88	6010	float RWES
<u>RCL</u> <u>SET</u> Action Menu								
<u>Fn</u> [Fn]	<i>Action (1 to 16)</i> Function Set the action that will be triggered by this function.	<u>none</u> None (61) <u>USR</u> User Settings Restore (227) <u>ALR</u> Alarm Reset (6) <u>SIL</u> Silence Alarms (108) <u>ROF</u> Control Loop Off and Alarms to Non-alarm State (220) <u>FAL</u> Force Alarm to Occur (218)	None	2214 [offset 20]	0x6E (110) 1 to 0x10 (16) 3	138	10003	uint RWES
<u>Fi</u> [Fi]	<i>Action (1 to 16)</i> Function Instance Set the instance of the function selected above.	0 to 25	0	2216 [offset 20]	0x6E (110) 1 to 0x10 (16) 4	139	10004	uint RWES
<u>SFn.A</u> [SFn.A]	<i>Action (1 to 16)</i> Source Function A Set the event or function that will trigger the action.	<u>none</u> None (61) <u>ALR</u> Alarm (6) <u>CPE</u> Compare (230) <u>CTR</u> Counter (231) <u>DIQ</u> Digital I/O (1142) <u>Ent.A</u> Profile Event Out A (233) <u>Ent.B</u> Profile Event Out B (234) <u>Ent.C</u> Profile Event Out C (235) <u>Ent.D</u> Profile Event Out D (236) <u>Ent.E</u> Profile Event Out E (247) <u>Ent.F</u> Profile Event Out F (248) <u>Ent.G</u> Profile Event Out G (249) <u>Ent.H</u> Profile Event Out H (250) <u>FUn</u> Function Key (1001) <u>LIM</u> Limit (126) <u>LOG</u> Logic (239) <u>TMR</u> Timer (244) <u>VAR</u> Variable (245)	None	2220 [offset 20]	0x6E (110) 1 to 0x10 (16) 6	----	10006	uint RWES
Note: Some values will be rounded off to fit in the four-character display. Full values can be read with other interfaces. If there is only one instance of a menu, no submenus will appear.								R: Read W: Write E: EEPROM S: User Set

Display	Parameter Name Description	Range	Default	Modbus Relative Address	CIP Class Instance Attribute hex (dec)	Profibus Index	Parameter ID	Data Type & Read/ Write
<input type="checkbox"/> S_iA [Si.A]	<i>Action (1 to 16)</i> Source Instance A Set the instance of the function selected above.	1 to 250	1	2212 [offset 20]	0x6E (110) 1 to 16 2	----	10002	uint RWES
<input type="checkbox"/> S_ZA [SZ.A]	<i>Action (1 to 16)</i> Source Zone A Set the zone of the function selected above.	0 to 16	0	2222 [offset 20]	0x6E (110) 1 to 16 7	----	10007	uint RWES
<input type="checkbox"/> LE_v [LEv]	<i>Action (1 to 16)</i> Active Level Set the action that will be considered a true state.	<input type="checkbox"/> LoL_v Low (53) <input type="checkbox"/> h_i9h High (37)	High	2230 [offset 20]	0x6E (110) 1 to 16 1	137	10001	uint RWES
<input type="checkbox"/> L_i?? <input type="checkbox"/> SE_t Limit Menu								
<input type="checkbox"/> L_Sd [L.Sd]	<i>Limit (1 to 12)</i> Sides Select which side or sides of the process value will be monitored.	<input type="checkbox"/> both Both (13) <input type="checkbox"/> h_i9h High (37) <input type="checkbox"/> LoL_v Low (53)	Both	1498 [offset 30]	0x70 (112) 1 to 12 5	40	12005	uint RWES
<input type="checkbox"/> L_hy [L.hy]	<i>Limit (1 to 12)</i> Hysteresis Set the hysteresis for the limit function. This determines how far into the safe range the process value must move before the limit can be cleared.	0.001 to 9,999.000°F or units 0.001 to 5,555.000°C	3.0°F or units 2.0°C	1492 [offset 30]	0x70 (112) 1 to 12 2	41	12002	float RWES
<input type="checkbox"/> S_PL_H [SP.Lh]	<i>Limit (1 to 12)</i> Set Point Limit High Set the high end of the limit set point range.	-1,999.000 to 9,999.000	9,999.000	1506 [offset 30]	0x70 (112) 1 to 12 9	39	12009	float RWES
<input type="checkbox"/> S_PL_L [SP.LL]	<i>Limit (1 to 12)</i> Set Point Limit Low Set the low end of the limit set point range.	-1,999.000 to 9,999.000	-1,999.000	1508 [offset 30]	0x70 (112) 1 to 12 0xA (10)	38	12010	float RWES
<input type="checkbox"/> L_hS [Lh.S]	<i>Limit (1 to 12)</i> High Set Point Set the high process value that will trigger the limit.	-1,999.000 to 9,999.000°F or units -1,128.000 to 5,537.000°C	0.0°F or units -18.0°C	1496 [offset 30]	0x70 (112) 1 to 12 4	42	12004	float RWES
<input type="checkbox"/> L_LS [LL.S]	<i>Limit (1 to 12)</i> Low Set Point Set the low process value that will trigger the limit.	-1,999.000 to 9,999.000°F or units -1,128.000 to 5,537.000°C	0.0°F or units -18.0°C	1494 [offset 30]	0x70 (112) 1 to 12 3	43	12003	float RWES
<input type="checkbox"/> S_Fn_A [SFn.A]	<i>Limit (1 to 12)</i> Source Function A Set the source for the limit reset function.	<input type="checkbox"/> nonE None (61) <input type="checkbox"/> d_io Digital I/O (1142) <input type="checkbox"/> F_Un Function Key (1001) <input type="checkbox"/> v_Ar Variable (245)	None	----	0x70 (112) 1 to 12 0x0F (15)	----	12015	uint RWES
<input type="checkbox"/> S_iA [Si.A]	<i>Limit (1 to 12)</i> Source Instance A Set the instance of the function selected above.	1 or 250	1	----	0x70 (112) 1 to 12 0x10 (16)	----	12016	uint RWES
Note: Some values will be rounded off to fit in the four-character display. Full values can be read with other interfaces. If there is only one instance of a menu, no submenus will appear.								R: Read W: Write E: EEPROM S: User Set

Display	Parameter Name Description	Range	Default	Modbus Relative Address	CIP Class Instance Attribute hex (dec)	Profibus Index	Parameter ID	Data Type & Read/Write
5ZP [SZ.A]	<i>Limit (1 to 12)</i> Source Zone A Set the zone of the function selected above.	0 or 16	0	----	0x70 (112) 1 to 0xC (12) 0x11 (17)	----	12017	uint RWES
LCr [LCr]	<i>Limit (1 to 12)</i> Limit Clear Clear the specified limit if limit condition no longer exists.	LCr Clear (129) Ignr Ignore (204)	Ignore	1516 [offset 30]	0x70 (112) 1 to 0xC (12) 0x0E (14)	----	12014	uint R
LSE [L.St]	<i>Limit (1 to 12)</i> Limit Status Current state of limit.	FRIL Fail (32) SAFE Safe (1667)	----	1500 [offset 30]	0x70 (112) 1 to 0xC (12) 6	----	12013	uint R
oPtE SEt Output Menu								
Fn [Fn]	<i>Output (1 to 4 and 7 - 10)</i> Function Select what function will drive this output. Note: Output 8 is set by default (factory settings) to module limit	oFF Off (62) ALPQ Alarm (6) CPE Compare (230) Ctr Counter (231) dIo Digital I/O (1142) Fun Function Key (1001) Lnr Linearization (238) L9C Logic (239) PTRE Math (240) TPQr Timer (244) vAr Variable (245) PTL Module Limit (1696) LrPQ Limit (126)	off	1858 [offset 30]	0x6A (106) 1 to 0xA (10) 5	96	6005	uint RWES
Fi [Fi]	<i>Output (1 to 4 and 7 - 10)</i> Function Instance Set the instance of the function selected above.	1 to 24	1	1860 [offset 30]	0x6A (106) 1 to 0xA (10) 6	----	6006	uint RWES
5ZP [SZ.A]	<i>Output (1 to 4 and 7 - 10)</i> Source Zone A Set the instance of the function selected above.	1 to 16	0	1872 [offset 30]	0x6A (106) 1 to 0xA (10) 0xC (12)	----	6012	uint RWES
oCt [o.Ct]	<i>Output (1 to 4 and 7 - 10)</i> Control Set the output control type. This parameter is only used with PID control, but can be set anytime.	Ftb Fixed Time Base (34) vtb Variable Time Base (103)	Fixed Time Base	1852 [offset 30]	0x6A (106) 1 to (12) 2	----	6002	uint RWES
oTb [o.tb]	<i>Output (1 to 4 and 7 - 10)</i> Time Base Set the time base for fixed-time-base control.	0.1 to 60.0 seconds (solid-state relay or switched dc) 5.0 to 60.0 seconds (mechanical relay or no-arc power control)	0.1 sec. [SSR & sw dc] 20.0 sec. [mech, relay, no-arc]	1854 [offset 30]	0x6A (106) 1 to (12) 3	----	6003	float RWES
Note: Some values will be rounded off to fit in the four-character display. Full values can be read with other interfaces. If there is only one instance of a menu, no submenus will appear.								R: Read W: Write E: EEPROM S: User Set

Display	Parameter Name Description	Range	Default	Modbus Relative Address	CIP Class Instance Attribute hex (dec)	Profibus Index	Parameter ID	Data Type & Read/ Write
<input type="checkbox"/> oLo [o.Lo]	<i>Output (1 to 4 and 7 - 10)</i> Low Power Scale The power output will never be less than the value specified and will represent the value at which output scaling begins.	0.0 to 100.0%	0.0%	1866 [offset 30]	0x6A (106) 1 to 10 9	----	6009	float RWES
<input type="checkbox"/> oHi [o.hi]	<i>Output (1 to 4 and 7 - 10)</i> High Power Scale The power output will never be greater than the value specified and will represent the value at which output scaling stops.	0.0 to 100.0%	100.0%	1868 [offset 30]	0x6A (106) 1 to 10 0xA (10)	----	6010	float RWES
<input type="checkbox"/> RLP? <input type="checkbox"/> SEE Alarm Menu								
<input type="checkbox"/> REY [A.ty]	<i>Alarm (1 to 16)</i> Type Select whether the alarm trigger is a fixed value or will track the set point.	<input type="checkbox"/> OFF Off (62) <input type="checkbox"/> PrAL Process Alarm (76)	Off	2558 [offset 60]	0x6D (109) 1 to 16 0xF (15)	20	9015	uint RWES
<input type="checkbox"/> SrA [Sr.A]	<i>Alarm (1 to 16)</i> Source Function A Select what will trigger this alarm.	<input type="checkbox"/> nonE None (61) <input type="checkbox"/> Ai Analog Input (142) <input type="checkbox"/> CUrr Current (22) <input type="checkbox"/> PLUJr Power, Control Loop (73) <input type="checkbox"/> Lnc Linearization (238) <input type="checkbox"/> PTRE Math (240) <input type="checkbox"/> Pv Process Value (241) <input type="checkbox"/> vAr Variable (245) <input type="checkbox"/> CUr Current Read (179)		2562 [offset 60]	0x6D (109) 1 to 4 0x11 (17)	21	9017	uint RWES
<input type="checkbox"/> iSA [iS.A]	<i>Alarm (1 to 16)</i> Source Instance A Set the instance of the function selected above.	1 or 250	1	2564 [offset 60]	0x6D (109) 1 to 16 0x12 (18)	22	9018	uint RWES
<input type="checkbox"/> SZA [SZ.A]	<i>Alarm (1 to 16)</i> Source Zone A Set the zone of the function selected above.	0 or 16	0	2578 [offset 60]	0x6D (109) 1 to 16 0x19 (25)	----	9025	uint RWES
<input type="checkbox"/> Ahy [A.hy]	<i>Alarm (1 to 16)</i> Hysteresis Set the hysteresis for an alarm. This determines how far into the safe region the process value needs to move before the alarm can be cleared.	0.001 to 9,999.000°F or units 0.001 to 5,555.000°C	1.0°F or units 1.0°C	2534 [offset 60]	0x6D (109) 1 to 16 3	24	9003	float RWES
<input type="checkbox"/> ALg [A.Lg]	<i>Alarm (1 to 16)</i> Logic Select what the output condition will be during the alarm state.	<input type="checkbox"/> ALC Close On Alarm (17) <input type="checkbox"/> ALO Open On Alarm (66)	Close On Alarm	2538 [offset 60]	0x6D (109) 1 to 0x10 (16) 5	25	9005	uint RWES
Note: Some values will be rounded off to fit in the four-character display. Full values can be read with other interfaces. If there is only one instance of a menu, no submenus will appear.								R: Read W: Write E: EEPROM S: User Set

RM Limit Module • Setup Page

Display	Parameter Name Description	Range	Default	Modbus Relative Address	CIP Class Instance Attribute hex (dec)	Profibus Index	Parameter ID	Data Type & Read/ Write
<input type="checkbox"/> R5d [A.Sd]	Alarm (1 to 16) Sides Select which side or sides will trigger this alarm.	<input type="checkbox"/> both Both (13) <input type="checkbox"/> h,9h High (37) <input type="checkbox"/> low Low (53)	Both	2536 [offset 60]	0x6D (109) 1 to 0x10 (16) 4	26	9004	uint RWES
<input type="checkbox"/> ALo [A.Lo]	Alarm (1 to 16) Low Set Point If Alarm Type (Setup Page, Alarm Menu) is set to: process - set the process value that will trigger a low alarm.	-1,999.000 to 9,999.000°F or units -1,128.000 to 5,537.000°C	32.0°F or units 0.0°C	----	----	----	----	----
<input type="checkbox"/> Ahi [A.hi]	Alarm (1 to 16) High Set Point If Alarm Type (Setup Page, Alarm Menu) is set to: process - set the process value that will trigger a high alarm.	-1,999.000 to 9,999.000°F or units -1,128.000 to 5,537.000°C	300.0°F or units 150.0°C	----	----	----	----	----
<input type="checkbox"/> ALA [A.LA]	Alarm (1 to 16) Latching Turn alarm latching on or off. A latched alarm has to be turned off by the user.	<input type="checkbox"/> non-Latching (60) <input type="checkbox"/> Latching (49)	Non-Latching	2542 [offset 60]	0x6D (109) 1 to 0x10 (16) 7	27	9007	uint RWES
<input type="checkbox"/> AbL [A.bL]	Alarm (1 to 16) Blocking Select when an alarm will be blocked. After startup and/or after the set point changes, the alarm will be blocked until the process value enters the normal range.	<input type="checkbox"/> off Off (62) <input type="checkbox"/> Start Startup (88) <input type="checkbox"/> SetPt Set Point (85) <input type="checkbox"/> both Both (13)	Off	2544 [offset 60]	0x6D (109) 1 to 0x10 (16) 8	28	9008	uint RWES
<input type="checkbox"/> ASi [A.Si]	Alarm (1 to 16) Silencing Turn alarm silencing on to allow the user to disable this alarm.	<input type="checkbox"/> off Off (62) <input type="checkbox"/> on On (63)	Off	2540 [offset 60]	0x6D (109) 1 to 0x10 (16) 6	29	9006	uint RWES
<input type="checkbox"/> AdSP [A.dSP]	Alarm (1 to 16) Display Display an alarm message when an alarm is active.	<input type="checkbox"/> off Off (62) <input type="checkbox"/> on On (63)	On	2560 [offset 60]	0x6D (109) 1 to 0x10 (16) 0x10 (16)	30	9016	uint RWES
<input type="checkbox"/> AdL [A.dL]	Alarm (1 to 16) Delay Set the span of time that the alarm will be delayed after the process value exceeds the alarm set point.	0 to 9,999 seconds	0	2570 [offset 60]	0x6D (109) 1 to 0x10 (16) 0x15 (21)	31	9021	uint RWES
<input type="checkbox"/> ALr [A.hi]	Alarm (1 to 16) Clear Request Write to this register to clear an alarm	Clear Ignore	Ignore	----	----	----	----	----
Note: Some values will be rounded off to fit in the four-character display. Full values can be read with other interfaces. If there is only one instance of a menu, no submenus will appear.								R: Read W: Write E: EEPROM S: User Set

Display	Parameter Name Description	Range	Default	Modbus Relative Address	CIP Class Instance Attribute hex (dec)	Profibus Index	Parameter ID	Data Type & Read/ Write
<input type="checkbox"/> RSir [A.Sir]	<i>Alarm (1 to 16)</i> Silence Request Write to this register to silence an alarm	Ignore Silence	Ignore	----	----	----	----	----
<input type="checkbox"/> RSE [A.St]	<i>Alarm (1 to 16)</i> State Current state of alarm	Startup None Blocked Alarm Low Alarm High Error	Startup	----	----	----	----	----
<input type="checkbox"/> Lnc <input type="checkbox"/> SEE Linearization Menu								
<input type="checkbox"/> Fn [Fn]	<i>Linearization (1 to 16)</i> Function Set how this function will linearize Source A.	<input type="checkbox"/> OFF Off (62) <input type="checkbox"/> STPd Stepped (1483) <input type="checkbox"/> Intc Interpolated (1482)	Off	7998 [offset 70]	0x86 (134) 1 to 16 5	----	34005	uint RWES
<input type="checkbox"/> SFnA [SFn.A]	<i>Linearization (1 to 16)</i> Source Function A Set the type of function that will be used for this source.	<input type="checkbox"/> nonE None (61) <input type="checkbox"/> VAR Variable (245) <input type="checkbox"/> SPo Set Point Open, Control Loop (243) <input type="checkbox"/> SPc Set Point Closed, Control Loop (242) <input type="checkbox"/> Pu Process Value (241) <input type="checkbox"/> MATh Math (240) <input type="checkbox"/> Lnc Linearization (238) <input type="checkbox"/> PuDr Power, Control Loop (73) <input type="checkbox"/> hPr Heat Power, Control Loop (160) <input type="checkbox"/> CPr Cool Power, Control Loop (161) <input type="checkbox"/> Cur Current (22) <input type="checkbox"/> AI Analog Input (142)	None	7990 [offset 70]	0x86 (134) 1 to 16 1	155	34001	uint RWES
<input type="checkbox"/> SiA [Si.A]	<i>Linearization (1 to 16)</i> Source Instance A Set the instance of the function selected above.	1 or 250	1	7992 [offset 70]	0x86 (134) 1 to 16 2	----	34002	uint RWES
<input type="checkbox"/> SZA [SZ.A]	<i>Linearization (1 to 16)</i> Source Zone A Set the zone of the function selected above.	0 or 16	0	7994 [offset 70]	0x86 (134) 1 to 16 3	----	34003	uint RWES
<input type="checkbox"/> Unit [Unit]	<i>Linearization (1 to 16)</i> Units Set the units of Source A.	<input type="checkbox"/> rh Relative Humidity (1538) <input type="checkbox"/> Pro Process (75) <input type="checkbox"/> PuDr Power (73) <input type="checkbox"/> rTP Relative Temperature (1541) <input type="checkbox"/> ATP Absolute Temperature (1540) <input type="checkbox"/> nonE None (61) <input type="checkbox"/> Src Source (1539)	Source	8046 [offset 70]	0x86 (134) 1 to 16 0x1D (29)	156	34029	uint RWES
<p>Note: Some values will be rounded off to fit in the four-character display. Full values can be read with other interfaces.</p> <p>If there is only one instance of a menu, no submenus will appear.</p>								R: Read W: Write E: EEPROM S: User Set

Display	Parameter Name Description	Range	Default	Modbus Relative Address	CIP Class Instance Attribute hex (dec)	Profibus Index	Parameter ID	Data Type & Read/ Write
<input type="checkbox"/> P.1 [ip.1]	<i>Linearization (1 to 16)</i> Input Point 1 Set the value that will be mapped to output 1.	-1,999.000 to 9,999.000	0.0	8004 [offset 70]	0x86 (134) 1 to 0x10 (16) 8	157	34008	float RWES
<input type="checkbox"/> oP.1 [op.1]	<i>Linearization (1 to 16)</i> Output Point 1 Set the value that will be mapped to input 1.	-1,999.000 to 9,999.000	0.0	8024 [offset 70]	0x86 (134) 1 to 0x10 (16) 0x12 (18)	158	34018	float RWES
<input type="checkbox"/> P.2 [ip.2]	<i>Linearization (1 to 16)</i> Input Point 2 Set the value that will be mapped to output 2.	-1,999.000 to 9,999.000	1.0	8006 [offset 70]	0x86 (134) 1 to 0x10 (16) 9	159	34009	float RWES
<input type="checkbox"/> oP.2 [op.2]	<i>Linearization (1 to 16)</i> Output Point 2 Set the value that will be mapped to input 2.	-1,999.000 to 9,999.000	1.0	8026 [offset 70]	0x86 (134) 1 to 0x10 (16) 0x13 (19)	160	34019	float RWES
<input type="checkbox"/> P.3 [ip.3]	<i>Linearization (1 to 16)</i> Input Point 3 Set the value that will be mapped to output 3.	-1,999.000 to 9,999.000	2.0	8008 [offset 70]	0x86 (134) 1 to 0x10 (16) 0xA (10)	161	34010	float RWES
<input type="checkbox"/> oP.3 [op.3]	<i>Linearization (1 to 16)</i> Output Point 3 Set the value that will be mapped to input 3.	-1,999.000 to 9,999.000	2.0	8028 [offset 70]	0x86 (134) 1 to 0x10 (16) 0x14 (20)	162	34020	float RWES
<input type="checkbox"/> P.4 [ip.4]	<i>Linearization (1 to 16)</i> Input Point 4 Set the value that will be mapped to output 4.	-1,999.000 to 9,999.000	3.0	8010 [offset 70]	0x86 (134) 1 to 0x10 (16) 0xB (11)	163	34011	float RWES
<input type="checkbox"/> oP.4 [op.4]	<i>Linearization (1 to 16)</i> Output Point 4 Set the value that will be mapped to input 4.	-1,999.000 to 9,999.000	3.0	8030 [offset 70]	0x86 (134) 1 to 0x10 (16) 0x15 (21)	164	34021	float RWES
<input type="checkbox"/> P.5 [ip.5]	<i>Linearization (1 to 16)</i> Input Point 5 Set the value that will be mapped to output 5.	-1,999.000 to 9,999.000	4.0	8012 [offset 70]	0x86 (134) 1 to 0x10 (16) 0xC (12)	165	34012	float RWES
<input type="checkbox"/> oP.5 [op.5]	<i>Linearization (1 to 16)</i> Output Point 5 Set the value that will be mapped to input 5.	-1,999.000 to 9,999.000	4.0	8032 [offset 70]	0x86 (134) 1 to 0x10 (16) 0x16 (22)	166	34022	float RWES
<input type="checkbox"/> P.6 [ip.6]	<i>Linearization (1 to 16)</i> Input Point 6 Set the value that will be mapped to output 6.	-1,999.000 to 9,999.000	5.0	8014 [offset 70]	0x86 (134) 1 to 0x10 (16) 0xD (13)	167	34013	float RWES
<input type="checkbox"/> oP.6 [op.6]	<i>Linearization (1 to 16)</i> Output Point 6 Set the value that will be mapped to input 6.	-1,999.000 to 9,999.000	5.0	8034 [offset 70]	0x86 (134) 1 to 0x10 (16) 0x17 (23)	168	34023	float RWES
<input type="checkbox"/> P.7 [ip.7]	<i>Linearization (1 to 16)</i> Input Point 7 Set the value that will be mapped to output 7.	-1,999.000 to 9,999.000	6.0	8016 [offset 70]	0x86 (134) 1 to 0x10 (16) E (14)	169	34014	float RWES
<p>Note: Some values will be rounded off to fit in the four-character display. Full values can be read with other interfaces.</p> <p>If there is only one instance of a menu, no submenus will appear.</p>								R: Read W: Write E: EEPROM S: User Set

Display	Parameter Name Description	Range	Default	Modbus Relative Address	CIP Class Instance Attribute hex (dec)	Profibus Index	Parameter ID	Data Type & Read/ Write
<input type="checkbox"/> oP.7 [op.7]	<i>Linearization (1 to 16)</i> Output Point 7 Set the value that will be mapped to input 7.	-1,999.000 to 9,999.000	6.0	8036 [offset 70]	0x86 (134) 1 to 0x10 (16) 0x18 (24)	170	34024	float RWES
<input type="checkbox"/> ,P.8 [ip.8]	<i>Linearization (1 to 16)</i> Input Point 8 Set the value that will be mapped to output 8.	-1,999.000 to 9,999.000	7.0	8018 [offset 70]	0x86 (134) 1 to 0x10 (16) 0xF (15)	171	34015	float RWES
<input type="checkbox"/> oP.8 [op.8]	<i>Linearization (1 to 16)</i> Output Point 8 Set the value that will be mapped to input 8.	-1,999.000 to 9,999.000	7.0	8038 [offset 70]	0x86 (134) 1 to 0x10 (16) 0x19 (25)	172	34025	float RWES
<input type="checkbox"/> ,P.9 [ip.9]	<i>Linearization (1 to 16)</i> Input Point 9 Set the value that will be mapped to output 9.	-1,999.000 to 9,999.000	8.0	8020 [offset 70]	0x86 (134) 1 to 0x10 (16) 0x10 (16)	173	34016	float RWES
<input type="checkbox"/> oP.9 [op.9]	<i>Linearization (1 to 16)</i> Output Point 9 Set the value that will be mapped to input 9.	-1,999.000 to 9,999.000	8.0	8040 [offset 70]	0x86 (134) 1 to 0x10 (16) 0x1A (26)	174	34026	float RWES
<input type="checkbox"/> ,P.10 [ip.10]	<i>Linearization (1 to 16)</i> Input Point 10 Set the value that will be mapped to output 10.	-1,999.000 to 9,999.000	9.0	8022 [offset 70]	0x86 (134) 1 to 0x10 (16) 0x11 (17)	175	34017	float RWES
<input type="checkbox"/> oP.10 [op.10]	<i>Linearization (1 to 16)</i> Output Point 10 Set the value that will be mapped to input 10.	-1,999.000 to 9,999.000	9.0	8042 [offset 70]	0x86 (134) 1 to 0x10 (16) 0x1B (27)	176	34027	float RWES
<input type="checkbox"/> CPE <input type="checkbox"/> SET Compare Menu								
<input type="checkbox"/> Fn [Fn]	<i>Compare (1 to 16)</i> Function Set operator that will be used to compare Source A to Source B.	<input type="checkbox"/> OFF Off (62) <input type="checkbox"/> LoE Less or Equal (1440) <input type="checkbox"/> GoE Greater or Equal (1439) <input type="checkbox"/> nE Not Equal To (1438) <input type="checkbox"/> E Equal To (1437) <input type="checkbox"/> LT Less Than (1436) <input type="checkbox"/> GT Greater Than (1435)	Off	5926 [offset 40]	0x80 (128) 1 to 0x10 (16) 9	223	28009	uint RWES
<input type="checkbox"/> tol [toL]	<i>Compare (1 to 16)</i> Tolerance If the difference between Source A and Source B is less than this value the two will appear to be equal.	0 to 9,999.000	0.1	5930 [offset 40]	0x80 (128) 1 to 0x10 (16) 0xB (11)	230	28011	float RWES
Note: Some values will be rounded off to fit in the four-character display. Full values can be read with other interfaces. If there is only one instance of a menu, no submenus will appear.								R: Read W: Write E: EEPROM S: User Set

Display	Parameter Name Description	Range	Default	Modbus Relative Address	CIP Class Instance Attribute hex (dec)	Profibus Index	Parameter ID	Data Type & Read/Write
SFn.A [SFn.A]	<i>Compare (1 to 16)</i> Source Function A Set the type of function that will be used for this source.	none None (61) A Analog Input (142) Cur Current (22) CP Cool Power, Control Loop (161) hP Heat Power, Control Loop (160) Pwr Power, Control Loop (73) Lnr Linearization (238) Math Math (240) PV Process Value (241) SPC Set Point Closed, Control Loop (242) SPO Set Point Open, Control Loop (243) Var Variable (245)	None	5910 [offset 40]	0x80 (128) 1 to 16 1	----	28001	uint RWES
S.i.A [Si.A]	<i>Compare (1 to 16)</i> Source Instance A Set the instance of the function selected above.	1 to 250	1	5914 [offset 40]	0x80 (128) 1 to 16 3	----	28003	uint RWES
SZ.A [SZ.A]	<i>Compare (1 to 16)</i> Source Zone A Set the zone of the function selected above.	0 to 16	0	5918 [offset 40]	0x80 (128) 1 to 16 5	----	28005	uint RWES
SFn.b [SFn.b]	<i>Compare (1 to 16)</i> Source Function B Set the type of function that will be used for this source.	none None (61) A Analog Input (142) Cur Current (22) CP Cool Power, Control Loop (161) hP Heat Power, Control Loop (160) Pwr Power, Control Loop (73) Lnr Linearization (238) Math Math (240) PV Process Value (241) SPC Set Point Closed, Control Loop (242) SPO Set Point Open, Control Loop (243) Var Variable (245)	None	5912 [offset 40]	0x80 (128) 1 to 16 2	----	28002	uint RWES
S.i.b [Si.b]	<i>Compare (1 to 16)</i> Source Instance B Set the instance of the function selected above.	1 to 250	1	5916 [offset 40]	0x80 (128) 1 to 16 4	----	28004	uint RWES
SZ.b [SZ.b]	<i>Compare (1 to 16)</i> Source Zone B Set the zone of the function selected above.	0 to 16	0	5920 [offset 40]	0x80 (128) 1 to 16 6	----	28006	uint RWES
Er.h [Er.h]	<i>Compare (1 to 16)</i> Error Handling	T.G True Good (1476) T.B True Bad (1477) F.G False Good (1478) F.B False Bad (1479)	False Bad	5932 [offset 40]	0x80 (128) 1 to 16 0xC (12)	----	28012	uint RWES
<p>Note: Some values will be rounded off to fit in the four-character display. Full values can be read with other interfaces.</p> <p>If there is only one instance of a menu, no submenus will appear.</p>								R: Read W: Write E: EEPROM S: User Set

Display	Parameter Name Description	Range	Default	Modbus Relative Address	CIP Class Instance Attribute hex (dec)	Profibus Index	Parameter ID	Data Type & Read/Write
<div style="border: 1px solid black; padding: 2px;"> E P P r S E E Timer Menu </div>								
<div style="border: 1px solid black; padding: 2px;"> F n [Fn] </div>	Timer (1 to 16) Function Set how the timer will function.	o F F Off (62) o n P On Pulse (1471) d E L Delay (1472) o S One Shot (1473) r E t Retentive (1474)	Off	7206 [offset 50]	0x83 (131) 1 to 16 9	223	31009	uint RWES
<div style="border: 1px solid black; padding: 2px;"> S F n A [SFn.A] </div>	Timer (1 to 16) Source Function A Set the type of function that will be used for this source (run signal).	n o n E None (61) A L P r Alarm Reset (6) C P E Compare (230) C t r Counter (231) d i o Digital I/O (1142) E n t A Profile Event Out A (233) E n t B Profile Event Out B (234) E n t C Profile Event Out C (235) E n t D Profile Event Out D (236) E n t E Profile Event Out E (247) E n t F Profile Event Out F (248) E n t G Profile Event Out G (249) E n t H Profile Event Out H (250) F U n Function Key (1001) L G C Logic (239) S o F . 1 Special Function Output 1 (1532) S o F . 2 Special Function Output 2 (1533) S o F . 3 Special Function Output 3 (1534) S o F . 4 Special Function Output 4 (1535) E P P r Timer (244) v A r Variable (245)	None	7190 [offset 50]	0x83 (131) 1 to 16 1	----	31001	uint RWES
<div style="border: 1px solid black; padding: 2px;"> S i A [Si.A] </div>	Timer (1 to 4) Source Instance A Set the instance of the function selected above.	1 to 250	1	7194 [offset 50]	0x83 (131) 1 to 16 3	----	31003	uint RWES
<div style="border: 1px solid black; padding: 2px;"> S Z A [SZ.A] </div>	Timer (1 to 4) Source Zone A Set the zone of the function selected above.	0 to 16	0	7198 [offset 50]	0x83 (131) 1 to 16 5	----	31005	uint RWES
<div style="border: 1px solid black; padding: 2px;"> S A S A [SAS.A] </div>	Timer (1 to 4) Source Active State A Set what state will be read as on.	h i g h High (37) L o w Low (53)	High	7210 [offset 50]	0x83 (131) 1 to 16 0xB (11)	----	31011	uint RWES
Note: Some values will be rounded off to fit in the four-character display. Full values can be read with other interfaces. If there is only one instance of a menu, no submenus will appear.								R: Read W: Write E: EEPROM S: User Set

Display	Parameter Name Description	Range	Default	Modbus Relative Address	CIP Class Instance Attribute hex (dec)	Profibus Index	Parameter ID	Data Type & Read/ Write
SFn.b [SFn.b]	<i>Timer (1 to 16)</i> Source Function B Set the type of function that will be used to reset a retentive timer (reset signal).	none None (61) ALRN Alarm Reset (6) CPE Compare (230) CTR Counter (231) diO Digital I/O (1142) Ent.A Profile Event Out A (233) Ent.B Profile Event Out B (234) Ent.C Profile Event Out C (235) Ent.D Profile Event Out D (236) Ent.E Profile Event Out E (247) Ent.F Profile Event Out F (248) Ent.G Profile Event Out G (249) Ent.H Profile Event Out H (250) Fun Function Key (1001) LOG Logic (239) Sof.1 Special Function Output 1 (1532) Sof.2 Special Function Output 2 (1533) Sof.3 Special Function Output 3 (1534) Sof.4 Special Function Output 4 (1535) TRR Timer (244) Var Variable (245)	None	7192 [offset 50]	0x83 (131) 1 to 16 2	----	31002	uint RWES
Si.b [Si.b]	<i>Timer (1 to 16)</i> Source Instance B Set the instance of the function selected above.	1 to 250	1	7196 [offset 50]	0x83 (131) 1 to 16 4	----	31004	uint RWES
SZ.b [SZ.b]	<i>Timer (1 to 16)</i> Source Zone B Set the zone of the function selected above.	0 to 16	0	7200 [offset 50]	0x83 (131) 1 to 16 6	----	31006	uint RWES
SAS.b [SAS.b]	<i>Timer (1 to 16)</i> Source Active State B Set what state will be read as on.	High (37) Low (53)	High	7212 [offset 50]	0x83 (131) 1 to 4 0xC (12)	----	31012	uint RWES
ti [ti]	<i>Timer (1 to 16)</i> Time Set the time span that will be measured.	0 to 9,999.000	1.0	7214 [offset 50]	0x83 (131) 1 to 16 0xD (13)	224	31013	float RWES
LEv [LEv]	<i>Timer (1 to 16)</i> Active Level Set which output state will indicate on.	High (37) Low (53)	High	7216 [offset 50]	0x83 (131) 1 to 16 0xE (14)	----	31014	uint RWES
<p>Note: Some values will be rounded off to fit in the four-character display. Full values can be read with other interfaces.</p> <p>If there is only one instance of a menu, no submenus will appear.</p>								R: Read W: Write E: EEPROM S: User Set

RM Limit Module • Setup Page

Display	Parameter Name Description	Range	Default	Modbus Relative Address	CIP Class Instance Attribute hex (dec)	Profibus Index	Parameter ID	Data Type & Read/ Write
<input type="checkbox"/> Clr <input type="checkbox"/> Set Counter Menu								
<input type="checkbox"/> Fn [Fn]	<i>Counter (1 to 16)</i> Function Set whether the counter increments or decrements the count value. Decrementing 0 returns 9,999. Incrementing 9,999 returns 0.	<input type="checkbox"/> UP Up (1456) <input type="checkbox"/> dn Down (1457)	Up	6566 [offset 40]	0x82 (130) 1 to 16 9	----	30009	uint RWES
<input type="checkbox"/> SFnA [SFn.A]	<i>Counter (1 to 16)</i> Source Function A Set the type of function that will be used for the counter clock signal.	<input type="checkbox"/> none None (61) <input type="checkbox"/> ALPr Alarm Reset (6) <input type="checkbox"/> CPE Compare (230) <input type="checkbox"/> Clr Counter (231) <input type="checkbox"/> dio Digital I/O (1142) <input type="checkbox"/> EntA Profile Event Out A (233) <input type="checkbox"/> EntB Profile Event Out B (234) <input type="checkbox"/> EntC Profile Event Out C (235) <input type="checkbox"/> EntD Profile Event Out D (236) <input type="checkbox"/> EntE Profile Event Out E (247) <input type="checkbox"/> EntF Profile Event Out F (248) <input type="checkbox"/> EntG Profile Event Out G (249) <input type="checkbox"/> EntH Profile Event Out H (250) <input type="checkbox"/> FUn Function Key (1001) <input type="checkbox"/> LG Logic (239) <input type="checkbox"/> TPTr Timer (244) <input type="checkbox"/> vAr Variable (245)	None	6550 [offset 40]	0x82 (130) 1 to 16 1	----	30001	uint RWES
<input type="checkbox"/> SiA [Si.A]	<i>Counter (1 to 16)</i> Source Instance A Set the instance of the function selected above.	1 to 250	1	6554 [offset 40]	0x82 (130) 1 to 16 3	----	30003	uint RWES
<input type="checkbox"/> SZA [SZ.A]	<i>Counter (1 to 16)</i> Source Zone A Set the zone of the function selected above.	0 to 16	0	6558 [offset 40]	0x82 (130) 1 to 16 5	----	30005	uint RWES
<input type="checkbox"/> SASA [SAS.A]	<i>Counter (1 to 16)</i> Source Active State A Set what output state will indicate on.	<input type="checkbox"/> hi High (37) <input type="checkbox"/> low Low (53) <input type="checkbox"/> both Both (130)	High	6570 [offset 40]	0x82 (130) 1 to 16 0xB (11)	----	30011	uint RWES
Note: Some values will be rounded off to fit in the four-character display. Full values can be read with other interfaces. If there is only one instance of a menu, no submenus will appear.								R: Read W: Write E: EEPROM S: User Set

Display	Parameter Name Description	Range	Default	Modbus Relative Address	CIP Class Instance Attribute hex (dec)	Profibus Index	Parameter ID	Data Type & Read/ Write
SFn.b [SFn.b]	<i>Counter (1 to 16)</i> Source Function B Set the type of function that will be used for the counter load signal.	none None (61) ALRN Alarm Reset (6) CPE Compare (230) CTr Counter (231) dIo Digital I/O (1142) EntA Profile Event Out A (233) EntB Profile Event Out B (234) EntC Profile Event Out C (235) EntD Profile Event Out D (236) EntE Profile Event Out E (247) EntF Profile Event Out F (248) EntG Profile Event Out G (249) EntH Profile Event Out H (250) FUn Function Key (1001) LG Logic (239) Trn Timer (244) vAr Variable (245)	None	6552 [offset 40]	0x82 (130) 1 to 16 2	----	30002	uint RWES
Si.b [Si.b]	<i>Counter (1 to 16)</i> Source Instance B Set the instance of the function selected above.	1 to 250	1	6556 [offset 40]	0x82 (130) 1 to 16 4	----	30004	uint RWES
SZ.b [SZ.b]	<i>Counter (1 to 16)</i> Source Zone B Set the zone of the function selected above.	0 to 16	0	6560 [offset 40]	0x82 (130) 1 to 16 6	----	30006	uint RWES
SAS.b [SAS.b]	<i>Counter (1 to 16)</i> Source Active State B Set what output state will indicate on.	High (37) Low (53)	High	6572 [offset 40]	0x82 (130) 1 to 16 0xC (12)	----	30012	uint RWES
LoAd [LoAd]	<i>Counter (1 to 16)</i> Load Value Set the counter's initial value.	0 to 9,999	0	6574 [offset 40]	0x82 (130) 1 to 16 (13)	215	30013	uint RWES
Trgt [trgt]	<i>Counter (1 to 16)</i> Target Value Set the value that will turn the output value on.	0 to 9,999	9,999	6576 [offset 40]	0x82 (130) 1 to 16 0xE (14)	216	30014	uint RWES
LA [LAT]	<i>Counter (1 to 16)</i> Latching If enabled, output will latch when count equals target value.	No (59) Yes (106)	No	6582 [offset 40]	0x82 (130) 1 to 16 0x11 (17)	218	30017	uint RWES
<p>Note: Some values will be rounded off to fit in the four-character display. Full values can be read with other interfaces.</p> <p>If there is only one instance of a menu, no submenus will appear.</p>								R: Read W: Write E: EEPROM S: User Set

RM Limit Module • Setup Page

Display	Parameter Name Description	Range	Default	Modbus Relative Address	CIP Class Instance Attribute hex (dec)	Profibus Index	Parameter ID	Data Type & Read/Write
<input type="checkbox"/> L9C <input type="checkbox"/> SEt Logic Menu								
<input type="checkbox"/> Fn [Fn]	Logic (1 to 16) Function Set the operator that will be used to compare the sources.	<input type="checkbox"/> oFF Off (62) <input type="checkbox"/> And (1426) <input type="checkbox"/> nAnd (1427) <input type="checkbox"/> or (1442) <input type="checkbox"/> nor (1443) <input type="checkbox"/> E Equal To (1437) <input type="checkbox"/> nE Not Equal To (1438) <input type="checkbox"/> LAt Latch (1444) <input type="checkbox"/> rSFF Flip-Flop (1693)	Off	4694 [offset 80]	0x7F (127) 1 to 16 0x21 (33)	235	27033	uint RWES
<input type="checkbox"/> SFnA [SFn.A]	Logic (1 to 16) Source Function A Set the type of function that will be used for this source.	<input type="checkbox"/> nonE None (61) <input type="checkbox"/> ALr Alarm Reset (6) <input type="checkbox"/> CPE Compare (230) <input type="checkbox"/> Ctr Counter (231) <input type="checkbox"/> dio Digital I/O (1142) <input type="checkbox"/> EntA Profile Event Out A (233) <input type="checkbox"/> EntB Profile Event Out B (234) <input type="checkbox"/> EntC Profile Event Out C (235) <input type="checkbox"/> EntD Profile Event Out D (236) <input type="checkbox"/> EntE Profile Event Out E (247) <input type="checkbox"/> EntF Profile Event Out F (248) <input type="checkbox"/> EntG Profile Event Out G (249) <input type="checkbox"/> EntH Profile Event Out H (250) <input type="checkbox"/> FUN Function Key (1001) <input type="checkbox"/> Lim Limit (126) <input type="checkbox"/> L9C Logic (239) <input type="checkbox"/> SOf.1 Special Function Output 1 (1532) <input type="checkbox"/> SOf.2 Special Function Output 2 (1533) <input type="checkbox"/> SOf.3 Special Function Output 3 (1534) <input type="checkbox"/> SOf.4 Special Function Output 4 (1535) <input type="checkbox"/> ETn Timer (244) <input type="checkbox"/> vAr Variable (245)	None	4630 [offset 80]	0x7F (127) 1 to 16 1	----	27001	uint RWES
<input type="checkbox"/> SiA [Si.A]	Logic (1 to 16) Source Instance A Set the instance of the function selected above.	1 to 250	1	4646 [offset 80]	0x7F (127) 1 to 16 9	----	27009	uint RWES
Note: Some values will be rounded off to fit in the four-character display. Full values can be read with other interfaces. If there is only one instance of a menu, no submenus will appear.								R: Read W: Write E: EEPROM S: User Set

Display	Parameter Name Description	Range	Default	Modbus Relative Address	CIP Class Instance Attribute hex (dec)	Profibus Index	Parameter ID	Data Type & Read/ Write
<input type="checkbox"/> SZ.A [SZ.A]	<i>Logic (1 to 16)</i> Source Zone A Set the zone of the function selected above.	0 to 16	0	4662 [offset 80]	0x7F (127) 1 to 16 0x11 (17)	----	27017	uint RWES
<input type="checkbox"/> SFn.b [SFn.b]	<i>Logic (1 to 16)</i> Source B Function Set the type of function that will be used for this source.	<input type="checkbox"/> None (61) <input type="checkbox"/> Alarm Reset (6) <input type="checkbox"/> Compare (230) <input type="checkbox"/> Counter (231) <input type="checkbox"/> Digital I/O (1142) <input type="checkbox"/> Profile Event Out A (233) <input type="checkbox"/> Profile Event Out B (234) <input type="checkbox"/> Profile Event Out C (235) <input type="checkbox"/> Profile Event Out D (236) <input type="checkbox"/> Profile Event Out E (247) <input type="checkbox"/> Profile Event Out F (248) <input type="checkbox"/> Profile Event Out G (249) <input type="checkbox"/> Profile Event Out H (250) <input type="checkbox"/> Function Key (1001) <input type="checkbox"/> Limit (126) <input type="checkbox"/> Logic (239) <input type="checkbox"/> Special Function Output 1 (1532) <input type="checkbox"/> Special Function Output 2 (1533) <input type="checkbox"/> Special Function Output 3 (1534) <input type="checkbox"/> Special Function Output 4 (1535) <input type="checkbox"/> Timer (244) <input type="checkbox"/> Variable (245))	None	4632 [offset 80]	0x7F (127) 1 to 16 2	----	27002	uint RWES
<input type="checkbox"/> Si.b [Si.b]	<i>Logic (1 to 16)</i> Source Instance B Set the instance of the function selected above.	1 to 250	1	4648 [offset 80]	0x7F (127) 1 to 16 0xA (10)	----	27010	uint RWES
<input type="checkbox"/> SZ.b [SZ.b]	<i>Logic (1 to 16)</i> Source Zone B Set the zone of the function selected above	0 to 16	0	4664 [offset 80]	0x7F (127) 1 to 16 0x12 (18)	----	27018	uint RWES
<p>Note: Some values will be rounded off to fit in the four-character display. Full values can be read with other interfaces.</p> <p>If there is only one instance of a menu, no submenus will appear.</p>								R: Read W: Write E: EEPROM S: User Set

Display	Parameter Name Description	Range	Default	Modbus Relative Address	CIP Class Instance Attribute hex (dec)	Profibus Index	Parameter ID	Data Type & Read/ Write
SFn.C [SFn.C]	<i>Logic (1 to 16)</i> Source Function C Set the type of function that will be used for this source.	<input type="checkbox"/> None (61) <input type="checkbox"/> ALRN Alarm Reset (6) <input type="checkbox"/> CPE Compare (230) <input type="checkbox"/> CTR Counter (231) <input type="checkbox"/> DIQ Digital I/O (1142) <input type="checkbox"/> EntA Profile Event Out A (233) <input type="checkbox"/> EntB Profile Event Out B (234) <input type="checkbox"/> EntC Profile Event Out C (235) <input type="checkbox"/> EntD Profile Event Out D (236) <input type="checkbox"/> EntE Profile Event Out E (247) <input type="checkbox"/> EntF Profile Event Out F (248) <input type="checkbox"/> EntG Profile Event Out G (249) <input type="checkbox"/> EntH Profile Event Out H (250) <input type="checkbox"/> FUn Function Key (1001) <input type="checkbox"/> LIM Limit (126) <input type="checkbox"/> LOG Logic (239) <input type="checkbox"/> Sof.1 Special Function Output 1 (1532) <input type="checkbox"/> Sof.2 Special Function Output 2 (1533) <input type="checkbox"/> Sof.3 Special Function Output 3 (1534) <input type="checkbox"/> Sof.4 Special Function Output 4 (1535) <input type="checkbox"/> TPTr Timer (244) <input type="checkbox"/> VAR Variable (245)	None	4634 [offset 80]	0x7F (127) 1 to 16 3	----	27003	uint RWES
<input type="checkbox"/> Su.C [Si.C]	<i>Logic (1 to 16)</i> Source Instance C Set the instance of the function selected above.	1 to 250	1	4650 [offset 80]	0x7F (127) 1 to 16 0xB (11)	----	27011	uint RWES
<input type="checkbox"/> SZ.C [SZ.C]	<i>Logic (1 to 16)</i> Source Zone C Set the zone of the function selected above.	0 to 16	0	4666 [offset 80]	0x7F (127) 1 to 16 0x13 (19)	----	27019	uint RWES
<p>Note: Some values will be rounded off to fit in the four-character display. Full values can be read with other interfaces.</p> <p>If there is only one instance of a menu, no submenus will appear.</p>								R: Read W: Write E: EEPROM S: User Set

Display	Parameter Name Description	Range	Default	Modbus Relative Address	CIP Class Instance Attribute hex (dec)	Profibus Index	Parameter ID	Data Type & Read/ Write
SFn.d [SFn.d]	<i>Logic (1 to 16)</i> Source Function D Set the type of function that will be used for this source.	<input type="checkbox"/> None None (61) <input type="checkbox"/> ALR Alarm Reset (6) <input type="checkbox"/> CPE Compare (230) <input type="checkbox"/> CTR Counter (231) <input type="checkbox"/> DIQ Digital I/O (1142) <input type="checkbox"/> Ent.A Profile Event Out A (233) <input type="checkbox"/> Ent.B Profile Event Out B (234) <input type="checkbox"/> Ent.C Profile Event Out C (235) <input type="checkbox"/> Ent.D Profile Event Out D (236) <input type="checkbox"/> Ent.E Profile Event Out E (247) <input type="checkbox"/> Ent.F Profile Event Out F (248) <input type="checkbox"/> Ent.G Profile Event Out G (249) <input type="checkbox"/> Ent.H Profile Event Out H (250) <input type="checkbox"/> FUN Function Key (1001) <input type="checkbox"/> LIM Limit (126) <input type="checkbox"/> LOG Logic (239) <input type="checkbox"/> Sof.1 Special Function Output 1 (1532) <input type="checkbox"/> Sof.2 Special Function Output 2 (1533) <input type="checkbox"/> Sof.3 Special Function Output 3 (1534) <input type="checkbox"/> Sof.4 Special Function Output 4 (1535) <input type="checkbox"/> TMR Timer (244) <input type="checkbox"/> VAR Variable (245))	None	4636 [offset 80]	0x7F (127) 1 to 16 4	----	27004	uint RWES
<input type="checkbox"/> Si.d [Si.d]	<i>Logic (1 to 16)</i> Source Instance D Set the instance of the function selected above.	1 to 250	1	4652 [offset 80]	0x7F (127) 1 to 16 0xC (12)	----	27012	uint RWES
<input type="checkbox"/> SZ.d [SZ.d]	<i>Logic (1 to 16)</i> Source Zone D Set the zone of the function selected above.	0 to 16	0	4668 [offset 80]	0x7F (127) 1 to 16 0x14 (20)	----	27020	uint RWES
<p>Note: Some values will be rounded off to fit in the four-character display. Full values can be read with other interfaces.</p> <p>If there is only one instance of a menu, no submenus will appear.</p>								R: Read W: Write E: EEPROM S: User Set

Display	Parameter Name Description	Range	Default	Modbus Relative Address	CIP Class Instance Attribute hex (dec)	Profibus Index	Parameter ID	Data Type & Read/ Write
SFnE [SFn.E]	<i>Logic (1 to 16)</i> Source Function E Set the type of function that will be used for this source.	<input type="checkbox"/> None (61) <input type="checkbox"/> ALRn Alarm Reset (6) <input type="checkbox"/> CPE Compare (230) <input type="checkbox"/> CTR Counter (231) <input type="checkbox"/> DIo Digital I/O (1142) <input type="checkbox"/> EntA Profile Event Out A (233) <input type="checkbox"/> EntB Profile Event Out B (234) <input type="checkbox"/> EntC Profile Event Out C (235) <input type="checkbox"/> EntD Profile Event Out D (236) <input type="checkbox"/> EntE Profile Event Out E (247) <input type="checkbox"/> EntF Profile Event Out F (248) <input type="checkbox"/> EntG Profile Event Out G (249) <input type="checkbox"/> EntH Profile Event Out H (250) <input type="checkbox"/> FUn Function Key (1001) <input type="checkbox"/> LIn Limit (126) <input type="checkbox"/> LG Logic (239) <input type="checkbox"/> Sof.1 Special Function Output 1 (1532) <input type="checkbox"/> Sof.2 Special Function Output 2 (1533) <input type="checkbox"/> Sof.3 Special Function Output 3 (1534) <input type="checkbox"/> Sof.4 Special Function Output 4 (1535) <input type="checkbox"/> TPTr Timer (244) <input type="checkbox"/> UR Variable (245)	None	4638 [offset 80]	0x7F (127) 1 to 16 5	----	27005	uint RWES
<input type="checkbox"/> SiE [Si.E]	<i>Logic (1 to 16)</i> Source Instance E Set the instance of the function selected above.	1 to 250	1	4654 [offset 80]	0x7F (127) 1 to 16 D (13)	----	27013	uint RWES
<input type="checkbox"/> SZE [SZ.E]	<i>Logic (1 to 16)</i> Source Zone E Set the zone of the function selected above.	0 to 16	0	4670 [offset 80]	0x7F (127) 1 to 16 0x15 (21)	----	27021	uint RWES
<p>Note: Some values will be rounded off to fit in the four-character display. Full values can be read with other interfaces.</p> <p>If there is only one instance of a menu, no submenus will appear.</p>								R: Read W: Write E: EEPROM S: User Set

Display	Parameter Name Description	Range	Default	Modbus Relative Address	CIP Class Instance Attribute hex (dec)	Profibus Index	Parameter ID	Data Type & Read/ Write
SFn.F [SFn.F]	<i>Logic (1 to 16)</i> Source Function F Set the type of function that will be used for this source.	None (61) ALRN Alarm Reset (6) CPE Compare (230) CTR Counter (231) dio Digital I/O (1142) Ent.A Profile Event Out A (233) Ent.B Profile Event Out B (234) Ent.C Profile Event Out C (235) Ent.D Profile Event Out D (236) Ent.E Profile Event Out E (247) Ent.F Profile Event Out F (248) Ent.G Profile Event Out G (249) Ent.H Profile Event Out H (250) FUN Function Key (1001) LIM Limit (126) LOG Logic (239) Sof.1 Special Function Output 1 (1532) Sof.2 Special Function Output 2 (1533) Sof.3 Special Function Output 3 (1534) Sof.4 Special Function Output 4 (1535) TRR Timer (244) VAR Variable (245))	None	4640 [offset 80]	0x7F (127) 1 to 16 6	----	27006	uint RWES
Si.F [Si.F]	<i>Logic (1 to 16)</i> Source Instance F Set the instance of the function selected above.	1 to 250	1	4656 [offset 80]	0x7F (127) 1 to 16 0xE (14)	----	27014	uint RWES
SZF [SF.F]	<i>Logic (1 to 16)</i> Source Zone F Set the zone of the function selected above.	0 to 16	0	4672 [offset 80]	0x7F (127) 1 to 16 0x16 (22)	----	27022	uint RWES
<p>Note: Some values will be rounded off to fit in the four-character display. Full values can be read with other interfaces.</p> <p>If there is only one instance of a menu, no submenus will appear.</p>								R: Read W: Write E: EEPROM S: User Set

Display	Parameter Name Description	Range	Default	Modbus Relative Address	CIP Class Instance Attribute hex (dec)	Profibus Index	Parameter ID	Data Type & Read/ Write
SFn.g [SFn.g]	<i>Logic (1 to 16)</i> Source Function G Set the type of function that will be used for this source.	<input type="checkbox"/> None (61) <input type="checkbox"/> Alarm Reset (6) <input type="checkbox"/> Compare (230) <input type="checkbox"/> Counter (231) <input type="checkbox"/> Digital I/O (1142) <input type="checkbox"/> Profile Event Out A (233) <input type="checkbox"/> Profile Event Out B (234) <input type="checkbox"/> Profile Event Out C (235) <input type="checkbox"/> Profile Event Out D (236) <input type="checkbox"/> Profile Event Out E (247) <input type="checkbox"/> Profile Event Out F (248) <input type="checkbox"/> Profile Event Out G (249) <input type="checkbox"/> Profile Event Out H (250) <input type="checkbox"/> Function Key (1001) <input type="checkbox"/> Limit (126) <input type="checkbox"/> Logic (239) <input type="checkbox"/> Special Function Output 1 (1532) <input type="checkbox"/> Special Function Output 2 (1533) <input type="checkbox"/> Special Function Output 3 (1534) <input type="checkbox"/> Special Function Output 4 (1535) <input type="checkbox"/> Timer (244) <input type="checkbox"/> Variable (245)	None	4642 [offset 80]	0x7F (127) 1 to 16 7	----	27007	uint RWES
S.g [Si.g]	<i>Logic (1 to 16)</i> Source Instance G Set the instance of the function selected above.	1 to 250	1	4658 [offset 80]	0x7F (127) 1 to 16 0xF (15)	----	27015	uint RWES
SZ.g [SZ.g]	<i>Logic (1 to 16)</i> Source Zone G Set the zone of the function selected above.	0 to 16	0	4674 [offset 80]	0x7F (127) 1 to 16 0x17 (23)	----	27023	uint RWES
<p>Note: Some values will be rounded off to fit in the four-character display. Full values can be read with other interfaces.</p> <p>If there is only one instance of a menu, no submenus will appear.</p>								R: Read W: Write E: EEPROM S: User Set

Display	Parameter Name Description	Range	Default	Modbus Relative Address	CIP Class Instance Attribute hex (dec)	Profibus Index	Parameter ID	Data Type & Read/ Write
SFn.h [SFn.h]	<i>Logic (1 to 16)</i> Source Function H Set the type of function that will be used for this source.	<input type="checkbox"/> None (61) <input type="checkbox"/> Alarm Reset (6) <input type="checkbox"/> Compare (230) <input type="checkbox"/> Counter (231) <input type="checkbox"/> Digital I/O (1142) <input type="checkbox"/> Profile Event Out A (233) <input type="checkbox"/> Profile Event Out B (234) <input type="checkbox"/> Profile Event Out C (235) <input type="checkbox"/> Profile Event Out D (236) <input type="checkbox"/> Profile Event Out E (247) <input type="checkbox"/> Profile Event Out F (248) <input type="checkbox"/> Profile Event Out G (249) <input type="checkbox"/> Profile Event Out H (250) <input type="checkbox"/> Function Key (1001) <input type="checkbox"/> Limit (126) <input type="checkbox"/> Logic (239) <input type="checkbox"/> Special Function Output 1 (1532) <input type="checkbox"/> Special Function Output 2 (1533) <input type="checkbox"/> Special Function Output 3 (1534) <input type="checkbox"/> Special Function Output 4 (1535) <input type="checkbox"/> Timer (244) <input type="checkbox"/> Variable (245))	None	4644 [offset 80]	0x7F (127) 1 to 16 8	----	27008	uint RWES
Si.h [Si.h]	<i>Logic (1 to 16)</i> Source Instance H Set the instance of the function selected above.	1 to 250	1	4660 [offset 80]	0x7F (127) 1 to 16 0x10 (16)	----	27016	uint RWES
SZ.h [SZ.h]	<i>Logic (1 to 16)</i> Source Zone H Set the zone of the function selected above.	0 to 16	0	4676 [offset 80]	0x7F (127) 1 to 16 0x18 (24)	----	27024	uint RWES
Er.h [Er.h]	<i>Logic (1 to 16)</i> Error Handling	<input type="checkbox"/> True Good (1476) <input type="checkbox"/> True Bad (1477) <input type="checkbox"/> False Good (1478) <input type="checkbox"/> False Bad (1479)	False Bad	4698 [offset 80]	0x7F (127) 1 to 16 0x23 (35)	----	27035	uint RWES
<p>Note: Some values will be rounded off to fit in the four-character display. Full values can be read with other interfaces.</p> <p>If there is only one instance of a menu, no submenus will appear.</p>								<p>R: Read W: Write E: EEPROM S: User Set</p>

Display	Parameter Name Description	Range	Default	Modbus Relative Address	CIP Class Instance Attribute hex (dec)	Profibus Index	Parameter ID	Data Type & Read/Write
Math Menu <input type="checkbox"/> Fn [Fn]								
<input type="checkbox"/> Fn [Fn]	Math (1 to 16) Function Set the operator that will be applied to the sources.	<input type="checkbox"/> OFF Off (62) <input type="checkbox"/> Avg Average (1367) <input type="checkbox"/> PSC Process Scale (1371) <input type="checkbox"/> dSC Deviation Scale (1372) <input type="checkbox"/> So Switch Over (1370) <input type="checkbox"/> d,FF Differential (1373) <input type="checkbox"/> rAt Ratio (1374) <input type="checkbox"/> Add Add (1375) <input type="checkbox"/> MUL Multiply (1376) <input type="checkbox"/> Ad, F Absolute Difference (1377) <input type="checkbox"/> Min Minimum (1378) <input type="checkbox"/> MAX Maximum (1379) <input type="checkbox"/> root Square Root (1380) <input type="checkbox"/> hold Sample and Hold (1381) <input type="checkbox"/> Alt Altitude (1349) <input type="checkbox"/> dELU Dewpoint (1650)	Off	3550 [offset 70]	0x7D (125) 1 to 16 0x15 (21)	128	25021	uint RWES
<input type="checkbox"/> SFnA [SFn.A]	Math (1 to 16) Source Function A Set the type of function that will be used for this source.	<input type="checkbox"/> none None (61) <input type="checkbox"/> A Analog Input (142) <input type="checkbox"/> Cur Current (22) <input type="checkbox"/> CP Cool Power, Control Loop (161) <input type="checkbox"/> hP Heat Power, Control Loop (160) <input type="checkbox"/> PLU Power, Control Loop (73) <input type="checkbox"/> Lin Linearization (238) <input type="checkbox"/> Math Math (240) <input type="checkbox"/> PV Process Value (241) <input type="checkbox"/> SPC Set Point Closed, Control Loop (242) <input type="checkbox"/> SPo Set Point Open, Control Loop (243) <input type="checkbox"/> VAR Variable (245)	None	3510 [offset 70]	0x7D (125) 1 to 16 1	----	25001	uint RWES
<input type="checkbox"/> SiA [Si.A]	Math (1 to 16) Source Instance A Set the instance of the function selected above.	1 to 250	1	3520 [offset 70]	0x7D (125) 1 to 16 6	----	25006	uint RWES
<input type="checkbox"/> SZA [SZ.A]	Math (1 to 16) Source Zone A Set the zone of the function selected above.	0 to 16	0	3530 [offset 70]	0x7D (125) 1 to 16 0xB (11)	----	25011	uint RWES
Note: Some values will be rounded off to fit in the four-character display. Full values can be read with other interfaces. If there is only one instance of a menu, no submenus will appear.								R: Read W: Write E: EEPROM S: User Set

Display	Parameter Name Description	Range	Default	Modbus Relative Address	CIP Class Instance Attribute hex (dec)	Profibus Index	Parameter ID	Data Type & Read/ Write
5Fn.b [SFn.b]	<i>Math (1 to 16)</i> Source Function B Set the type of function that will be used for this source.	none None (61) A Analog Input (142) Curr Current (22) CP Cool Power, Control Loop (161) hP Heat Power, Control Loop (160) PL Power, Control Loop (73) Lnr Linearization (238) MATH Math (240) PV Process Value (241) SPC Set Point Closed, Control Loop (242) SPO Set Point Open, Control Loop (243) VAR Variable (245)	None	3512 [offset 70]	0x7D (125) 1 to 16 2	----	25002	uint RWES
5.b [Si.b]	<i>Math (1 to 16)</i> Source Instance B Set the instance of the function selected above.	1 to 250	1	3522 [offset 70]	0x7D (125) 1 to 16 7	----	25007	uint RWES
5Zb [SZ.b]	<i>Math (1 to 16)</i> Source Zone B Set the zone of the function selected above.	0 to 16	0	3532 [offset 70]	0x7D (125) 1 to 16 0xC (12)	----	25012	uint RWES
5Fn.C [SFn.C]	<i>Math (1 to 16)</i> Source Function C Set the type of function that will be used for this source.	none None (61) A Analog Input (142) Curr Current (22) CP Cool Power, Control Loop (161) hP Heat Power, Control Loop (160) PL Power, Control Loop (73) Lnr Linearization (238) MATH Math (240) PV Process Value (241) SPC Set Point Closed, Control Loop (242) SPO Set Point Open, Control Loop (243) VAR Variable (245)	None	3514 [offset 70]	0x7D (125) 1 to 16 3	----	25003	uint RWES
5.C [Si.C]	<i>Math (1 to 16)</i> Source Instance C Set the instance of the function selected above.	1 to 250	1	3524 [offset 70]	0x7D (125) 1 to 16 8	----	25008	uint RWES
5ZC [SZ.C]	<i>Math (1 to 16)</i> Source Zone C Set the zone of the function selected above.	0 to 16	0	3534 [offset 70]	0x7D (125) 1 to 16 0xD (13)	----	25013	uint RWES
<p>Note: Some values will be rounded off to fit in the four-character display. Full values can be read with other interfaces.</p> <p>If there is only one instance of a menu, no submenus will appear.</p>								R: Read W: Write E: EEPROM S: User Set

Display	Parameter Name Description	Range	Default	Modbus Relative Address	CIP Class Instance Attribute hex (dec)	Profibus Index	Parameter ID	Data Type & Read/ Write
[SF.n.d] [SF.n.d]	<i>Math (1 to 16)</i> Source Function D Set the type of function that will be used for this source.	<input type="checkbox"/> none None (61) <input type="checkbox"/> A Analog Input (142) <input type="checkbox"/> Curr Current (22) <input type="checkbox"/> CP Cool Power, Control Loop (161) <input type="checkbox"/> hP Heat Power, Control Loop (160) <input type="checkbox"/> Pwr Power, Control Loop (73) <input type="checkbox"/> Lnr Linearization (238) <input type="checkbox"/> MATH Math (240) <input type="checkbox"/> PV Process Value (241) <input type="checkbox"/> SPC Set Point Closed, Control Loop (242) <input type="checkbox"/> SPO Set Point Open, Control Loop (243) <input type="checkbox"/> VAR Variable (245)	None	3516 [offset 70]	0x7D (125) 1 to 16 4	----	25004	uint RWES
[S.i.d] [Si.d]	<i>Math (1 to 16)</i> Source Instance D Set the instance of the function selected above.	1 to 250	1	3526 [offset 70]	0x7D (125) 1 to 16 9	----	25009	uint RWES
[SZ.d] [SZ.d]	<i>Math (1 to 16)</i> Source Zone D Set the zone of the function selected above.	0 to 16	0	3536 [offset 70]	0x7D (125) 1 to 16 0xE (14)	----	25014	uint RWES
[SF.n.E] [SF.n.E]	<i>Math (1 to 16)</i> Source Function E Set the type of function that will be used for this source.	<input type="checkbox"/> none None (61) <input type="checkbox"/> ALRM Alarm Reset (6) <input type="checkbox"/> CPE Compare (230) <input type="checkbox"/> CTR Counter (231) <input type="checkbox"/> dio Digital I/O (1142) <input type="checkbox"/> EntA Profile Event Out A (233) <input type="checkbox"/> EntB Profile Event Out B (234) <input type="checkbox"/> EntC Profile Event Out C (235) <input type="checkbox"/> EntD Profile Event Out D (236) <input type="checkbox"/> EntE Profile Event Out E (247) <input type="checkbox"/> EntF Profile Event Out F (248) <input type="checkbox"/> EntG Profile Event Out G (249) <input type="checkbox"/> EntH Profile Event Out H (250) <input type="checkbox"/> FUN Function Key (1001) <input type="checkbox"/> LGC Logic (239) <input type="checkbox"/> TMR Timer (244) <input type="checkbox"/> VAR Variable (245)	None	3518 [offset 70]	0x7D (125) 1 to 16 5	----	25005	uint RWES
[S.i.E] [Si.E]	<i>Math (1 to 16)</i> Source Instance E Set the instance of the function selected above.	1 to 250	1	3528 [offset 70]	0x7D (125) 1 to 16 0xA (10)	----	25010	uint RWES
<p>Note: Some values will be rounded off to fit in the four-character display. Full values can be read with other interfaces.</p> <p>If there is only one instance of a menu, no submenus will appear.</p>								R: Read W: Write E: EEPROM S: User Set

Display	Parameter Name Description	Range	Default	Modbus Relative Address	CIP Class Instance Attribute hex (dec)	Profibus Index	Parameter ID	Data Type & Read/ Write
SZE [SZ.E]	<i>Math (1 to 16)</i> Source Zone E Set the zone of the function selected above.	0 to 16	0	3538 [offset 70]	0x7D (125) 1 to 16 0xF (15)	----	25015	uint RWES
SLo [S.Lo]	<i>Math (1 to 16)</i> Input Scale Low This value will correspond to Output Range Low.	-1,999.000 to 9,999.000	0.0	3556 [offset 70]	0x7D (125) 1 to 16 0x18 (24)	129	25024	float RWES
S.h [S.hi]	<i>Math (1 to 16)</i> Input Scale High This value will correspond to Output Range High.	-1,999.000 to 9,999.000	1.0	3558 [offset 70]	0x7D (125) 1 to 16 0x19 (25)	130	25025	float RWES
r.Lo [r.Lo]	<i>Math (1 to 16)</i> Output Range Low This value will correspond to Input Scale Low.	-1,999.000 to 9,999.000	0.0	3560 [offset 70]	0x7D (125) 1 to 16 0x1A (26)	131	25026	float RWES
r.h [r.hi]	<i>Math (1 to 16)</i> Output Range High This value will correspond to Input Scale High.	-1,999.000 to 9,999.000	1.0	3562 [offset 70]	0x7D (125) 1 to 16 0x1B (27)	132	25027	float RWES
P.unt [P.unt]	<i>Math (1 to 16)</i> Pressure Units	PS Pressure Units (1671) mbr mbar (1672) Torr Torr (1673) PASC Pascal (1674) ATM Atmosphere (1675)	Pressure Units	3568 [offset 70]	0x7D (125) 1 to 16 0x1E (30)	----	25030	uint RWES
A.unt [A.unt]	<i>Math (1 to 16)</i> Altitude Units	FE Feet (1674) HFE Kilofeet (1671)	Kilofeet	3570 [offset 70]	0x7D (125) 1 to 16 0x1F (31)	----	25031	uint RWES
FIL [FiL]	<i>Math (1 to 16)</i> Filter Filtering smooths out the output signal of this function block. Increase the time to increase filtering.	0.0 to 60.0 seconds	0.0	3564 [offset 70]	0x7D (125) 1 to 16 0x1C (28)	----	25028	float RWES
uAr SEt Variable Menu								
tyPE [tyPE]	<i>Variable (1 to 16)</i> Data Type Set the variable's data type.	ANL Analog (1215) d Digital (1220)	Analog	9110 [offset 20]	0x66 (102) 1 to 16 1	210	2001	uint RWES
Unit [Unit]	<i>Variable (1 to 16)</i> Units Set the variable's units.	ATP Absolute Temperature (1540) rTP Relative Temperature (1541) PLU Power (73) Pro Process (75) rh Relative Humidity (1538) none None (61)	Absolute Temper- ature	9122 [offset 20]	0x66 (102) 1 to 16 7	----	2007	uint RWES
Note: Some values will be rounded off to fit in the four-character display. Full values can be read with other interfaces. If there is only one instance of a menu, no submenus will appear.								R: Read W: Write E: EEPROM S: User Set

Display	Parameter Name Description	Range	Default	Modbus Relative Address	CIP Class Instance Attribute hex (dec)	Profibus Index	Parameter ID	Data Type & Read/ Write
<u>d.9</u> [dig]	<i>Variable (1 to 16)</i> Digital Set the variable's value.	<u>oFF</u> Off (62) <u>on</u> On (63)	Off	9112 [offset 20]	0x66 (102) 1 to 0x10 (16) 2	211	2002	uint RWES
<u>RnL9</u> [AnLg]	<i>Variable (1 to 16)</i> Analog Set the variable's value.	-1,999.000 to 9,999.000 Note: Stored in °F only	0.0	9114 [offset 20]	0x66 (102) 1 to 0x10 (16) 3	212	2003	float RWES
No Dis- play	<i>Variable (1 to 16)</i> Output Value	Off (62) On (63) -1,999.000 to 9,999.000	----	9116 [offset 20]	0x66 (102) 1 to 0x10 (16) 4	----	2004	float R
<u>9LbL</u> <u>SEE</u> Global Menu								
<u>C.F</u> [C.F]	<i>Global</i> Display Units Select which scale to use for temperature.	<u>F</u> °F (30) <u>C</u> °C (15)	°F	368	0x67 (103) 1 5	110	3005	uint RWES
<u>ACLF</u> [AC.LF]	<i>Global</i> AC Line Frequency Set the frequency to the ap- plied ac line power source.	<u>50</u> 50 Hz (3) <u>60</u> 60 Hz (4)	60 Hz	----	0x65 (101) 1 0x22 (34)	----	1034	uint RWES
<u>dPrS</u> [dPrS]	<i>Global</i> Display Pairs Defines the number of Dis- play Pairs.	1 to 15	2	----	0x67 (103) 1 0x1C (28)	----	3028	uint RWES
<u>USrS</u> [USr.S]	<i>Global</i> User Settings Save Save all of this controller's settings to the selected set.	<u>none</u> None (61)- <u>SEE1</u> User Set 1 (101) <u>SEE2</u> User Set 2 (102)	None	26	0x65 (101) 1 0x0E (14)	118	1014	uint RWE
<u>USr.r</u> [USr.r]	<i>Global</i> User Restore Settings Replace all of this control- ler's settings with another set.	<u>none</u> None (61) <u>SEE1</u> User Set 1 (101) <u>SEE2</u> User Set 2 (102) <u>FLCY</u> Factory (31)	None	24	0x65 (101) 1 0x0D (13)	117	1013	uint RWE
<u>COP</u> <u>SEE</u> Communications Menu								
<u>bAUd</u> [bAUd]	<i>Communications</i> Baud Rate Set the speed of this con- troller's communications to match the speed of the serial network.	9,600 (188) 19,200 (189) 38,400 (190)	9,600	3494	0x96 (150) 1 3	----	17002	uint RWE
<u>PAR</u> [PAR]	<i>Communications</i> Parity Set the parity of this con- troller to match the parity of the serial network.	<u>none</u> None (61) <u>Even</u> Even (191) <u>odd</u> Odd (192)	None	3496	0x96 (150) 1 4	----	17003	uint RWE
Note: Some values will be rounded off to fit in the four-character display. Full values can be read with other interfaces. If there is only one instance of a menu, no submenus will appear.								R: Read W: Write E: EEPROM S: User Set













Display	Parameter Name Description	Range	Default	Modbus Relative Address	CIP Class Instance Attribute hex (dec)	Profibus Index	Parameter ID	Data Type & Read/ Write
<input checked="" type="checkbox"/> hL [M.hL]	<i>Communications</i> Modbus Word Order Select the word order of the two 16-bit words in the floating-point values.	<input checked="" type="checkbox"/> hL Word High Low (1330) <input type="checkbox"/> LoH Word Low High (1331)	Low High	3498	0x96 (150) 1 5	----	17043	uint RWE
<input type="checkbox"/> C_F [C_F]	<i>Communications</i> Comm Units Select which scale to use for temperature over comms.	°F (30) °C (15)	°F	3500	0x96 (150) 1 6	----	17050	uint RWE
<input checked="" type="checkbox"/> nVS [nV.S]	<i>Communications (1)</i> Non-volatile Save If set to Yes all values written to the control will be saved in EEPROM. Note: Any value that is changed from the RUI or over a communications port will initiate a write to the EEPROM. Life of EEPROM is approximately one million writes.	<input checked="" type="checkbox"/> YES Yes (106) <input type="checkbox"/> no No (59)	Yes	3504	0x96 (150) 1 8	198	17051	uint RWE
Note: Some values will be rounded off to fit in the four-character display. Full values can be read with other interfaces. If there is only one instance of a menu, no submenus will appear.								R: Read W: Write E: EEPROM S: User Set

5

Chapter 5: Factory Pages

Navigating the Factory Page

To navigate to the Factory Page using the RUI, follow the steps below:

1. From the Home Page, press and hold both the Advance  and Infinity  keys for six seconds.
2. Press the Up  or Down  key to view available menus.
3. Press the Advance Key  to enter the menu of choice.
4. If a submenu exists (more than one instance), press the Up  or Down  key to select and then press the Advance Key  to enter.
5. Press the Up  or Down  key to move through available menu prompts.
6. Press the Infinity Key  to move backwards through the levels: parameter to submenu; submenu to menu; menu to Home Page.
7. Press and hold the Infinity Key  for two seconds to return to the Home Page.

On the following pages, top level menus are identified with a yellow background color.

Note:

Some of these menus and parameters may not appear, depending on the controller's options. See model number information in the Appendix for more information. If there is only one instance of a menu, no submenus will appear.

Note:

Some of the listed parameters may not be visible. Parameter visibility is dependent upon controller part number.

CUSE	ACE Calibration
FCEY Custom Setup Menu	PNW Electrical Measurement
1 to 30	EL 40 Electrical Input Offset
CUSE Custom Setup	EL 45 Electrical Input Slope
PRC Parameter	
<i>i, d</i> Instance ID	
LoC	
FCEY Security Setting Menu	
LoC Security Setting	
LoLo Operations Page	
PRSE Password	
rLoC Read Lock	
SLoC Write Security	
LoLL Locked Access Level	
roLL Rolling Password	
PRSw User Password	
PRSR Administrator Password	
ULoC	
FCEY Security Setting Menu	
LoC Security Setting	
LoDE Public Key	
PRSS Password	
d, R9	
FCEY Diagnostics Menu	
d, R9 Diagnostics	
Pn Part Number	
rEw Software Revision	
SbLd Software Build Number	
Sn Serial Number	
dRtE Date of Manufacture	
CRl	
FCEY Calibration Menu	
1 to 12	

Display	Parameter Name Description	Range	Default	Modbus Relative Address	CIP Class Instance Attribute hex (dec)	Profibus Index	Parameter ID	Data Type & Read/Write
[CUSE] [FCEY] Custom Setup Menu								
[PRP] [Par]	Custom Menu Parameter 1 to 30 Select the parameters that will appear in the Home Page when using the RUL. The Parameter 1 value will appear in the upper display of the Home Page. It cannot be changed with the Up and Down Keys in the Home Page. The Parameter 2 value will appear in the lower display in the Home Page. It can be changed with the Up and Down Keys, if the parameter is a writable one. Scroll through the other Home Page parameters with the Advance Key .	[none] None (61) [Pro] Process (75) [ICR] Input Calibration Offset (1196) [CF] Display Units (156) [USR] User Restore Set (227) [ALO] Alarm Low Set Point (42) [AHI] Alarm High Set Point (78) [AHY] Alarm Hysteresis (97) [LLS] Limit Low Set Point (181) [LHS] Limit High Set Point (182) [LHY] Limit Hysteresis (183) [LSE] Limit Status (1668) [CUSE] Custom Menu (180)	Process Limit Status	----	----	----	14005	uint RWES
[iid] [iid]	Custom Setup (1 to 30) Instance ID Select the parameters that will appear in the Home Page.	1 to 24	----	----	----	----	14003	uint RWES
[LoC] [FCEY] Security Setting Menu								
[LoC.o] [LoC.o]	Security Setting Operations Page Change the security level of the Operations Page.	1 to 3	2	----	----	----	----	----
[PASE] [LoC.P]	Security Setting Password Enable Turn security features on or off.	[off] Off [on] On	Off	----	----	----	----	----
[rLoC] [rLoC]	Security Setting Read Lock Set the read security clearance level. The user can access the selected level and all lower levels. If the Set Lockout Security level is higher than the Read Lockout Security, the Read Lockout Security level takes priority.	1 to 5	5	----	----	----	----	----
Note: Some values will be rounded off to fit in the four-character display. Full values can be read with another interface. If there is only one instance of a menu, no submenus will appear.								R: Read W: Write E: EE-PROM S: User Set

Display	Parameter Name Description	Range	Default	Modbus Relative Address	CIP Class Instance Attribute hex (dec)	Profibus Index	Parameter ID	Data Type & Read/ Write
[SLoC] [SLoC]	<i>Security Setting</i> Write Security Set the write security clearance level. The user can access the selected level and all lower levels. If the Set Lockout Security level is higher than the Read Lockout Security, the Read Lockout Security level takes priority.	0 to 5	5	----	----	----	----	----
[LoCL] [LoC.L]	<i>Security Setting</i> Locked Access Level Determines user level menu visibility when security is enabled. See Features section under Password Security.	1 to 5	5	----	----	----	----	----
No Display	<i>Security Setting</i> Locked State Current level of security	Lock (228) User (1684) Admin (1685)	----	----	----	----	3023	uint R
[roLL] [roLL]	<i>Security Setting</i> Rolling Password When power is cycled a new Public Key will be displayed.	<input type="checkbox"/> oFF Off <input type="checkbox"/> oN On	Off	----	----	----	----	----
[PAS.u] [PAS.u]	<i>Security Setting</i> User Password Used to acquire access to menus made available through the Locked Access Level setting.	10 to 999	63	----	----	----	----	----
[PAS.A] [PAS.A]	<i>Security Setting</i> Administrator Password Used to acquire full access to all menus.	10 to 999	156	----	----	----	----	----
[ULoC] [FLtY] Security Setting Menu								
[CodE] [CodE]	<i>Security Setting</i> Public Key If Rolling Password turned on, generates a random number when power is cycled. If Rolling Password is off fixed number will be displayed.	Customer Specific	0	----	----	----	----	----
[PASS] [PASS]	<i>Security Setting</i> Password Number returned from calculation found in Features section under Password Security.	-1999 to 9999	0	----	----	----	----	----
<p>Note: Some values will be rounded off to fit in the four-character display. Full values can be read with another interface.</p> <p>If there is only one instance of a menu, no submenus will appear.</p>								R: Read W: Write E: EE-PROM S: User Set

Display	Parameter Name Description	Range	Default	Modbus Relative Address	CIP Class Instance Attribute hex (dec)	Profibus Index	Parameter ID	Data Type & Read/ Write
d .R9 FCLY Diagnostics Menu								
Pn [Pn]	<i>Diagnostics Menu</i> Part Number Display this controller's part number.	24	----		0x65 (101) 1 9	66	1009	uint RWE
No Display	<i>Diagnostics Menu</i> Device Name Read the hardware ID.	0 to 2,147,483,647	----	----	0x65 (101) 1 0x0B (11)	----	1011	float RWE
No Display	<i>Diagnostics Menu</i> Device Status Read the hardware ID.	0 to 2,147,483,647	----	30	0x65 (101) 1 0x10 (16)	----	1016	float RWE
rEu [rEu]	<i>Diagnostics Menu</i> Software Revision Display this controller's firm-ware revision number.	5	----	4	0x65 (101) 1 to 5 0x11 (17)	67	1017	uint R
SbLd [S.bLd]	<i>Diagnostics Menu</i> Software Build Number Display the firmware build number.	0 to 2,147,483,647	----	8	0x65 (101) 1 to 5 5	----	1005	float R
Sn [Sn]	<i>Diagnostics Menu</i> Serial Number Display the serial number.	0 to 2,147,483,647	----	12	0x65 (101) 1 7	----	1032	float RWE
dAtE [dAtE]	<i>Diagnostics Menu</i> Date of Manufacture Display the date code. Date code format is YYWW, where YY is last two digits of the year, and WW is the week of the year.	0 to 2,147,483,647	----	14	0x65 (101) 1 8	----	1008	float RWE
No Display	<i>Diagnostics Menu</i> Hardware ID Read the hardware ID.	0 to 2,147,483,647	----	0	0x65 (101) 1 1	----	1001	float RWE
CRl FCLY Calibration Menu								
rMv [Mv]	<i>Calibration Menu (1 to 12)</i> Electrical Measurement Read the raw electrical value for this input in the units corresponding to the Sensor Type (Setup Page, Analog Input Menu) setting.	-3.4e38 to 3.4e38		450 [offset 90]	0x68 (104) 1 to 0x0C (12) 0x15 (21)	----	4021	float R
ELo [ELi.o]	<i>Calibration Menu (1 to 12)</i> Electrical Input Offset Change this value to calibrate the low end of the input range.	-1,999.000 to 9,999.000	0.0	428 [offset 90]	0x68 (104) 1 to 0x0C (12) 0xA (10)	----	4010	float RWES
Note: Some values will be rounded off to fit in the four-character display. Full values can be read with another interface. If there is only one instance of a menu, no submenus will appear.								R: Read W: Write E: EE- PROM S: User Set

Display	Parameter Name Description	Range	Default	Modbus Relative Address	CIP Class Instance Attribute hex (dec)	Profibus Index	Parameter ID	Data Type & Read/ Write
EL.S [ELi.S]	<i>Calibration Menu (1 to 12)</i> Electrical Input Slope Adjust this value to calibrate the slope of the input value.	-1,999.000 to 9,999.000	1.0	430 [offset 90]	0x68 (104) 1 to 0x0C (12) 0xB (11)	- - - -	4011	float RWES
<p>Note: Some values will be rounded off to fit in the four-character display. Full values can be read with another interface.</p> <p>If there is only one instance of a menu, no submenus will appear.</p>								R: Read W: Write E: EE- PROM S: User Set

6

Chapter 6: Features

Saving and Restoring User Settings	79
Module Limit	79
Inputs	79
Calibration Offset	79
Calibration	79
Filter Time Constant	80
Sensor Selection	80
Set Point Low Limit and High Limit	80
Scale High and Scale Low	80
Range High and Range Low	81
Linearization	81
Alarms	81
Process Alarms	81
Alarm Set Points	81
Alarm Hysteresis	81
Alarm Latching	81
Alarm Silencing	82
Alarm Blocking	82
Using Lockout to Hide Pages and Menus	82
Lockout Menu	82
Using Password Security	83
How to Enable Password Security	83
Modbus - Using Programmable Memory Blocks	84
Software Configuration	85
Function Block Descriptions	88
Action Function	88
Alarm Function	88
Analog Input Function	89
Compare Function	90
Counter Function	92
Custom Function	92
Diagnostic Function	92
Digital Input/Output Function	93
Global Function	93
Limit Function	94
Linearization Function	94
Logic Function	95
Math Function	98
Output Function	103
Security Function	104
Timer Function	105
Variable Function	110
RML Specifications	117

Saving and Restoring User Settings

Recording setup and operations parameter settings for future reference is very important. If you unintentionally change these, you will need to program the correct settings back into the controller to return the equipment to operational condition.

After you program the controller and verify proper operation, use User Save Set **[USR.S]** (Setup Page, Global Menu) to save the settings into either of two files in a special section of memory. If the settings in the controller are altered and you want to return the controller to the saved values, use User Restore Set **[USR.R]** (Setup Page, Global Menu) to recall one of the saved settings.

A digital input or the Function Key can also be configured to restore parameters.

Note:

Only perform the above procedure when you are sure that all the correct settings are programmed into the controller. Saving the settings overwrites any previously saved collection of settings. Be sure to document all the controller settings.

Module Limit

This feature allows the user to setup a single output to reflect an energized (safe) or deenergized (tripped) state for the module. The reference to an energized or deenergized state refers to the internal coil that drives the Form A relay. When energized (safe) the contact is closed, when deenergized the contact is open. If any configured limit is tripped (process value exceeds set point or limit input has malfunctioned), the output LED assigned to serve as this function will come on. By default (factory settings), output 8 is assigned this function where any output of choice can be configured as such.

Note:

If limit loops exist on the module that are not intended to be used immediately, the loop must be setup to avoid a trip condition. To do this simply jumper the input for the unused loops and then ensure that the set point will never be exceeded (Operations Page, Limit Menu) by the process variable.

Inputs

Calibration Offset

Calibration offset allows a device to compensate for an inaccurate sensor, lead resistance or other factors that affect the input value. A positive offset increases the input value, and a negative offset decreases the input value.

The input offset value can be viewed or changed with Calibration Offset **[CAL]** (Operations Page, Analog Input Menu).

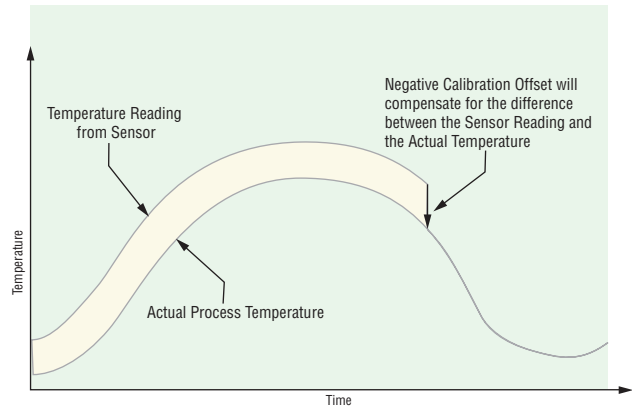

Calibration

To calibrate an analog input, you will need to provide two electrical signals or resistance loads near the extremes of the range that the application is likely to utilize. See recommended values below:

Sensor Type	Low Source	High Source
thermocouple	0.000 mV	50.000 mV
millivolts	0.000 mV	50.000 mV
volts	0.000V	10.000V
milliamps	0.000 mA	20.000 mA
100 Ω RTD	50.00 Ω	350.00 Ω
1,000 Ω RTD	500.00 Ω	3,500.00 Ω
Thermistor 5K	50.00 Ω	5000.00 Ω
Thermistor 10K	50.00 Ω	10000.00 Ω
Thermistor 20K	50.00 Ω	20000.00 Ω
Thermistor 40K	50.00 Ω	40000.00 Ω

Follow these steps for a thermocouple or process input:

1. Apply the low source signal to the input you are calibrating. Measure the signal to ensure it is accurate.
2. Read the value of Electrical Measurement **[E.M.]** (Factory Page, Calibration Menu) for that input.
3. Calculate the offset value by subtracting this value from the low source signal.
4. Set Electrical Input Offset **[EL.O.]** (Factory Page, Calibration Menu) for this input to the offset value.

5. Check the Electrical Measurement to see whether it now matches the signal. If it doesn't match, adjust Electrical Offset again.
6. Apply the high source signal to the input. Measure the signal to ensure it is accurate.
7. Read the value of Electrical Measurement for that input.
8. Calculate the gain value by dividing the low source signal by this value.
9. Set Electrical Slope **[EL 1.5]** (Factory Page, Calibration Menu) for this input to the calculated gain value.
10. Check the Electrical Measurement to see whether it now matches the signal. If it doesn't match, adjust Electrical Slope again.

Set Electrical Offset to 0 and Electrical Slope to 1 to restore factory calibration.

Follow these steps for an RTD input:

1. Measure the low source resistance to ensure it is accurate. Connect the low source resistance to the input you are calibrating.
2. Read the value of Electrical Measurement **[P7.0]** (Factory Page, Calibration Menu) for that input.
3. Calculate the offset value by subtracting this value from the low source resistance.
4. Set Electrical Input Offset **[EL 1.0]** (Factory Page, Calibration Menu) for this input to the offset value.
5. Check the Electrical Measurement to see whether it now matches the resistance. If it doesn't match, adjust Electrical Offset again.
6. Measure the high source resistance to ensure it is accurate. Connect the high source resistance to the input.
7. Read the value of Electrical Measurement for that input.
8. Calculate the gain value by dividing the low source signal by this value.
9. Set Electrical Slope **[EL 1.5]** (Factory Page, Calibration Menu) for this input to the calculated gain value.
10. Check the Electrical Measurement to see whether it now matches the signal. If it doesn't match, adjust Electrical Slope again.

Set Electrical Offset to 0 and Electrical Slope to 1 to restore factory calibration.

Filter Time Constant

Filtering smoothes an input signal by applying a first-order filter time constant to the signal. Filtering the displayed value makes it easier to monitor. Filtering the signal may improve the performance of PID control in a noisy or very dynamic system.

Adjust the filter time interval with Filter Time **[F 1.0]** (Setup Page, Analog Input Menu). Example: With a filter value of 0.5 seconds, if the process input value instantly changes from 0 to 100 and remained at

100, the display will indicate 100 after five time constants of the filter value or 2.5 seconds.

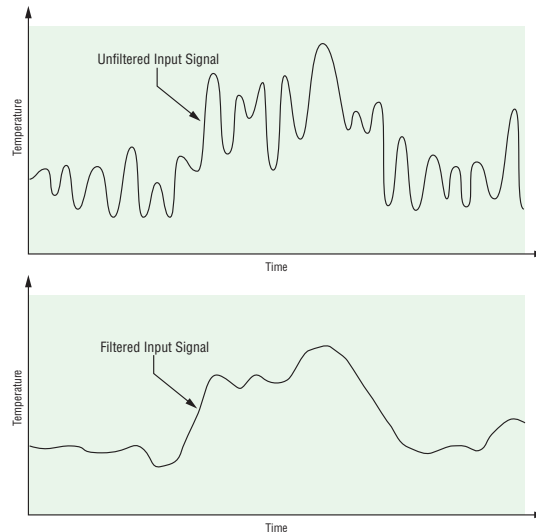

Sensor Selection

You need to configure the controller to match the input device, which is normally a thermocouple, RTD or process transmitter.

Select the sensor type with Sensor Type **[SE 0]** (Setup Page, Analog Input Menu).

Set Point Low Limit and High Limit

The controller constrains the set point to a value between a set point low limit and a set point high limit.

Set the set point limits with Low Set Point **[LSP]** and High Set Point **[hSP]** (Setup Page, Loop Menu).

There are two sets of set point low and high limits: one for a closed-loop set point, another for an open-loop set point.

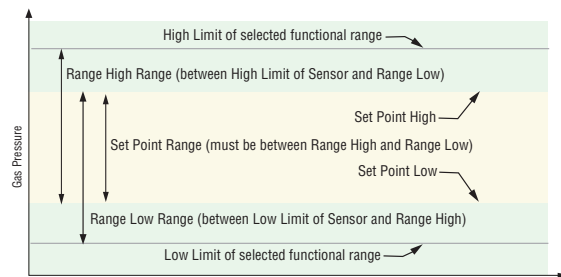

Scale High and Scale Low

When an analog input is selected as process voltage or process current input, you must choose the value of voltage or current to be the low and high ends. For example, when using a 4 to 20 mA input, the scale low value would be 4.00 mA and the scale high value would be 20.00 mA. Commonly used scale ranges are: 0 to 20 mA, 4 to 20 mA, 0 to 5V, 1 to 5V and 0 to 10V.

You can create a scale range representing other units for special applications. You can reverse scales from high values to low values for analog input signals that have a reversed action. For example, if 50 psi causes a 4 mA signal and 10 psi causes a 20 mA signal.

Scale low and high values do not have to match the bounds of the measurement range. These along with range low and high provide for process scaling and can include values not measurable by the controller. Regardless of scaling values, the measured value will be constrained by the electrical measurements of the hardware.

Select the low and high values with Scale Low **[SLo]** and Scale High **[Shi]**. Select the displayed range with Range Low **[rLo]** and Range High **[rhi]** (Setup Page, Analog Input Menu).

Range High and Range Low

With a process input, you must choose a value to represent the low and high ends of the current or voltage range. Choosing these values allows the controller's display to be scaled into the actual working units of measurement. For example, the analog input from a humidity transmitter could represent 0 to 100 percent relative humidity as a process signal of 4 to 20 mA. Low scale would be set to 0 to represent 4 mA and high scale set to 100 to represent 20 mA. The indication on the display would then represent percent humidity and range from 0 to 100 percent with an input of 4 to 20 mA.

Select the low and high values with Range Low **[rLo]** and Range High **[rhi]** (Setup Page, Analog Input Menu).

Linearization

The linearization function allows a user to re-linearize a value read from an analog input. There are 10 data points used to compensate for differences between the sensor value read (input point) and the desired value (output point). Multiple data points enable compensation for non-linear differences between the sensor readings and target process values over the thermal or process system operating range. Sensor reading differences can be caused by sensor placement, tolerances, an inaccurate sensor or lead resistance.

The user specifies the unit of measurement and then each data point by entering an input point value and a corresponding output point value. Each data point must be incrementally higher than the previous point. The linearization function will interpolate data points linearly in between specified data points.

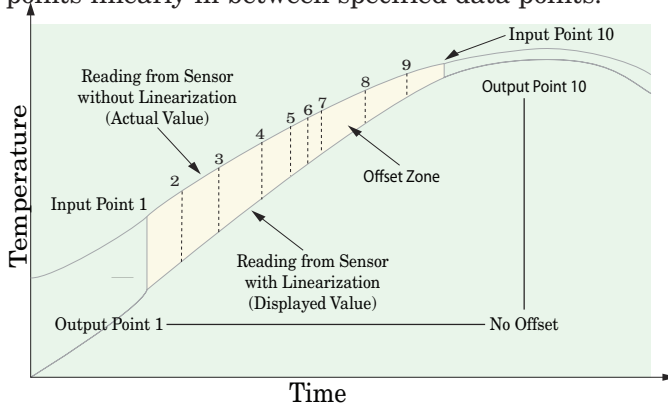

Alarms

Alarms are activated when the output level, process value or temperature leaves a defined range. A user can configure how and when an alarm is triggered, what action it takes and whether it turns off automatically when the alarm condition is over.

Configure alarm outputs in the Setup Page before setting alarm set points.

Alarms do not have to be assigned to an output. Alarms can be monitored and controlled through the front panel or by using software.

Process Alarms

A process alarm uses one or two absolute set points to define an alarm condition.

Enable an alarm by first navigating to the alarm type **[ALY]** (Setup Page, Alarm Menu) and then select the Process **[Pr,RL]** alarm.

Alarm Set Points

The alarm high set point defines the process value or temperature that will trigger a high side alarm. The alarm low set point defines the temperature that will trigger a low side alarm. View or change alarm set points with Low Set Point **[ALo]** and High Set Point **[Ahi]** (Operations Page, Alarm Menu).

Alarm Hysteresis

An alarm state is triggered when the process value reaches the alarm high or alarm low set point. Alarm hysteresis defines how far the process must return into the normal operating range before the alarm can be cleared.

Alarm hysteresis is a zone inside each alarm set point. This zone is defined by adding the hysteresis value to the alarm low set point or subtracting the hysteresis value from the alarm high set point. View or change alarm hysteresis with Hysteresis **[Ahy]** (Setup Page, Alarm Menu).

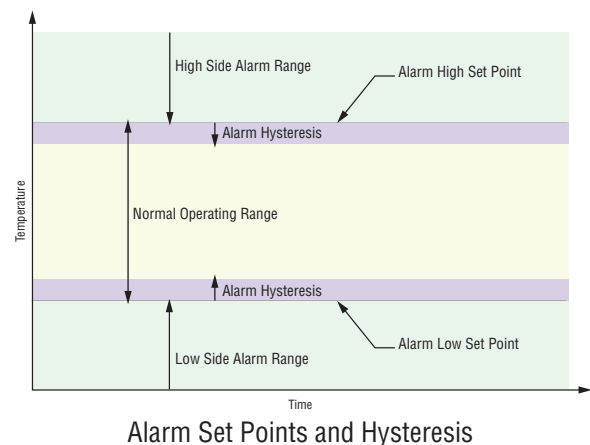

Alarm Latching

A latched alarm will remain active after the alarm

condition has passed. It can only be deactivated by the user.

An active message, such as an alarm message, will cause the RUI display to toggle between the normal settings and the active message in the upper display and **ALERT** in the lower display.

Push the Advance Key **⏩** to display **IGNR** in the upper display and the message source in the lower display.

Use the Up **⬆** or Down **⬇** keys to scroll through possible responses, such as Clear **CLR** or Silence **SIL**. Then push the Advance **⏩** or Infinity **∞** key to execute the action.

See the Keys and Displays chapter and the Home Page chapter for more details.

An alarm that is not latched (self-clearing) will deactivate automatically when the alarm condition has passed.

Turn alarm latching on or off with Latching **ALLA** (Setup Page, Alarm Menu).

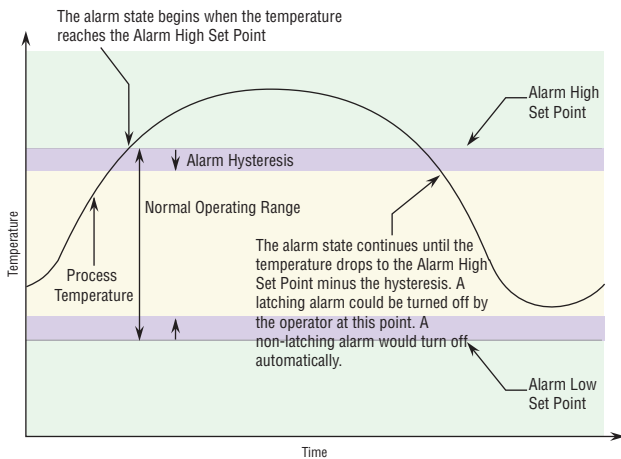

Alarm Silencing

If alarm silencing is on the operator can disable the alarm output while the controller is in an alarm state. The process value or temperature has to enter the normal operating range beyond the hysteresis zone to activate the alarm output function again.

An active message, such as an alarm message, will cause the display to toggle between the normal settings and the active message in the upper display and **ALERT** in the lower display.

Push the Advance Key **⏩** to display **IGNR** in the upper display and the message source in the lower display.

Use the Up **⬆** and Down **⬇** keys to scroll through possible responses, such as Clear **CLR** or Silence **SIL**. Then push the Advance **⏩** or Infinity **∞** key to execute the action.

Turn alarm silencing on or off with Silencing **RSI** (Setup Page, Alarm Menu).

Alarm Blocking

Alarm blocking allows a system to warm up after it has been started up. With alarm blocking on, an alarm is not triggered when the process temperature is initially lower than the alarm low set point or higher than the alarm high set point. The process temperature has to enter the normal operating range beyond the hysteresis zone to activate the alarm function.

Turn alarm blocking on or off with Blocking **ABL** (Setup Page, Alarm Menu).

Using Lockout to Hide Pages and Menus

If unintentional changes to parameter settings might raise safety concerns or lead to downtime, you can use the lockout feature to make them more secure.

Each of the menus in the Factory Page and each of the pages, except the Factory Page, has a security level assigned to it. You can change the read and write access to these menus and pages by using the parameters in the Lockout Menu (Factory Page).

Lockout Menu

There are five parameters in the Lockout Menu (Factory Page):

- Lock Operations Page **LOCO** sets the security level for the Operations Page. (default: 2)

Note:

The Home and Setup Page lockout levels are fixed and cannot be changed.

- Lock Profiling Page **LOCP** sets the security level for the Profiling Page. (default: 3)
- Password Security Enable **PSSE** will turn on or off the Password security feature. (default: off)
- Read Lockout Security **RLOC** determines which pages can be accessed. The user can access the selected level and all lower levels. (default: 5)
- Set Lockout Security **SLOC** determines which parameters within accessible pages can be written to. The user can write to the selected level and all lower levels. (default: 5)

The table below represents the various levels of lockout for the Set Lockout Security prompt and the Read Lockout Security prompt. The Set Lockout has 6 levels (0-5) of security where the Read Lockout has 5 (1-5). Therefore, level "0" applies to Set Lockout only. "Y" equates to yes (can write/read) where "N" equates to no (cannot write/read). The colored cells simply differentiate one level from the next.

Lockout Security \overline{SLoC} & \overline{rLoC}						
Lockout Level	0	1	2	3	4	5
Home Page (0)	Y	Y	Y	Y	Y	Y
Operations Page (2)	N	N	Y	Y	Y	Y
Setup Page (4)	N	N	N	N	Y	Y
Factory Page						
Custom Menu (5)	N	N	N	N	N	Y
Diagnostic Menu (2)	N	Y	Y	Y	Y	Y
Calibration Menu (5)	N	N	N	N	N	Y
Lockout Menu						
$\overline{LoC.O}$	N	Y	Y	Y	Y	Y
$\overline{LoC.P}$	N	Y	Y	Y	Y	Y
\overline{PASE}	N	Y	Y	Y	Y	Y
\overline{rLoC}	Y	Y	Y	Y	Y	Y
\overline{SLoC}	Y	Y	Y	Y	Y	Y

The following examples show how the Lockout Menu parameters may be used in applications:

1. You can lock out access to the Operations Page but allow an operator access to the Profile Menu, by changing the default Profile Page and Operations Page security levels. Change Lock Operations Page $\overline{LoC.O}$ to 3 and Lock Profiling Page $\overline{LoC.P}$ to 2. If Set Lockout Security \overline{SLoC} is set to 2 or higher and the Read Lockout Security \overline{rLoC} is set to 2, the Profiling Page and Home Pages can be accessed, and all writable parameters can be written to. Pages with security levels greater than 2 will be locked out (inaccessible).
2. If Set Lockout Security \overline{SLoC} is set to 0 and Read Lockout Security \overline{rLoC} is set to 5, all pages will be accessible, however, changes will not be allowed on any pages or menus, with one exception: Set Lockout Security \overline{SLoC} can be changed to a higher level.
3. The operator wants to read all the menus and not allow any parameters to be changed.
In the Factory Page, Lockout Menu, set Read Lockout Security \overline{rLoC} to 5 and Set Lockout Security \overline{SLoC} to 0.
4. The operator wants to read and write to the Home Page and Profiling Page, and lock all other pages and menus.
In the Factory Page, Lockout Menu, set Read Lockout Security \overline{rLoC} to 2 and Set Lockout Security \overline{SLoC} to 2.
In the Factory Page, Lockout Menu, set Lock Operations Page $\overline{LoC.O}$ to 3 and Lock Profiling Page $\overline{LoC.P}$ to 2.
5. The operator wants to read the Operations Page, Setup Page, Profiling Page, Diagnostics Menu, Lock Menu, Calibration Menu and Custom Menus. The operator also wants to read and write to the Home Page.
In the Factory Page, Lockout Menu, set Read

Lockout Security \overline{rLoC} to 1 and Set Lockout Security \overline{SLoC} to 5.

In the Factory Page, Lockout Menu, set Lock Operations Page $\overline{LoC.O}$ to 2 and Lock Profiling Page $\overline{LoC.P}$ to 3.

Using Password Security

It is sometimes desirable to apply a higher level of security to the control where a limited number of menus are visible and not providing access to others without a security password. Without the appropriate password those menus will remain inaccessible. If Password Enabled (\overline{PASE}) in the Factory Page under the \overline{LoC} Menu is set to on, an overriding Password Security will be in effect. When in effect, the only Pages that a User without a password has visibility to are defined in the Locked Access Level $\overline{LoC.L}$ prompt. On the other hand, a User with a password would have visibility restricted by the Read Lockout Security \overline{rLoC} . As an example, with Password Enabled and the Locked Access Level $\overline{LoC.L}$ set to 1 and \overline{rLoC} is set to 3, the available Pages for a User without a password would be limited to the Home and Factory Pages (locked level 1). If the User password is entered all pages would be accessible with the exception of the Setup Page as defined by level 3 access.

How to Enable Password Security

Go to the Factory Page by holding down the Infinity ∞ key and the Advance \rightarrow key for approximately six seconds. Once there, push the Down \downarrow key one time to get to the \overline{LoC} menu. Again push the Advance \rightarrow key until the Password Enabled (\overline{PASE}) prompt is visible. Lastly, push either the up or down key to turn it on. Once on, 4 new prompts will appear:

1. $\overline{LoC.L}$, Locked Access Level (1 to 5) correspond to the lockout table above.
2. \overline{rLoC} , Rolling Password will change the Customer Code every time power is cycled.
3. $\overline{PASE.U}$, User Password which is needed for a User to acquire access to the control.
4. $\overline{PASE.A}$, Administrator Password which is needed to acquire administrative access to the control.

The Administrator can either change the User and or the Administrator password or leave them in the default state. Once Password Security is enabled they will no longer be visible to anyone other than the Administrator. As can be seen in the formula that follows either the User or Administrator will need to know what those passwords are to acquire a higher level of access to the control. Back out of this menu by pushing the Infinity ∞ key. Once out of the menu, the Password Security will be enabled.

How to Acquire Access to the Control

To acquire access to any inaccessible Pages or Menus, go to the Factory Page and enter the \overline{ULoC} menu. Once there follow the steps below:

Note:

If Password Security (Password Enabled $[PASS.E]$ is On) is enabled the two prompts mentioned below in the first step will not be visible. If unknown, call the individual or company that originally set-up the control.

1. Acquire either the User Password $[PASS.U]$ or the Administrator Password $[PASS.A]$.
2. Push the Advance \odot key one time where the Code $[CODE]$ prompt will be visible.

Note:

- a. If the the Rolling Password is off push the Advance key one more time where the Password $[PASS]$ prompt will be displayed. Proceed to either step 7a or 8a. Pushing the Up \blacktriangle or Down \blacktriangledown arrow keys enter either the User or Administrator Password. Once entered, push and hold the Infinity ∞ key for two seconds to return to the Home Page.
 - b. If the Rolling Password $[ROLL]$ was turned on proceed on through steps 3 - 9.
3. Assuming the Code $[CODE]$ prompt (Public Key) is still visible on the face of the control simply push the Advance key \odot to proceed to the Password $[PASS]$ prompt. If not find your way back to the Factory Page as described above.
 4. Execute the calculation defined below (7b or 8b) for either the User or Administrator.
 5. Enter the result of the calculation in the upper display play by using the Up \blacktriangle and Down \blacktriangledown arrow keys or use EZ-ZONE Configurator Software.
 6. Exit the Factory Page by pushing and holding the Infinity ∞ key for two seconds.

Formulas used by the User and the Administrator to calculate the Password follows:

Passwords equal:

7. User

- a. If Rolling Password $[ROLL]$ is Off, Password $[PASS]$ equals User Password $[PASS.U]$.
- b. If Rolling Password $[ROLL]$ is On, Password $[PASS]$ equals:

$$((PASS.U) \times code) \text{ Mod } 929 + 70$$

8. Administrator

- a. If Rolling Password $[ROLL]$ is Off, Password $[PASS]$ equals User Password $[PASS.A]$.
- b. If Rolling Password $[ROLL]$ is On, Password $[PASS]$ equals:

$$((PASS.A) \times code) \text{ Mod } 997 + 1000$$

Differences Between a User Without Password, User With Password and Administrator

- User **without** a password is restricted by the

Locked Access Level $[LOCL]$.

- A User **with** a password is restricted by the Read Lockout Security $[rLoL]$ never having access to the Lock Menu $[LoL]$.
- An Administrator is restricted according to the Read Lockout Security $[rLoL]$ however, the Administrator has access to the Lock Menu where the Read Lockout can be changed.

Modbus - Using Programmable Memory Blocks

When using the Modbus protocol, the RML features a block of addresses that can be configured by the user to provide direct access to a list of 80 user configured parameters. This allows the user easy access to this customized list by reading from or writing to a contiguous block of registers.

To acquire a better understanding of the tables found in the back of this guide (See Appendix: [Modbus Programmable Memory Blocks](#)) please read through the text below which defines the column headers used.

Assembly Pointer Addresses

- Fixed addresses used to define the parameter that will be stored in the "Working Addresses", which may also be referred to as a pointer. The value stored in these addresses will reflect (point to) the Modbus address of a parameter within the controller.

Assembly Working Addresses

- Fixed addresses directly related to their associated "Assembly Definition Addresses" (e.g., Assembly Working Addresses 200 & 201 will assume the parameter pointed to by Assembly Definition Addresses 40 & 41).

When the Modbus address of a target parameter is stored in an "Pointer Register" its corresponding working address will return that parameter's actual value. If it's a writable parameter, writing to its working register will change the parameter's actual value.

As an example, Modbus register 410 contains the Analog Input 1 Process Value (See Operations Page, Analog Input Menu). If the value 410 and 411 is loaded into Assembly Pointer Addresses 90 and 91, the process value sensed by analog input 1 will also be stored in Modbus registers 250 and 251. Note that by default all registers are set to the Hardware ID.

The table (See Appendix: [Modbus Programmable Memory Blocks](#)) identified as "Assembly Definition Addresses and Assembly Working Addresses" reflects the assemblies and their associated addresses.

Software Configuration

Using EZ-ZONE® Configurator Software

To enable a user to configure the RML control using a personal computer (PC), Watlow has provided free software for your use. If you have not yet obtained a copy of this software insert the CD (Controller Support Tools) into your CD drive and install the software. Alternatively, if you are viewing this document electronically and have a connection to the internet simply click on the link below and download the software from the Watlow web site free of charge.

http://www.watlow.com/products/software/zone_config.cfm

Once the software is installed double click on the EZ-ZONE Configurator icon placed on your desktop during the installation process. If you cannot find the icon follow the steps below to run the software:

1. Move your mouse to the "Start" button
2. Place the mouse over "All Programs"
3. Navigate to the "Watlow" folder and then the sub-folder "EZ-ZONE Configurator"
4. Click on EZ-ZONE Configurator to run.

The first screen that will appear is shown below.

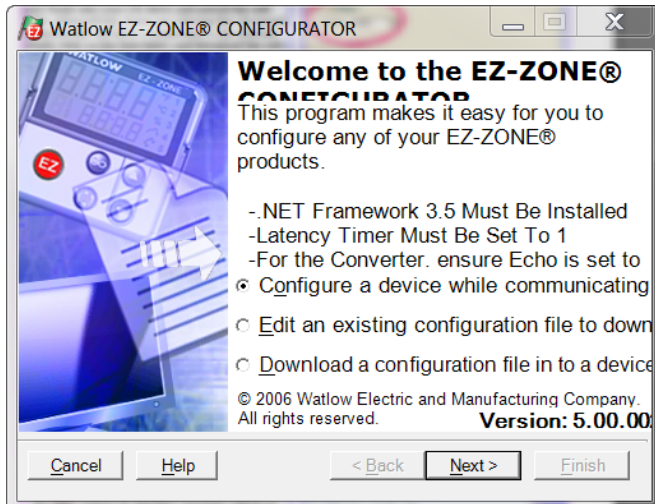

If the PC is already physically connected to the EZ-ZONE RML control click the next button to go on-line.

Note:

When establishing communications from PC to the RML control an interface converter will be required. The Standard Bus network uses EIA-485 as the interface. Most PCs today would require a USB to EIA-485 converter. However, some PCs may still be equipped with EIA-232 ports, therefore an EIA-232 to EIA-485 converter would be required.

As can be seen in the above screen shot the software provides the user with the option of downloading a previously saved configuration as well as the ability to create a configuration off-line to download later. The screen shots that follow will take the user on-line.

After clicking the next button above it is necessary to define the communications port on the PC to use.

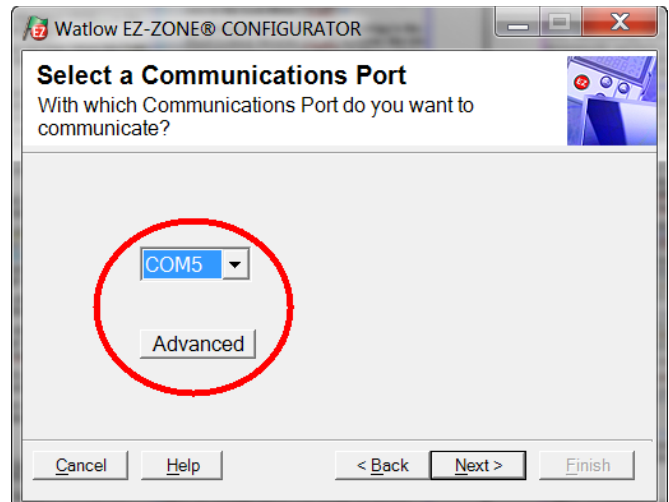

The available options allow the user to select "Try them all" or to use a specific known communications port. After installation of your converter if you are not sure which communications port was allocated select "Try them all" and then click next. The screen to follow shows that the software is scanning for devices on the network and that progress is being made.

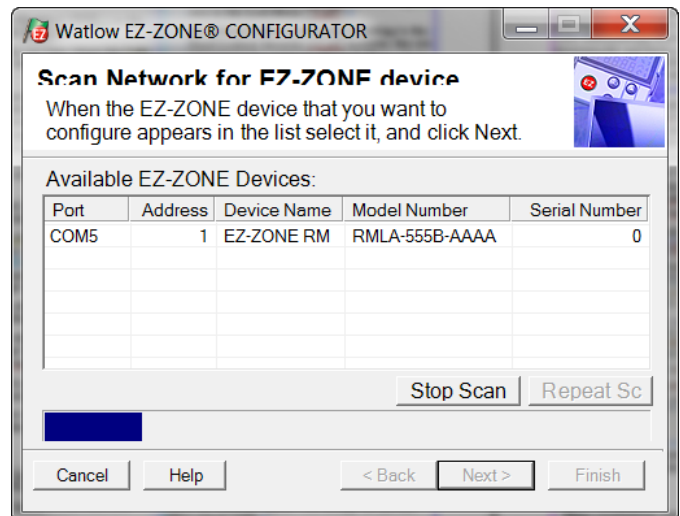

When complete, the software will display all of the available devices found on the network as shown below.

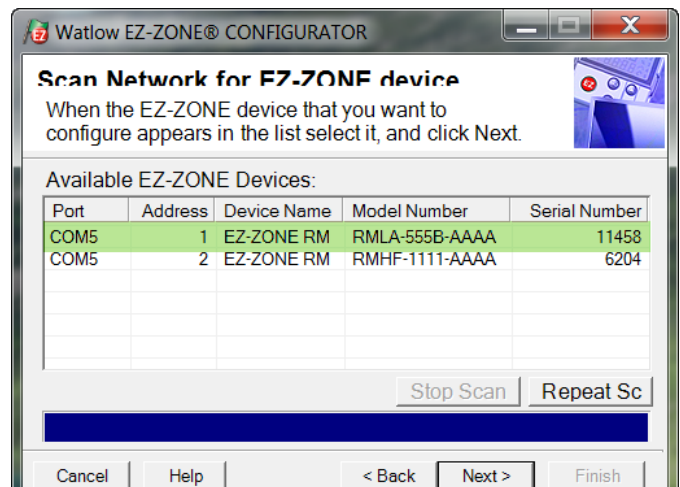

In the previous screen shot the RML is shown highlighted (address 11) to bring greater clarity to the control in focus. Any EZ-ZONE device on the network will appear in this window and would be available for the purpose of configuration or monitoring. After clicking on the control of choice simply click the next button once again. The next screen appears below.

eter will appear in the center column. The grayed out fields in the center column simply mean that this does not apply for the type of sensor selected. As an example, notice that when Volts is selected, TC Linearization does not apply and is therefore grayed out. To speed up the process of configuration notice that at the bottom of the center column there is an oper-

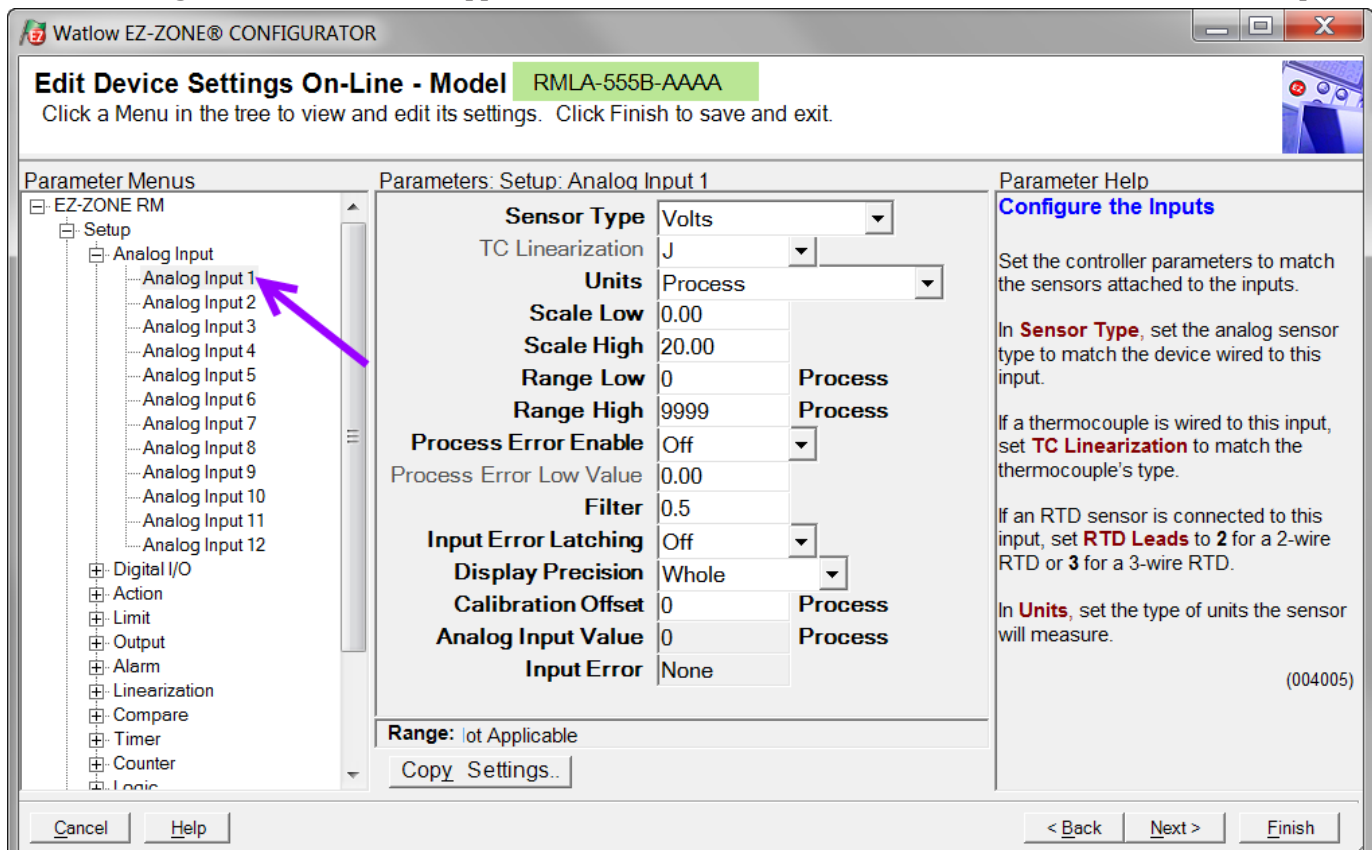

In the screen shot above notice that the device part number is clearly displayed at the top of the page (green highlight added for emphasis). When multiple EZ-ZONE devices are on the network it is important that the part number be noted prior to configuring so as to avoid making unwanted configuration changes to another control.

Looking closely at the left hand column (Parameter Menus) notice that it displays all of the available menus and associated parameters within the control. The menu structure as laid out within this software follows:

- Setup
- Operations
- Factory

Navigating from one menu to the next is easy and clearly visible. Simply slide the scroll bar up or down to display the menu and parameter of choice. As an alternative, clicking on the negative symbol next to Setup will collapse the Setup Menu where the Operations Menu will appear next and perhaps deliver more clarity for the area of focus by not displaying unwanted menus and parameters. Once the focus is brought to an individual parameter (single click of mouse) as is the case for Analog Input 1 in the left column, all that can be setup related to that param-

ation to copy settings. If Analog Input 1 and 2 are the same type of sensor click on "Copy Settings" where a copy from to copy to dialog box will appear allowing for quick duplication of all settings.

Notice too, that by clicking on any of those items in the center column that context sensitive help will appear for that particular item in the right hand column.

Lastly, when the configuration is complete click the "Finish" button at the bottom right of the previous screen shot. The screen that follows this action can be seen below.

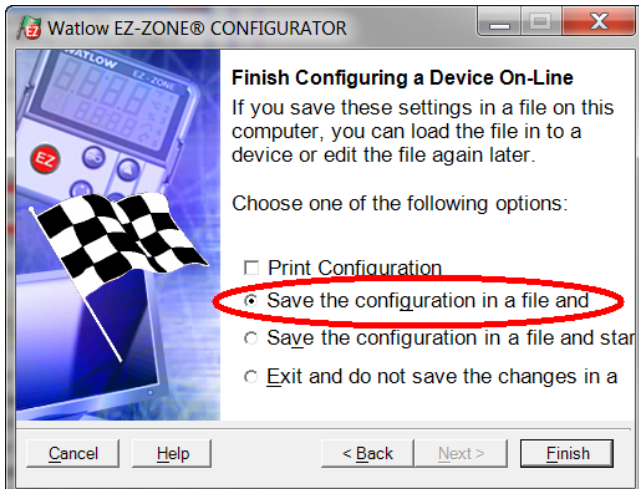

Although the RML control now contains the configuration (because the previous discussion focused on doing the configuration on-line) it is suggested that after the configuration process is completed that the user save this file on the PC for future use. If for some reason someone inadvertently changed a setting without understanding the impact it would be easy and perhaps faster to download a saved configuration back to the control versus trying to figure out what was changed.

Of course, there is an option to exit without saving a copy to the local hard drive.

After selecting Save above click the "Finish" button once again. The screen below will than appear.

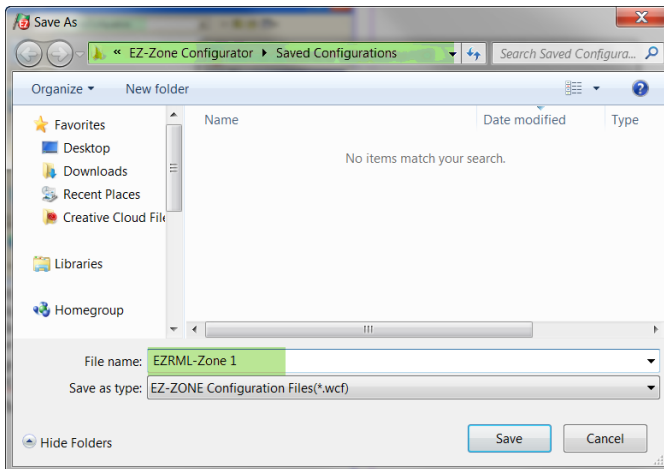

When saving the configuration note the location where the file will be placed (Saved in) and enter the file name (File name) as well. The default path for saved files follows:

```
\Program Files\Watlow\EZ-ZONE CONFIGURATOR\Saved Configurations
```

The user can save the file to any folder of choice.

Function Block Descriptions

Each of the next several pages graphically shows each of the RML function blocks. Note that as you view each you will find text that is black and text that appears gray. The gray text represents inputs that are not currently available based on the functions defined use (red text). For instance, when the defined use of the Analog Input function is set for RTD, TC Linearization will appear gray. Ranges specified are in units or degrees F, if expressed in degrees C, the range will be smaller.

Action Function

The Action Function will cause the action selected to occur when Source Function A = ON and Active Level = High. The active level specifies when the action occurs. A digital value that is high causes the action function when Active Level = High. A digital value that is low causes the action function when Active Level = Low. Based on a given input (Digital I/O, Event output, Logic function, etc), the Action function can cause other functions to occur. To name a few, starting and stopping a profile, silencing alarms, turn control loops off and placing alarms in non-alarm state.

Note:

Note: Action Function selection is module type and part number dependant.

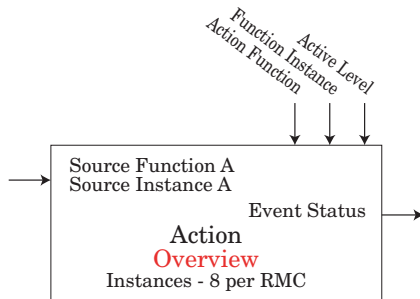

[\[ACT\] Action Menu](#)
[\[SET\] Setup Page](#)

- [F0]** Action Function : None, User Set Restore, Limit Reset*, Alarm, Silence Alarms, Control Loops Off and Alarms to Non-alarm State, Force Alarm to Occur, Idle Set Point, Tune, Manual, Switch Control Loop Off, Remote Set Point, TRU-TUNE+ Disable, Profile Disable, Profile Hold/Resume, Start Profile,
- [F1]** Function Instance : 0 to 25
- [SF0A]** Source Function A : None, Alarm, Compare, Counter, Digital I/O, Profile Event Out A to H, Function Key, Limit, Logic, Timer, Variable
- [SIA]** Source Instance A : 1 to 250
- [SZA]** Source Zone A : 0 to 16
- [LEU]** Active Level : High, Low

* Not available in firmware release 6.0 and above

[\[ACT\] Action Menu](#)
[\[OPER\] Operation Page](#)

- [E.S]** Event Status : On, Off

Alarm Function

The Alarm function will cause the output to change states when Alarm Source exceeds Alarm Set Points.

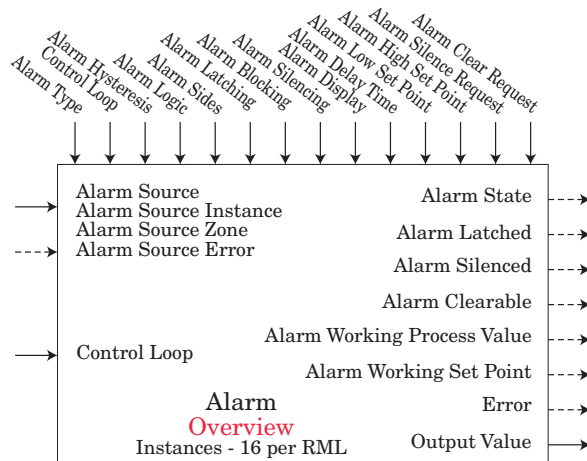

[\[ALM\] Alarm Menu](#)
[\[SEE\] Setup Page](#)

- [ATY]** Alarm Type : Off, Process
- [SRA]** Alarm Source : None, Analog Input, Current, Power, Linearization, Math, Process Value, Variable, Current Read
- [SIA]** Alarm Source Instance : 1 to 250
- [SZA]** Alarm Source Zone : 0 to 16
- [LOOP]** Control Loop : 1 to 4
- [RHY]** Alarm Hysteresis : 0.001 to 9,999.000
- [ALG]** Alarm Logic : Close on Alarm, Open on Alarm
- [ASD]** Alarm Sides : Both, High, Low
- [ALO]** Alarm Low Set Point : -1,999.000 to 9,999.000°F
- [AHI]** Alarm High Set Point : -1,999.000 to 9,999.000°F
- [ALL]** Alarm Latching : Non-Latching, Latching
- [ABL]** Alarm Blocking : Off, Startup, Set Point, Both
- [AS]** Alarm Silencing : Off, On
- [ADSP]** Alarm Display : Off, On
- [ADDL]** Alarm Delay Time : 0 to 9,999 seconds
- [ALCR]** Alarm Clear Request : 0
- [ASIR]** Alarm Silence Request : 0
- [ASE]** Alarm State: Startup, None, Blocked, Alarm Low, Alarm High, Error

[\[ALM\] Alarm Menu](#)
[\[OPER\] Operation Page](#)

- [ALO]** Alarm Low Set Point : -1,999.000 to 9,999.000
- [AHI]** Alarm High Set Point : -1,999.000 to 9,999.000

Alarm Clear Request : Ignore, Clear

Alarm Silence Request : Ignore, Silence

Alarm State : Startup, None, Blocked, Alarm Low, Alarm High, Error

Alarm Latched : No, Yes

Alarm Silenced : No, Yes

Alarm Clearable : No, Yes

Alarm Working Process Value : -1,999.000 to 9,999.000

Alarm Working Set Point : -1,999.000 to 9,999.000

Error : None, Open, Shorted, Measurement Error, Bad Cal Data, Ambient Error, Fail, Not Sourced

Output Value : On, Off

Analog Input Function

Note:

This Function configures and connects physical inputs to internal functions. Control Loop primary source instance must match Process Value or Analog Input instance.

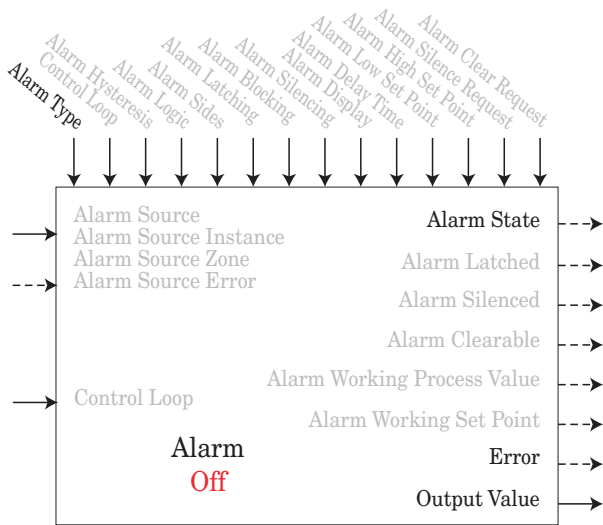

When function = Off THEN Output Value = OFF Alarm State = None Alarm Indication = None

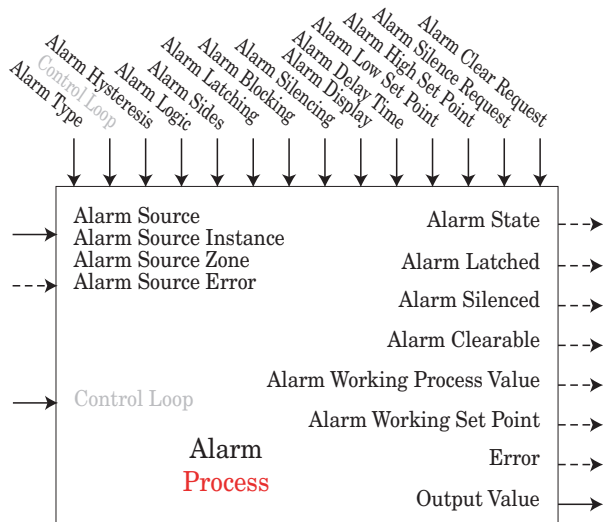

When function= Process THEN Alarm Variable = Process Value

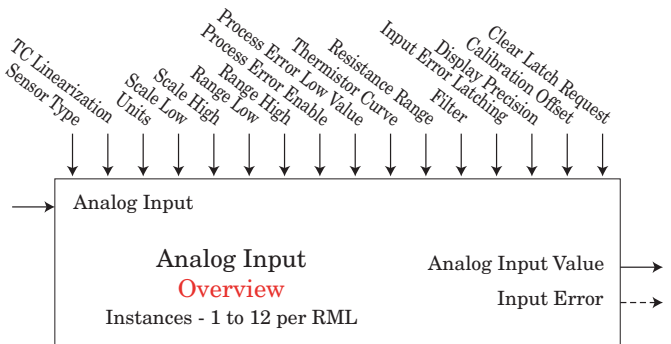

A Analog Input Menu
SEE Setup Page

- SEN** Sensor Type : Off, Thermocouple, Millivolts, Volts, Milliamps, RTD 100 Ohm, RTD 1000 Ohm, 1K Potentiometer, Thermistor (optional)
- rL** Number of RTD Leads: 2 or 3
- Lin** TC Linearization : B, C, D, E, F, J, K, N, R, S, T
- Unit** Units : Absolute Temperature, Power, Process, Relative Humidity
- SLo** Scale Low : -100.00 to 1000.00
- SHi** Scale High : -100.00 to 1000.00
- rLo** Range Low : -1,999.000 to 9,999.000
- rHi** Range High : -1,999.000 to 9,999.000
- PEE** Process Error Enable : Off, Low
- PEL** Process Error Low Value : -100.00 to 1,000.00
- TC** Thermistor Curve : Curve A, Curve B, Curve C, Custom
- RR** Resistance Range : 5k, 10k, 20k, 40k
- FiL** Filter : 0.0 to 60.0 seconds
- iEr** Input Error Latching : Off, On
- dEC** Display Precision : Whole, Tenths, Hundredths, Thousandths
- iCR** Calibration Offset : -1,999.000 to 9,999.000
- AIn** Analog Input Value : -1,999.000 to 9,999.000

A Analog Input Menu
OPER Operation Page

- AIn** Analog Input Value : -1,999.000 to 9,999.000
- iEr** Input Error : None, Open, Shorted, Measurement Error, Bad Cal Data, Ambient Error, RTD Error, Fail, Not Sourced
- iCR** Calibration Offset : -1,999.000 to 9,999.000

Clear Latch Request : Clear, Ignore

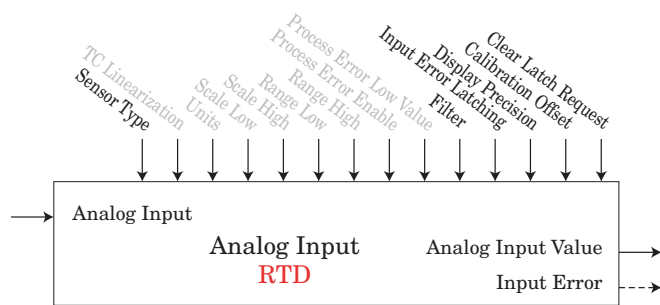
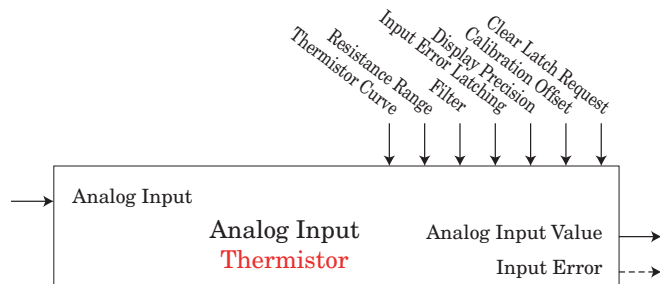
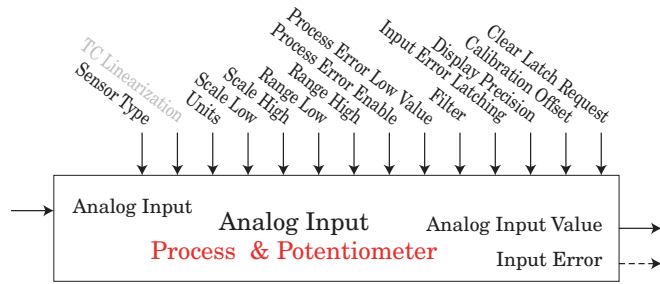
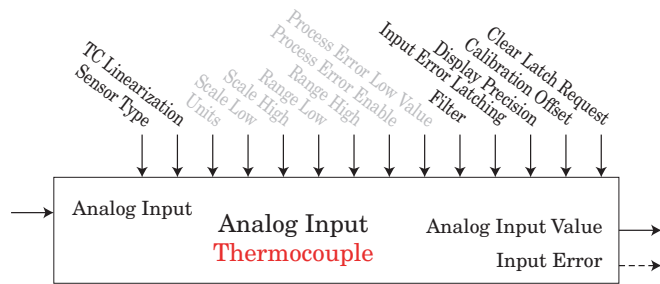
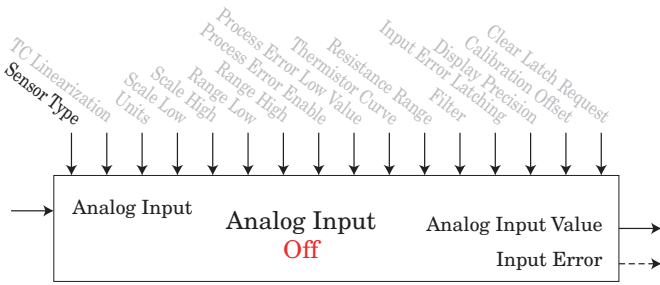

Compare Function

An error, when read, can indicate any of the following: None, Open, Shorted, Measurement Error, Bad Cal Data, Ambient Error, RTD Error, Fail, Math Error, Not Sourced, Stale

Tolerance is expressed in the same units as Source A. For the function to work properly Source A and Source B must be without errors.

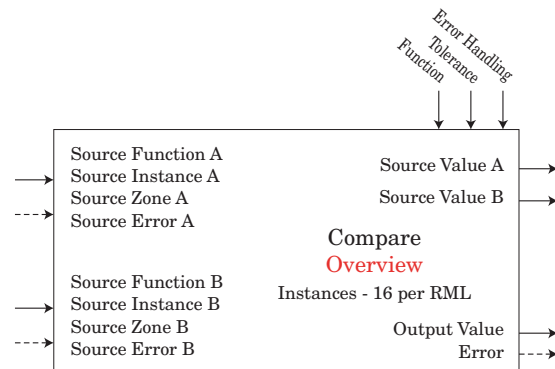

[CPE] Compare Menu
[SEE] Setup Page

- Fn** Function : Off, Greater Than, Less Than, Equal To, Not Equal To,
- tol** Tolerance : 0.0 to 9,999.000 units or F
- SFnA** Source Function A : None, Analog Input, Current, Cool Power, Heat Power, Power, Linearization, Math, Process Value, Set Point Closed, Set Point Open, Variable
- SA** Source Instance A : 1 to 250
- SZA** Source Zone A : 0 to 16
- SFnB** Source Function B : None, Analog Input, Current, Cool Power, Heat Power, Power, Linearization, Math, Process Value, Set Point Closed, Set Point Open, Variable
- SB** Source Instance B : 1 to 250
- SZB** Source Zone B : 0 to 16
- Erh** Error Handling : False Bad, False Good, True Bad, True Good

[CPE] Compare Menu
[OPER] Operation Page

- SA** Source Value A : -1,999.000 to 9,999.000 units or F
- SB** Source Value B : -1,999.000 to 9,999.000 units or F
- ow** Output Value : Off, On

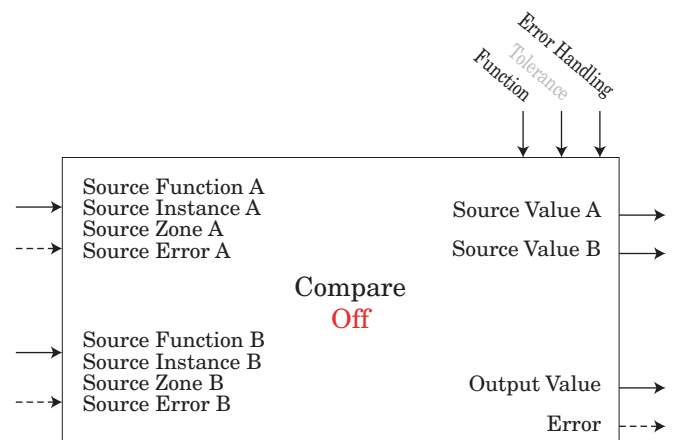

No Compare, Output Value = OFF

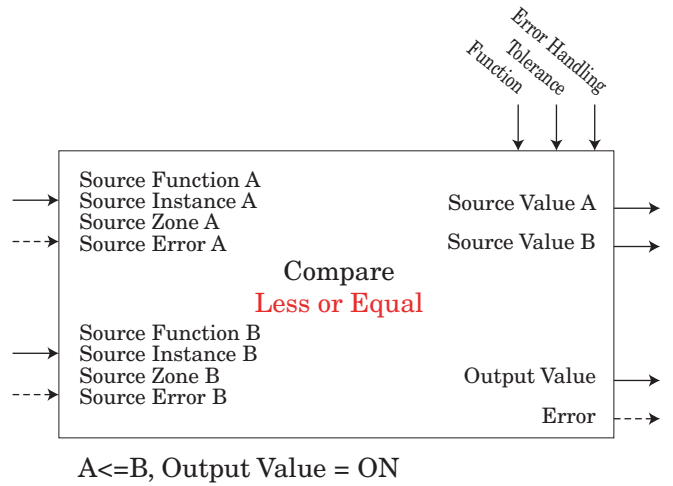
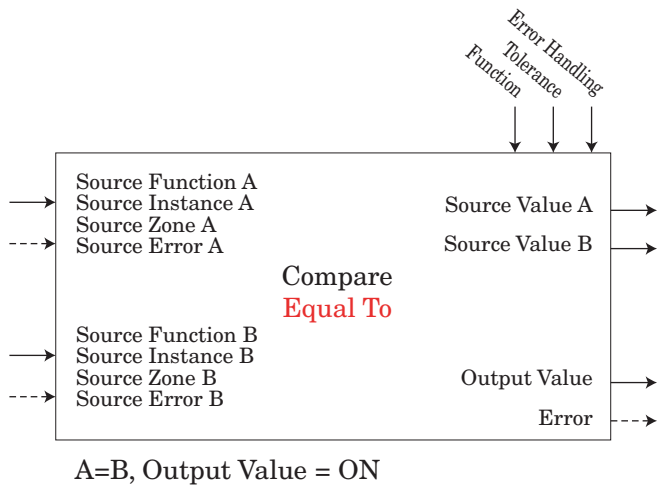
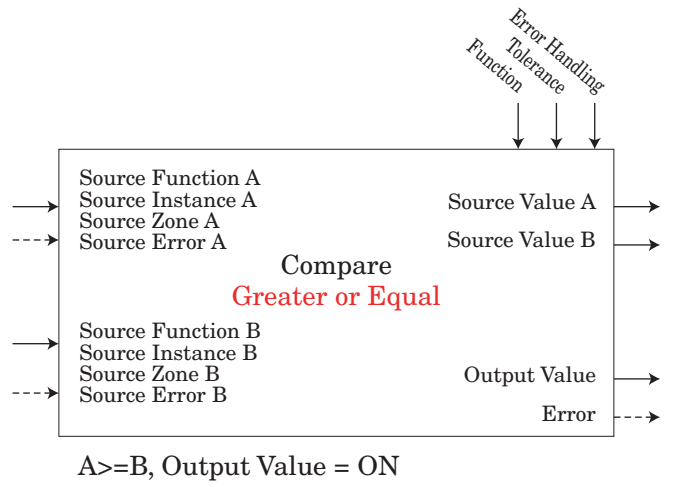
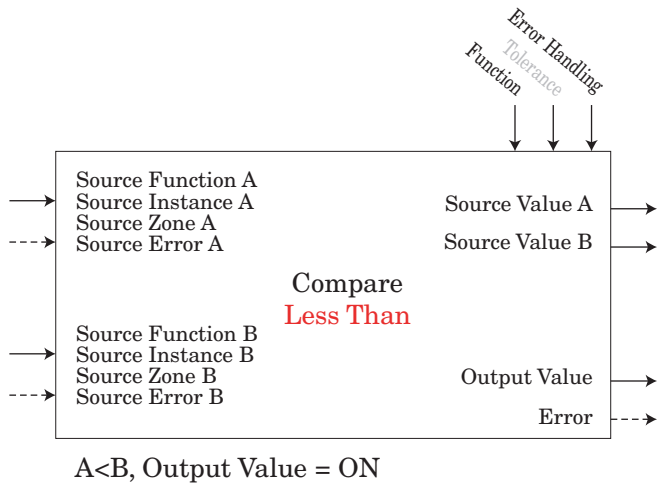
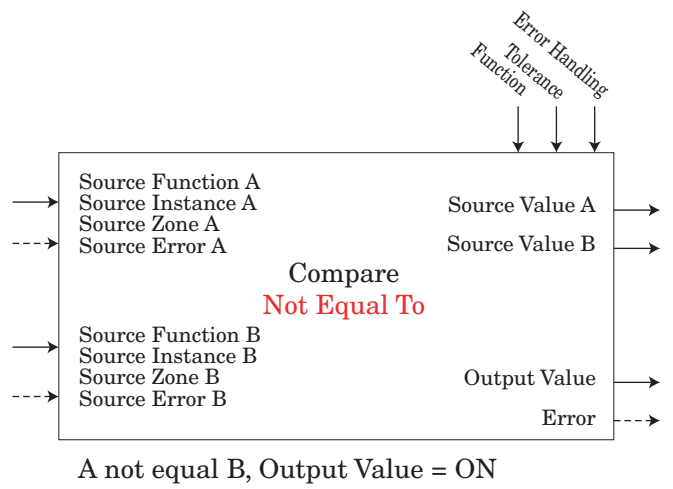
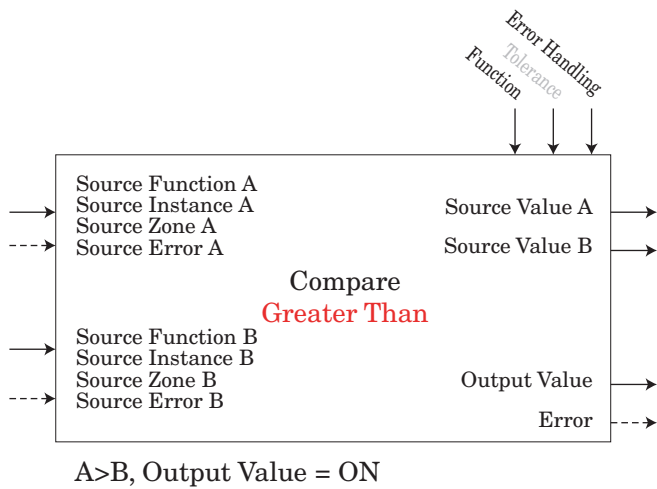

Counter Function

Function counts up or down from Load Value and produces Output Value = On when Count = Target Value.

Note:

- Count value clears on power loss.
- Load Value restored on power up.

Counter Operation:

Whenever a prescribed clock transition occurs without an error on source B the count will be equal to the Load Value.

If Function is an Up Counter:

Whenever a prescribed clock transition occurs without an error on Source A the count will increment by +1. If the count is equal to 9,999 when the transition occurs count will be 1 after transition.

If Function is a Down Counter:

Whenever a prescribed clock transition occurs without an error on Source A the count will decrement by -1. If the count is equal to 0 when the transition occurs the count will be 9,999 after transition.

An error, when read, can indicate any of the following:
None, Open, Shorted, Measurement Error, Bad Cal Data, Ambient Error, RTD Error, Fail, Math Error, Not Sourced, Stale

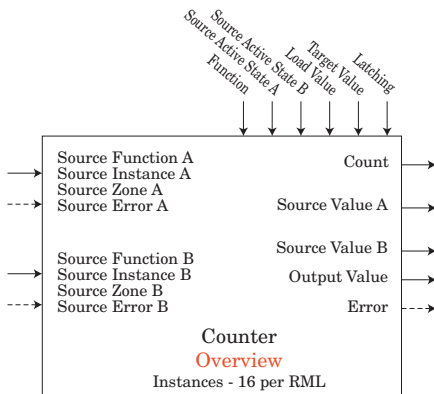

[CtF] Counter Menu
[SEt] Setup Page

[Fn]	Function : Up, Down
[5FnA]	Source Function A : None, Alarm, Compare, Counter, Digital I/O, Profile Event Out A to H, Function Key, Logic, Timer, Variable
[5iA]	Source Instance A : 1 to 250
[5zA]	Source Zone A : 0 to 16
[5ASA]	Source Active State A (Active State Clock) : High (rising), Low (falling), Both (rising & falling)
[5FnB]	Source Function B : None, Alarm, Compare, Counter, Digital I/O, Profile Event Out A to H, Function Key, Logic, Timer, Variable
[5iB]	Source Instance B : 1 to 250
[5zB]	Source Zone B : 0 to 16
[5ASB]	Source Active State B (Active State Load) : High, Low
[LdV]	Load Value : 0 to 9,999
[TgV]	Target Value : 0 to 9,999
[Lch]	Latching : No, Yes

[CtF] Counter Menu
[SEt] Operation Page

[Cnt]	Count : 0 to 9,999
[SvA]	Source Value A : Off, On
[SvB]	Source Value B : Off, On
[Ov]	Output Value : Off, On

Custom Function

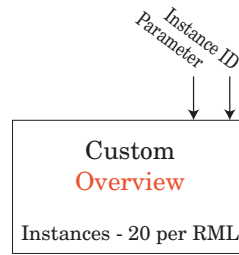

[CUSE] Custom Menu
[FRct] Factory Page

[PAR]	Parameter : None, Process, Calibration Offset, Display Units, User Settings Restore, Alarm Low Set Point, Alarm High Set Point, Alarm Hysteresis, Set Point, Active Process Value, Active Set Point, Open-Loop Set Point, Autotune, Control Mode, Heat Power, Cool Power, Time Integral, Time Derivative, Dead band, Heat Proportional Band, Heat Hysteresis, Cool Proportional Band, Cool Hysteresis, Ramp Rate, TRU-TUNE+ Enable, Idle Set Point, Custom, Profile Start, Profile Action Request, Guaranteed Soak Deviation Value, Current, Limit Low Set Point, Limit High Set Point, Limit Hysteresis, Limit Status
[iID]	Instance ID : 1 to 24

Diagnostic Function

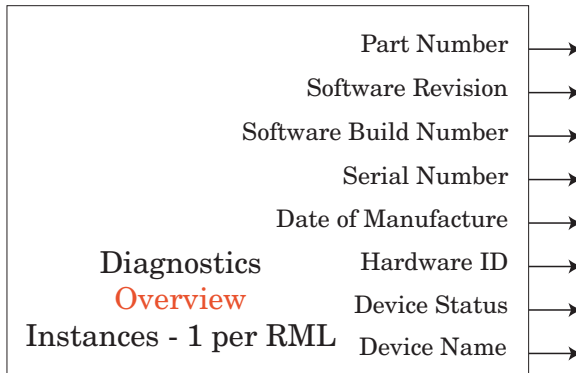

[d,19] Diagnostics Menu
[FRct] Factory Page

[Pn]	Part Number: scrolls on display
[rEv]	Software Revision: 1.00, ...
[5bLd]	Software Build Number : 0, 1, 2, ...
[5n]	Serial Number : xxxxxx
[dAEE]	Date of Manufacture : YWW format

Hardware ID : 114 (RML)

Device Status : OK, Fail

Device Name : EZ-ZONE RM

Digital Input/Output Function

Note:

Input Value is passed to either profile event inputs or action function blocks.
Output Value determined by Source A and Digital Output Function.

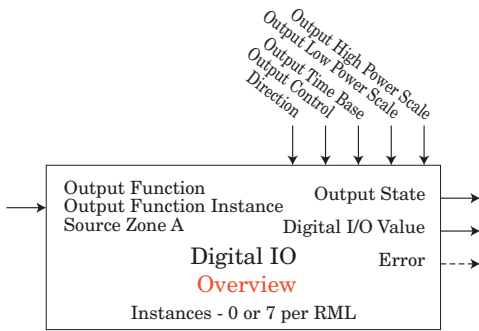

d.i.a Digital I/O Menu
SEE Setup Page

- d.i.r** Direction : Output, Input Voltage, Input Dry Contact
- F.n** Output Function : Off, Analog Input, Alarm, Cool Power, Heat Power, Compare, Counter, Digital I/O, Profile Event Out A to H, Function Key, Logic, Linearization, Math, Process Value, Special Function Output 1 to 4, Timer, Variable
- F.i** Output Function Instance : 1 to 250
- S.Z.A** Source Zone A : 0 to 16
- a.c.t** Output Control : Fixed Time Base, Variable Time Base
- a.t.b** Output Time Base : 0.1 to 60.0 seconds
- a.l.o** Output Low Power Scale : 0.0 to 100.0 %
- a.h.i** Output High Power Scale : 0.0 to 100.0 %

d.i.a Digital I/O Menu
SEE Operation Page

- d.i.s** Input State : On, Off
- d.o.s** Output State : On, Off

Digital Input Value : On, Off

An error, when read, can indicate any of the following:
 None, Open, Shorted, Measurement Error, Bad Cal Data, Ambient Error, RTD Error, Fail, Math Error, Not Sourced, Stale

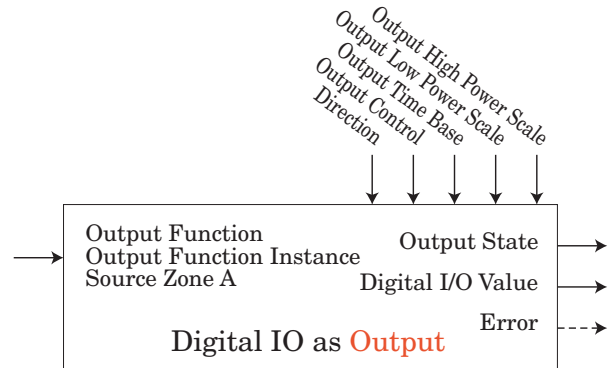
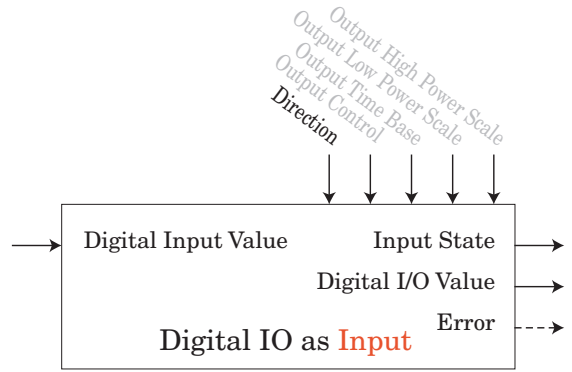

Global Function

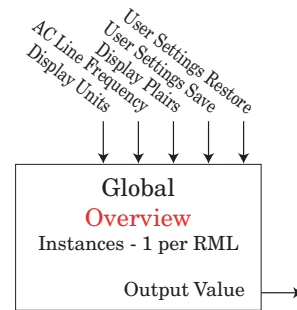

GLbL Global Menu
SEE Setup Page

- C.F** Display Units : F, C
- ACLF** AC Line Frequency : 50 Hz, 60 Hz
- dP.r.S** Display Pairs : 1 to 10
- US.r.S** User Settings Save : None, User Set 1, User Set 2*
- US.r.r** User Settings Restore : None, User Set 1, User Set 2, Factory

* Starting with firmware release 6, there is only one User Set.

Limit Function

This function uses a dedicated input and the output will change state when Source A exceeds limit set points. The limit, when tripped, must be manually cleared to reset the output and clear the message. The Analog Input and mechanical relay output are dedicated to each limit loop and are located in same module.

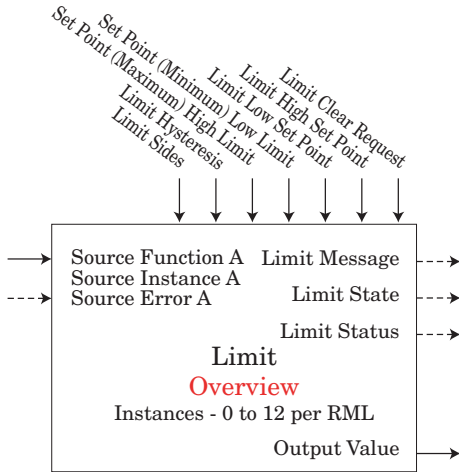

[\[L.P.7\] Limit Menu](#)
[\[S.E.E\] Setup Page](#)

- [\[L.S.D\]](#) Limit Sides : Both, High, Low
- [\[L.H.Y\]](#) Limit Hysteresis : 0.001 to 9,999.000
- [\[S.P.L.H\]](#) Set Point (Maximum) High Limit : -1,999.000 to 9,999.000
- [\[S.P.L.L\]](#) Set Point (Minimum) Low Limit : -1,999.000 to 9,999.000
- [\[L.H.S\]](#) Limit High Set Point : -1,999.000 to 9,999.000
- [\[L.L.S\]](#) Limit Low Set Point: -1,999.000 to 9,999.000
- [\[S.F.N.A\]](#) Source Function: None, Digital I/O, Function Key, Variable
- [\[S.I.A\]](#) Source Instance: 1 to 250
- [\[S.Z.A\]](#) Source Zone: 0 to 16
- [\[L.C.R\]](#) Limit Clear Request: Ignore or Clear
- [\[L.S.E\]](#) Limit State: Off, None, Limit High, Limit Low, Error

[\[L.P.7\] Limit Menu](#)
[\[O.P.E.R\] Operation Page](#)

- [\[L.L.S\]](#) Limit Low Set Point : -1,999.000 to 9,999.000
- [\[L.H.S\]](#) Limit High Set Point : -1,999.000 to 9,999.000
- [\[L.C.R\]](#) Limit Clear Request
- [\[L.S.E\]](#) Limit State: Off, None, Limit High, Limit Low, Error

Linearization Function

This function will take an analog Source A and re-linearize using a 10-point offset, then add Offset and produce an Output Value.

An error, when read, can indicate any of the following: None, Open, Shorted, Measurement Error, Bad Cal Data, Ambient Error, RTD Error, Fail, Math Error, Not Sourced, Stale

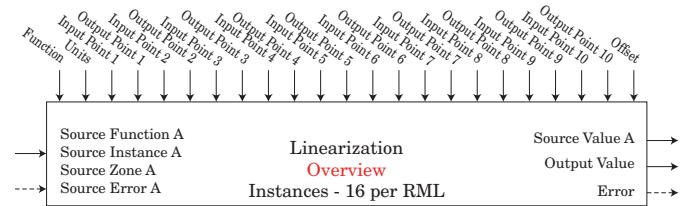

[\[L.N.R\] Linearization](#)
[\[S.E.E\] Setup Page](#)

- [\[F.N\]](#) Function : Off, Interpolated, Stepped
- [\[S.F.N.A\]](#) Source Function A : None, Analog Input, Current, Cool Power, Heat Power, Power, Linearization, Math, Process Value, Set Point Closed, Set Point Open, Variable
- [\[S.I.A\]](#) Source Instance A : 1 to 250
- [\[S.Z.A\]](#) Source Zone A : 0 to 16
- [\[U.N.I.T\]](#) Units : Source, None, Absolute Temperature, Relative Temperature, Power, Process, Relative Humidity
- [\[I.P.1\]](#) Input Point 1 : -1,999.000 to 9,999.000
- [\[O.P.1\]](#) Output Point 1 : -1,999.000 to 9,999.000
- [\[I.P.2\]](#) Input Point 2 : -1,999.000 to 9,999.000
- [\[O.P.2\]](#) Output Point 2 : -1,999.000 to 9,999.000
- [\[I.P.3\]](#) Input Point 3 : -1,999.000 to 9,999.000
- [\[O.P.3\]](#) Output Point 3 : -1,999.000 to 9,999.000
- [\[I.P.4\]](#) Input Point 4 : -1,999.000 to 9,999.000
- [\[O.P.4\]](#) Output Point 4 : -1,999.000 to 9,999.000
- [\[I.P.5\]](#) Input Point 5 : -1,999.000 to 9,999.000
- [\[O.P.5\]](#) Output Point 5 : -1,999.000 to 9,999.000
- [\[I.P.6\]](#) Input Point 6 : -1,999.000 to 9,999.000
- [\[O.P.6\]](#) Output Point 6 : -1,999.000 to 9,999.000
- [\[I.P.7\]](#) Input Point 7 : -1,999.000 to 9,999.000
- [\[O.P.7\]](#) Output Point 7 : -1,999.000 to 9,999.000
- [\[I.P.8\]](#) Input Point 8 : -1,999.000 to 9,999.000
- [\[O.P.8\]](#) Output Point 8 : -1,999.000 to 9,999.000
- [\[I.P.9\]](#) Input Point 9 : -1,999.000 to 9,999.000
- [\[O.P.9\]](#) Output Point 9 : -1,999.000 to 9,999.000
- [\[I.P.10\]](#) Input Point 10 : -1,999.000 to 9,999.000
- [\[O.P.10\]](#) Output Point 10 : -1,999.000 to 9,999.000

[\[L.N.R\] Linearization Menu](#)
[\[O.P.E.R\] Operation Page](#)

- [\[S.V.A\]](#) Source Value A : -1,999.000 to 9,999.000
- [\[O.F.S.E.T\]](#) Offset : -1,999.000 to 9,999.000
- [\[O.V.\]](#) Output Value : -1,999.000 to 9,999.000

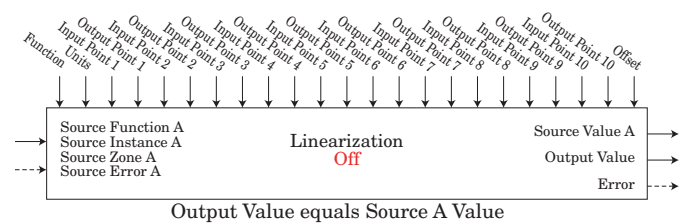

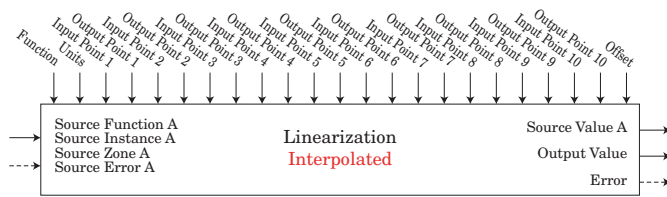

IF Source A < Input Point 1 THEN Output Value = Output Point 1 + Offset
 ELSE WHILE ((Source A > Input Point n) AND (Input Point n < Input Point n+1)) n = n+1 UNTIL n is largest valid value. IF ((Source A >= Input Point n-1) AND (Input Value < Input Point n)) THEN Output Value = (Source A - Input Point n-1) * (Output Point n - Output Point n-1) / (Input Point n - Input Point n-1) + Output Point n-1 + Offset ELSE Output Value = Output Point n + Offset WHERE n = 1 to 10

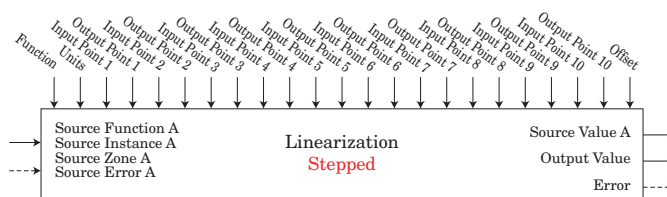

WHILE (Source A < Input Point n) n = n+1 FROM n = 2 UNTIL n is largest valid value
 Output Value = Output Point n-1 + Offset
 Note: if Source A < Input Point 2 then Output Value = Output Point 1; if Source A < Input Point 3 then out = Output Point 2; etc If Source A > last Input Point the Output Value = last Output Point.
 The list of Input Point values are assumed to be in increasing order. If Input Point n < Input Point n-1 THEN Output Value = Output Point n-1

Logic Function

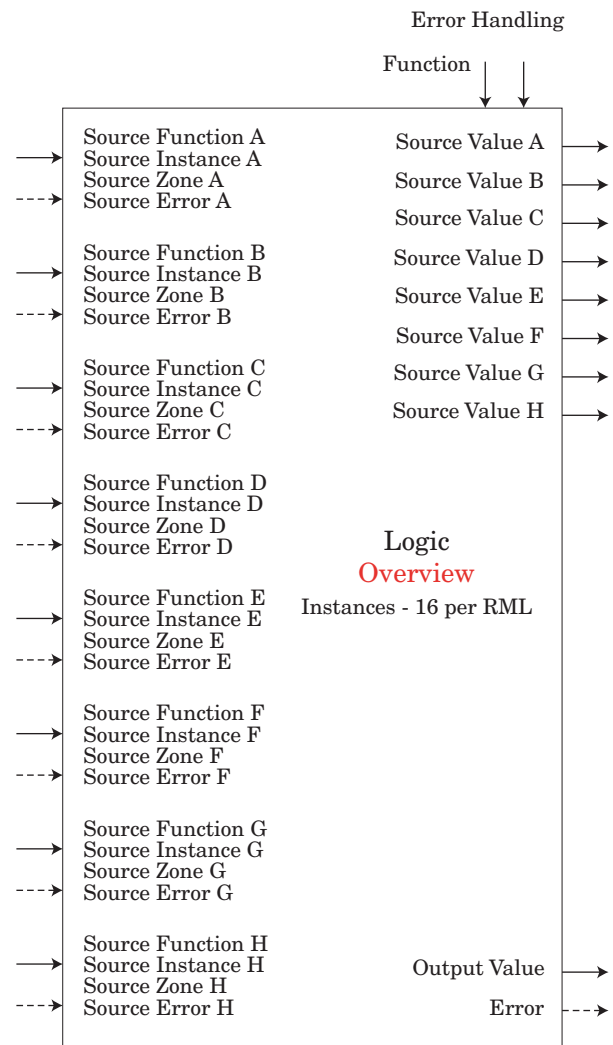

An error, when read, can indicate any of the following:
 None, Open, Shorted, Measurement Error, Bad Cal Data, Ambient Error, RTD Error, Fail, Math Error, Not Sourced, Stale

- Fn** Function : Off, AND, OR, Equal To, NAND, NOR, Not Equal To, Latch, RS Flip Flop
- SFnA** Source Function A : None, Alarm, Compare, Counter, Digital I/O, Profile Event Out A to H, Function Key, Limit, Logic, Special Function Output 1 to 4, Timer, Variable
- S*a*A** Source Instance A : 1 to 250
- S*z*A** Source Zone A : 0 to 16
- SFnB** Source Function B : None, Alarm, Compare, Counter, Digital I/O, Profile Event Out A to H, Function Key, Limit, Logic, Special Function Output 1 to 4, Timer, Variable
- S*a*B** Source Instance B : 1 to 250
- S*z*B** Source Zone B : 0 to 16
- SFnC** Source Function C : None, Alarm, Compare, Counter, Digital I/O, Profile Event Out A to H, Function Key, Limit, Logic, Special Function Output 1 to 4, Timer, Variable
- S*a*C** Source Instance C : 1 to 250
- S*z*C** Source Zone C : 0 to 16
- SFnD** Source Function D : None, Alarm, Compare, Counter, Digital I/O, Profile Event Out A to H, Function Key, Limit, Logic, Special Function Output 1 to 4, Timer, Variable
- S*a*D** Source Instance D : 1 to 250
- S*z*D** Source Zone D : 0 to 16
- SFnE** Source Function E : None, Alarm, Compare, Counter, Digital I/O, Profile Event Out A to H, Function Key, Limit, Logic, Special Function Output 1 to 4, Timer, Variable
- S*a*E** Source Instance E : 1 to 250
- S*z*E** Source Zone E : 0 to 16
- SFnF** Source Function F : None, Alarm, Compare, Counter, Digital I/O, Profile Event Out A to H, Function Key, Limit, Logic, Special Function Output 1 to 4, Timer, Variable
- S*a*F** Source Instance F : 1 to 250
- S*z*F** Source Zone F : 0 to 16
- SFnG** Source Function G : None, Alarm, Compare, Counter, Digital I/O, Profile Event Out A to H, Function Key, Limit, Logic, Special Function Output 1 to 4, Timer, Variable
- S*a*G** Source Instance G : 1 to 250
- S*z*G** Source Zone G : 0 to 16
- SFnH** Source Function H : None, Alarm, Compare, Counter, Digital I/O, Profile Event Out A to H, Function Key, Limit, Logic, Special Function Output 1 to 4, Timer, Variable
- S*a*H** Source Instance H : 1 to 250
- S*z*H** Source Zone H : 0 to 16
- Erh** Error Handling : True Good, True Bad, False Good, False Bad

- S*va*A** Source Value A : Off, On
- S*vb*B** Source Value B : Off, On
- S*vc*C** Source Value C : Off, On
- S*vd*D** Source Value D : Off, On
- S*ve*E** Source Value E : Off, On
- S*vf*F** Source Value F : Off, On
- S*vg*G** Source Value G : Off, On
- S*vh*H** Source Value H : Off, On
- o*u*** Output Value : Off, On

Function ↓ Error Handling ↓

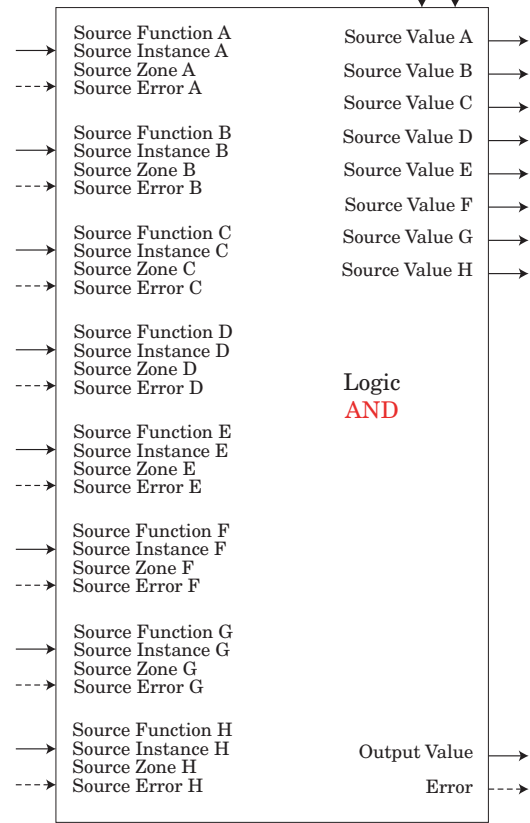

$$A * B * C * D * E * F * G * H = ON$$

Function ↓ Error Handling ↓

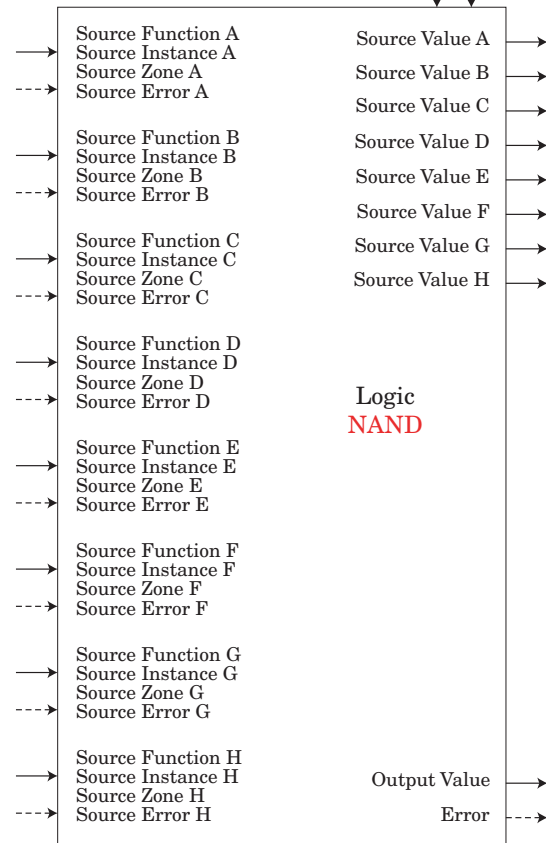

$$A * B * C * D * E * F * G * \bar{H} = ON$$

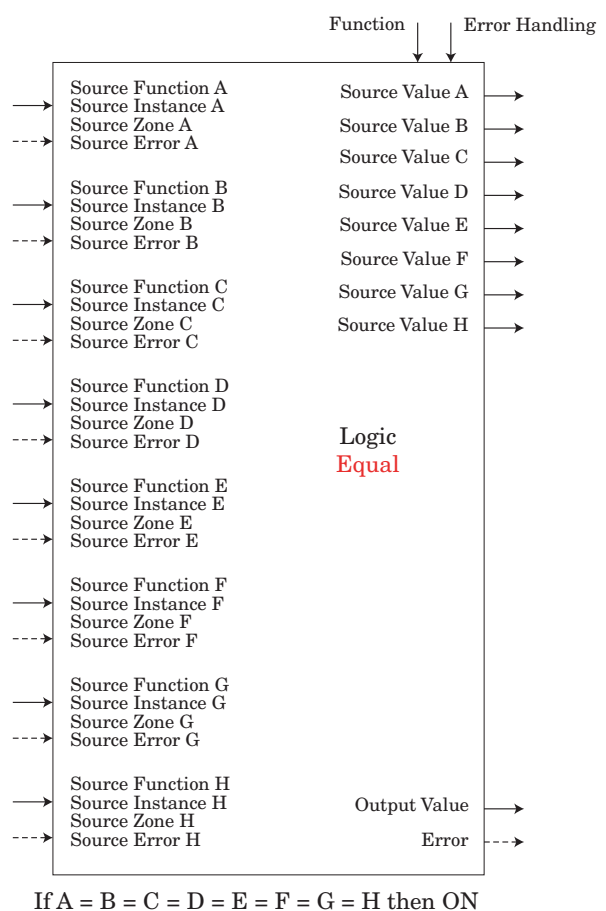
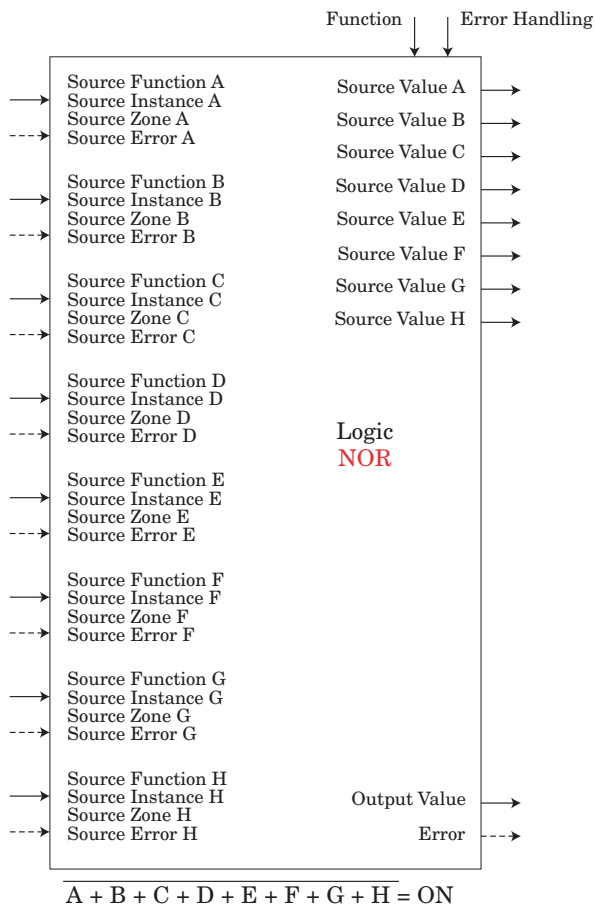
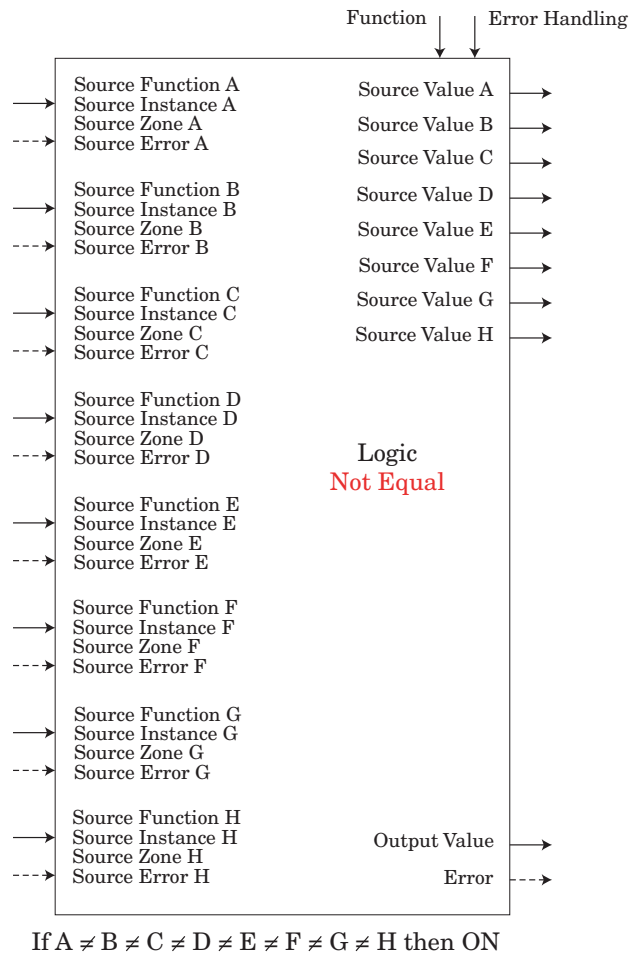
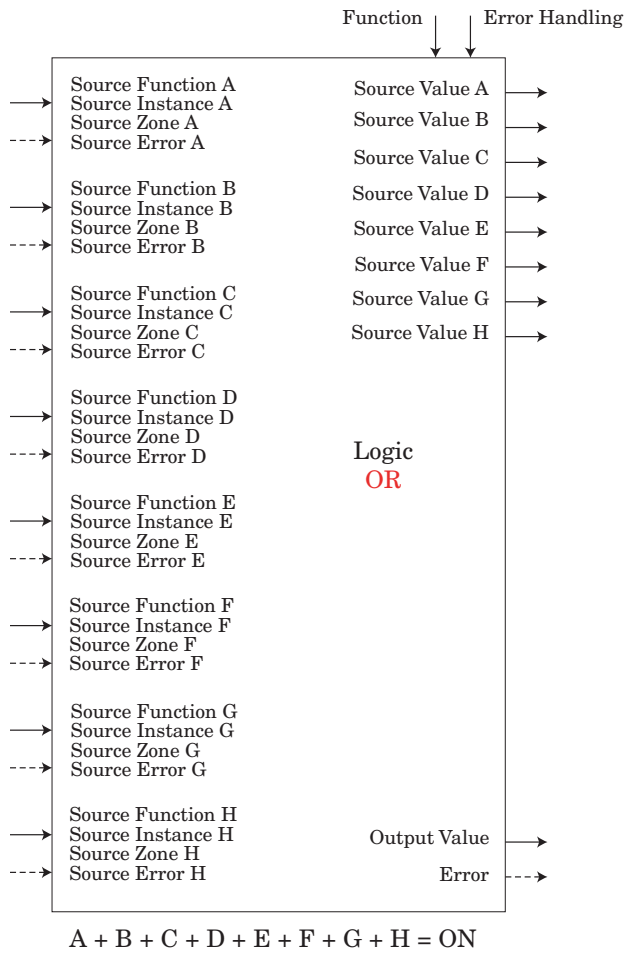

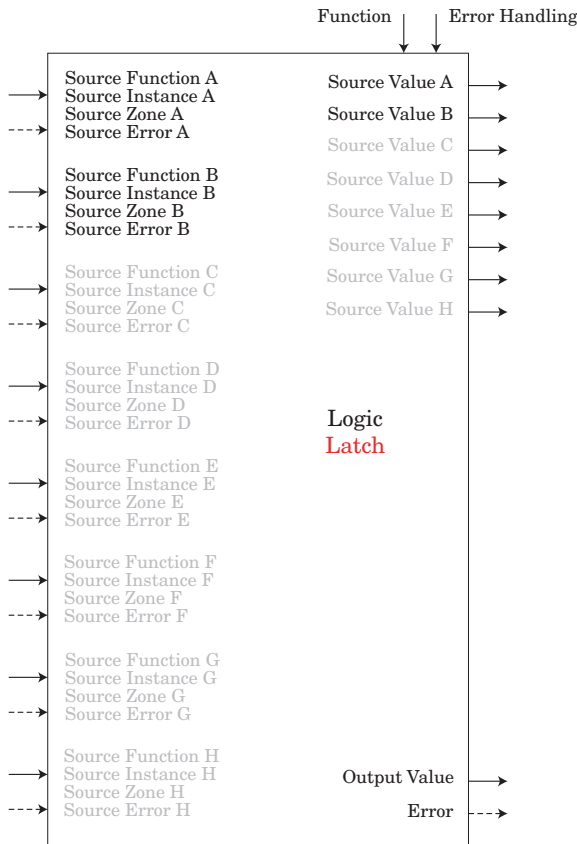

Output Value follows A, unless B = ON
Latch Output while B = ON

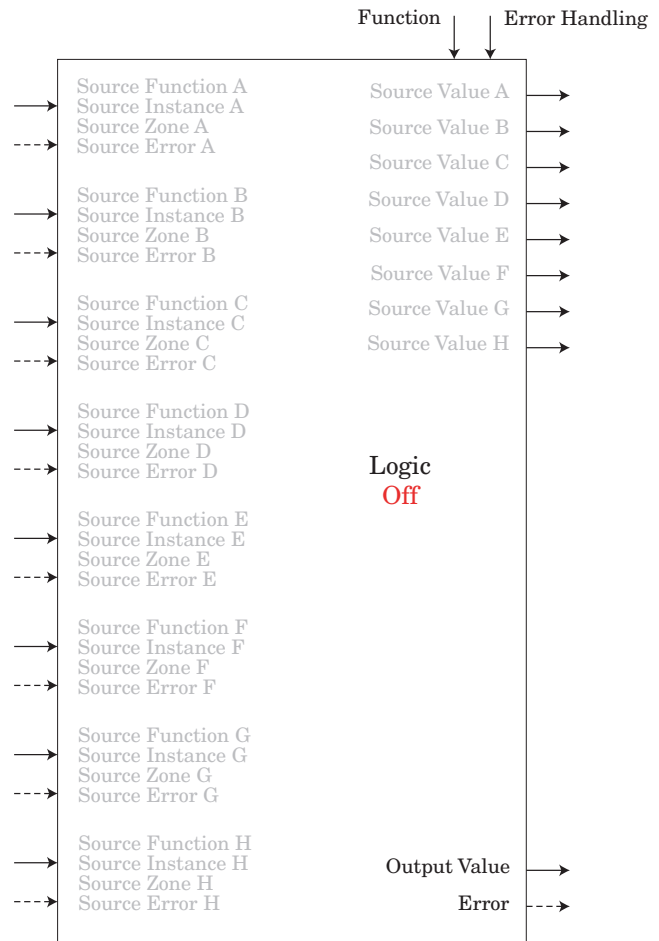

Output Value = Off

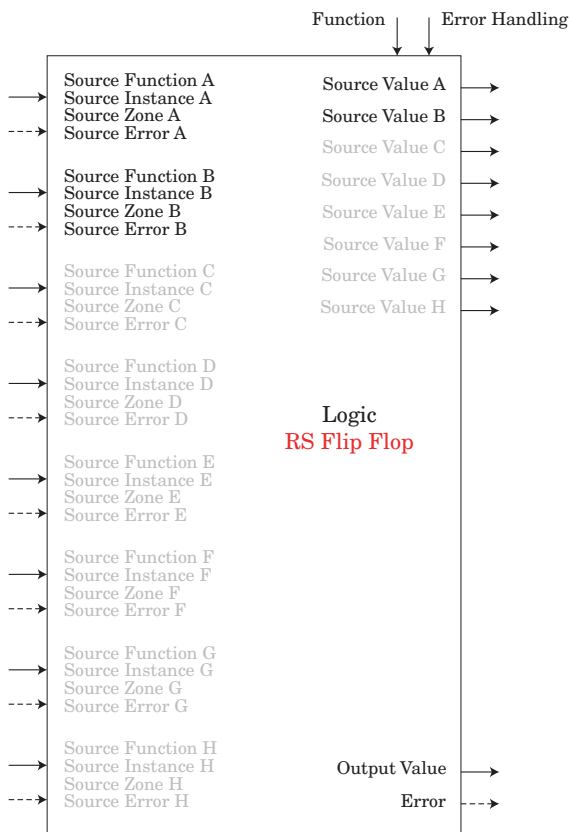

- A Sets Output Value ON
- B Resets Output Value OFF

Math Function

The Math function block accepts up to 4 Analog Inputs and performs a programmed math function to derive an output value with Filter and Offset values applied. One digital input is used for enabling or disabling Process and Deviation Scale and some math operations must be performed in the user's units.

Functions may combine multiple inputs. Those inputs may have incompatible units from a logical point of view. As a result, unless otherwise indicated, the presentation of the output value is the same as Source A. This accommodates temperatures being multiplied, divided and offset by constants and process inputs.

Only inputs pointed to a source are used in the calculations.

An error, when read, can indicate any of the following:
None, Open, Shorted, Measurement Error, Bad Cal Data, Ambient Error, RTD Error, Fail, Math Error, Not Sourced, Stale

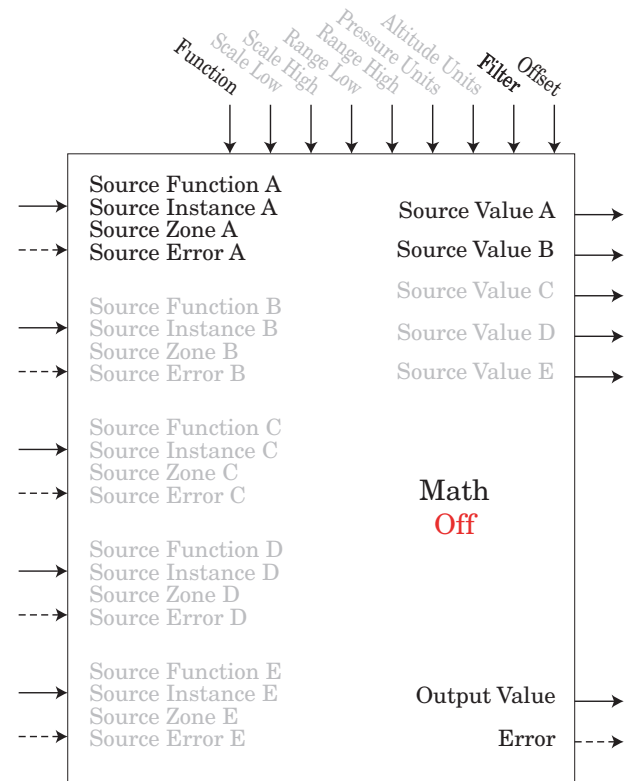
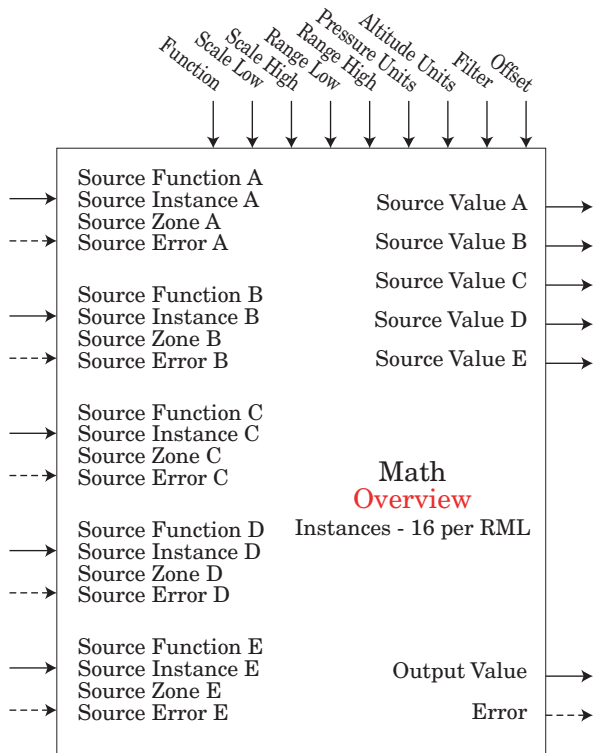

Output Value = Filter [A + Offset]
 Display units follows Source A

- Math Menu**
Setup Page
- F_n** Function : Off, Average, Process Scale, Deviation Scale, Switch Over, Differential, Ratio, Add, Multiply, Absolute Difference, Minimum, Maximum, Square Root, Sample and Hold, Pressure to Altitude, Dewpoint
 - SF_{nA}** Source Function A : None, Analog Input, Current, Cool Power, Heat Power, Power, Linearization, Math, Process Value, Set Point Closed, Set Point Open, Variable
 - S_IA** Source Instance A : 1 to 250
 - S_ZA** Source Zone A : 0 to 16
 - SF_{nB}** Source Function B : None, Analog Input, Current, Cool Power, Heat Power, Power, Linearization, Math, Process Value, Set Point Closed, Set Point Open, Variable
 - S_IB** Source Instance B : 1 to 250
 - S_ZB** Source Zone B : 0 to 16
 - SF_{nC}** Source Function C : None, Analog Input, Current, Cool Power, Heat Power, Power, Linearization, Math, Process Value, Set Point Closed, Set Point Open, Variable
 - S_IC** Source Instance C : 1 to 250
 - S_ZC** Source Zone C : 0 to 16
 - SF_{nD}** Source Function D : None, Analog Input, Current, Cool Power, Heat Power, Power, Linearization, Math, Process Value, Set Point Closed, Set Point Open, Variable
 - S_ID** Source Instance D : 1 to 250
 - S_ZD** Source Zone D : 0 to 16
 - SF_{nE}** Source Function E : None, Alarm, Compare, Counter, Digital I/O, Profile Event Out A to H, Function Key, Logic, Timer, Variable
 - S_IE** Source Instance E : 1 to 250
 - S_ZE** Source Zone E : 0 to 16
 - S_L** Scale Low : -1,999.0 to 9,999.0
 - S_H** Scale High : -1,999.0 to 9,999.0
 - U_n | k** Units : Source, None, Absolute Temperature, Relative Temperature, Power, Process, Relative Humidity
 - r_L | o** Range Low : -1,999.0 to 9,999.0
 - r_H | i** Range High : -1,999.0 to 9,999.0
 - P_u | k** Pressure Units : PSI, Torr, mBar, Atmosphere, Pascal
 - A_l | t** Altitude Units : Feet, Kilofeet
 - F_i | L** Filter : 0.0 to 60.0 seconds

Math Menu
Operation Page

- S_vA** Source Value A : -1,999.000 to 9,999.000
- S_vB** Source Value B : -1,999.000 to 9,999.000
- S_vC** Source Value C : -1,999.000 to 9,999.000
- S_vD** Source Value D : -1,999.000 to 9,999.000
- S_vE** Source Value E : Off, On
- o_v** Output Value : -1,999.000 to 9,999.000
- o_f | s_e** Offset : -1,999.000 to 9,999.000

Error : None, Open, Shorted, Measurement Error, Bad Cal Data, Ambient Error, RTD Error, Fail, Math Error, Not Sourced, Stale

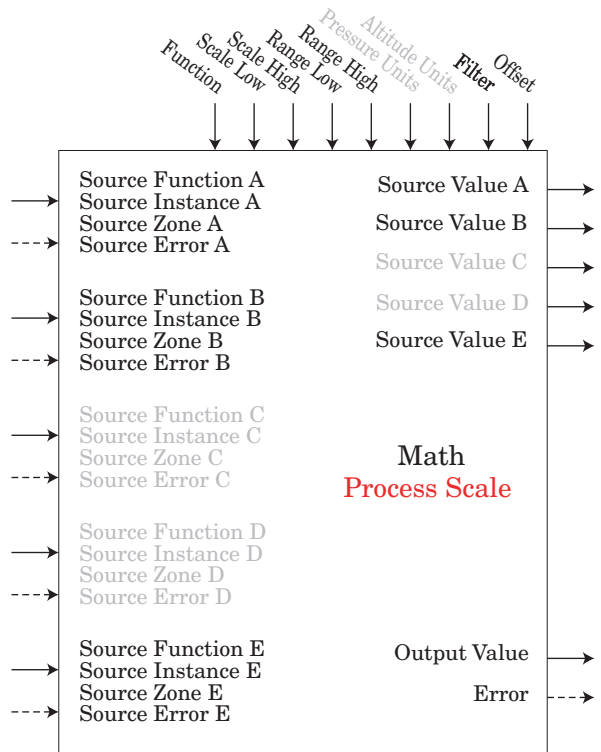

If E = OFF, Output Value = Filter [(Range High - Range Low) / (Scale High - Scale Low) * (A - Scale Low) + Range Low + Offset] If E = ON, Output Value = Filter [B + Offset] Scale Low/High and Range Low/High follows Source A display units.

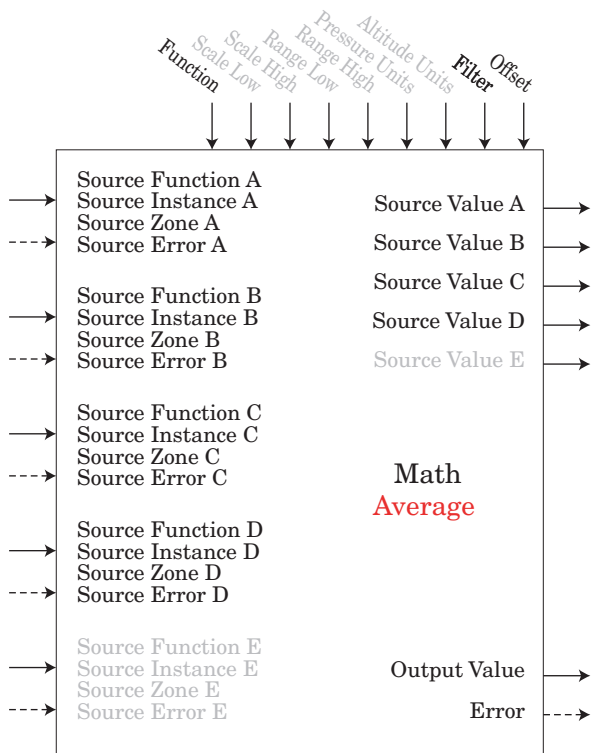

Output Value = Filter [(Average (A + B + C + D)) + Offset] Display units follows the last source that is temperature else follow Source A

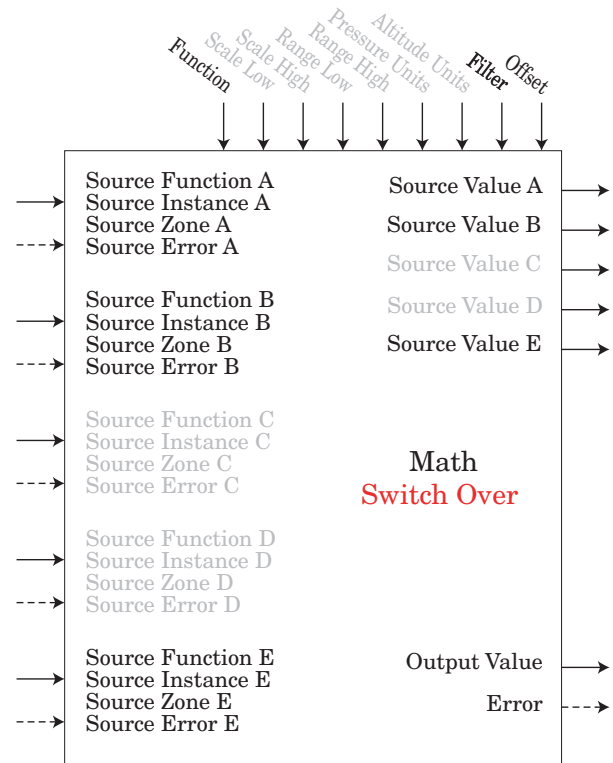

If E = OFF, Output Value = Filter [A + Offset] If E = ON, Output Value = Filter [B + Offset] Display units follows active source.

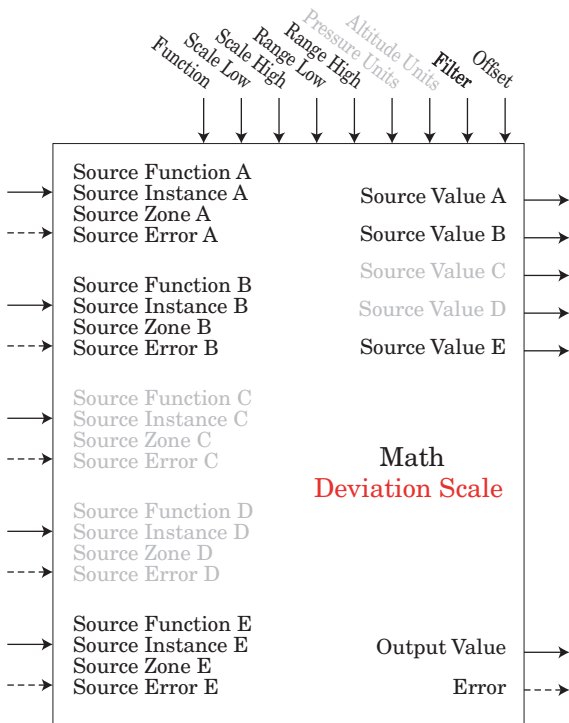

If E = OFF, Output Value = Filter [(((Range High - Range Low) / (Scale High - Scale Low)) * (A - Scale Low) + Range Low + B + Offset)] If E = ON, Output Value = Filter [B + Offset] Scale Low/High and Range Low/High follows Source A display units.

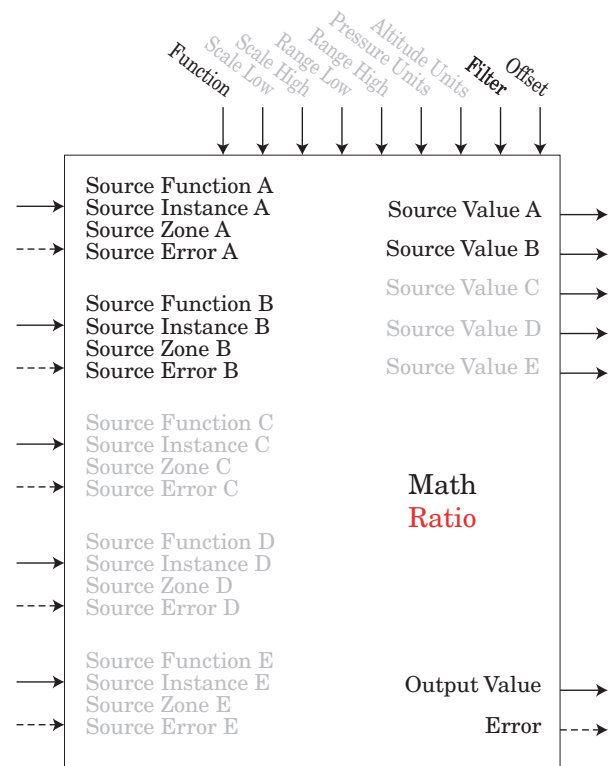

Output Value = Filter [(A / B) + Offset] If display units of Source A = Source B, no display units on output value, else follow Source A

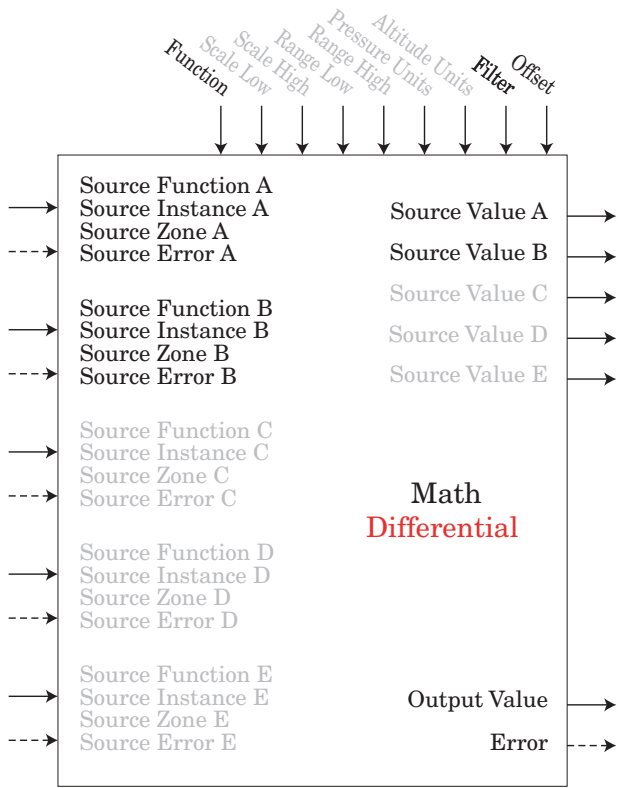

Output Value = Filter [(A - B) + Offset]
Display units follows Source A plus relative Source B

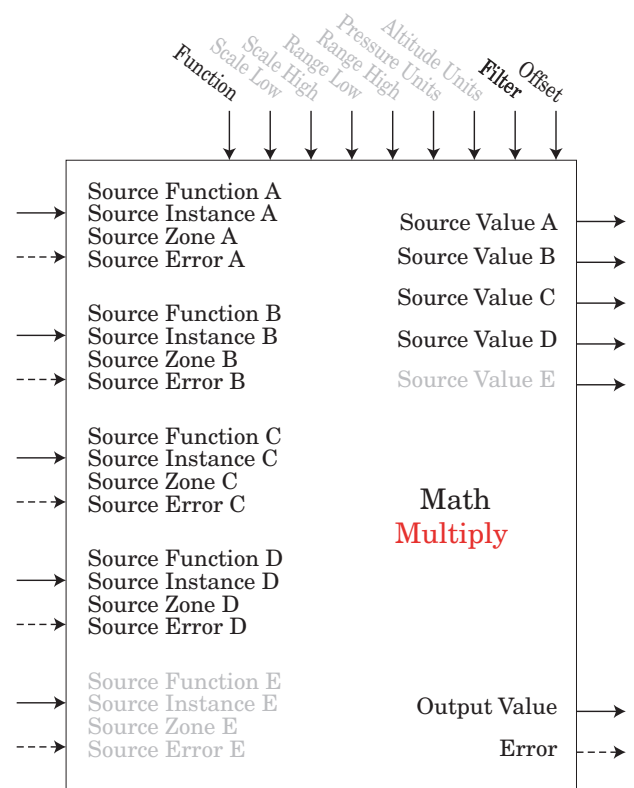

Output Value = Filter [(A * B * C * D) + Offset] Display units follows last temperature source else follow Source A

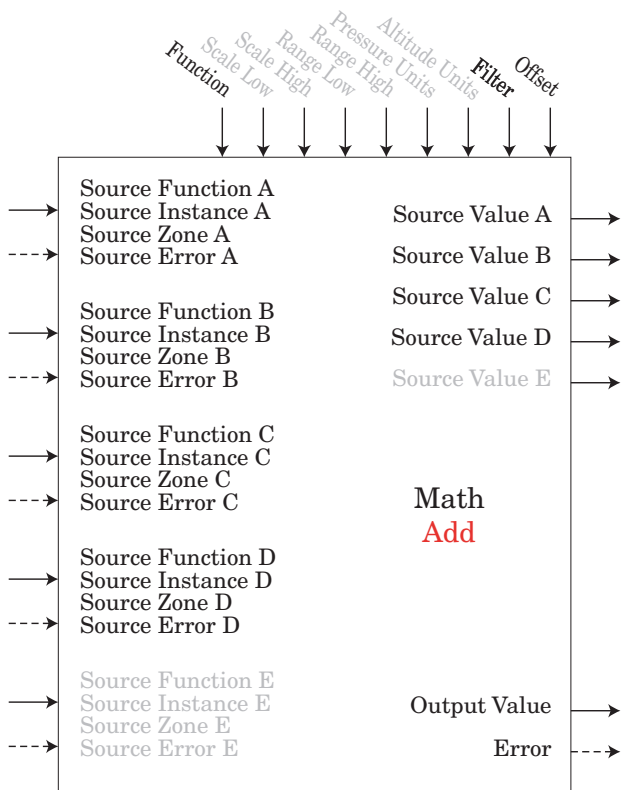

Output Value = Filter [(A + B + C + D) + Offset] Display units follows last temperature source else follow Source A

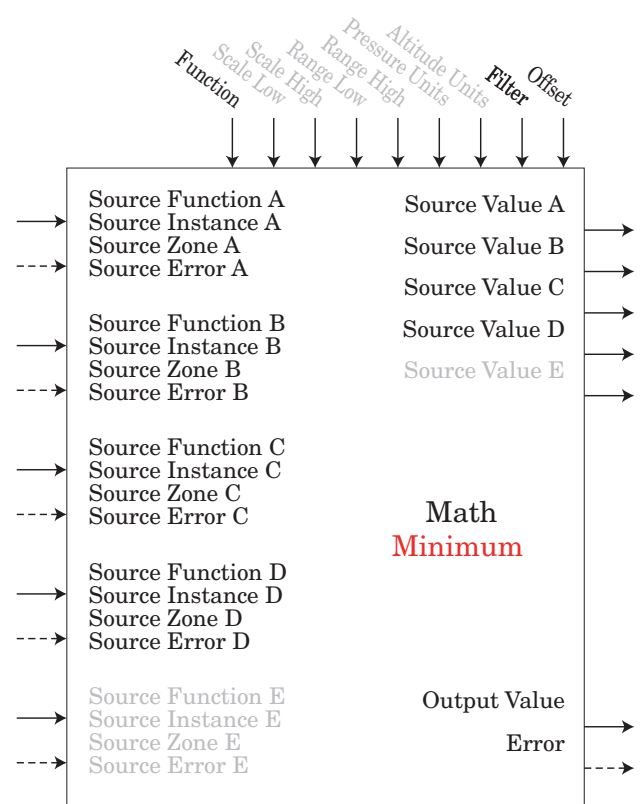

Output Value = Filter [Minimum Value (A : B : C : D) + Offset] Display units follows Source with minimum value.

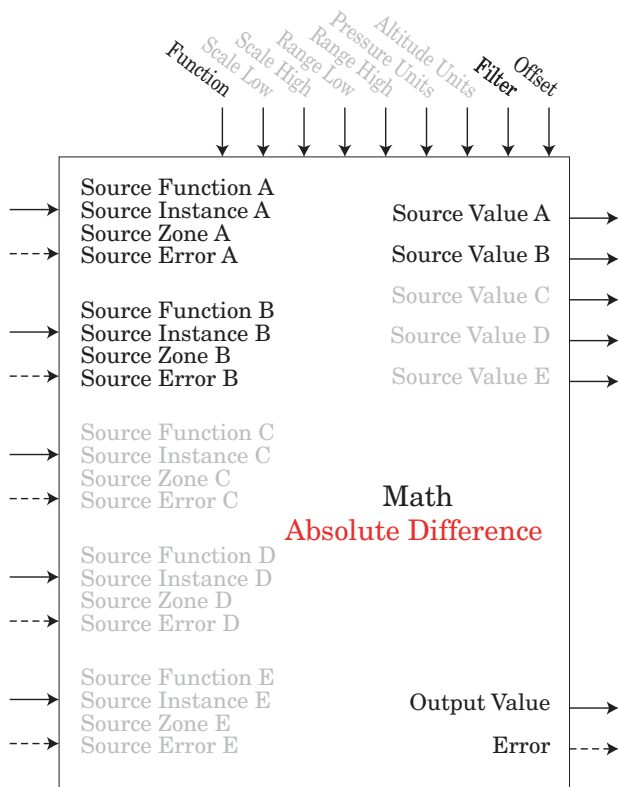

Output Value = Filter [| A - B | + Offset] Display units follow Source A plus relative Source B

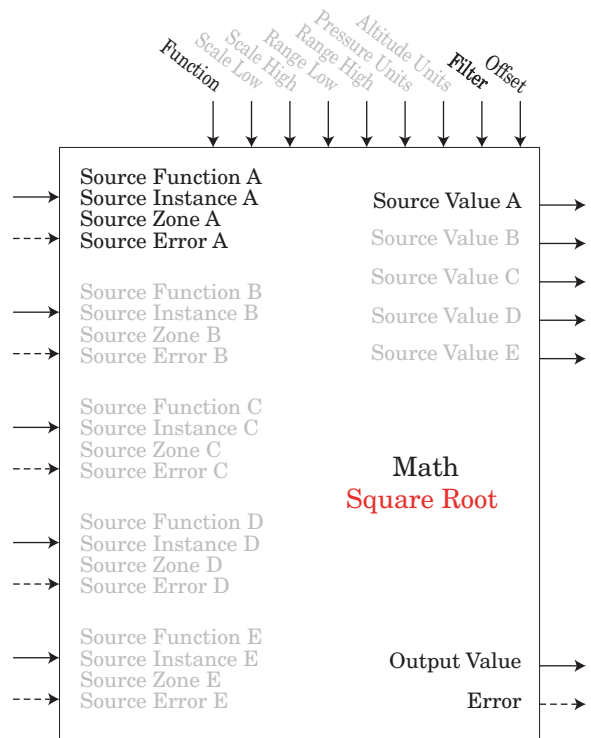

Output Value = Filter [Sqr Root A + Offset]
Display units follows Source A

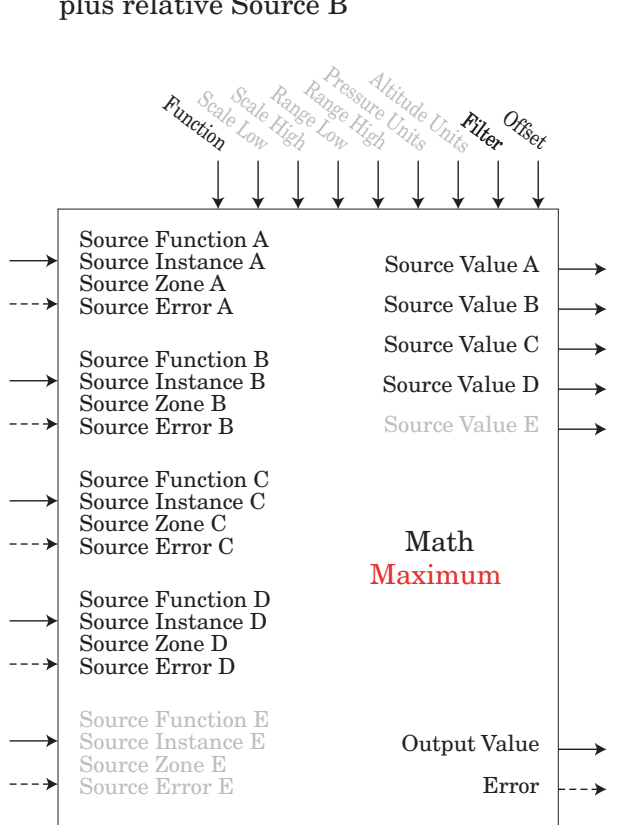

Output Value = Filter [Maximum Value (A : B : C : D) + Offset]
Display units follows Source with maximum value.

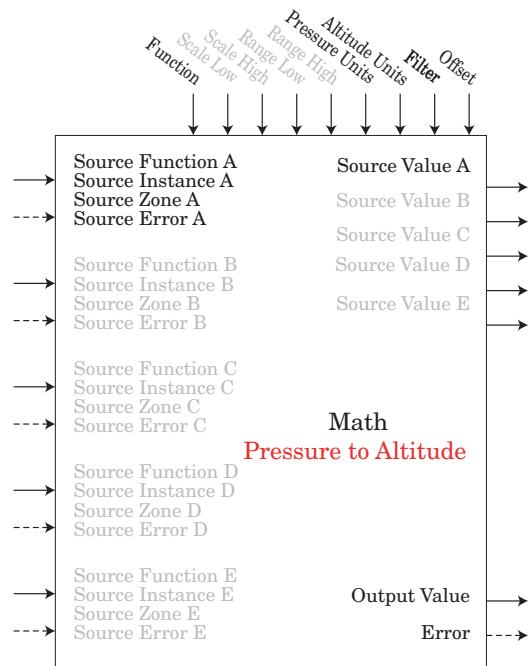

Output Value = Filter [Convert Source A in Pressure to Altitude + Offset]
Note: Pressure Altitude calculation is based on the International Standard Atmosphere 1976. Source A is a pressure signal and needs to be in PSI units for the calculation. The calculation is accurate from sea level to 90,000 feet. It can be used beyond this range in both directions, but with loss of accuracy. The standard is based on an altitude of 0 feet (sea level) pressure of 14.6967 PSI and a temperature of 59 degrees F. Result of calculation is in feet.

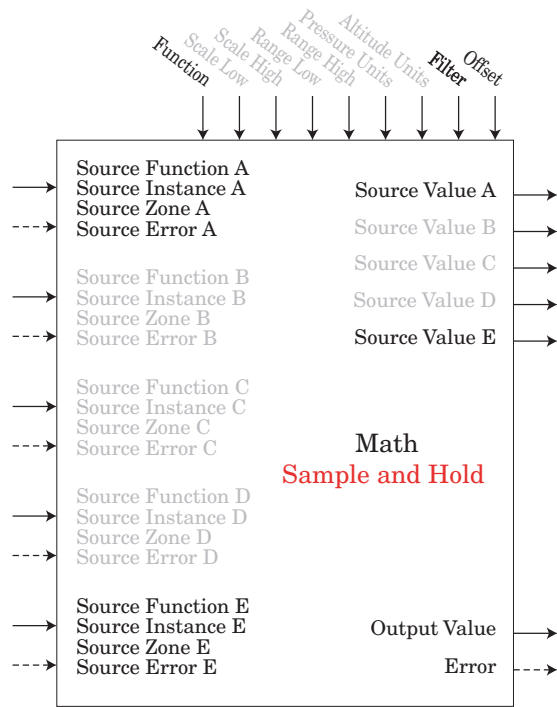

If E = OFF, Output Value = Filter [A + Offset]
 If E = ON, Output Value = Filter [last value of A + Offset]
 Display units follows Source A

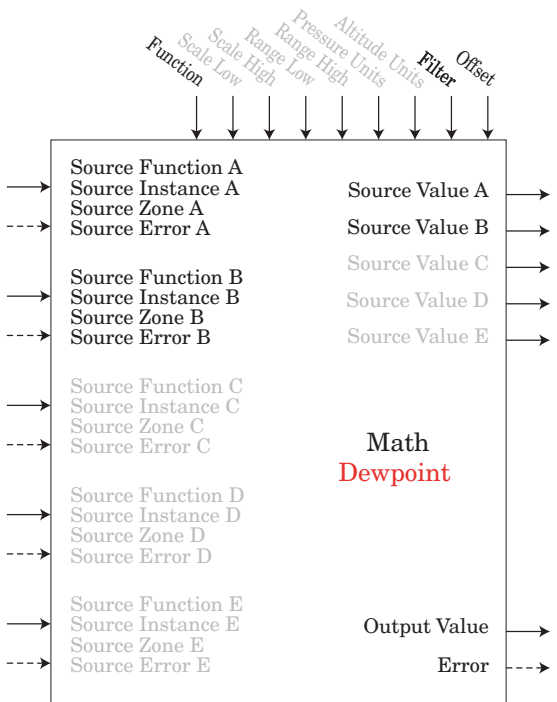

Output Value = Filter [427.26 * (CP * B / 8.8618) / (17.27 - (CP * B / 8.8618)) + 32 + Offset]
 Source A is used for Calculated Pressure or CP ;
 Note: For dewpoint, Source A is temperature (F) and Source B is RH (%). Saturation pressure calculation is identical to that used in wet/dry bulb. Result is in degrees F.

Output Function

This function configures and connects physical outputs to internal functions.

Note:

Digital Outputs not included on these sheets
 An error, when read, can indicate any of the following:
 None, Open, Shorted, Measurement Error, Bad Cal Data, Ambient Error, RTD Error, Fail, Math Error, Not Sourced, Stale

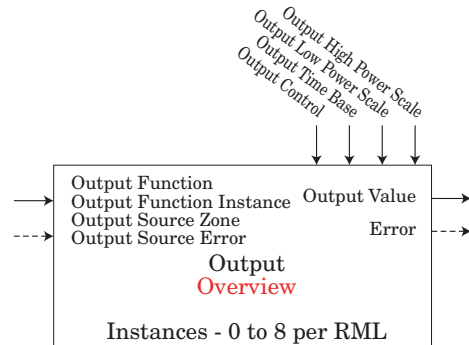

o t P E Output Menu
S E E Setup Page

- F n** Output Function : Off, Alarm, Compare, Counter, Digital I/O, Function Key, Linearization, Logic, Math, Timer, Variable, Limit
- F i** Output Function Instance : 1 to 250
- S Z** Output Source Zone : 0 to 16
- o C t** Output Control : Fixed Time Base
- o t b** Output Time Base : 0.1 to 60.0 seconds
- o L o** Output Low Power Scale : 0 to 100 %
- o h i** Output High Power Scale : 0 to 100 %

- o u** Output Value : On, Off
- o u** Output Value : 0 to 10.0 volts or 0 to 20.00 milliamperes

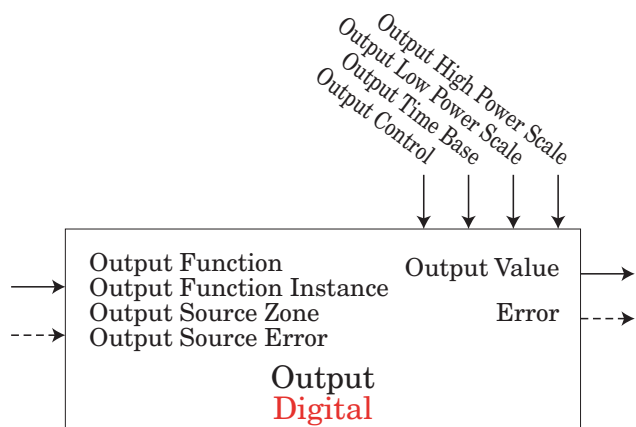
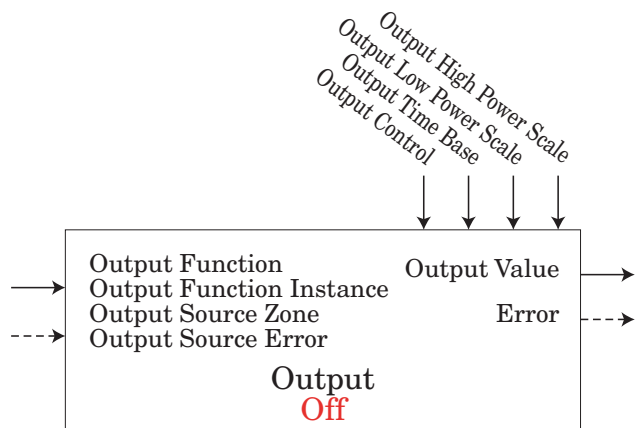

Security Function

Note:

Set on a Zone by Zone basis affecting any access using Standard Bus communications. Does not affect field protocols.. This is independent of the RUI Security Setting.

If the Password is enabled, the user must enter the Password to get to menus that have been blocked due to lock level settings. Rolling passwords require a new password each time the power has been cycled to the controller. It will be different for every controller. The administrator password is required to change the security settings even if the user enters their password to override the security settings.

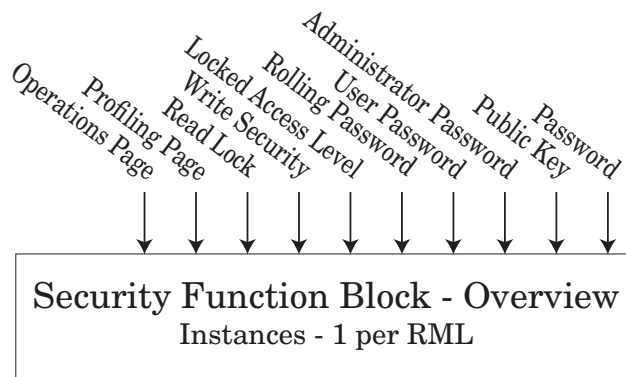

LoC Lock Menu
FRct Factory Page

- LoC.o** Operations Page : 1 to 3
- LoC.P** Profiling Page : 1 to 3
- PASe** Password Enable : Off, On
- r.LoC** Read Lock : 1 to 5
- S.LoC** Write Security: 1 to 5
- LoC.L** Locked Access Level : 1 to 5
- roLL** Rolling Password : Off, On
- PA5.u** User Password : 10 to 999
- PA5.A** Administrator Password : 10 to 999

ULoC Unlock Menu
FRct Factory Page

- CoDE** Public Key : xxx
- PA55** Password : xxx

Timer Function

An error, when read, can indicate any of the following:
 None, Open, Shorted, Measurement Error, Bad Cal Data,
 Ambient Error, RTD Error, Fail, Math Error, Not Sourced,
 Stale

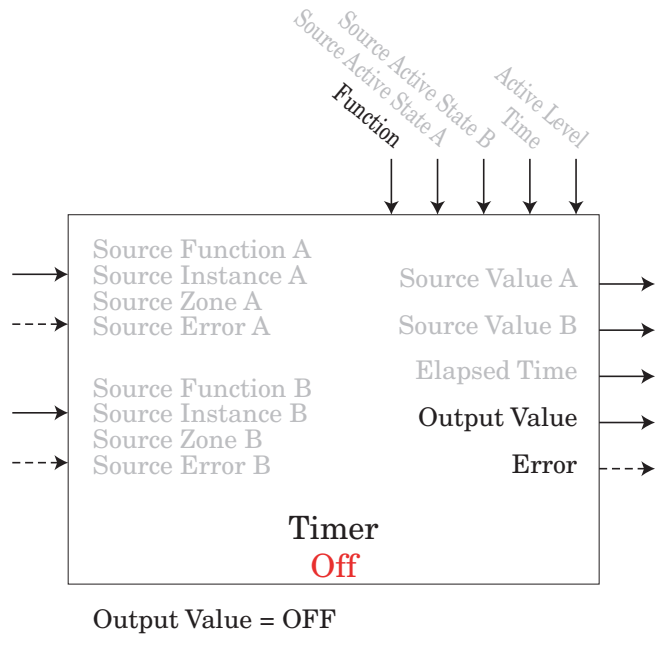
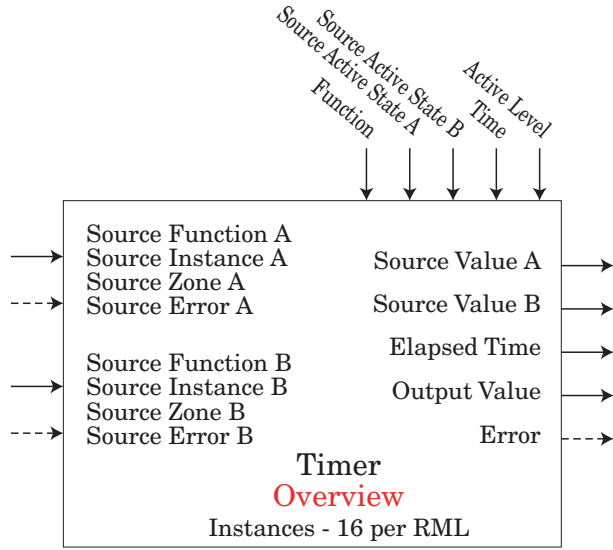

EP77 Timer Menu
5EE Setup Page

- F_n** Function : Off, On Pulse, Delay, One Shot, Retentive
- SFnA** Source Function A (Timer Run) : None, Alarm, Compare, Counter, Digital I/O, Profile Event Out A to H, Function Key, Logic, Special Function Output 1 to 4, Variable
- S_{iA}** Source Instance A : 1 to 250
- SzA** Source Zone A : 0 to 16
- SAS_A** Source Active State A (Timer Run) : High (rising), Low (falling)
- SFnB** Source Function B (Timer Reset) : None, Alarm, Compare, Counter, Digital I/O, Profile Event Out A to H, Function Key, Logic, Special Function Output 1 to 4, Timer, Variable
- S_{iB}** Source Instance B : 1 to 250
- SzB** Source Zone B : 0 to 16
- SAS_B** Source Active State B (Timer Reset) : High (rising), Low (falling)
- t** Time : 0 to 9,999 seconds
- LE_w** Active Level : High, Low

EP77 Timer Menu
OPER Operation Page

- S_{vA}** Source Value A : Off, On
- S_{vB}** Source Value B : Off, On
- EE** Elapsed Time : 0.0 to 9,999.000 seconds
- o_w** Output Value : Off, On

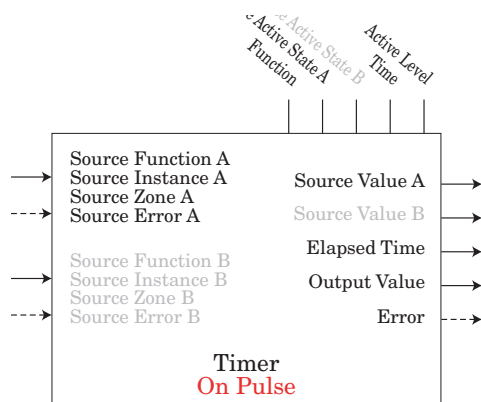

An On Pulse Timer is used to produce an output pulse of a constant duration. It can be used as a minimum on time for compressor control or other devices that do not want excessive cycling.

Timing Diagram of On Pulse with active state rising edge

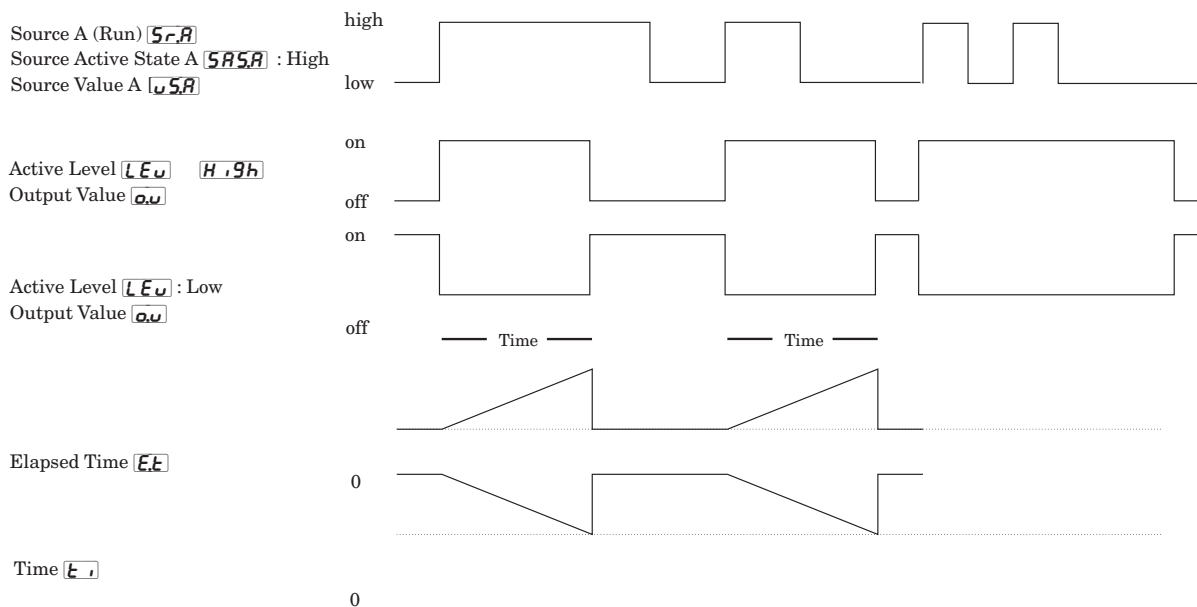

Timing Diagram of On Pulse with active state falling edge

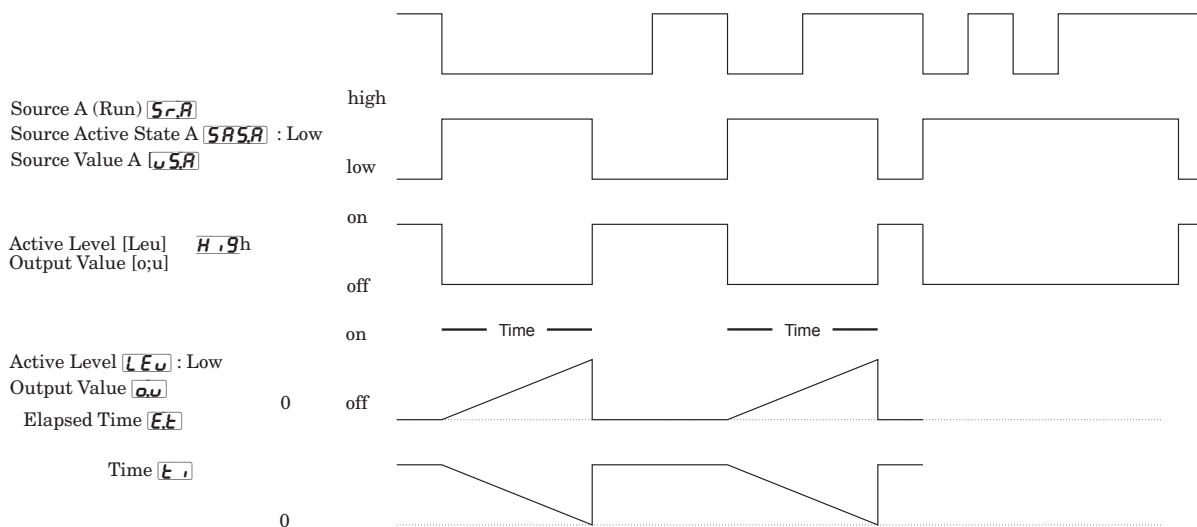

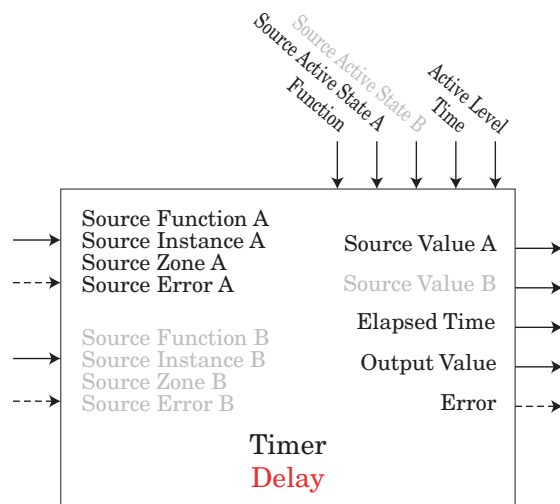

A delay timer is used to cause a delaying action. The delay can be made to happen on either the leading or trailing edge. This can be used to keep short input pulses from propagating or to have a secondary action occur at a known amount of time after the primary action; such as, turning on successive output devices.

Source A

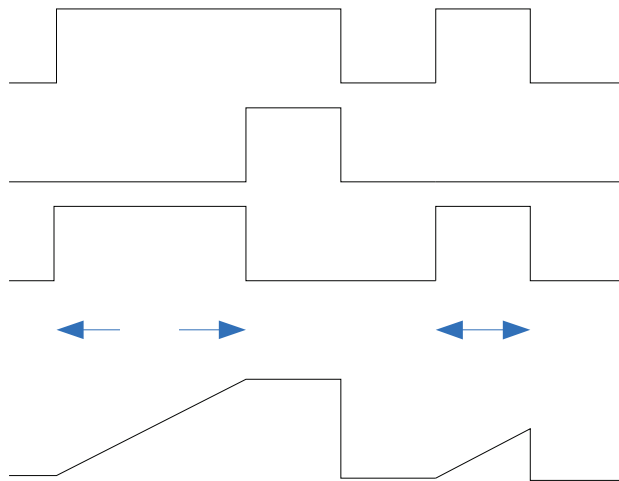

Source A

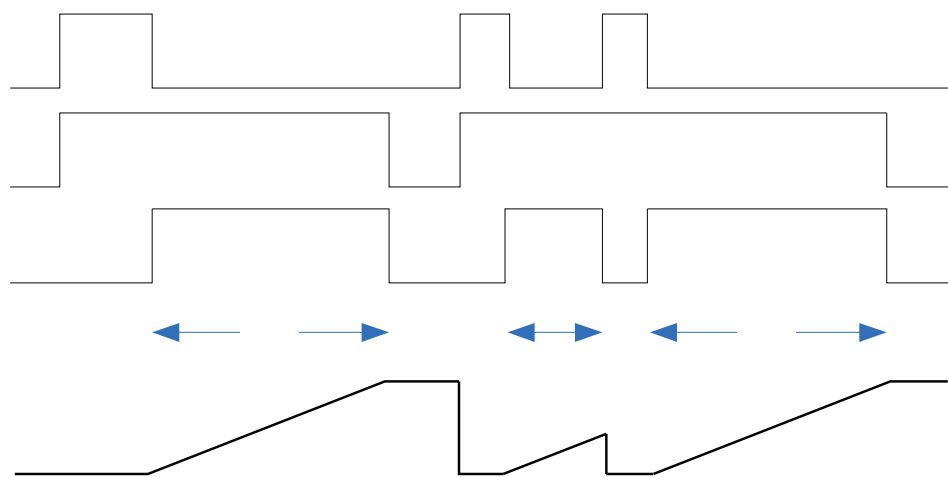

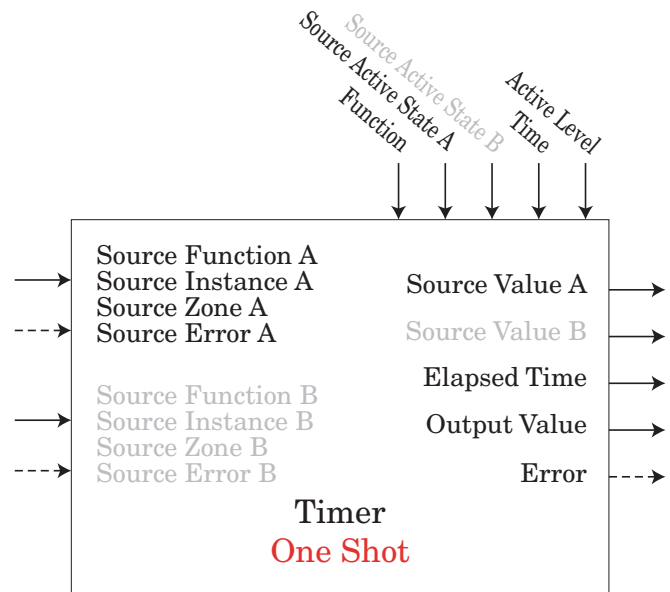

The One Shot timer functions like a simple oven timer. The time value gets set by the user and it counts down to zero without retaining the original time (hence the name one-shot). This is intended to be used in applications where the user will manually set different times for each process.

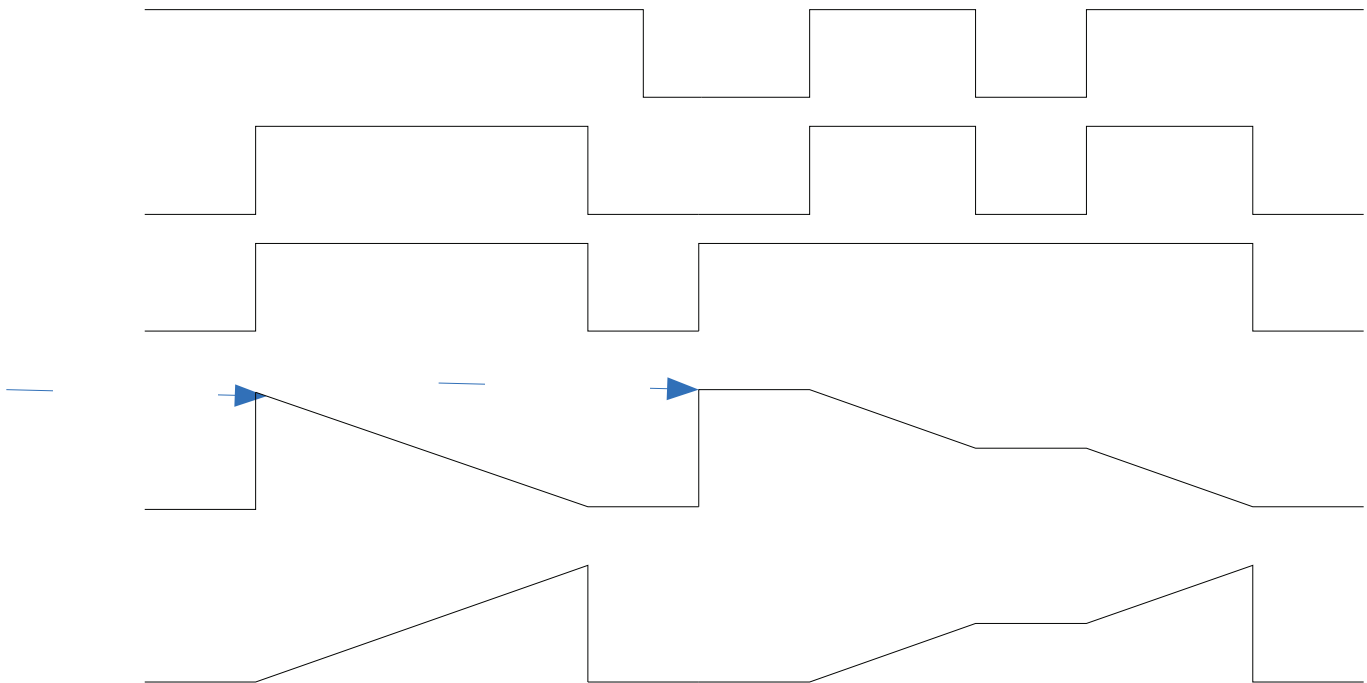

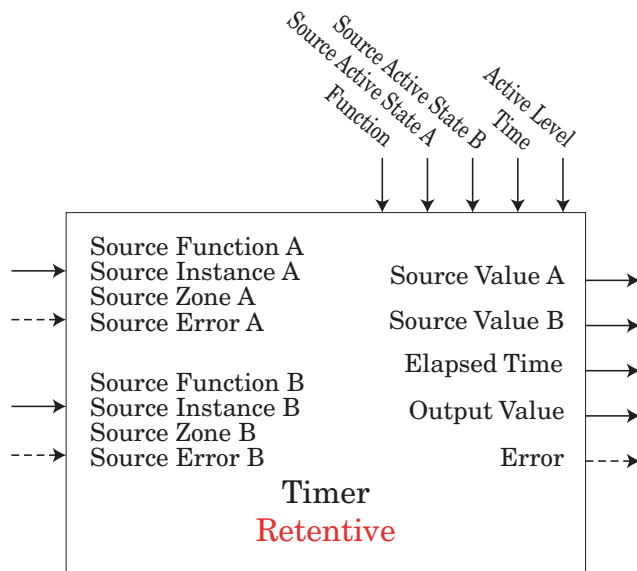

A retentive timer is used to keep track of how much time something has been in a particular state. This can be used to time how long something has been in an alarm state for example or how long it has been since a profile or step ran. The output can be used to trigger an event if the elapsed time has grown excessive.

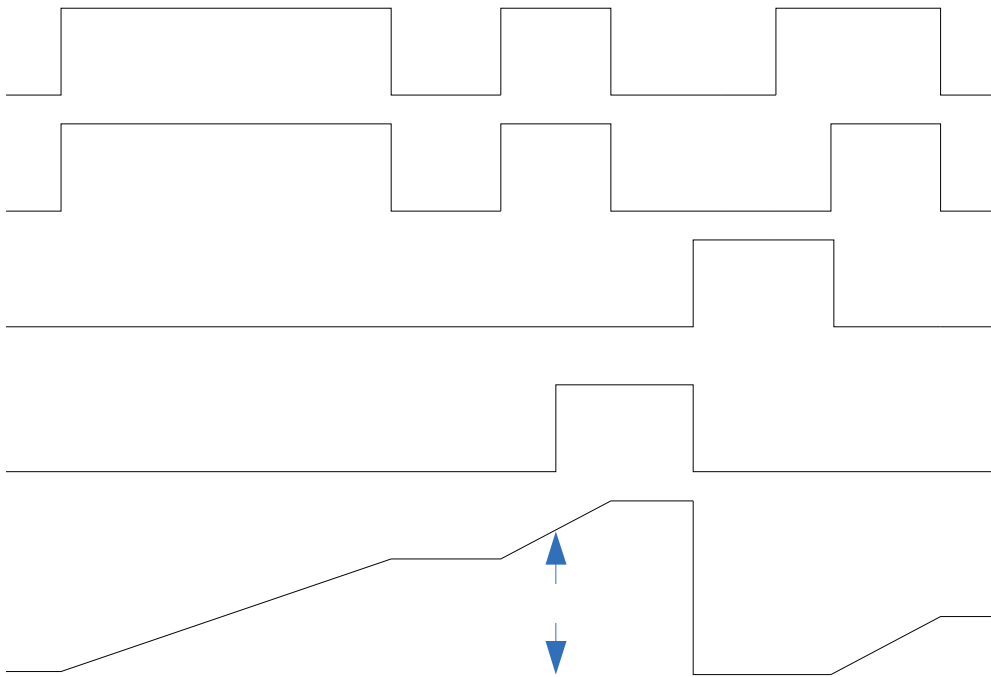

Variable Function

This function simply passes the stored value to its output.

An error, when read, can indicate any of the following: None, Open, Shorted, Measurement Error, Bad Cal Data, Ambient Error, RTD Error, Fail, Math Error, Not Sourced, Stale

A variable function block is used to store a user supplied value and provide a source input to another function block with that value. As an example, you could use a variable function value as one input to a compare function. The other input to the compare function would determine the output value based on the user's supplied value.

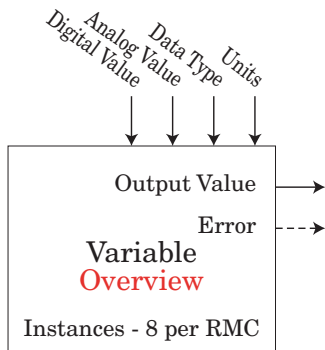
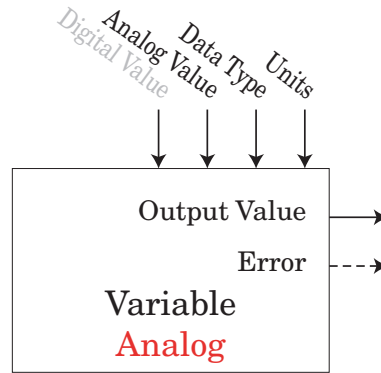
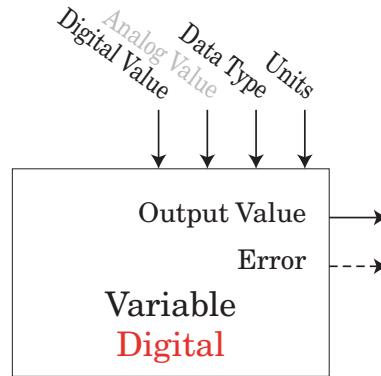

[JAR](#) Variable Menu
[SEE](#) Setup Page

TYPE	Data Type : Analog, Digital
d.g	Digital Value : On, Off
RnLg	Analog Value : -1,999.000 to 9,999.000
Unit	Units : None, Absolute Temperature, Relative Temperature, Power, Process Relative Humidity
ou	Output Value : -1,999.000 to 9,999.000 or On or Off

7

Chapter 7: Appendix

Modbus - Programmable Memory Blocks

The Modbus assembly contains 40 pointers to the parameters of your choosing starting at Modbus register 40 (shown on the following page). The pointers are 32-bits long so are stored in two sequential registers. As an example, if we want to move an alias to the analog input of the RML (register 410) into register 40, we perform a multiple write command (0x10 function) of 410 into register 40 and 411 into register 41 as a single multi-write command.

Once the parameters of choice have been defined and written to the pointer registers, the working registers 200 to 279 then represent those parameters. Therefore, as in the example above, if 410 is in register 40, 411 in register 41, register 200 & 201 contains the 32-bit floating point result for analog input 1.

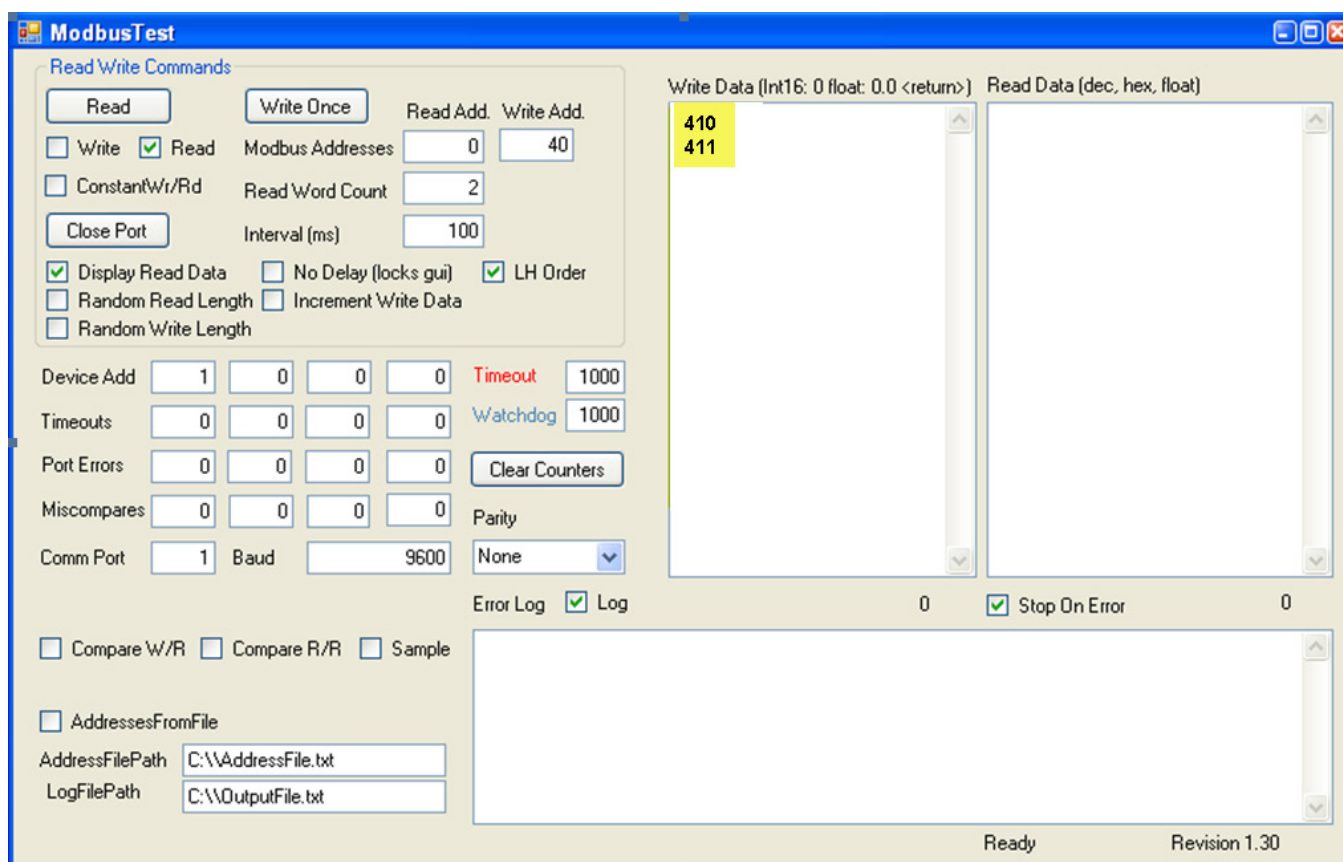

The screen shot above was taken from a program that can be found on the Watlow Support Tools DVD (shipped with the product) as well as on the Watlow website. On the DVD, it can be found under "Utility Tools" and is identified as "Modbus RTU Diagnostic Program for EZ-ZONE PM, RM and ST". A similar program can be found here as well for a connection utilizing Ethernet TCP.

If it is easier to go to the web to acquire this software click on the link below and type "modbus" in the search field where both versions can be found with the same name. <http://www.watlow.com/literature/software.cfm>

Assembly Pointer Registers and Assembly Working Registers

Pointer Addresses	Working Addresses		Pointer Addresses	Working Addresses
40 & 41	200 & 201		120 & 121	280 & 281
42 & 43	202 & 203		122 & 123	282 & 283
44 & 45	204 & 205		124 & 125	284 & 285
46 & 47	206 & 207		126 & 127	286 & 287
48 & 49	208 & 209		128 & 129	288 & 289
50 & 51	210 & 211		130 & 131	290 & 291
52 & 53	212 & 213		132 & 133	292 & 293
54 & 55	214 & 215		134 & 135	294 & 295
56 & 57	216 & 217		136 & 137	296 & 297
58 & 59	218 & 219		138 & 139	296 & 299
60 & 61	220 & 221		140 & 141	300 & 301
62 & 63	222 & 223		142 & 143	302 & 303
64 & 65	224 & 225		144 & 145	304 & 305
66 & 67	226 & 227		146 & 147	306 & 307
68 & 69	228 & 229		148 & 149	308 & 309
70 & 71	230 & 231		150 & 151	310 & 311
72 & 73	232 & 233		152 & 153	312 & 313
74 & 75	234 & 235		154 & 155	314 & 315
76 & 77	236 & 237		156 & 157	316 & 317
78 & 79	238 & 239		158 & 159	318 & 319
80 & 81	240 & 241		160 & 161	320 & 321
82 & 83	242 & 243		162 & 163	322 & 323
84 & 85	244 & 245		164 & 165	324 & 325
86 & 87	246 & 247		166 & 167	326 & 327
88 & 89	248 & 249		168 & 169	328 & 329
90 & 91	250 & 251		170 & 171	330 & 331
92 & 93	252 & 253		172 & 173	332 & 333
94 & 95	254 & 255		174 & 175	334 & 335
96 & 97	256 & 257		176 & 177	336 & 337
98 & 99	256 & 259		178 & 179	338 & 339
100 & 101	260 & 261		180 & 181	340 & 341
102 & 103	262 & 263		182 & 183	342 & 343
104 & 105	264 & 265		184 & 185	344 & 345
106 & 107	266 & 267		186 & 187	346 & 347
108 & 109	268 & 269		188 & 189	348 & 349
110 & 111	270 & 271		190 & 191	350 & 351
112 & 113	272 & 273		192 & 193	352 & 353
114 & 115	274 & 275		194 & 195	354 & 355
116 & 117	276 & 277		196 & 197	356 & 357
118 & 119	278 & 279		198 & 199	358 & 359

Modbus Default Assembly Structure 40-119

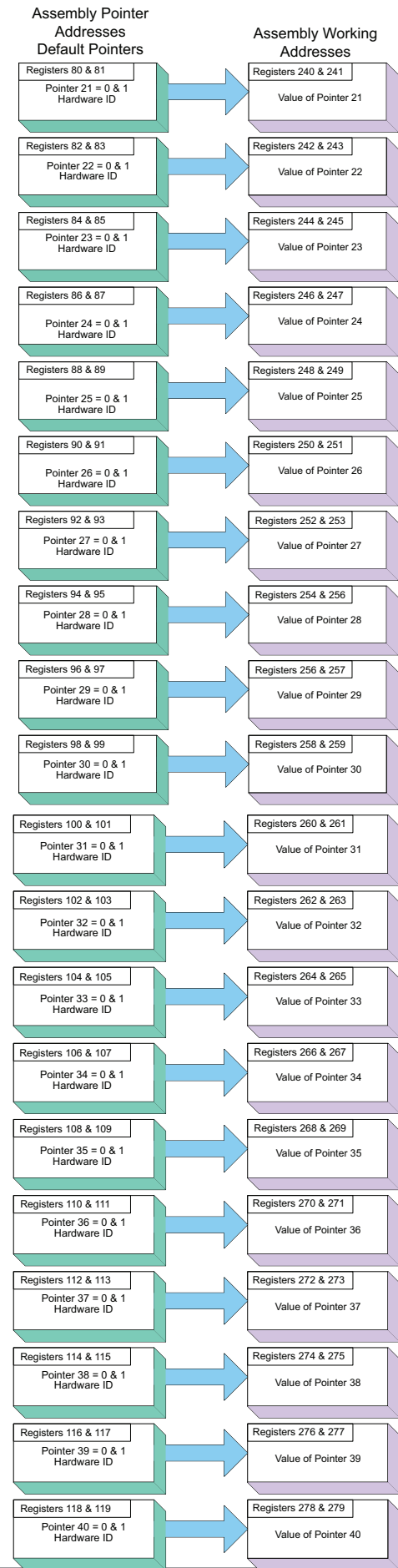
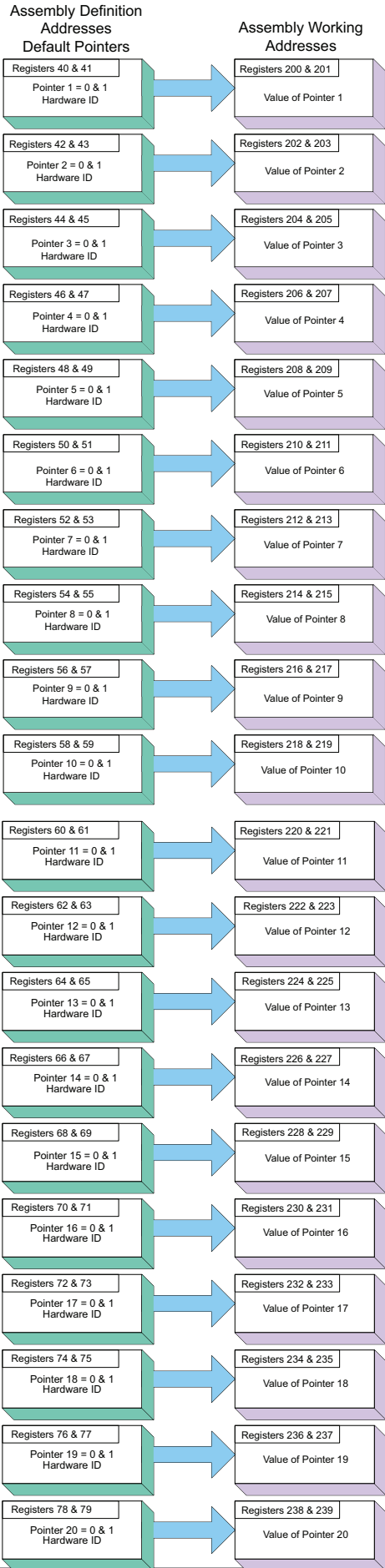

Modbus Default Assembly Structure 120-199

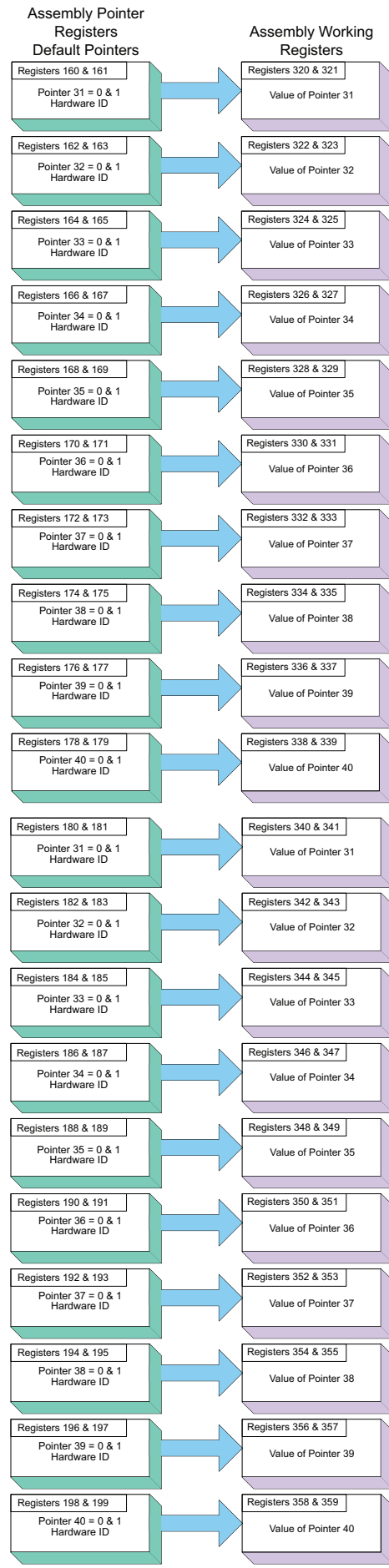
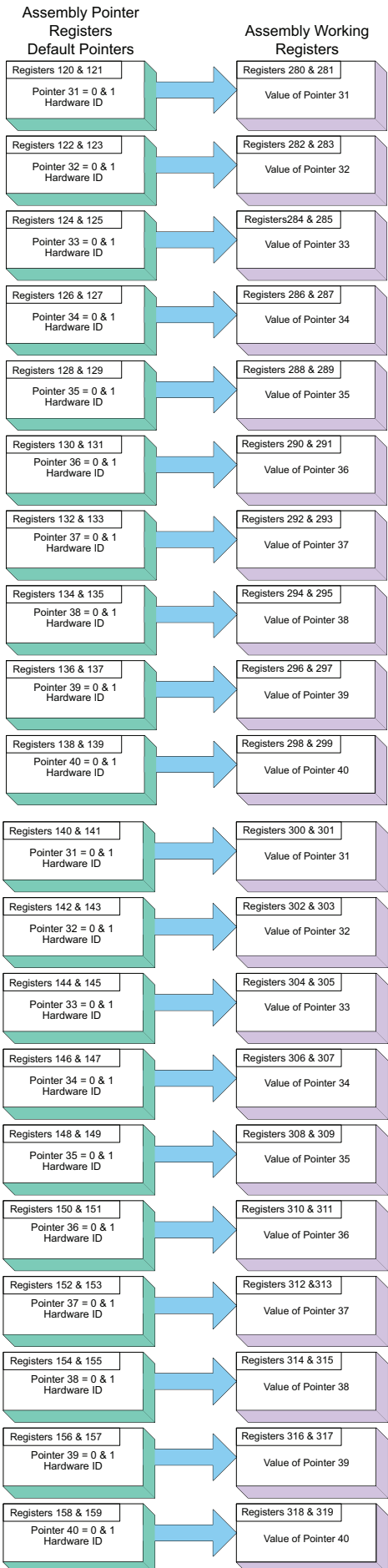

Troubleshooting Alarms, Errors and Module Issues

Indication	Description	Possible Cause(s)	Corrective Action
Alarm won't clear or reset	Alarm will not clear or reset with keypad or digital input	<ul style="list-style-type: none"> Alarm latching is active Alarm set to incorrect output Alarm is set to incorrect source Sensor input is out of alarm set point range Alarm set point is incorrect Alarm is set to incorrect type Digital input function is incorrect 	<ul style="list-style-type: none"> Reset alarm when process is within range or disable latching Set output to correct alarm source instance Set alarm source to correct input instance Correct cause of sensor input out of alarm range Set alarm set point to correct trip point Set alarm to correct type: process, deviation or power Set digital input function and source instance
Alarm won't occur	Alarm will not activate output	<ul style="list-style-type: none"> Alarm silencing is active Alarm blocking is active Alarm is set to incorrect output Alarm is set to incorrect source Alarm set point is incorrect Alarm is set to incorrect type 	<ul style="list-style-type: none"> Disable alarm silencing, if required Disable alarm blocking, if required Set output to correct alarm source instance Set alarm source to correct input instance Set alarm set point to correct trip point Set alarm to correct type: process, deviation or power
Alarm Error ALE1 ALE2 ALE3 ALE4 ALE5 ALE6 ALE7 ALE8 ALE9 AL10 AL11 AL12 AL13 AL14 AL15 AL16	Alarm state cannot be determined due to lack of sensor input	<ul style="list-style-type: none"> Sensor improperly wired or open Incorrect setting of sensor type Calibration corrupt 	<ul style="list-style-type: none"> Correct wiring or replace sensor Match setting to sensor used Check calibration of controller
Alarm Low ALL1 ALL2 ALL3 ALL4 ALL5 ALL6 ALL7 ALL8 ALL9 AL10 AL11 AL12 AL13 AL14 AL15 AL16	Sensor input below low alarm set point	<ul style="list-style-type: none"> Temperature is less than alarm set point Alarm is set to latching and an alarm occurred in the past Incorrect alarm set point Incorrect alarm source 	<ul style="list-style-type: none"> Check cause of under temperature Clear latched alarm Establish correct alarm set point Set alarm source to proper setting
Alarm High ALH1 ALH2 ALH3 ALH4 ALH5 ALH6 ALH7 ALH8 ALH9 AL10 AL11 AL12 AL13 AL14 AL15 AL16	Sensor input above high alarm set point	<ul style="list-style-type: none"> Temperature is greater than alarm set point Alarm is set to latching and an alarm occurred in the past Incorrect alarm set point Incorrect alarm source 	<ul style="list-style-type: none"> Check cause of over temperature Clear latched alarm Establish correct alarm set point Set alarm source to proper setting
No Display	No display indication or LED illumination	<ul style="list-style-type: none"> Power to controller is off Fuse open Breaker tripped Safety interlock switch open Separate system limit control activated Wiring error Incorrect voltage to controller 	<ul style="list-style-type: none"> Turn on power Replace fuse Reset breaker Close interlock switch Reset limit Correct wiring issue Apply correct voltage, check part number

Indication	Description	Possible Cause(s)	Corrective Action
No Serial Communication	Cannot establish serial communications with the controller	<ul style="list-style-type: none"> • Address parameter incorrect • Incorrect protocol selected • Baud rate incorrect • Parity incorrect • Wiring error • EIA-485 converter issue • Incorrect computer or PLC communications port • Incorrect software setup • Wires routed with power cables • Termination resistor may be required 	<ul style="list-style-type: none"> • Set unique addresses on network • Match protocol between devices • Match baud rate between devices • Match parity between devices • Correct wiring issue • Check settings or replace converter • Set correct communication port • Correct software setup to match controller • Route communications wires away from power wires • Place 120 Ω resistor across EIA-485 on last controller
Device Error [100] [rEEr]	Controller displays internal malfunction message at power up.	<ul style="list-style-type: none"> • Controller defective • Sensor input over driven 	<ul style="list-style-type: none"> • Replace or repair controller • Check sensors for ground loops, reverse wiring or out of range values.
Remote User Interface (RUI) menus inaccessible	Unable to access [SEt], [OPer], [FLtY] or [PrOF] menus or particular prompts in Home Page	<ul style="list-style-type: none"> • Security set to incorrect level 	<ul style="list-style-type: none"> • Check [LoC] settings in Factory Page • Enter appropriate password in [ULoC] setting in Factory Page
		<ul style="list-style-type: none"> • Digital input set to lockout keypad 	<ul style="list-style-type: none"> • Change state of digital input
		<ul style="list-style-type: none"> • Custom parameters incorrect 	<ul style="list-style-type: none"> • Change custom parameters in Factory Page
RUI value to low [uRLL]	Value to low to be displayed in 4 digit LED display <-1999	<ul style="list-style-type: none"> • Incorrect setup 	<ul style="list-style-type: none"> • Check scaling of source data

Detection of and Rules Around Abnormal Sensor Conditions	
Inputs	Detection of Abnormal Conditions
Thermocouple	
Shorted	No direct detection, Open loop firmware detection.
Open	Yes, Parasitic pull-up
Reversed	Yes, firmware detection
Current Source	
Shorted	Range limiting only
Open	Range limiting only
Reversed	Range limiting only
Voltage Source	
Open	Range limiting only
Shorted	Range limiting only
Reversed	Range limiting only
RTD	
S1 open	Yes, pulled up.
S2 open	Not implemented.
S3 open	Yes, pulled up.
S1 short to S2	Yes, pulled up
S1 short to S3	Yes, pulled down to under range.
S2 shorted to S3	Not implemented, Possible, monitor S2 voltage.
S1 and S2 open	Yes, pulled down to under range.
S1 and S3 open	Yes, S1 pulled up.
S2 and S3 open	Yes pulled up.
Thermistor	
S1 open	Yes, pulled up to sensor over range.
S3 open	Yes, pulled up to sensor over range.
S1 short to S3	Yes, pulled down to sensor under range.
S1 and S3 open	Yes, S1 pulled up to sensor over range.

RML Specifications

Line Voltage/Power

- 20.4 to 30.8V \approx (ac/dc), 50/60Hz, ± 5 percent
- Any external power supply used should comply with a class 2 or SELV rating. (See specific module specification listing for maximum VA power consumption)
- Data retention upon power failure via nonvolatile memory
- Compliant with Semi F47-0200, Figure R1-1 voltage sag requirements

Environment

- 0 to 149°F (-18 to 65°C) operating temperature
- -40 to 185°F (-40 to 85°C) storage temperature
- 0 to 90 percent RH, non-condensing
- Rail Mount modules are considered to be open type equipment needing to be installed in a fire and shock protection enclosure, such as a NEMA Type 1 enclosure; unless all circuit connections are Class 2 or SELV (Safety Extra Low Voltage)

Accuracy

- Calibration accuracy and sensor conformity: $\pm 0.1\%$ of span, $\pm 1^\circ\text{C}$ @ the calibrated ambient temperature and rated line voltage
- Types R, S, B; 0.2%
- Type T below -50°C ; 0.2%
- Calibration ambient temperature @ $77 \pm 5^\circ\text{F}$ ($25 \pm 3^\circ\text{C}$)
- Accuracy span :1000 °F (540°C) min.
- Temperature stability: ± 0.1 °F/°F ($\pm 0.1^\circ\text{C}/^\circ\text{C}$) rise in ambient max.

Agency Approvals

- UL® Listed to UL® 61010-1 File E185611
- UL® Reviewed to CSA C22.2 No.61010-1-04
- FM Class 3545 File 3039786 temperature limit switches
- CE-See Declaration of Conformity RoHS and W.E.E.E. compliant

Serial Communications

- All modules ship with isolated Standard Bus protocol for configuration and communication connection to all other EZ-ZONE products. As an optional feature Modbus RTU can also be ordered.

Optional User Interface (RUI)

- 1/16 DIN
- Dual 4 digit, 7-segment LED displays
- Seven-segment address LED, programmed via push-button switch
- Keys: Advance, infinity, up, down keys, plus an EZ-KEY programmable function key
- Typical display update rate 1Hz

Maximum Limit Configuration

- Up to 12 loops per module with a maximum of 16 modules

Mounting

- DIN-rail specification EN50022, 35 x 7.5 mm (1.38 x 0.30 in.)
- Can be DIN-rail mounted or chassis mounted with customer-supplied fasteners

Dimensions		Weight
155.0 mm (6.10 in)	116.08 mm (4.57 in)	Controller: 453.59 g (16 oz.)

Wiring Termination—Touch-Safe Terminals

- Right angle and front screw type terminal blocks (slots A, B, D, E)
 - Input, power and controller output terminals, touch-safe removable 12 to 30 AWG
- Wire strip length 7.6 mm (0.30 in.)
- Torque 0.8Nm (7.0 lb.-in.) right angle, 0.5Nm (4.51lb-in) front terminal block
- Use solid or stranded copper conductors only

Connector	Dimension "A" (mm/in.)
Standard	148 (5.80)
Straight	155 (6.10)

Optional Accessories

Power Supplies

- AC/DC Power supply converter 90-264V \sim (ac) to 24V \approx (dc) volts.
- P/N 0847-0299-0000: 31 W
- P/N 0847-0300-0000: 60 W
- P/N 0847-0301-0000: 91 W

EZ-ZONE RM Product Documentation

- User's Guide, printed hard copy, P/N 0600-0075-0000
- Watlow Support Tools CD, P/N 0601-0001-0000

Universal Input

- Thermocouple, grounded or ungrounded sensors
- $>20\text{M}\Omega$ input impedance
- 3 μA open sensor detection
- Max. of 2K Ω source resistance
- RTD 2 wire, platinum, 100 Ω and 1000 Ω @ 0°C calibration to DIN curve (0.00385 $\Omega/\Omega/^\circ\text{C}$)
- Process, 0-20mA @ 100 Ω ,or 0-10V \approx (dc) @ 20k Ω input impedance; scalable, 0-50mV, 0-1000 Ω

Voltage Input Ranges

- Accuracy $\pm 10\text{mV} \pm 1$ LSD at standard conditions
- Temperature stability ± 100 PPM/ $^\circ\text{C}$ maximum

Milliamp Input Ranges

- Accuracy $\pm 20\mu\text{A} \pm 1$ LSD at standard conditions
- Temperature stability ± 100 PPM/ $^\circ\text{C}$ maximum

Resolution Input Ranges

- 0 to 10V: 200 μV nominal
- 0 to 20 mA: 0.5 mA nominal

Input Type	Max Error @ 25 Deg C	Accuracy Range Low	Accuracy Range High	Units
J	± 1.75	0	750	Deg C
K	± 2.45	-200	1250	Deg C
T	± 1.55	-200	350	Deg C
N	± 2.25	0	1250	Deg C
E	± 2.10	-200	900	Deg C
R	± 3.9	0	1450	Deg C
S	± 3.9	0	1450	Deg C
B	± 2.66	870	1700	Deg C
C	± 3.32	0	2315	Deg C
D	± 3.32	0	2315	Deg C
F (PTII)	± 2.34	0	1343	Deg C
RTD, 100 ohm	± 2.00	-200	800	Deg C
RTD, 1000 ohm	± 2.00	-200	800	Deg C
mV	± 0.05	-50	50	mV
Volts	± 0.01	0	10	Volts
mA dc	± 0.02	0	20	mAmps DC
mA ac	± 5	-50	50	mAmps AC

Operating Range			
Input Type	Range Low	Range High	Units
J	-210	1200	Deg C
K	-270	1371	Deg C
T	-270	400	Deg C
N	-270	1300	Deg C
E	-270	1000	Deg C
R	-50	1767	Deg C
S	-50	1767	Deg C
B	-50	1816	Deg C
C	0	2315	Deg C
D	0	2315	Deg C
F (PTII)	0	1343	Deg C
RTD (100 ohm)	-200	800	Deg C
RTD (1000 ohm)	-200	800	Deg C
mV	0	50	mV
Volts	0	10	Volts
mAdc	0	20	mAmps DC
mAac	0	50	mAmps AC
Resistance, 5K range	0	5000	Ohms
Resistance, 10K range	0	10000	Ohms
Resistance, 20K range	0	20000	Ohms
Resistance, 40K range	0	40000	Ohms
Resistance, 40K range	0	40000	Ohms

Thermistor Input				
Input Type	Max Error @ 25 Deg C	Accuracy Range Low	Accuracy Range High	Units
Thermistor, 5K range	±5	0	5000	Ohms
Thermistor, 10K range	±10	0	10000	Ohms
Thermistor, 20K range	±20	0	20000	Ohms
Thermistor, 40K range	±40	0	40000	Ohms

- 0 to 40KΩ, 0 to 20KΩ, 0 to 10KΩ, 0 to 5KΩ
- 2.252KΩ and 10KΩ base at 25°C
- Linearization curves built in
- Third party Thermistor compatibility requirements

Base R @ 25C	Alpha Techniques	Beta THERM	YSI	Thermistor Curve
2.252K	Curve A	2.2K3A	004	A
10K	Curve A	10K3A	016	B
10K	Curve C	10K4A	006	C

Digital Input

- Update rate 10Hz
- DC voltage
 - Max. input 36V at 3mA
 - Min. high state 3V at 0.25mA
 - Max. low state 2V

Dry Contact

- Update rate 10Hz
- Min. open resistance 10KΩ
- Max. closed resistance 50Ω

Output Hardware

- Electromechanical relay, Form A, 24 to 240VAC or 30VDC max., 5A resistive load, 100,000 cycles at rated load, 120/240 @ 125 VA or 24VAC @ 25VA pilot duty
- Electromechanical relay, Form C, 24 to 240VAC or 30VDC max., 5A resistive load, 100,000 cycles at rated load, 120/240 @ 125 VA or 24VAC @ 25VA pilot duty
- Digital outputs
 - Update rate 10Hz
 - Switched DC
 - Output voltage 20V[≠] (dc)
 - Max. supply current source 40mA at 20V[≠] (dc) and 80mA at 12V[≠] (dc)
 - Open Collector
 - Switched voltage max.: 32V[≠] (dc)
 - Max. switched current per output: 1.5A
 - Max. switched current for all 6 outputs combined: 8A
- 0 to 10V[≠] (dc) into a min. 1,000Ω load
- 0 to 20mA into max. 800Ω load

Programmable Application Blocks

Actions (events) 16 total

Alarms 16 total

Limit Loops 12 total

Compare 16 total

Off, greater than, less than, equal, not equal, greater than or equal, less than or equal

Counters 16 total

Counts up or down loads, predetermined value on load signal.
Output is active when count value equals predetermined target value

Logic 16 total

Off, and, nand, or, nor, equal, not equal, Latch

Linearization 16 total

Interpolated or stepped relationship

Math 16 total

Off, average, process scale, deviation scale, differential (subtraction), ratio (divide), add, multiply, absolute difference, min., max., square root, sample and hold

Timers 16 total

On Pulse produces output of fixed time on active edge of timer run signal

Delay output is a delayed start of timer run, off at same time

One Shot oven timer

Retentive measures timer run signal, output on when accumulated time exceeds target

Variable 16 total

User value for digital or analog variable

Note:

These specifications are subject to change without prior notice.

EZ-ZONE Rail-Mount Limit Module Ordering Information

Limit module requires a Class 2 or SELV power supply 20.4 to 30.8 V ~(ac) / —(dc), communication port provided for configuration with EZ-ZONE Configurator software.

Code Number

①② EZ-ZONE Rail Mount	③ Limit Module	④ Connector Style/ Custom Product	⑤ Slot A	⑥ Slot B	⑦ Slot D	⑧ Slot E	⑨ Future Options	⑩ Enhanced Options	⑪⑫ Additional Options
RM	L	-					A		AA

Connector Style/Custom Product - Digit ④

- A = Right angle screw connector (standard)
- F = Front screw connector
- S = Custom

Slot A - Digit ⑤

- 5 = 4 Universal inputs (t/c, 2-wire RTD, 0-10Vdc, 0-20mA) with 4 limit control loops
- 6 = 4 Thermistor inputs with 4 limit control loops

Slot B - Digit ⑥

- A = None
- 5 = 4 Universal inputs (t/c, 2-wire RTD, 0-10Vdc, 0-20mA) with 4 limit control loops
- 6 = 4 Thermistor inputs with 4 limit control loops

Slot D - Digit ⑦

- A = None
- 5 = 4 Universal inputs (t/c, 2-wire RTD, 0-10Vdc, 0-20mA) with 4 limit control loops
- 6 = 4 Thermistor inputs with 4 limit control loops
- J = 4 Mechanical relay 5A, Form A
- C = 6 Digital I/O

Slot E - Digit ⑧

- J = 4 Mechanical relay 5A, Form A
- B = 1 Digital input and 1 Form C, 1 Form A Mechanical relays

Future Options - Digit ⑨

- A = Standard

Enhanced Options - Digit ⑩

- A = Standard Bus
- 1 = Standard Bus and Modbus RTU 485 (selectable via switch)

Additional Options - Digits ⑪ ⑫

Firmware, Overlays, Parameter Settings

- AA = Standard
- AB = Replacement connectors hardware only, for the entered model number
- XX = Custom (consult factory)

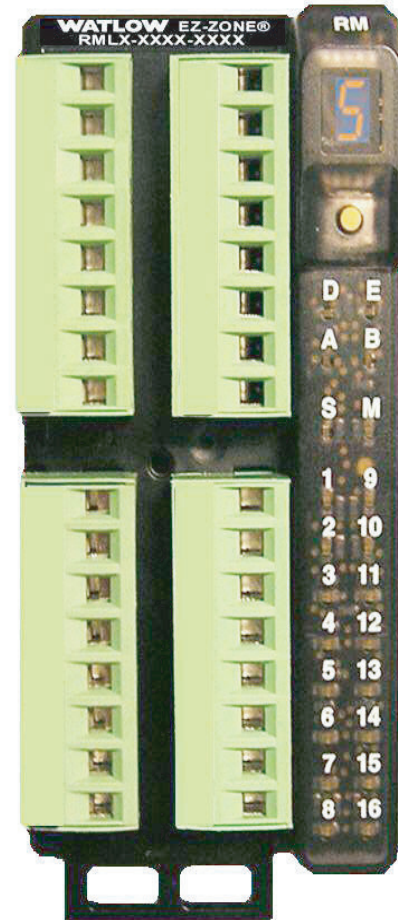

Watlow®, EZ-ZONE® and TRU-TUNE® are registered trademarks of Watlow Electric Manufacturing Company.

UL® is a registered trademark of Underwriter's Laboratories, Inc.

Modbus® is a registered trademark of Schneider Automation Incorporated.

DeviceNet™ and EtherNet/IP™ are trademarks of Open DeviceNet Vendors Association.

Index

RbL Alarm Blocking 50, 82
ACLF AC Line Frequency 71
ACLR Alarm Clear Request 50
ACE Action Menu 33, 46
RdSP Alarm Display 50
Rh Alarm High Set Point 34, 50, 51, 81
RHy Alarm Hysteresis 49, 81
A Analog Input Menu 32, 43
RS Alarm Source Instance 49
RLA Alarm Latching 50, 82
RLG Alarm Logic 49
RLP Alarm Menu 34, 49
RLo Alarm Low Set Point 34, 50, 81
RSd Alarm Sides 50
RS Alarm Silencing 50, 82
RSr Alarm Silence Request 51
RSE Alarm State 51
REtn Attention 82
REY Alarm Type 49
Runt Altitude Units 42, 70
BRUD Baud Rate 71
C.F Display Units 71
Code Public Key 75
CoP Communications Menu 71
CPE Compare Menu 36, 53
Ctr Counter Menu 37, 57
CUSE Custom Setup 74
dMEE Date of Manufacture 76
dEC Decimal 44
dELU Dewpoint 67
d,AG Diagnostics Menu 76
d,io Digital Input/Output Menu 32, 45
d,r Direction 45
doS Digital Output State 32
dPrS Display Pairs 42, 71
E,S Event Input Status 32
EL,io Electrical Input Offset 76, 79
EL,S Electrical Input Slope 77, 80
F Digital Output Function Instance 45
F Output Function Instance 48
F,L Filter 44
Fn Output Function 48
GLbL Global Menu 71
,CR Calibration Offset 32, 44, 79–80
,Er Input Error Latching 44
,Er Input Error Status 32, 44
,PF4 IP Fixed Address Part 4 71
L9C Logic Menu 38, 59
LhY Limit Hysteresis 47
L,P Limit Menu 33, 47
L,n Linearization 43

LLS Limit Low Set Point 33, 47
Lnc Linearization Menu 35, 51
LoC Security Setting Menu 74, 75
LoCL Locked Access Level 75
LoCo Lock Operations Page 74, 82
LoCP Lock Profiling Page 74, 75, 82
LSd Limit Sides 47
PTRE Math Menu 39, 67
PTHL Modbus Word Order 72
PTu Electrical Measurement 76, 79, 80
nUS Non-volatile Save 72
oCt Output Control 45, 48
oh Output High Power Scale 46, 49
oLo Output Low Power Scale 45, 49
oCb Output Time Base 45, 48
oEPt Output Menu 48
PAR Parity 71
PASr Administrator Password 75
PASe Password Enable 74
PASS Password 75
PASu User Password 75
PEE Process Error Enable 43
PEL Process Error Low 44
Pn Part Number 76
P,unt Pressure Units 42
rEu Software Revision 76
rh Range High 43, 81
rLo Range Low 43, 81
rLoC Read Lockout Security 74, 82
roLL Rolling Password 75
rEL RTD Leads 43
SEn Sensor Type 43, 80
SFnA Source Function A 49
Sh Scale High 43, 81
SLoC Set Lockout Security 75, 82, 83
SLo Scale Low 43, 81
Sn Serial Number 76
SbLd Software Build 76
EPTr Timer Menu 36, 55
ULoC Unlock 73
USr,r User Restore Set 71, 79
USr,S User Save Set 71, 79
uAr Variable Menu 70

A

AC Line Frequency 71
 Action Menu 33, 46
 Address Standard Bus 72
 Administrator Password 75
 agency approvals 4

alarm blocking 82
 Alarm Clear Request 50
 Alarm Menu 34, 49
 alarms
 Blocking 50, 82
 Display 50
 Hysteresis 49, 81
 Latching 50, 81
 Logic 49
 process 81
 set points 81
 Sides 50
 Silencing 50, 82
 Source 49
 Type 49
 Alarm Silence Request 51
 Alarm State 51
 Altitude Units 42, 70
 Analog Input Function 88
 Analog Input Menu 32, 43
 Assembly Definition Addresses 84
 Assembly Working Addresses 84

B

Baud Rate 71
 Blocking 50, 82

C

calibrating an analog input 79
 Calibration Offset 32, 44, 79–80
 CIP (Common Industrial Protocol) 29
 Clear Request 50
 Communications Menu 71
 Setup Page 31, 41
 Compare Function 90
 Compare Menu 36, 53
 connecting and wiring the modules 28
 Control 45, 48
 Control Module Menus
 Factory Page
 Custom Setup Menu 74
 Diagnostics Menu 76
 Security Setting Menu 74, 75
 Operations Page
 Action Menu 33
 Alarm Menu 34
 Analog Input Menu 32
 Compare Menu 36
 Counter Menu 37
 Digital Input/Output Menu 32
 Limit Menu 33
 Linearization Menu 35
 Logic Menu 38
 Math Menu 39
 Timer Menu 36
 Setup Page

- Action Menu 46
- Alarm Menu 49
- Analog Input Menu 43
- Communications Menu 71
- Compare Menu 53
- Counter Menu 57
- Digital Input/Output Menu 45
- Global Menu 71
- Limit Menu 47
- Linearization Menu 51
- Logic Menu 59
- Math Menu 67
- Output Menu 48
- Timer Menu 55
- Variable Menu 70
- Counter Menu 37, 57
- current measurement 117
- current sensing 82
- Current Sensing 82
- Custom Function 92
- Custom Setup Menu 74
- D**
- Date of Manufacture 76
- Decimal 44
- Dewpoint 67
- Diagnostics Menu 76
- Digital Input Function 5
- Digital Input/Output Menu 32, 45
- digital inputs 5
- digital input specifications 117
- Direction 45
- Display 50
- Display Pairs 42, 71
- Display Units 71
- E**
- Electrical Gain 80
- Electrical Input Offset 76
- Electrical Input Slope 77
- Electrical Measurement 76, 79, 80
- Electrical Offset 79, 80
- Electrical Slope 80
- environment 117
- F**
- Factory Page
 - Control Module 73
- Filter Time 44, 80
- filter time constant 80
- Function Instance 45
- G**
- Global Function 93
- Global Menu 71
 - Setup Page 31, 41
- H**
- High Power Scale 46, 49
- high range 81
- high scale 80
- High Set Point
 - Alarm 34, 35, 50, 51, 81
 - Loop 80
- Hysteresis 47, 49, 81
- I**
- Input Error Latching 44
- Input Error Status 32, 44
- input events 5
- inputs 5
- installation 14
- IP Fixed Address Part 4 71
- isolation blocks 19
- J**
- K**
- L**
- Latching 50, 82
- Limit Menu 33, 47
- Linearization 43
- Linearization Menu 35, 51
- line voltage/power 117
- Locked Access Level 75
- Lock Operations Page 82
- Lockout Menu 82
- Lock Profiling Page 82
- Logic 49
- Logic Function 95
- Logic Menu 38, 59
- Low Power Scale 45, 49
- low range 81
- low scale 80
- Low Set Point
 - Alarm 34, 50, 81
 - Limit 33, 47
 - Loop 80
- M**
- Math Menu 39, 67
- Modbus Default Assembly Structure
 - 80-119 113, 114
- Modbus - Using Programmable
 - Memory Blocks 84
- Modbus Word Order 72
- Module Limit 5
- N**
- navigating
 - Factory Page 73
 - Setup Page 31, 41
- network wiring 27
- Non-volatile Save 42, 72
- O**
- Operations Page
 - Control Module 31
- operator interface 117
- ordering information
 - integrated controller models 119
- Output Menu 48
- outputs 5
- Output State 32, 33
- P**
- P3T armor sealing system 4
- Parameter 1 to 20 74
- Parameter ID 29
- Parity 71
- Part Number 76
- Password 73, 75
- Peltier Delay 42
- power supplies 13
- Pressure Units 42
- process alarms 81
- Process Error Enable 43
- Process Error Low 44
- Process Value 32, 44
- Profibus 30
- Profibus Index 29
- programming the Home Page 79
- Public Key 73, 75
- Q**
- R**
- Range High 43, 81
- Range Low 43, 81
- Read Lockout Security 82
- receiving a remote set point 81
- restoring user settings 79
- Rolling Password 75
- S**
- saving user settings 79
- Scale High 43, 81
- Scale Low 43, 81
- secure settings 82, 83
- Security Setting 74, 75
- sensor backup 80
- sensor selection 80
- Sensor Type 43, 80
- serial communications 117
- Serial Number 76
- Set Lockout Security 82
- set point high limit 80
- set point low limit 80
- Setup Page
 - Control Module 41
- Sides
 - Alarm 50
 - Limit 47
- Silence Request 51
- Silencing 50, 82
- Software Build 76
- Software Configuration 85
- Software Revision 76

Source 49
Specifications 117
standard connector, all modules 18
State 51
System Security 83

T

Ten Point Linearization 81
Time Base 45, 48
Timer Function 105
Timer Menu 36, 55
tuning the PID parameters 79
Type 49

U

User Password 75
User Restore Set 71, 79
User Save Set 71, 79
Using EZ-ZONE® Configurator Software 85
using the software 82

V

Variable Function 110
Variable Menu 70

W

wiring
 Modbus RTU or standard bus EIA-485 communications 25
 output 1 mechanical relay, form C 24
wiring a network 27, 28
wiring a serial EIA-485 network 27
wiring, Controller Module communications 20
 digital inputs/outputs 7 through 12 21, 22
 low power 20
 mechanical relay, form A output 2, 4, 6 or 8 24
 RTD input 1 to 4 21
 thermistor input 1 to 4 21
 thermocouple input 1 to 4 20
wiring termination, touch-safe terminals 117

X

Y

Z

Declaration of Conformity

EZ Zone Series RM



WATLOW
1241 Bundy Blvd.
Winona, MN 55987 USA

an ISO 9001 approved facility since 1996.

Declares that the following Series RM (Rail Mount) products:

Model Numbers: **RM** followed by additional letters or numbers describing use of up to four module options of various inputs and outputs or communications.
Classification: Temperature control, Installation Category II, Pollution degree 2
Voltage and Frequency: SELV 24 to 28 V \approx ac 50/60 Hz or dc
Power Consumption: RMA models 4 Watts, any other RM model 7 Watts
Environmental Rating: IP20

Meet the essential requirements of the following European Union Directives by using the relevant standards show below to indicate compliance.

2004/108/EC Electromagnetic Compatibility Directive

EN 61326-1	2006	Electrical equipment for measurement, control and laboratory use – EMC requirements, Industrial Immunity, Class A Emissions (<i>Not for use in a Class B environment without additional filtering</i>).
EN 61000-4-2	2008	Electrostatic Discharge Immunity
EN 61000-4-3	2010	Radiated Field Immunity
EN 61000-4-4	2011	Electrical Fast-Transient / Burst Immunity
EN 61000-4-5	2006	Surge Immunity
EN 61000-4-6	2008	Conducted Immunity
EN 61000-4-11	2004	Voltage Dips, Short Interruptions and Voltage Variations Immunity
EN 61000-3-2	2005	Harmonic Current Emissions
EN 61000-3-3 ¹	2005	Voltage Fluctuations and Flicker
SEMI F47	2000	Specification for Semiconductor Sag Immunity Figure R1-1

¹**NOTE: To comply with flicker requirements cycle time may need to be up to 160 seconds if load current is at 15A, or the maximum source impedance needs to be < 0.13 Ω . Control power input of RM models comply with 61000-3-3 requirements.**

2006/95/EC Low-Voltage Directive

EN 61010-1	2010	Safety Requirements of electrical equipment for measurement, control and laboratory use. Part 1: General requirements
------------	------	--

Compliant with 2002/95/EC RoHS Directive

Per 2002/96/EC W.E.E Directive  Please Recycle Properly

Joe Millanes
Name of Authorized Representative

Winona, Minnesota, USA
Place of Issue

Director of Operations
Title of Authorized Representative

September 2013
Date of Issue

Signature of Authorized Representative

How to Reach Us

Corporate Headquarters

Watlow Electric Manufacturing Company
12001 Lackland Road
St. Louis, MO 63146
Sales: 1-800-WATLOW2
Manufacturing Support: 1-800-4WATLOW
Email: info@watlow.com
Website: www.watlow.com
From outside the USA and Canada:
Tel: +1 (314) 878-4600
Fax: +1 (314) 878-6814

Latin America

Watlow de México S.A. de C.V.
Av. Fundición No. 5
Col. Parques Industriales
Querétaro, Qro. CP-76130
Mexico
Tel: +52 442 217-6235
Fax: +52 442 217-6403

Europe

Watlow France
Tour d'Asnières.
4 Avenue Laurent Cély
92600 Asnières sur Seine
France
Tél: + 33 (0)1 41 32 79 70
Télécopie: + 33(0)1 47 33 36 57
Email: info@watlow.fr
Website: www.watlow.fr

Watlow GmbH
Postfach 11 65, Lauchwasenstr. 1
D-76709 Kronau
Germany
Tel: +49 (0) 7253 9400-0
Fax: +49 (0) 7253 9400-900
Email: info@watlow.de
Website: www.watlow.de

Watlow Italy S.r.l.
Viale Italia 52/54
20094 Corsico MI
Italy
Tel: +39 024588841
Fax: +39 0245869954
Email: italyinfo@watlow.com
Website: www.watlow.it

Watlow Ibérica, S.L.U.
C/Marte 12, Posterior, Local 9
E-28850 Torrejón de Ardoz
Madrid - Spain
T. +34 91 675 12 92
F. +34 91 648 73 80
Email: info@watlow.es
Website: www.watlow.es

Watlow UK Ltd.
Linby Industrial Estate
Linby, Nottingham, NG15 8AA
United Kingdom
Telephone: (0) 115 964 0777
Fax: (0) 115 964 0071
Email: info@watlow.co.uk
Website: www.watlow.co.uk
From outside The United Kingdom:
Tel: +44 115 964 0777
Fax: +44 115 964 0071

Asia and Pacific

Watlow Singapore Pte Ltd.
16 Ayer Rajah Crescent,
#06-03/04,
Singapore 139965
Tel: +65 6773 9488 Fax: +65 6778 0323
Email: info@watlow.com.sg Website: www.watlow.com.sg

Watlow Australia Pty., Ltd.
4/57 Sharps Road
Tullamarine, VIC 3043
Australia
Tel: +61 3 9335 6449
Fax: +61 3 9330 3566
Website: www.watlow.com

Watlow Electric Manufacturing Company (Shanghai) Co. Ltd.
Room 501, Building 10, KIC Plaza
290 Songhu Road, Yangpu District
Shanghai, China 200433
China
Phone
Local: 4006 Watlow (4006 928569)
International: +86 21 3381 0188
Fax: +86 21 6106 1423
Email: info@watlow.cn
Website: www.watlow.cn

ワトロー・ジャパン株式会社
〒101-0047 東京都千代田区内神田1-14-4
四国ビル別館9階
Tel: 03-3518-6630 Fax: 03-3518-6632
Email: infoj@watlow.com Website: www.watlow.co.jp

Watlow Japan Ltd.
1-14-4 Uchikanda, Chiyoda-Ku
Tokyo 101-0047
Japan
Tel: +81-3-3518-6630 Fax: +81-3-3518-6632
Email: infoj@watlow.com Website: www.watlow.co.jp

Watlow Korea Co., Ltd.
#1406, E&C Dream Tower, 46, Yangpyeongdong-3ga
Yeongdeungpo-gu, Seoul 150-103
Republic of Korea
Tel: +82 (2) 2628-5770 Fax: +82 (2) 2628-5771
Website: www.watlow.co.kr

Watlow Malaysia Sdn Bhd
1F-17, IOI Business Park
No.1, Persiaran Puchong Jaya Selatan
Bandar Puchong Jaya
47100 Puchong, Selangor D.E.
Malaysia
Tel: +60 3 8076 8745 Fax: +60 3 8076 7186
Email: vlee@watlow.com
Website: www.watlow.com

瓦特龍電機股份有限公司
80143 高雄市前金區七賢二路189號 10樓之一
電話: 07-2885168 傳真: 07-2885568

Watlow Electric Taiwan Corporation
10F-1 No.189 Chi-Shen 2nd Road Kaohsiung 80143
Taiwan
Tel: +886-7-2885168 Fax: +886-7-2885568

Your Authorized Watlow Distributor

