

# 180/250mm recorders Memory card manual

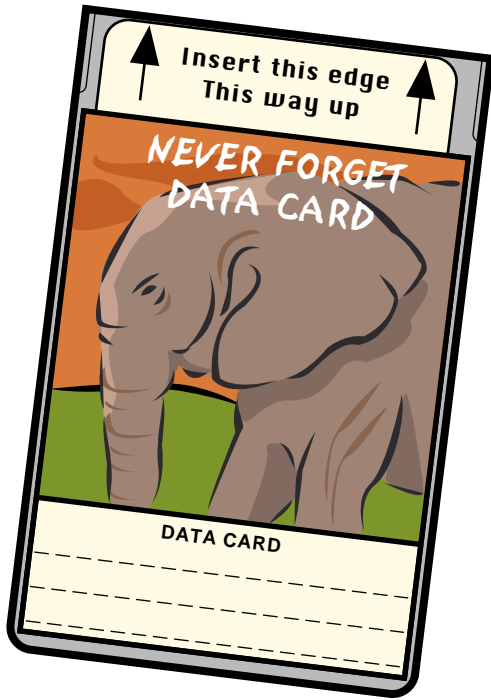

**PCMCIA Version 2 data cards**



# 180/250mm recorders Memory card manual

# How to save a configuration



Use the 'Home' key one or more times to access the 1st Top Level Operator page.

Operator : Select a category  
DISPLAY CHART ALARM CHANNEL MORE>



Operator : Select a category  
PROCESS KEYS TEXT LOG MORE>



Operator : Select a category  
CLOCK JOB SRC SYS ERR CONFIG MORE>



Operator : Select a category  
MEMORY M CARD



Memory card : Select a category  
DIR STATUS CHT CPY OFF LINE MORE>



Memory card : Select a category  
REPORT INTERVL SAVE RESTORE MORE>



Save configuration to *filename.CFG*  
CLEAR SAVE --> NEXT PREVIOUS



If necessary, use NEXT, PREVIOUS and --> softkeys, or keyboard (if fitted) to enter a file name, then operate the SAVE softkey

Overwrite existing file *filename.CFG*  
QUIT CONFIRM



If the file name already exists, overwrite permission will be requested

Saving configuration

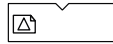

Save configuration to *filename.CFG*  
CLEAR SAVE --> NEXT PREVIOUS

Example: How to save a configuration

© 1998 Eurotherm Recorders Ltd.

All rights are strictly reserved. No part of this document may be reproduced, stored in a retrieval system or transmitted in any form, or by any means, without the prior, written, permission of the copyright owner.

-----

Eurotherm recorders Ltd. reserves the right to alter the specification of its products from time to time without prior notice. Although every effort has been made to ensure the accuracy of the information contained herein, it is not warranted or represented by Eurotherm Recorders Ltd. to be a complete or up-to-date description of the product.



# MEMORY CARD INSTRUCTION MANUAL

## LIST OF CONTENTS

Section	Page
<b>1 INTRODUCTION</b> .....	<b>3</b>
<b>2 BEFORE STARTING</b> .....	<b>3</b>
2.1 MEMORY CARD INSERTION .....	3
2.2 CARD FORMATTING .....	5
2.3 CHANGING CARDS .....	5
<b>3 CONFIGURATION SAVE AND RESTORE</b> .....	<b>6</b>
3.1 SAVE .....	6
3.2 RESTORE .....	6
<b>4 CHART COPY</b> .....	<b>7</b>
4.1 CHT CPY SOFTKEY .....	8
<b>5 DATA LOGGING</b> .....	<b>8</b>
5.1 LOG CONFIGURATION .....	9
5.2 ARCHIVE INTERVAL CONFIGURATION .....	11
5.3 ARCHIVE INTERVAL SELECTION .....	11
<b>6 OPERATOR ACCESS</b> .....	<b>12</b>
<b>7 MEMORY CARD GENERAL FUNCTIONS</b> .....	<b>13</b>
7.1 DIRECTORY .....	13
7.2 CARD STATUS .....	13
7.4 AUTOMATIC FILE DELETION .....	14
<b>8 FILE NAMES</b> .....	<b>14</b>
8.1 TEXT FILE NAMES .....	14
8.2 DAILY FILE NAMES .....	14
8.3 HOURLY FILE NAMES .....	14
8.4 COUNTER FILE NAMES .....	15
8.5 FILE NAME EXTENSIONS .....	15
<b>9 REPORT SOFTKEY</b> .....	<b>16</b>
9.1 REPORT CONTENT .....	16
9.2 REPORT TITLE .....	16
<b>10 OTHER INFORMATION</b> .....	<b>17</b>
10.1 EVENT SOURCES .....	17
10.2 JOBS LIST .....	17
10.3 SYSTEM ERRORS .....	17
10.4 ERROR MESSAGES .....	17
10.5 DIAGNOSTICS .....	19
<b>11 LIST OF EFFECTIVE PAGES</b> .....	<b>23</b>

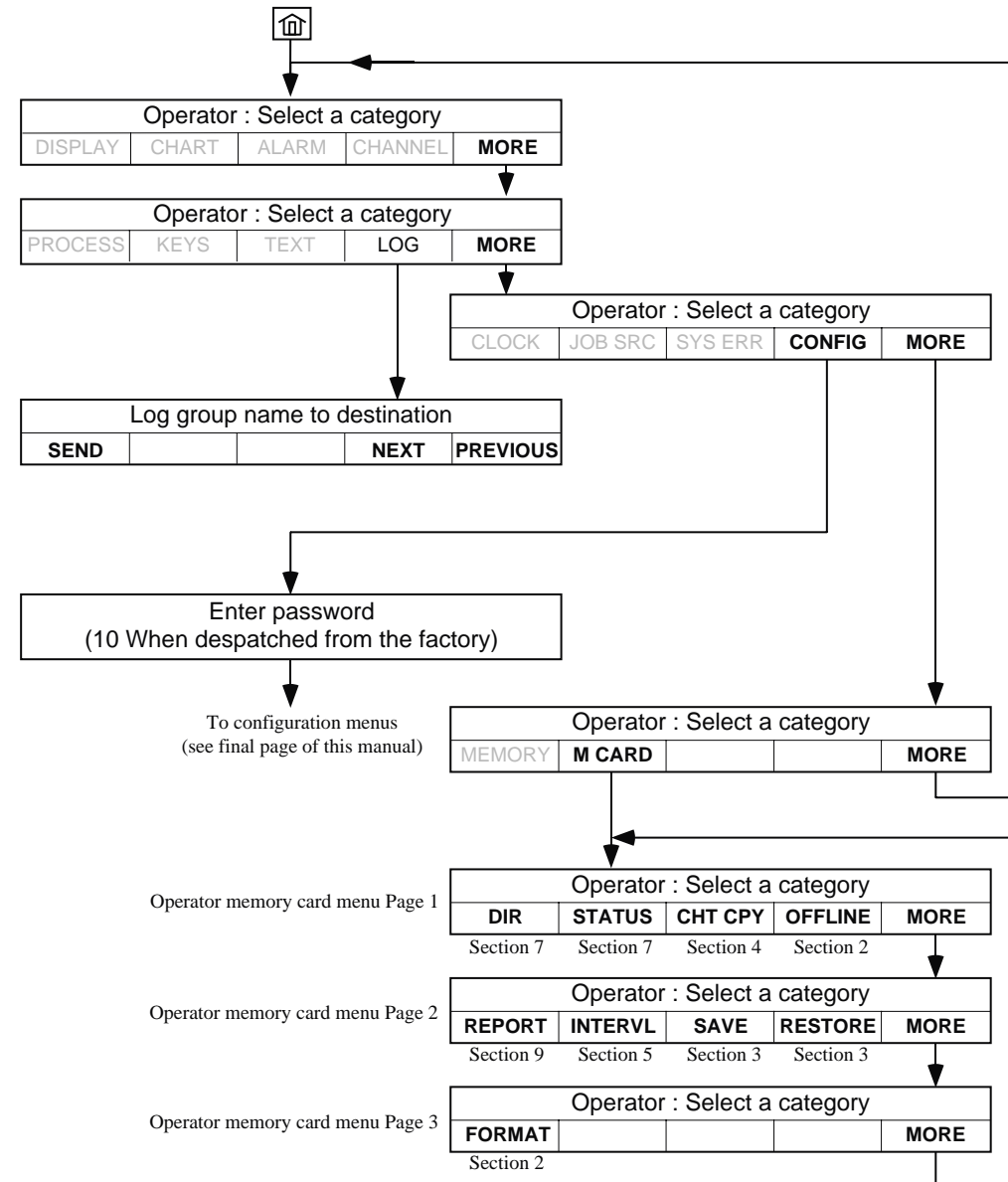

Notes

- 1 The above diagram shows all options available at time of print. Your menu layout will depend on which options are fitted to your recorder.
- 2 Not all recorder models support all the options.

Notes

- 1 The above diagram shows all options available at time of print. Your menu layout will depend on which options are fitted to your recorder.
- 2 Not all recorder models support all the options.

## 1 INTRODUCTION

This document is intended as a supplement to the Installation and operation manuals, for recorders fitted with memory card options. The manual applies to both 180 mm and 250 mm recorders and any features unique to a particular model are pointed out as appropriate.

The expression 'memory card' is used for convenience but, unless otherwise stated, it should be taken to mean SRAM cards, Flash or Hard disk memories according to the option ordered.

This manual describes all possible memory card options - not all are available on all models. It should also be noted that most memory card functions are not accessible to the operator until they have been enabled in the 'Operator Access' configuration as described in section 6.

SRAM cards are fitted with an integral back-up battery. This battery maintains the data for a period which is dependent on card type. The instructions supplied with the card give details of storage periods and battery changing.

Files are stored in DOS format, and the card is PCMCIA version 2 compatible. Configuration software, available from the manufacturer, to run on a PC, can be used in conjunction with the card (and a suitable reader) to create or modify configurations for subsequent down loading to the recorder.

Memory card functions are all available both from the configuration menu and from the operator menu (unless access permission has been denied - see section 6). The major functions of the Memory Card options are:

Configuration card option: Configuration save and restore  
 ASCII log option: As above Configuration card option but with chart copy and ASCII Data logging.  
 Compressed log option: As ASCII log but with PACKED data format and Report Playback facility available.

Review software is available from the manufacturer, and this allows data to be manipulated, traces to be recreated etc. at a standard PC.

## 2 BEFORE STARTING

### 2.1 MEMORY CARD INSERTION

#### 2.1.1 250 mm recorders

As shown in figure 2.1.1, the card is inserted into a slot below the display/keyboard. The card is oriented according to the instructions on its label.

As soon as the card is correctly inserted, the Memory card LED illuminates.

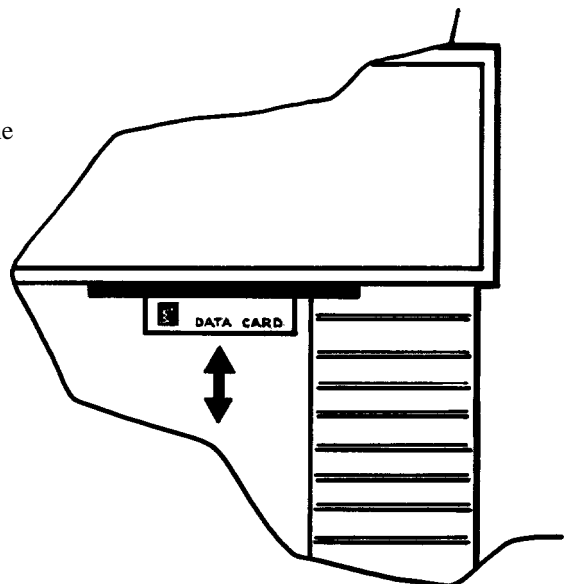

Figure 2.1.1 Memory card insertion - 250 mm recorders

## 2.1.2 180 mm recorders

The Memory card slot is located above and to the left of the chart , as shown in figure 2.1.2

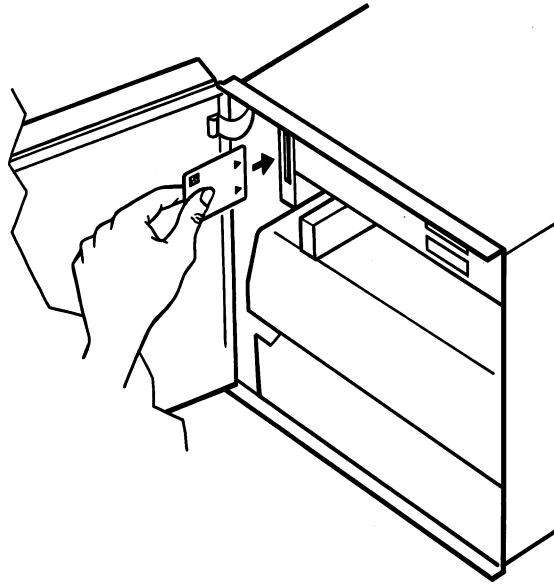

Figure 2.1.2 Memory card insertion - 180 mm recorders

## 2.1.3 Graphics recorders

The memory card is located centrally in the inside of the door (figure 2.1.3). A push button located immediately above\* the card is operated to extract the card.

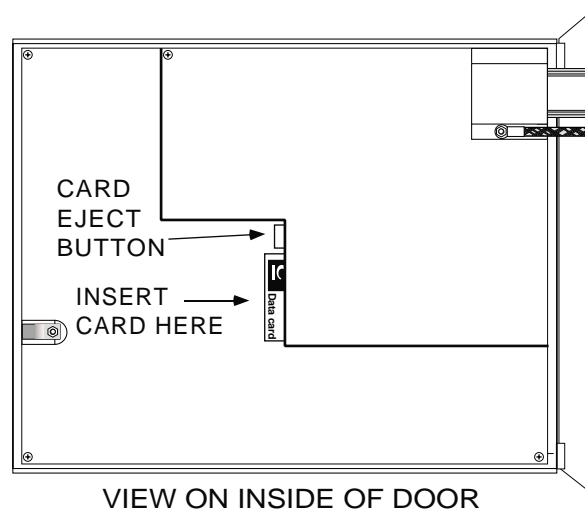

Figure 2.1.3 Memory card location - graphics recorders

\* On previous versions of the recorder, this push-button was located below the card, not above it.



## 2.2 CARD FORMATTING

Before the memory card can be used for the first time, it must be formatted, by operating the FORMAT softkey.

```
Memory card : Select a category
DIR STATUS CHT CPY OFFLINE MORE>
```

```
Memory card : Select a category
REPORT INTRVL SAVE RESTORE MORE>
```

```
Memory card : Select a category
FORMAT
```

### FORMAT

Initiates formatting process. Confirmation is required because all existing data on the card will be deleted. This process takes some seconds.

```
Formatting will erase card data
QUIT CONFIRM
```

Whilst formatting is taking place, a 'Please Wait' message appears at the display, and the Memory card LED flickers (250 mm recorders only).

---

Note: Only the SRAM card is reformatted. Flash and Hard disk memories are not reformatted, but have all their files deleted.

---

## 2.3 CHANGING CARDS

In order to ensure that no corruption of card data takes place whilst changing cards, it is essential that access to the memory card be inhibited whilst card removal / insertion is carried out. This is done by operating the OFFLINE softkey:

```
Memory card : Select a category
DIR STATUS CHT CPY OFFLINE MORE>
```

```
While in this menu
all card access is stopped
```

Once the card has been changed, the CLEAR, HOME or CANCEL key is used to return to on-line status.

### 3 CONFIGURATION SAVE AND RESTORE

#### 3.1 SAVE

Operation of the SAVE softkey calls the first save page:

```
Save configuration to: NNNNNNNN.CFG
CLEAR    SAVE    ->    NEXT  PREVIOUS
```

CLEAR  
SAVE

Used to clear filename completely, or if editing, from the cursor position to the end.  
Saves the recorder's configuration to the file name on the top line of the display. The file name is entered using the NEXT, PREVIOUS and → keys or the alpha-numeric keys of the lower keyboard (if fitted) or Graphics display (if fitted). If the file name already exists in the card, a warning message appears:

```
Overwrite existing file NNNNNNNN.CFG
QUIT  CONFIRM
```

Whilst the configuration is being saved to the card, a 'Saving Configuration' message appears at the display, and the Memory card LED flickers (250 mm recorders only).

→  
NEXT  
PREVIOUS

Used to move the cursor from character to character in the file name.  
Used to scroll forward through the character set to allow editing of the file name.  
Used to scroll backwards through the character set to allow editing of the file name.

#### 3.2 RESTORE

Operation of the RESTORE softkey calls the restore page:

```
Restore configuration from: NNNNNNNN.CFG
RESTORE                      NEXT
```

RESTORE

Reads configuration from the file name on the top line of the display. The file name is selected from those in the card directory, using the NEXT softkey.

Whilst the configuration is being read, a 'Restoring Configuration' message appears at the display, and the Memory card LED flickers (250 mm recorders only)

---

Note: See section 8 for details of file names (Only DOS format file names allowed)

---

4 CHART COPY

 Use the 'Home' key one or more times to access the 1st Top Level Operator page.

Operator : Select a category  
 DISPLAY CHART ALARM CHANNEL MORE>



Operator : Select a category  
 PROCESS KEYS TEXT LOG MORE>



Operator : Select a category  
 CLOCK JOB SRC SYS ERR CONFIG MORE>



Operator : Select a category  
 MEMORY M CARD



Memory card : Select a category  
 DIR STATUS CHT CPY OFF LINE MORE>



Chart copy : Select a category  
 REPLAY ON/OFF

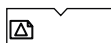

Chart copy to NNNNNNNN.CPY is Off  
 ON OFF FILENAME



If necessary, use field scrollsoftkeys, or keyboard (if fitted) to enter a file name. Use 'Enter' key to confirm changes, then 'Enter' again or 'Cancel' to return to the previous display page.

File name type text NNNNNNNN.CPY



Chart copy to filename.CPY is Off  
 ON OFF FILENAME



Chart copy to filename.CPY is On  
 ON OFF FILENAME

Figure 4 Chart copy to text-type file

### 4.1 CHT CPY SOFTKEY

This feature allows an exact replica of the traces on the chart to be copied to the memory card. The chart can subsequently be replayed (by job or via the Operator menus), on the same recorder or on another recorder of similar type.

Note...

When playing back on a different recorder, this second recorder does not need the same options or channels fitted, or the same configuration as the one that produced the recording; all that is needed is a writing system. Normal operations of the recorder (e.g. alarms) continue to operate as normal.

```
Memory card : Select a category
DIR STATUS CHT CPY OFFLINE MORE>
```

```
Chart Copy : Select a category
REPLAY ON/OFF
```

REPLAY

If currently re-playing a copied chart, the name of the file being replayed appears at the top line of the display. The lower line contains a single softkey (STOP) used to terminate replay. If not re-playing, the name of the currently selected file appears on the top line. The lower line contains two softkeys: START and NEXT. The NEXT key is used to scroll through all the files on the card, and the START softkey is used to initiate replay.

ON/OFF

Operation of this softkey allows chart copying to be switched on and off, and allows a filename to be defined, as described in section 8.

```
Chart copy to NNNNNNNN.CPY is OFF
ON OFF FILENAME
```

ON

Initiates chart copy to the named file.

OFF

Stops chart copy file creation

FILENAME

Allows filename to be entered

### 5 DATA LOGGING

The 'Log' configuration for an instrument with one of the Logging options described below, allows logging to 'file' (i.e. to the memory card) as well as to the chart. This logging to file can be initiated by job or operator action, or, for log 2, automatically at one of two fixed periods (figures 5.2/5.3). The destination of the log (chart or memory card file) is set up as a part of the log configuration. See the Installation and Operation Manual for details of job / operator initiation.

Logging of data in ASCII format is included in the ASCII Log Memory Card option.

A 'Compressed Log Memory Card' option is also available for high density data archiving. Review software is available from the manufacturer, and this allows data to be manipulated, traces to be recreated etc. at a standard PC.

Notes:

1. See section 8 for details of permissible file names / types.
2. Analogue outputs configured as eight-digit integer format will not archive successfully; in order to archive such data, the analogue output *source channel* should be used instead.

## 5.1 LOG CONFIGURATION

With reference to figure 5.1, the following configuration steps are possible:

Log Destination	Required group name To Chart	The field scroll keys are used to scroll through the available groups. Logs selected group to the chart
Include group title	To File	Logs selected group to the memory card
File type	Yes/No	Appears only if 'To Chart' is selected as destination
	ASCII	Produces comma delimited columns of data. File name extension will be .ASC
	PACKED	Proprietary format. Data is stored in a compressed manner which requires a reformatting tool to extract data from it. File name extension will be .PKD
File name type	Text	Fixed file name - see section 8.1.
	Daily	New file opened daily - see section 8.2.
	Hourly	New file opened hourly - see section 8.3.
	Counter	File name takes counter value - see section 8.4.
Include column titles	Yes/No	For ASCII files only. If YES, comma delimited column titles are sent depending on the 'Identify by' and 'Include item units' fields in the Group Format Configuration described in the Installation and Operation Manual supplied with the recorder. (See table 5.1 for examples)
Date format (ASCII)*	DD/MM/YY,HH:MM:SS	First two columns used to specify time and date of archive. (DD/MM/YY might be MM/DD/YY according to the date format selected in Instrument configuration.)
	Spreadsheet	Single, floating-point number. The integer part is the number of days since 31st Dec 1899, the decimal part is the proportion of the day since midnight. For example, Noon on the 1st Jan 1900 would be represented by a value of 1.5, whilst a value of 34121.25 would represent the 6 am on the 1st June 1993.
	Integer	Compresses time and date as YYMMDDHHMMSS, so that 6 am on the 1st June 1993 would be represented as 930601060000.
Compression ratio	Normal	For PACKED data only, compresses the data, but provides an exact copy.
	High	For PACKED data only, compresses the data more than NORMAL. Input channel values are saved to 0.02% accuracy, Totalisers, counters and derived channels are saved to 0.000004% of display accuracy (4 parts in 10 <sup>8</sup> )

\* With maths pack functions, process variables displayed as Date, Time or Elapsed Time, will be logged as follows:

Date format	DD/MM/YY,HH:MM:SS	Date format: Value is logged as DD/MM/YY ( or MM/ DD/YY according to date format selected in Instrument Configuration.)
		Time format: Value is logged as HH:MM:SS
		Elapsed format: Value is logged as HHHH:MM:SS
		Spread sheet Date format: Value is logged as the number of days since the 31st of December 1899
		Time format: Value is logged as a decimal part of a day. E.G. 0.75 = 6 pm.
		Elapsed format: Value is logged as the number of seconds since the time stamp function was initiated.
	Integer	Date format: Value is logged as YYMMDD
		Time format Value is logged as HHMMSS
		Elapsed format: Value is logged as HHHHMMSS

5.1 LOG CONFIGURATION (Cont.)

File of group 'Vessel 1' containing two input channels (12 and 23) including descriptors (TempVes1 and PressVes1) and units (°C and bar respectively), with DD/MM/YY,HH/MM/SS date format. Column headers included:

```
"XXXXA" , , "12" , "23"
"DD/MM/YY" , "HH:MM:SS" , " °C" , "Bar"
"Vessel 1" , , "TempVes1" , "PresVes1"
13/02/94,12:15:06,28.93,0.989
13/02/94,12:16:04,28.71,0.963
```

(Where XXXXA is the recorder model number)

File of group 'Vessel 1' containing two input channels (12 and 23) NOT including descriptors, units or tags with DD/MM/YY,HH/MM/SS date format. Column headers included:

```
"XXXXA" , , "12" , "23"
,,
"Vessel 1" , ,
13/02/94,12:15:06,28.93,0.989
13/02/94,12:15:06,28.71,0.963
```

(Where XXXXA is the recorder model number)

Table 5.1 Examples of ASCII format files

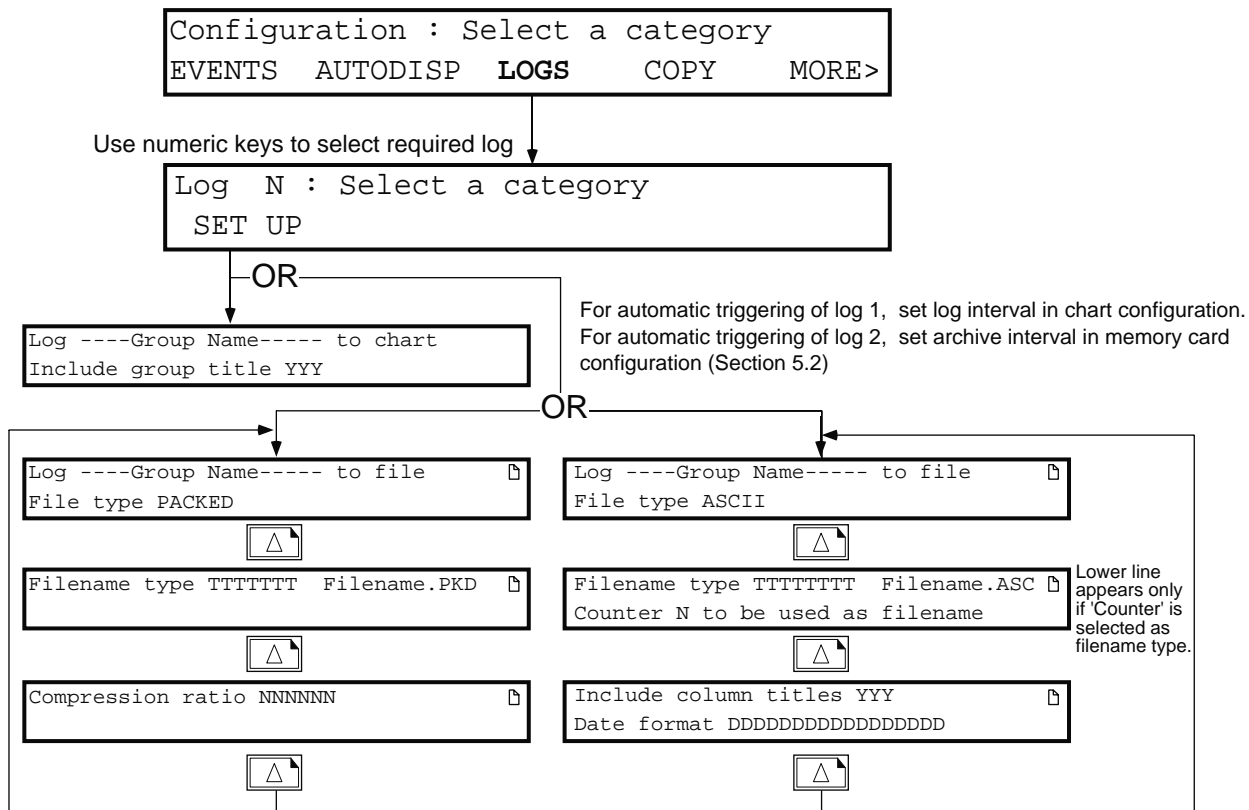

Figure 5.1 Typical Log Configuration pages

## 5.2 ARCHIVE INTERVAL CONFIGURATION

Use the cursor and numeric entry keys to enter Intervals A and B (if required) for automatic triggering of log 2. An entry of 00:00:00 causes the automatic triggering to be inhibited. Interval A / B selection is either by job or operator action.

If a 'round figure' value (e.g. 10 mins, 20 mins) is entered, the recorder will start its interval logging at the next whole 10-minutes.

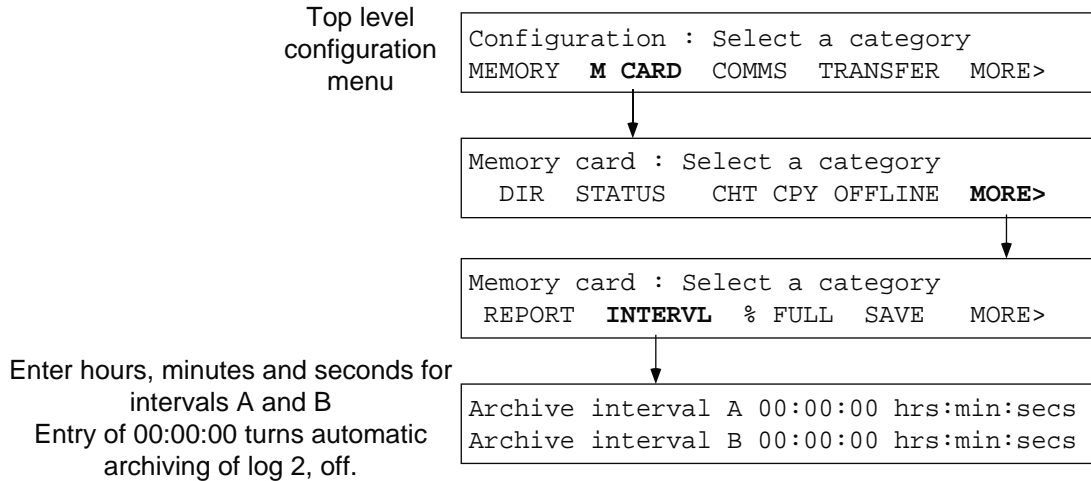

Figure 5.2 Archive interval configuration

## 5.3 ARCHIVE INTERVAL SELECTION

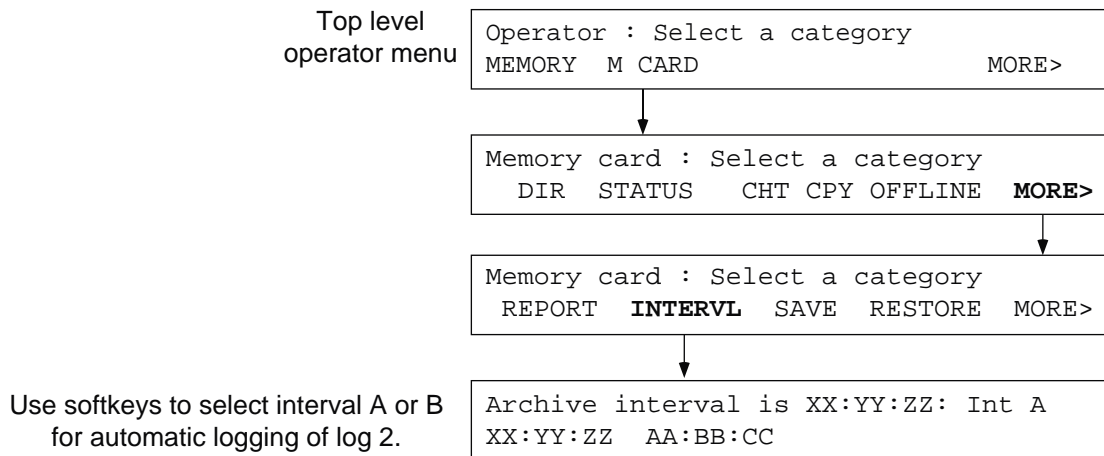

Figure 5.3 Operator selection of archive interval

## 6 OPERATOR ACCESS

Each of the memory card functions can be password protected using the OPERATOR ACCESS part of the recorder configuration. Refer to the Operator Access description in the Configuration section of the Installation and Operation manual for further details. If all functions are protected, the M CARD softkey does not appear in the Operator Menu.

Operator permissions :Select a category TIMER MEMORY M CARD MORE>
Memory card : Allow operator to:- Format no Save no Restore no
Memory card : Allow operator to:- Display Status/Dir yes Delete no
Memory card : Allow operator to:- Configure report no
Memory card : Allow operator to:- Replay no Stop replay no
Memory card : Allow operator to:- Change archive interval no
Memory card : Allow operator to:- Chart copy: Control no Change file no
Memory card : Allow operator to:- Turn memory card offline no

Use 'Page' key to scroll through pages.

The use of the cursor and field scroll keys allow the access permissions to be toggled between 'Yes' and 'No'.

Note: Which of the above display pages appear, depends on which options are fitted. If an option (e.g. chart copy) is not fitted, then it does not appear in the scroll list.



## 7 MEMORY CARD GENERAL FUNCTIONS

```
Memory card : Select a category
DIR STATUS CHT CPY OFFLINE MORE>
```

### 7.1 DIRECTORY

The DIR softkey allows the user to scroll through the file names held in the card memory and to delete files as required.

```
NNNNNNNN.NNN SSSSSS DD/MM/YY HH:MM
DELETE NEXT
```

The top line of the display contains the first file name (NNNNNNNN . NNN) its size in Bytes (SSSSSS) and the date and time of its creation.

DELETE

Operation of this key calls a confirmation page:

```
Delete file NNNNNNNN.NNN
QUIT CONFIRM
```

CONFIRM

Deletes the file from the card memory.

NEXT

Repeated operation of this key allows the other file names in the directory to be scrolled through.

### 7.2 CARD STATUS

The STATUS softkey calls the following display page:

```
Size : sssssK Free : fffffK
Write protected : YYY
```

This display tells the user the card's total memory size in kBytes, how many kBytes remain unused and whether the card is write protected (YYY = Yes) or not (YYY = No).

It should be noted that a newly formatted card uses some space for format data,

```
Memory card : Select a category
DIR STATUS CHT CPY OFFLINE MORE>
```

```
Memory card : Select a category
REPORT INTERVL % FULL SAVE MORE>
```

```
Memory card full limit 80%
```

In the Configuration menus the 'Memory card full limit' page depicted above can be used to set a percentage level. If the amount of data stored on the card exceeds this value, an internal event is triggered. This event can be used to operate an alarm to tell the operator that the card needs replacing.

In the Operator menu, the % FULL softkey does not appear.

## 7.3 AUTOMATIC FILE DELETION

Should the card become full whilst chart copy or data logging / archiving activities are being carried out, the oldest chart copy or data logging / archiving file on the card is deleted. (The oldest file will be deleted whether or not it is of the same type as the one being written.) **Existing configuration files (.CFG) are not deleted.**

Should the card become full whilst a Configuration Save is being attempted the Save will be aborted. Existing files are not deleted.

## 8 FILE NAMES

The following types of file name may be used when storing data on the memory card.

1. Text
2. Daily (Uses the recorder's real-time clock)
3. Hourly (Uses the recorder's real-time clock)
4. Counter value.

The file names consist of eight characters, followed by a three-character non-editable extension.

### 8.1 TEXT FILE NAMES

```
Filename type Text _____ NNNNNNNN.XXX
```

With 'Filename type' scrolled to 'Text', the NN—NN field can be freely edited with alpha-numeric characters as follows: ! # \$ % & ( ) - 0 to 9 @ A to Z ^ \_ ' a to z { } ~

**The use of any other character (including blank) will result in the file name being rejected.**

### 8.2 DAILY FILE NAMES

With 'Filename type' scrolled to 'Daily', the file name changes format:

```
Filename type Daily ____ NNYMMDD.XXX
```

Only the first two characters (NN) can be edited; the remainder of the file name will be the date on which the file was initiated. Thus if a chart copy were started some time on the 3rd of August 1993, then the file name would be NN930803.CPY. If the copy were not stopped, the NN930803.CPY file would be closed at midnight, and a new file opened with file name NN930804.CPY.

### 8.3 HOURLY FILE NAMES

Hourly filenames are similar to daily filenames except that they are closed on the hour, instead of at midnight.

```
Filename type Hourly ____ NNMMDDHH.XXX
```

Only the first two characters (NN) can be edited. The remainder of the file name will be the time and date on which the copy was initiated. Thus if a chart copy were started some time between nine and ten a.m. on the 3rd of August, then the file name would be NN080309.CPY. If the copy were not stopped, the NN080309.CPY file would be closed at 10:00 am, and a new file opened with file name NN080310.CPY.

## 8.4 COUNTER FILE NAMES

With 'Filename type' scrolled to 'Counter', the file name changes format:

Filename type <u>Counter</u> 00000000.XXX Counter NN to be used as filename
--

None of the filename characters can be edited; the file name being the value of counter NN. This allows, for example, a separate chart copy to be made for individual batches, if counter NN is set up to hold the batch number.

Should the counter is incremented during data transfer, the file will be closed at an appropriate point, and a new file opened with the counter's new value for a file name.

## 8.5 FILE NAME EXTENSIONS

All chart copy files are appended with a CPY extension. All logging file names have extensions ASC or PKD according as they are ASCII or PACKED format (See section 5).

If a chart copy is attempted to a file which already exists, then the extension is 'incremented' from CPY to CP1. If CP1 also exists, the extension will be incremented to CP2, CP3 — C10 — 100, and so on (up to 999), until an unused file name is found. ASC and PKD extensions are treated in exactly the same way.

Configuration file names (.CFG extensions) are different in that if an attempt is made to create a configuration file which already exists, a warning message appears asking for overwrite permission, and if this is given, the existing file will be overwritten and lost.

## 9 REPORT SOFTKEY

The report facility allows one or more Chart Copy (.CPY) files to be replayed to the recorder as many times as required.

```
Memory card : Select a category
DIR STATUS CHT CPY OFFLINE MORE>

Memory card : Select a category
REPORT INTERVL % FULL SAVE MORE>

Chart Replay Report RRRRRRRRRRRRRRRRRRRR
REPLAY CONTENT TITLE NEXT PREVIOUS
```

RR—RR is the name of the currently selected report. NEXT and PREVIOUS can be used to scroll through the list of reports. Operation of the REPLAY softkey allows the selected report's files to be replayed, or any current replay to be terminated.

### 9.1 REPORT CONTENT

```
Chart Replay Report RRRRRRRRRRRRRRRRRRRR
REPLAY CONTENT TITLE NEXT PREVIOUS

SSSSSSSSSSSSSSSSSSSSSS NNNNNNNN.XXX
Replayed N times
```

Operation of the CONTENT softkey allows the filename (NNNNNNNN), which is to be included in the selected report, to be edited. The star or asterisk character (\*) can be used within the file name as 'any character'. For example a file name RN\*\*\*\*\* will include all file names starting with RN.

The SS—SS field can be scrolled to one of the values listed below, in order to limit the number of files to be replayed.

- |                           |   |
|---------------------------|---|
| Latest M files matching   | M can be defined as 1 to 9, so that only the last few files which match the requested filename are included.      |
| Todays files matching     | Includes all files which match the requested filename which have been created since the previous midnight.        |
| This weeks files matching | Includes all files which match the requested filename which have been created since midnight the previous Sunday. |
| All files matching        | Includes all files which match the requested file name.   |

The final field 'Replayed N times' allows the entire report to be played out automatically, up to 9 times.

### 9.2 REPORT TITLE

```
Chart Replay Report RRRRRRRRRRRRRRRRRRRR
REPLAY CONTENT TITLE NEXT PREVIOUS

Report title is RRRRRRRRRRRRRRRRRRRR
```

Operation of the TITLE softkey allows the report name (RR—RR) to be edited.

## 10 OTHER INFORMATION

### 10.1 EVENT SOURCES

The following event sources are added to the recorder:

1. Memory card battery low
2. Memory card battery exhausted
3. Card full
4. Card nearly full
5. MCC Overdrive error (Archiving buffer full)
6. File replaying

These can be used to initiate recorder jobs as described in the Installation and Operation Manual. Figure 10.2 (below) shows all the memory card option additions to the jobs list. Note the new facility to be able to send a message to memory card.

### 10.2 JOBS LIST

The new job list together with trigger sources is shown in figure 10.2 below.

---

Note: To send a message to the memory card the destination file must be PACKED format. If not, the message is lost. I.E. ASCII format messages will not be stored.

---

### 10.3 SYSTEM ERRORS

The following possible system errors are added to the recorder:

1. Memory card battery low
2. Memory card battery flat
3. MCC Overdrive error (Archiving buffer full)

Any of these will cause the system error LED (250 mm recorders only) to be illuminated, a message to be sent to the display and an entry to be placed in the system error list (see the Installation and Operation Manual).

### 10.4 ERROR MESSAGES

In the event of an error occurring during card use, a message will appear for a few seconds. The following error messages are possible:

Directory empty	Card reader fault
Card write protected	Card read failure
Card changed	Card write failure
Card not formatted	Bad filename
Card not fitted	Card data corrupted
File write protected	Card full
File read protected	MCC overdrive

10 OTHER INFORMATION (Cont.)

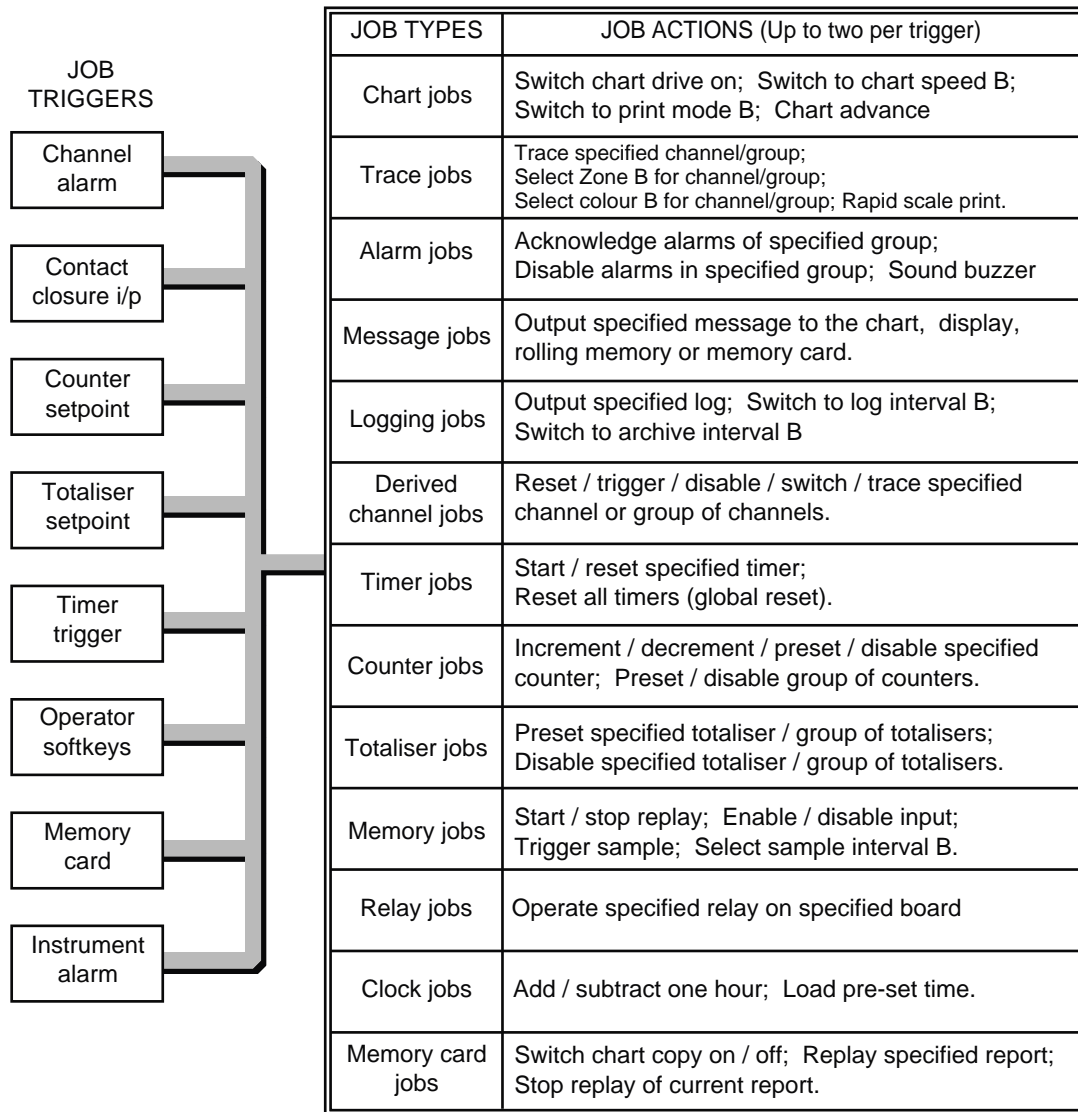

Figure 10.2 Jobs list

## 10.5 DIAGNOSTICS

Memory card diagnostics are entered via the M CARD softkey in the top-level diagnostics menu, and allow the memory card to be tested to determine whether it is operating correctly.

---

Note: **The test erases card data. Ensure only 'scratch' memory cards are used.**

---

Operation of the M CARD softkey causes the first of the memory card diagnostics pages to be entered:

```
Card type must be SRAM Size sssssK
TEST  VERSION
```

Where sssss is the card size which must be entered by means of the numeric key pad.

TEST        Initiates card testing:

```
Memory card test will erase card data
QUIT  CONFIRM
```

CONFIRM    Allows card test to be carried out. During the test, a 'Please wait' message will be displayed. At the end of the test the following page is called to the display:

```
Memory card test PPPP
```

Where PPPP is either 'pass' or 'fail'

VERSION    Allows the version of memory card controller PCB software to be determined:

```
Memory card controller SW VERSION 1.1
QUIT
```

This page is deliberately left blank



# CONFIGURATION MENUS

Option softkeys (e.g. MATHS, CHT CPY) appear only if the relevant option is fitted. For this reason your display pages might differ from those shown here.

From operator menus - see page 2

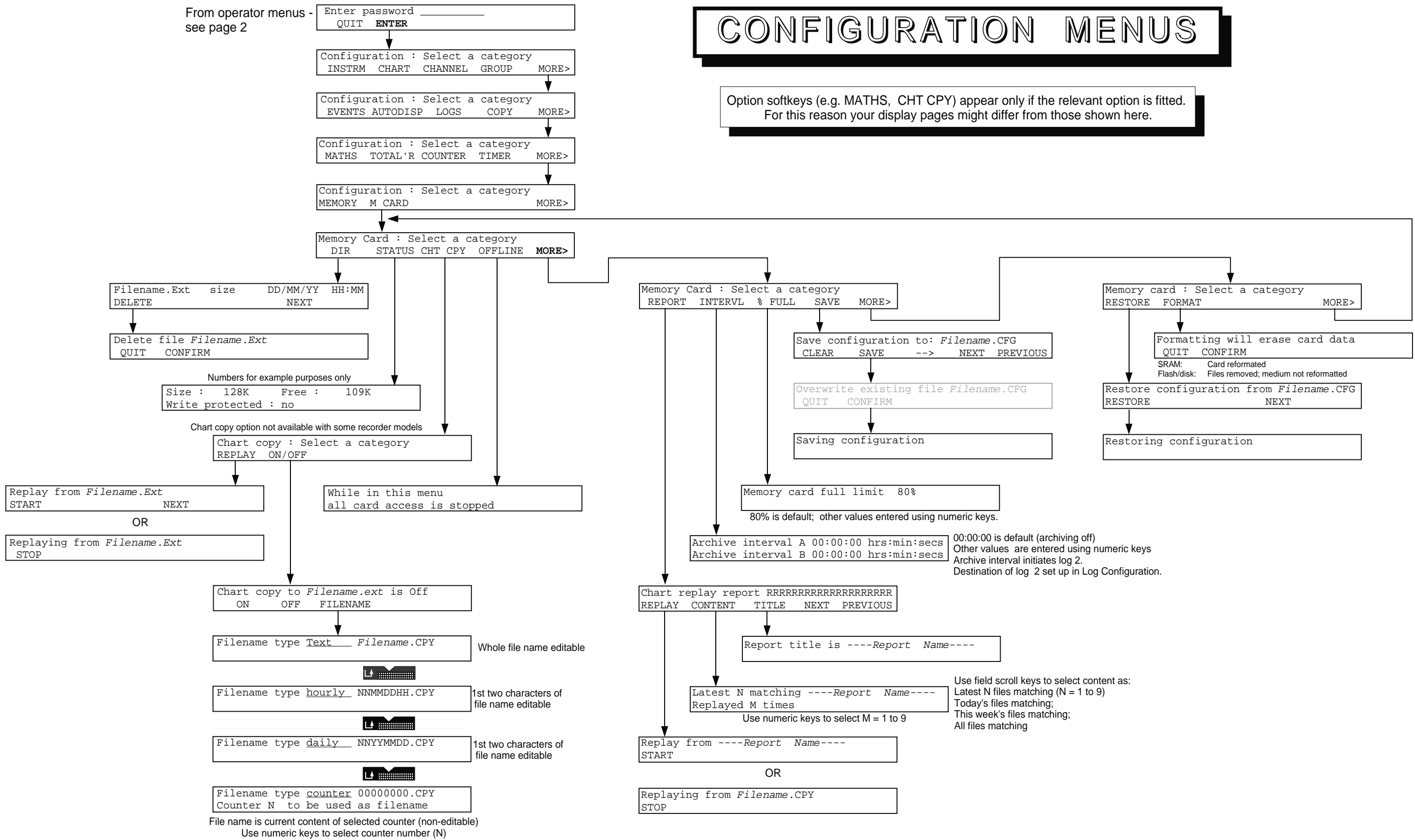

This page is deliberately left blank

## 11 LIST OF EFFECTIVE PAGES

This (issue 6) manual consists of the pages listed below, at their stated revision levels.

Page 1 .....	Issue 6 Jly 98
Page 2 .....	Issue 6 Jly 98
Page 3 .....	Issue 6 Jly 98
Page 4 .....	Issue 6 Jly 98
Page 5 .....	Issue 6 Jly 98
Page 6 .....	Issue 6 Jly 98
Page 7 .....	Issue 6 Jly 98
Page 8 .....	Issue 6 Jly 98
Page 9 .....	Issue 6 Jly 98
Page 10 .....	Issue 6 Jly 98
Page 11 .....	Issue 6 Jly 98
Page 12 .....	Issue 6 Jly 98
Page 13 .....	Issue 6 Jly 98
Page 14 .....	Issue 6 Jly 98
Page 15 .....	Issue 6 Jly 98
Page 17 .....	Issue 6 Jly 98
Page 18 .....	Issue 6 Jly 98
Page 19 .....	Issue 6 Jly 98
Page 20 .....	Issue 6 Jly 98
Page 21 .....	Issue 6 Jly 98
Page 22 .....	Issue 6 Jly 98
Page 23 .....	Issue 6 Jly 98



# Operator initiation of ASCII Log

 Use the 'Home' key one or more times to access the 1st Top Level Operator page.



```
Operator : Select a category
DISPLAY  CHART  ALARM  CHANNEL  MORE>

```

```
Operator : Select a category
PROCESS  KEYS   TEXT   LOG   MORE>

```

```
Operator : Select a category
CLOCK   JOB SRC  SYS ERR CONFIG  MORE>

```

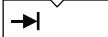

```
Enter password _____
QUIT  ENTER

Key-in the password (10 when despatched from the factory)
then operate the 'Enter' key
```

```
 Configuration : Select a category
INSTRM  CHART  CHANNEL  GROUP  MORE>

```

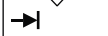
```
Configuration : Select a category
EVENTS  AUTODISP  LOGS   COPY  MORE>

```

```
Log 1 : Select a category
SET UP

```

```
Log Everything _____ to chart
Include group title yes
  
```





Use cursor key and field scroll keys to change 'to chart' to 'to file'.

```
Log Everything _____ to file
File type ASCII

```

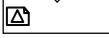
Use the cursor key to move to the file name field. Use either NEXT and PREVIOUS softkeys or the lower keyboard (if fitted) to enter the file name.





```
File name type TEXT _____ NNNNNNNN.ASC
  
```

Then use the page key to call the next page.

```
 Include column titles Yes
Date format Spreadsheet
  
```

Use the cursor key and field scroll keys to select column titles and date format.

Use the 'Enter' key to confirm the changes, then use the 'Home' key twice to return to the Operator menu.

```
  
Operator : Select a category
DISPLAY  CHART  ALARM  CHANNEL  MORE>

Operator : Select a category
PROCESS  KEYS   TEXT   LOG   MORE>

```

```
Log Everything _____ to filename.ASC
SEND _____ NEXT PREVIOUS

```

**Example: Operator initiation of an ASCII log of group 'Everything'.  
(Adds a row of data to the data file)**

