



**EUROTHERM
PROCESS
AUTOMATION**

**6370/80
series
intelligent
loop
processors**

**reference
manual**



6370/80 Series INTELLIGENT LOOP PROCESSORS

Reference Manual Supplement

Issue 5 Release 1 Software

Eurotherm Process Automation pursues a policy of continuous development and product improvement. The specifications in this document may therefore be changed without notice. The information in this document is given in good faith, but is intended for guidance only. Eurotherm Process Automation will accept no responsibility for any losses arising from errors in the document.

Issue C October 1992

Part Number HA 079575 U 003/SUPPLEMENT

EUROTHERM PROCESS AUTOMATION LIMITED

SOUTHDOWNVIEW WAY, WORTHING, WEST SUSSEX BN14 8NN

TELEPHONE: 0903 205277 FAX: 0903 233902 TELEX: 87437



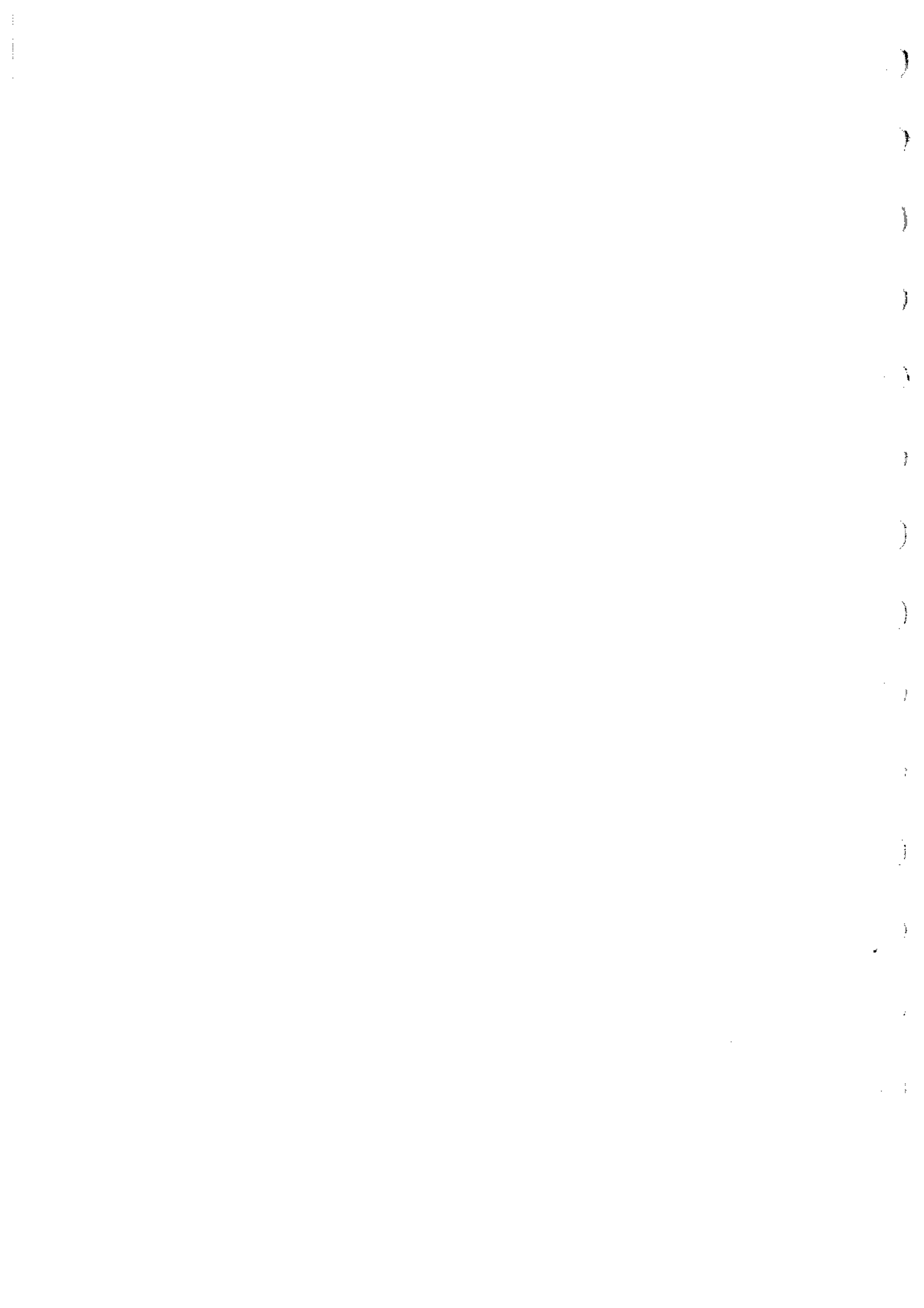

Supplement Introduction

RELEASE 5 CHANGES & ADDITIONS

This supplement should be read in conjunction with the *6370/80 Series Intelligent Loop Processors Reference Manual Issue 5/B*, and applies to all instruments in the series.

Supplement Chapter S1 GENERAL DESCRIPTION

This chapter contains revisions to Chapter 1 of the Issue 5/B Reference Manual.

Introduction to the Series

Configurations are not downloadable from a supervisory system at Issue 5.

Block Structure

Table 1.1 on page 1.2 is altered. The 6370 and 6380 instruments now have 13 Library Functions.

Supplement Chapter S2 6370/80 SERIES FRONT PANELS

There is no change to the information contained in Chapter 2 of the Issue 5/B Reference Manual.

Supplement Chapter S3 THE 8263 HAND-HELD TERMINAL

This chapter contains revisions to Chapter 3 of the Issue 5/B Reference Manual.

Test Probe

To aid debugging of user configurations an assignable TEST PROBE has been added. This can be accessed via the 8263 Hand-Held Terminal or, for full benefits, via TCS 8280 LoopDraw software.

The test probe can be 'attached' to the destination end of any connection in the running strategy, where it monitors the analogue or digital data passing through the connection and displays the value as a floating point number at the bottom right of the HHT window.

To activate the probe type '!' (Shift, then G) from any HHT prompt (?? CMD, ?? BCMD or ?? BCL Ln SC OK), followed by the destination of the connection to be probed. E.g. to monitor the signal passing through the connection

```
011B -> 021A
01=SLCT 02=MPLY
```

type the following (do not press the load character 'L'):

```
!021A
```

The value coming from the connection's source then appears in the HHT window, and the prompt returns:

```
??BCL L1 SC OK
12.34
```

NOTE. The test probe can be assigned only to a block *input*, not to an output.

The probe display updates more than four times a second, whilst all other HHT functions continue as normal. This means you can adjust block parameters, simultaneously observing the effect of the changes. The probe value is obscured only in ?? BCL mode when connections are being displayed across the full window — but it reappears as soon as the prompt returns. The probe display is floating point, with as many decimal places as the value allows, and digital values are represented as .0000 (for LOW) or .0001 (for HIGH).

To move the probe to another connection repeat the above procedure — the existing display is automatically replaced. To clear the probe, simply type '!' followed by the load character 'L'.

Trying to attach the probe to an unconnected destination clears the probe display. Trying to reassign the probe to a non-existent destination also clears the probe display, but then typing 'Z' reinstates the previous probed connection.

Supplement Chapter S4 FIXED FUNCTION BLOCKS

This chapter contains revisions to Chapter 4 of the Issue 5/B Reference Manual.

The following Fixed function blocks have been affected by the changes in Issue 5:

XPID, RPID, XCON, RCON, ALRM, DISP, GENP.

XPID, RPID, XCON, RCON

Refer to the 6370/80 Series Reference Manual Chapter 4, page 4.37 onwards for details of control blocks and to Chapter 7 for discussion of the PID algorithm.

The following change is common to all these Control Blocks.

New Connections

A new input connection has been added to these blocks, called II (Integral Balance Inhibit on XP changes). When a digital connection to this input is high, changes of XP (Proportional Band) do not trigger integral balances (see Chapter 7). The value of this input can be seen (but not changed) in bit 12 of the control blocks' 3T parameters. This feature allows continuously varying XP values to be used — for adaptive gain applications — without causing repeated integral balancing (see Chapter 7).

6370/80 REFERENCE

NOTE. Integral balancing should be permitted under certain circumstances to prevent undesirable output bumps. E.g.:

- if large XP changes occur (such as when the function generating XP is changed)
- if XP changes occur when the error is small
- if the XP is a function of ER, when integral balancing should be allowed at, and just after, setpoint changes.

ALRM

Refer to the 6370/80 Series Reference Manual Chapter 4, page 4.116 onwards, for details of the ALRM block.

New Connections

Four new input connections have been added to this block to allow access to the alarm trip points. They have the same names as the associated parameters:

H1	High alarm 1 trip point
L1	Low alarm 1 trip point
H2	High alarm 2 trip point
L2	Low alarm 2 trip point

DISP

Refer to the 6370/80 Series Reference Manual Chapter 4, page 4.109 onwards, for details of the DISP block.

New Connections

Seven new input connections have been added to this block to improve access to the third display. Six are to allow control of the mode indication LEDs on the pushbuttons:

Connection	Action when High
RL	illuminate 'R' LED
AL	illuminate 'A' LED
ML	illuminate 'M' LED
RF	flash 'R' LED if illuminated (i.e. if RL high)
AF	flash 'A' LED if illuminated (i.e. if AL high)
MF	flash 'M' LED if illuminated (i.e. if ML high)

The seventh, called FD (Filter Disable) disables the 1-second filter on the digital display (when FD is high). This allows the display to be switched between two or more values without a filtering delay and allows the pushbuttons to be used to manipulate values displayed. If unconnected, the above inputs default to low.

New Functions

The decimal point position of the instrument's front panel digital display (driven by DD) can be allowed to 'float' by entering a value of 5 in digit D of the DISP block's ST parameter. The displayed decimal point position then depends on the value connected to DD.

NOTE. When this feature is active the *Hand-Held Terminal* can only display the DD parameter correctly for values $\leq .9999$. DD values greater than this are all displayed as '.9999'.

GENP

Refer to the 6370/80 Series Reference Manual Chapter 4, page 4.85 onwards, for details of the GENP block.

New Connections

A new input connection has been added to this block called CD (Computer Disable). While a connection to CD is high, no parameters can be changed via RS422 binary communications to loops 1 or 2 (see Chapter 8). Hence supervisory operation and control are prevented, but reading the parameters is still possible as normal.

CD connects to bit 15 of parameter ST of the GENP block. If no connection is made, bit 15 can be changed to unconditionally disable comms writes, by either the HHT or comms.

Two new output connections have been added: CT (Comms Timeout), and HT (Hand-Held Terminal Timeout). The CT output connection goes high if the RS422 communications to the instrument have been inactive for 10 seconds, or if the HHT is connected. The HT output connection is high if the HHT is not plugged in, or if it has been inactive for 10 seconds. The values of these outputs can be seen in bit 14 (CT) and bit 13 (HT) of the GENP block's ST parameter.

Further Information on Fixed Function Blocks

TOTL

In the Totalisation Block Schematic (Figure 4.44, page 4.103) FT also resets to 0 in the 'Initialise' operation, as correctly described in the text following the Figure.

6370/80 REFERENCE

GENP

L1 & L2 Loop 1 & Loop 2 Repeat Times (page 4.91)

Parameters L1 and L2 cannot be permanently altered from the HHT or serial Data Link as they are updated every time the loop is run.

Supplement Chapter S5 ASSIGNED FUNCTION BLOCKS

This chapter contains revisions to Chapter 5 of the Issue 5/B Reference Manual.

The 6370 and 6380 instruments have now been up-issued to Issue 5.1. One extra assigned block (SLCT) has been added to the 6370 and 6380 libraries to increase them to 13 blocks.

In Table 5.1 on page 5.2, the SLCT block should now appear above the dashed line.

The following Assigned Function blocks have been affected by the changes in Issue 5:

AND2, AND4, RATE, RAMP, PCNT, AOCB, DOCB.

AND2/AND4

Refer to the 6370/80 Series Reference Manual Issue 5/B Chapter 5, page 5.23 onwards, for details of logic blocks, and page 5.4 for a comment on default input values.

New Functions

The inputs to AND blocks now default to high, so unused inputs can be left unconnected, and the AND function will apply to the connected inputs.

RATE

Refer to the 6370/80 Series Reference Manual Issue 5/B Chapter 5, page 5.39 onwards, for details of the RATE block.

New Functions

Extra timebases have been added to this block, selected via bits 1 and 0 in the ST parameter:

Bits	Hex Value	Timebase Selected
0 0	0	seconds
0 1	1	minutes
1 0	2	hours
1 1	3	<i>(invalid — defaults to seconds)</i>

RAMP

Refer to the 6370/80 Series Reference Manual Issue 5/B Chapter 5, page 5.43 onwards, for details of the RAMP block.

New Functions

Extra timebases have been added to this block, selected via bits 1 and 0 in the ST parameter, as for the RATE block just described.

The 'on-target' flags RD and ND are no longer frozen in TRACK and HOLD — so they always compare RO with TA regardless of block mode.

PCNT

Refer to the 6370/80 Series Reference Manual Issue 5/B Chapter 5, page 5.55 onwards, for details of the PCNT block.

New Connections

A new input connection has been added to this block called 3C, which is linked to bit 0 of the ST parameter. When this bit is low the block operates as already described in the Manual. When it is high the block resets to the value in EP, and counts down, the count end flag being set when zero is reached. If unconnected, bit 0 can be set via the HHT.

New Functions

The reset function can now be accessed via the HHT (by setting bit 6 of the ST parameter high) as well as via a connection.

6370/80 REFERENCE

AOCB

Refer to the 6370/80 Series Reference Manual Issue 5/B Chapter 5, page 5.68 onwards, for details of the AOCB block.

New Connections

A new input connection has been added to this block called WP (Write Protect), which is linked to bit 15 of the ST parameter (read-only). When a connection to WP is high no parameters in the block can be changed via RS422 binary communications (see Chapter 8). This prevents supervisory control but reading the parameters is still possible as normal.

Another new input connection, 1A, allows the output to be updated from the strategy, but *only when WP is high*. This can be used to greatly ease bumpless transfer to and from supervisory control.

DOCB

Refer to the 6370/80 Series Reference Manual Issue 5/B Chapter 5, page 5.75 onwards, for details of the DOCB block.

New Connections

A new input connection has been added to this block called WP (Write Protect), which is linked to bit 15 of the ST parameter (read-only). When a connection to WP is high no parameters in the block can be changed via RS422 binary communications (see Chapter 8). This prevents supervisory control but reading the parameters is still possible as normal.

Further Information on Assigned Function Blocks

SAMP

1K, 2K, 3K, 4K Constants (page 5.22)

The block input/output order is important if the block is used as a shift register. Input 1A is read then 1K is updated, input 2A is read then 2K is updated, and so on.

Supplement Chapter S6 COMMAND MODE PARAMETERS

There is no change to the information contained in Chapter 6 of the Issue 5/B Reference Manual.

Supplement Chapter S7 CONTROL LOOP OPERATING MODES

This chapter contains revisions to Chapter 7 of the Issue 5/B Reference Manual.

Conditions Triggering Integral Balance Application (page 7.13)

At Issue 5, XP (Proportional Band) changes can be inhibited by holding the new II input connection to the control block high. This fact also bears on the last sentence of the section *Integral Balance & Adaptive Gain Control*, on page 7.14. Continuous XP variation can be used with Issue 5 software, with integral balancing inhibited via II.

Supplement Chapter S8 COMPUTER SUPERVISION OF INTELLIGENT LOOP PROCESSORS

This chapter contains revisions to Chapter 8 of the Issue 5/B Reference Manual.

Functions of Motherboard Switchbank SW2, Switches 5 & 6

At Issue 5, switch 5 of SW2 applies to 6370/80 instruments as well. The NOTE following Table 8.1 on page 8.8 should now read:

'Table 8.1 applies to 6372/82 instruments, which have two loops and pseudo I/O communications blocks, enabling them to emulate up to eight I/O Boards of the 6432 instrument. For 6370/80 instruments, set switch 5 'ON' to access Loop 1 parameters (the only loop). Switch 6 is not used in the 6370/80 and has no effect. When II is set to 3568 or 3668, switch 6 is 'don't care' and switch 5 is OFF for 1 loop, ON for 2 loops.'

6370/80 REFERENCE

Supplement Chapter S9 TASK SCHEDULING

This chapter contains revisions to Chapter 9 of the Issue 5/B Reference Manual.

Reducing Loop Repeat Times (page 9.4)

NOTE. The loop repeat rate can be fixed for one loop only — either L1 or L2.

Supplement Chapter S10/11/Appendix A

There is no change to the information contained in Chapters 10, 11 and Appendix A of the Issue 5/B Reference Manual.

6370/80 Series INTELLIGENT LOOP PROCESSORS

Reference Manual

Eurotherm Process Automation pursues a policy of continuous development and product improvement. The specifications in this document may therefore be changed without notice. The information in this document is given in good faith, but is intended for guidance only. Eurotherm Process Automation will accept no responsibility for any losses arising from errors in the document.

Issue 5/B October 1992

Part Number HA 079575 U 003

EUROTHERM PROCESS AUTOMATION LIMITED

SOUTHDOWNVIEW WAY, WORTHING, WEST SUSSEX BN14 8NN
TELEPHONE: 0903 205277 FAX: 0903 233902 TELEX: 87437



6370/80 REFERENCE

TCS Intelligent Instruments are products of Eurotherm Process Automation Limited.
TCS is a registered trademark of Eurotherm Process Automation Limited.

All other registered and unregistered trademarks are properties of their respective holders.

CONTENTS

	<i>page</i>
Chapter 1	GENERAL DESCRIPTION <i>1.1</i>
	Introduction to the Series <i>1.1</i>
	Hardware Organisation <i>1.5</i>
	Mechanical Structure <i>1.6</i>
	Functional Descriptions, Boards & Circuit Blocks <i>1.7</i>
Chapter 2	6370/80 SERIES FRONT PANELS <i>2.1</i>
	Power-On Indicator(s) <i>2.1</i>
	Positive & Negative Deviation Bargraphs <i>2.2</i>
	HOLD & TRACK Mode Indicators <i>2.3</i>
	Digital Readout <i>2.4</i>
	Output Bargraph <i>2.6</i>
	Loop 2 & Loop 1 Display Indicators <i>2.6</i>
	Process Variable (PV) Bargraph <i>2.6</i>
	Setpoint (SP) Bargraph <i>2.7</i>
	Pushbuttons <i>2.7</i>
	Altering Normal Pushbutton Functions <i>2.7</i>
	Manual Mode Select <i>2.8</i>
	Auto(matic) Mode Select <i>2.8</i>
	Remote/Ratio Mode Select <i>2.8</i>
	Setpoint Display <i>2.8</i>
	Setpoint Adjustment <i>2.8</i>
	Controller Output Adjustment <i>2.9</i>
	Process Alarm Settings <i>2.9</i>
	Displayed Loop & Display Mode Selector <i>2.9</i>
	Hand-Held Terminal Socket <i>2.10</i>
Chapter 3	THE 8263 HAND-HELD TERMINAL <i>3.1</i>
	Terminal Features <i>3.1</i>
	Terminal Setup <i>3.2</i>
	Cable & Plug <i>3.2</i>
	Display <i>3.3</i>
	Keyboard <i>3.4</i>
	ASCII Codes <i>3.5</i>
	Terminal Initialisation <i>3.6</i>

	<i>page</i>
Terminal Modes	3.7
Command Mode – ?? CMD	3.9
Accessing a Parameter	3.9
Example 1: Accessing II Parameter	3.9
Keying In a Parameter Value	3.10
Example 2: Keying in II value	3.10
Loading a Parameter Value	3.11
Example 3: Loading II Parameter	3.11
Terminal Control Keys	3.11
Block Command Mode – ?? BCMD	3.12
Installing an Assigned Block	3.12
Example 4: Assigning ADD2 block	3.12
Installing a Control Block	3.14
Accessing Block Parameters	3.14
Example 5: Accessing Parameter HR	3.15
Entering a Parameter Value	3.16
Example 6: Writing to Parameter HR	3.16
Assigned Blocks Scroll Keys	3.18
Block Connection Mode – ?? BCL	3.19
The Block Interconnection Mode Prompt	3.19
Configuring a Block Interconnection	3.20
Example 7: Interconnecting blocks	3.20
Reviewing & Editing Existing Block Interconnections	3.21
Example 8: Reviewing & Editing	3.23
Deleting a Single Interconnection	3.24
Deleting All Interconnections	3.24
Block Execution Auto-Prioritisation	3.25
Control Program Execution	3.25
Interconnection Destination Query	3.26
Terminal Control Keys – Q, W, Z	3.27
Backspace/Refresh Key – Q	3.27
Scroll Key – W	3.28
Mode Prompt – Z	3.29
Parameter Formats	3.30
Parameter Type	3.30
Range & Polarity	3.30
Decimal Point Position	3.31
Hand-Held Terminal Error Conditions	3.32

	<i>page</i>
Chapter 4	
FIXED FUNCTION BLOCKS	4.1
Key to Block Connection Diagrams	4.3
Key to Parameter Diagrams	4.4
Key to Data Format Symbols	4.6
ANIN: Analogue Input Block	4.7
Block Function	4.7
Block Connections	4.7
Block Parameters	4.9
STBlock Status	4.9
Decimal Point Selection — Digit A	4.9
Input Processing Routines — Digit B	4.9
Input Filter Time — Digit C	4.12
Status Bits — Digit D	4.12
HR & LR Analogue Input Ranging	4.12
AI Analogue Input	4.13
AV Analogue Variable	4.13
ANOP: Analogue Output Block	4.14
Block Function	4.14
Block Connections	4.15
Block Parameters	4.17
STBlock Status	4.17
Decimal Point Selection — Digit A	4.18
Inverse Output Select(ed) — Digit C	4.18
Status Bits — Digit D	4.18
HR & LR Analogue Output Ranging	4.18
HL & LL Analogue Output Limits	4.19
AO Analogue Output	4.19
FC Function Control Register	4.19
Loop Number Selection — Digits A & B	4.20
Priority Number Selection — Digits C & D	4.20
DGIN: Digital Input Block	4.21
Block Function	4.21
Block Connections	4.22
Block Parameters	4.23
ST Block Status	4.24
Status Bit — Digit D	4.24
XM Exclusive-OR Mask	4.24
DS Digital Input States	4.25

	<i>page</i>
DGOP: Digital Output Block	4.26
Block Function	4.26
Block Connections	4.27
Block Parameters	4.28
ST Block Status	4.28
WM Write Mask	4.29
DS Digital Output States	4.29
FC Function Control Register	4.30
MANS: Manual Station Block	4.31
Block Function	4.31
Block Connections	4.32
Block Parameters	4.34
ST Block Status	4.34
HV & LV Output Incremental & Decremental Rate Lims.	4.35
HL & LL Output Limits	4.35
MO Manual Station Output	4.35
OP Output Demand	4.35
OT Output Track Value	4.35
MP Manual Station Display	4.36
FC Function Control Register	4.36
XPID: Control Block	4.37
Block Function	4.37
Block Connections	4.40
Block Parameters	4.42
ST Block Status	4.43
Decimal Point Selection — Digit A	4.43
Setpoint Operating Mode — Digit B	4.43
Alarm Outputs — Digit C	4.44
Status Bit — Digit D	4.44
PH & PL Setpoint & Process Variable Ranging	4.45
HS & LS Setpoint Limits	4.45
HA & LA Absolute Alarm Limits	4.45
HD & LD Deviation Alarm Limits	4.46
SL Local Setpoint	4.46
SR Remote Setpoint	4.46
SB Setpoint Bias	4.47
ER Error Value	4.47
RL Setpoint Rate Limit	4.47

	<i>page</i>
3T PID Status	4.47
Integral Balance Input Status — Digit A	4.47
Time Constants Units — Digit B	4.48
PID Operation & Status — Digit C	4.48
Shutdown & Power-Up Action — Digit D	4.49
XP Proportional Band Constant	4.50
TI & TD Integral & Derivative Time Constants	4.50
TS Algorithm Sampling Period	4.51
FF Feedforward Term	4.51
FB Feedback Term	4.51
OP PID Control Output	4.52
SP Resultant Internal Setpoint	4.52
PV Process Variable	4.52
ES Enable Status	4.52
Individual Bit Masks — Digits A & B	4.52
Control Loop Operating Mode — Digits C & D	4.53
Use of the ES Parameter — Examples	4.55
MD Loop Operating Mode	4.55
Control Loop Operating Mode — Digits A, B, & C	4.56
Control Loop Operating Mode Number — Digit D	4.56
SM Front Panel Pushbutton Mask	4.57
FC Function Control Register	4.58
XCON: Control Block	4.59
Block Function	4.59
Block Connections	4.60
Block Parameters	4.63
3T PID Status	4.64
FF Feedforward Term	4.64
MO Control Output	4.64
OP Output Demanded	4.65
RPID: Ratio Control Block	4.66
Block Function	4.66
Operating Modes	4.67
RATIO Mode	4.67
RATIO Mode Inoperative	4.68
Block Connections	4.70
Block Parameters	4.73
MD Loop Operating Mode	4.74
Control Loop Operating Mode — Digits A, B, & C	4.74

	<i>page</i>
Control Loop Operating Mode Number — Digit D	4.75
RA Ratio Status	4.76
Decimal Point Selection — Digit A	4.76
Ratio Mode — Digit B	4.76
Ratio Sense — Digit D	4.76
HR & LR Ratio Setting Limits	4.77
SR Ratio Setpoint	4.77
RS Ratio Setting	4.78
RT Ratio Trim	4.78
RB Ratio Bias	4.78
RCON: Ratio Control Block	4.79
Block Function	4.79
Block Connections	4.80
Block Parameters	4.83
GENP: General Purpose Block	4.85
Block Function	4.85
Block Connections	4.85
Block Parameters	4.87
ST Block Status	4.88
Hardware Status — Digits A & B	4.88
Program Status — Digit C	4.89
Block Status — Digit D	4.90
ID Instrument Identity (Read-Only)	4.90
II Instrument Identity (Read-Write)	4.90
PI Program Identifier	4.91
L1 & L2 Loop 1 and Loop 2 Repeat Times	4.91
SI, AA '6432' Instrument Pseudo I/O Parameters	4.91
P1 to P8 Pseudo Comms Setup	4.91
Block Type — Digit A	4.92
Channel Quantity — Digit B	4.92
Communications Address (INO) — Digits C & D	4.92
FC Function Control Register	4.93
LLAG: Lead/Lag (Filter) Block	4.94
Block Function	4.94
Block Connections	4.95
Block Parameters	4.96
ST Block Status	4.96
Filter Operating Mode — Digits B & C	4.96
Block Status — Digit D	4.97

	<i>page</i>
XK Filter Gain	4.97
1T & 2T Filter Time Constants	4.97
FF Feedforward / Output Bias	4.98
FI Filter Input	4.98
OPFilter Output	4.98
FC Function Control Register	4.98
DTIM: Deadtime Block	4.99
Block Function	4.99
Block Connections	4.100
Block Parameters	4.101
ST Block Status	4.101
Delay Operating Mode — Digit C	4.102
Block Status — Digit D	4.102
MT Maximum Delay Time	4.102
DT Delay Time	4.102
FC Function Control Register	4.102
TOTL: Totalisation Block	4.103
Block Function	4.103
Block Connections	4.104
Block Parameters	4.105
ST Block Status	4.106
FS Decimal Point — Digit A	4.106
Pulse Data — Digit B	4.106
Totalisation Operating Mode — Digit C	4.106
Block Status & Units Select — Digit D	4.107
FS Flow Scaling Factor	4.107
FT Flow Total	4.108
FC Function Control Register	4.108
DISP: Display Block	4.109
Block Function	4.109
Block Connections	4.110
Block Parameters	4.111
ST Block Status	4.112
Decimal Point Selection — Digits A to D	4.112
Bargraph Flash Select — Digits A to C	4.112
1H & 1L Bargraph 1 High & Low Ranging	4.112
1B Bargraph 1 Variable	4.114
2H & 2L Bargraph 2 High & Low Ranging	4.114
2B Bargraph 2 Variable	4.114
3H & 3L Bargraph 3 High & Low Ranging	4.114

	<i>page</i>
3B Bargraph 3 Variable	4.115
DD Digital Display Variable	4.115
FC Function Control Register	4.115
ALRM: Alarm Block	4.116
Block Function	4.116
Block Connections	4.117
Block Parameters	4.118
ST Block Status	4.118
Decimal Point Selection — Digit A	4.119
Alarm Status — Digit C	4.119
Block Status & Alarm Type — Digit D	4.119
H1 & L1 First High & Low Alarm Levels	4.119
H2 & L2 Second High & Low Alarm Levels	4.120
PV Alarm Process Variable	4.120
SP Alarm Setpoint	4.120
HY Alarm Hysteresis	4.121
FC Function Control Register	4.121
CHAR: Characteriser Block	4.122
Block Function	4.122
Block Connections	4.122
Block Parameters	4.123
ST Block Status	4.123
Decimal Point Selection — Digits A & B	4.123
Block Status — Digit D	4.124
AI Input Data	4.124
OX to FX X-Axis Co-ordinates	4.124
OY to FY Y-Axis Co-ordinates	4.124
FC Function Control Register	4.124
Chapter 5	
ASSIGNED FUNCTION BLOCKS	5.1
Key to Block Connection Diagrams	5.3
Default Values	5.4
Ranges of Analogue Inputs & Outputs	5.4
MATHS BLOCKS: Arithmetic	5.5
ADD2: Add	5.5
SUBT: Subtract	5.5
MPLY: Multiply	5.5
DIVD: Divide	5.5
AVG2: Average	5.5
Block Connections	5.5

	<i>page</i>
Block Functions	5.5
Block Parameters	5.6
ST Block Status	5.6
1K & 2K Scaling Constants	5.7
FC Function Control Register	5.7
MATHS BLOCKS: Trigonometric	5.8
SIN: Sine	5.8
COS: Cosine	5.8
TAN: Tangent	5.8
Block Connections	5.8
Block Functions	5.8
Block Parameters	5.9
ST Block Status	5.9
FC Function Control Register	5.10
MATHS BLOCKS: Operators	5.11
ROOT: Square Root	5.11
EXP: Exponential	5.11
ABS: Absolute Value	5.11
NEGT: Negation	5.11
NLOG: Natural Logarithm	5.11
Block Connections	5.11
Block Functions	5.11
Block Parameters	5.12
MATHS BLOCKS: Operators (two inputs)	5.13
EXPN: Exponent	5.13
Block Connections	5.13
Block Function	5.13
Block Parameters	5.13
MATHS BLOCKS: Operators	5.14
INT: Integer	5.14
Block Function	5.14
Block Connections	5.14
Block Parameters	5.15
MATHS BLOCKS: Operators	5.16
RANG: Range & Limit	5.16
Block Function	5.16
Block Connections	5.16

	<i>page</i>
Block Parameters	5.17
ST Block Status	5.17
Decimal Point Selection — Digits A & B	5.18
Block Status — Digit D	5.18
IH & IL Input High & Low Ranges	5.18
OH & OL Output High & Low Ranges	5.18
IP Input Value	5.18
OP Output Value	5.18
FC Function Control Register	5.18
CONSTANTS BLOCKS	5.19
CONS: Constants	5.19
Block Connections	5.19
Block Parameters	5.19
ST Block Status	5.20
1K, 2K, 3K, 4K Constants	5.20
CONSTANTS BLOCKS	5.21
SAMP: Read/Write Constants	5.21
Block Connections	5.21
Block Parameters	5.21
ST Block Status	5.22
1K, 2K, 3K, 4K Constants	5.22
FC Function Control Register	5.22
LOGIC BLOCKS: Gates	5.23
AND2: AND	5.23
OR2: OR	5.23
XOR2: XOR	5.23
AND4: AND (4-input)	5.23
OR4: OR (4-input)	5.23
NOT: NOT	5.23
LTCH: Latch	5.23
Block Connections	5.23
Block Functions	5.25
Block Parameters	5.26
LOGIC BLOCKS: Comparators	5.27
GT: Greater Than	5.27
LT: Less Than	5.27
Block Connections	5.27
Block Functions	5.27

	<i>page</i>
Block Parameters	5.28
ST Block Status	5.28
Decimal Point Selection — Digits A to C	5.28
HY Hysteresis	5.29
LOGIC BLOCKS: Comparators	5.30
EU: Equal	5.30
Block Connections	5.30
Block Functions	5.30
Block Parameters	5.31
ST Block Status	5.31
Decimal Point Selection — Digits A to C	5.32
HY Hysteresis	5.32
EB Equal Band	5.32
SELECTOR BLOCKS	5.33
HSL2: High Select	5.33
LSL2: Low Select	5.33
Block Connections	5.33
Block Functions	5.33
Block Parameters	5.34
SELECTOR BLOCKS	5.35
MSL3: Median Select	5.35
Block Connections	35
Block Functions	5.35
Block Parameters	5.36
ST Block Status	5.36
SELECTOR BLOCKS	5.37
SLCT: Select	5.37
Block Connections	5.37
Block Function	5.37
Block Parameters	5.38
TIME BLOCKS	5.39
RATE: Rate Limit	5.39
Block Function	5.39
Block Connections	5.39
Block Parameters	5.40
ST Block Status	5.41
Decimal Point Selection — Digit A	5.41

	<i>page</i>
On-Target Flag — Digit B	5.41
Timer Reset & Rate Limit Disable — Digit C	5.41
Block Status — Digit D	5.41
HV & LV Output Incremental & Decremental Rate Lims.	5.42
TA Target Value	5.42
RO Output Value	5.42
FC Function Control Register	5.42
TIME BLOCKS	5.43
RAMP	5.43
Block Function	5.43
Block Connections	5.43
Block Parameters	5.44
ST Block Status	5.45
Decimal Point Selection — Digit A	5.45
On-Target Flag — Digit B	5.45
Hold/Track Selects & Timer Reset — Digit C	5.45
Block Status — Digit D	5.46
RL Rate Limit	5.46
TA Target Value	5.46
OT Track Value	5.46
RO Output Value	5.46
FC Function Control Register	5.46
TIME BLOCKS	5.47
TIME: Timer	5.47
Block Function	5.47
Block Connections	5.47
Block Parameters	5.48
ST Block Status	5.49
Timer Reset — Digit C	5.49
Block Status & Timer Units — Digit D	5.49
ET End-Time	5.49
FC Function Control Register	5.49
TIME BLOCKS	5.50
PGNT: Pulse Generator	5.50
Block Function	5.50
Block Connections	5.50
Block Parameters	5.51
ST Block Status	5.52
Decimal Point Selection — Digits A & B	5.52

	<i>page</i>
Block Reset — Digit C	5.52
Block Status — Digit D	5.53
1K & 2K Scaling Factors	5.53
MM & MS Minimum 'Mark' & 'Space' Times	5.54
FC Function Control Register	5.54
COUNT BLOCKS	5.55
PCNT: Pulse Counter	5.55
Block Function	5.55
Block Connections	5.55
Block Parameters	5.56
STBlock Status	5.57
Decimal Point Selection — Digits A & B	5.57
Block Status — Digit D	5.57
1K Scaling Factor	5.57
EP End Pulse Value	5.58
FC Function Control Register	5.58
MAX/MIN BLOCKS	5.59
PEAK: Peak Detect (Max/Min)	5.59
Block Function	5.59
Block Connections	5.59
Block Parameters	5.60
STBlock Status	5.61
Mode Select — Digit B	5.61
Block Status — Digit D	5.61
FC Function Control Register	5.61
PSEUDO I/O BLOCKS	5.62
Pseudo I/O Blocks Comms Addresses	5.62
AICB: Single-Channel Pseudo Analogue Input Block	5.63
Block Function	5.63
Block Connections	5.63
Block Parameters	5.64
ST Block Status	5.64
Decimal Point Selection — Digit A	5.64
Status Bit — Digit D	5.64
IN Block Identity	5.65
Block Type — Digit A	5.66
Channel Number — Digit B	5.66
Communications Enable & Address — Digits C & D	5.66
HR & LR Pseudo Analogue Input Ranging	5.66

	<i>page</i>
AV Analogue Variable	5.67
FC Function Control Register	5.67
AOCB: Single-Channel Pseudo Analogue Output Block	5.68
Block Function	5.68
Block Connections	5.68
Block Parameters	5.69
ST Block Status	5.69
IN Block Identity	5.69
HR & LR Pseudo Analogue Output Ranging	5.70
HO & LO Analogue Output Limit	5.70
AO Analogue Output	5.70
FC Function Control Register	5.70
DICB: Eight-Channel Pseudo Digital Input Block	5.71
Block Function	5.71
Block Connections	5.71
Block Parameters	5.72
ST Block Status	5.72
IN Block Identity	5.72
WM Write Mask	5.73
DS Digital Input States	5.74
FC Function Control Register	5.74
DOCB: Eight-Channel Pseudo Digital Output Block	5.75
Block Function	5.75
Block Connections	5.75
Block Parameters	5.76
ST Block Status	5.76
IN Block Identity	5.76
XM Exclusive-OR Mask	5.76
DS Digital Output States	5.77
FC Function Control Register	5.77
Chapter 6 COMMAND MODE PARAMETERS	6.1
Command Mode Parameters	6.1
II Instrument Identity (Read/Write)	6.2
ID Instrument Identity (Read-Only)	6.3
PI Program Identifier	6.3
SW Motherboard Switch Settings	6.3
PB Front Panel Pushbutton Status	6.4
Front Panel Status — Digits C & D	6.4
SC Fixed Block(s) in Sumcheck Error	6.5

	<i>page</i>
P1 to P8 Pseudo Comms Setup	6.5
LT Lamp Test	6.5
LN Loop Number	6.5
E1, E2 EEPROM Stored Program Identifiers	6.6
FX Store/Recall Database	6.6
Storing a Configuration	6.6
Recalling a Configuration	6.7
CI Clear Instrument	6.8
Chapter 7 CONTROL LOOP OPERATING MODES	7.1
Mode Entry & Operating Characteristics	7.3
Control Loop Example	7.6
Default Mode	7.8
6370/80 Series 3-Term Control Algorithm	7.10
Integral Balance & Integral Desaturation	7.12
Integral Balance	7.12
Integral Desaturation	7.14
Mathematical Implementation	7.18
Chapter 8 COMPUTER SUPERVISION OF INTELLIGENT LOOP PROCESSORS	8.1
Serial Data Communications	8.2
Communications Protocol	8.3
ASCII Protocol	8.4
Binary Protocol	8.6
Instrument Parameter Numbers	8.9
Chapter 9 TASK SCHEDULING	9.1
Task 1 — RS422 Supervisory Communications	9.1
Task 2 — Instrument Real I/O Updates	9.2
Task 3 — Maintenance Routines	9.2
User Task 1 — Loop 1 Block-Structured Program	9.2
User Task 2 — Loop 2 Block-Structured Program	9.3
User Task 3 — Background Program	9.3
Excessive Loop Repeat Times & Watchdog Failure	9.4
Connecting Blocks Between Loops —	
Task Scheduling Implications	9.5

	<i>page</i>
Chapter 10 ERROR MESSAGES & DIAGNOSTICS	10.1
1 Initialisation Error	10.4
2 Illegal Parameter Mnemonic	10.4
3 Illegal Data Entry	10.4
4 Illegal Load Key	10.4
5 Illegal Input to Read-Only Parameter	10.5
6 Invalid or Out-of-Range Data	10.5
7 Undefined Interconnection Address	10.5
8 Illegal Block Loop Numer	10.6
9 Invalid Connection Mnemonic	10.6
10 Program Write-Protect Active	10.7
11 EEPROM Write-Protect Active	10.8
12 Function Block Sumcheck Error	10.8
Chapter 11 SPECIFICATIONS	11.1
Analogue Inputs (ANIN Blocks)	11.1
Analogue Outputs (ANOP Blocks)	11.3
Digital Inputs (8-Way DGIN Block)	11.4
Digital Outputs (8-Way DGOP Block)	11.5
Control Block (XPID)	11.5
Control Block (XCON)	11.6
Ratio Control Block (RPID)	11.6
Ratio Control Block (RCON)	11.6
Manual Station Block (MANS)	11.7
General Purpose Block (GENP)	11.7
Lead/Lag Block (LLAG)	11.7
Deadtime Block (DTIM)	11.8
Totalisation Block (TOTL)	11.8
Display Block (DISP)	11.8
Alarm Block (ALRM)	11.9
Characteriser Block (CHAR)	11.9
Assigned Blocks	11.9
Timing Accuracy — All Timer Blocks	11.11
Communications Blocks (AICB, AOCB, DICB, DOCB)	11.11
Operator Front Panel Displays	11.12
Operator Front Panel Controls	11.13
Power Supplies	11.14
RFI Susceptibility	11.14
System Grounding	11.16
Physical Specification	11.16
8263 Hand-Held Terminal	11.17

	<i>page</i>
Ordering Codes	<i>11.17</i>
Warranty & After-Sales Service	<i>11.17</i>
Documentation & Software Issue Definition	<i>11.18</i>
 APPENDIX A	
	<i>A.1</i>
 INDEX	
	<i>IND.1</i>

LIST OF FIGURES

	<i>Page</i>	
Fig 1.1	6370/80 Series Intelligent Loop Processors	1.1
Fig 1.2	Intelligent Loop Processor Hardware Block Schematic	1.4
Fig 1.3	6370/80 Series Internal Structure	1.7
Fig 2.1	6370 Front Panel	2.2
Fig 2.2	6372 Front Panel	2.3
Fig 2.3	6380 Front Panel	2.4
Fig 2.4	6382 Front Panel	2.5
Fig 3.1	The 8263 Hand-Held Terminal	3.2
Fig 3.2	8263 Cable Wiring & Pin Designations	3.3
Fig 3.3	8263 Display	3.3
Fig 3.4	8263 Hand-Held Terminal Keyboard	3.4
Fig 3.5	8263 Hand-Held Terminal ASCII Codes	3.5
Fig 3.6	Hand-Held Terminal Modes	3.7
Fig 3.7	Interconnection Types	3.22
Fig 4.1	Key to Block Connection Diagrams	4.3
Fig 4.2	Symbols used in Parameter Diagrams	4.4
Fig 4.3	Analogue Input Block Schematic	4.7
Fig 4.4	Analogue Input Block Connections	4.7
Fig 4.5	ST Parameter — Analogue Input Block	4.10
Fig 4.6	Analogue Output Block Schematic	4.14
Fig 4.7	Analogue Output Block Connections	4.15
Fig 4.8	ST Parameter — Analogue Output Block	4.17
Fig 4.9	FC Parameter — Analogue Output Block	4.20
Fig 4.10	Digital Input Block Schematic	4.21
Fig 4.11	Digital Input Block Connections	4.22
Fig 4.12	ST Parameter — Digital Input Block	4.24
Fig 4.13	XM Parameter — Digital Input Block	4.25
Fig 4.14	DS Parameter — Digital Input Block	4.25
Fig 4.15	Digital Output Block Schematic	4.26
Fig 4.16	Digital Output Block Connections	4.27
Fig 4.17	WM Parameter — Digital Output Block	4.29

	<i>page</i>
Fig 4.18 DS Parameter — Digital Output Block	4.30
Fig 4.19 Manual Station Block Schematic	4.31
Fig 4.20 Manual Station Block Connections	4.32
Fig 4.21 XPID Block Schematic	4.37
Fig 4.22 XPID Block Connections	4.40
Fig 4.23 ST Parameter — XPID Control Block	4.44
Fig 4.24 3T Parameter — XPID Control Block	4.48
Fig 4.25 ES Parameter — XPID Control Block	4.53
Fig 4.26 MD Parameter — XPID Control Block	4.55
Fig 4.27 SM Parameter — XPID Control Block	4.57
Fig 4.28 XCON Block Schematic	4.59
Fig 4.29 XCON Block Connections	4.60
Fig 4.30 RPID Block Schematic	4.66
Fig 4.31 RPID Block Connections	4.70
Fig 4.32 MD Parameter — RPID Ratio Control Block	4.74
Fig 4.33 RA Parameter — RPID Ratio Control Block	4.77
Fig 4.34 RCON Block Schematic	4.79
Fig 4.35 RCON Block Connections	4.80
Fig 4.36 GENP Block Connections	4.85
Fig 4.37 ST Parameter — General Purpose Block	4.88
Fig 4.38 P1 to P8 Parameter (Pn) — General Purpose Block	4.92
Fig 4.39 Lead/Lag (Filter) Block Schematic	4.94
Fig 4.40 LLAG Block Connections	4.95
Fig 4.41 ST Parameter — Lead/Lag (Filter) Block	4.97
Fig 4.42 Deadtime Block Schematic	4.99
Fig 4.43 DTIM Block Connections	4.100
Fig 4.44 ST Parameter — Deadtime Block	4.101
Fig 4.45 Totalisation Block Schematic	4.103
Fig 4.46 TOTL Block Connections	4.104
Fig 4.47 ST Parameter — Totalisation Block	4.106
Fig 4.48 Display Block Schematic	4.109
Fig 4.49 DISP Block Connections	4.110
Fig 4.50 ST Parameter — Display Block	4.112
Fig 4.51 Bargraph 3 Display Ranges	4.115
Fig 4.52 Alarm Block Schematic	4.116
Fig 4.53 ALRM Block Connections	4.117
Fig 4.54 ST Parameter — Alarm Block	4.118
Fig 4.55 CHAR Block Connections	4.122
Fig 4.56 ST Parameter — Characteriser Block	4.123

	<i>page</i>	
Fig 5.1	Key to Block Connection Diagrams	5.3
Fig 5.2	Connections for Arithmetic Blocks	5.5
Fig 5.3	ST Parameter — Arithmetic Blocks	5.6
Fig 5.4	Connections for Trigonometric Blocks	5.8
Fig 5.5	ST Parameter — Trigonometric Blocks	5.9
Fig 5.6	Connections for Operator Blocks	5.11
Fig 5.7	Exponent Block Connections	5.13
Fig 5.8	INT Block Connections	5.14
Fig 5.9	RANG Block Connections	5.16
Fig 5.10	ST Parameter — Range & Limit Block	5.17
Fig 5.11	CONS Block Connections	5.19
Fig 5.12	ST Parameter — CONS Block	5.20
Fig 5.13	SAMP Block Connections	5.21
Fig 5.14	Connections for Gate Blocks (2-inputs)	5.23
Fig 5.15	AND4 & OR4 Block Connections	5.24
Fig 5.16	NOT Block Connections	5.24
Fig 5.17	LTCH Block Connections	5.25
Fig 5.18	GT/LT Block Connections	5.27
Fig 5.19	ST Parameters — GT/LT Blocks	5.28
Fig 5.20	GT Block — Application of Hysteresis	5.29
Fig 5.21	LT Block — Application of Hysteresis	5.29
Fig 5.22	EU Block Connections	5.30
Fig 5.23	ST Parameters — EU Block	5.31
Fig 5.24	EU Block — Application of Equal Band & Hysteresis	5.32
Fig 5.25	Selector Block Connections (2-input type)	5.33
Fig 5.26	MSL3 Block Connections	5.35
Fig 5.27	ST Parameters — MSL3 Block	5.36
Fig 5.28	SLCT Block Connections	5.37
Fig 5.29	Rate Block Schematic	5.39
Fig 5.30	RATE Block Connections	5.39
Fig 5.31	ST Parameter — Rate Block	5.41
Fig 5.32	Ramp Block Schematic	5.43
Fig 5.33	RAMP Block Connections	5.43
Fig 5.34	ST Parameter — Ramp Block	5.45
Fig 5.35	TIME Block Connections	5.47
Fig 5.36	ST Parameter — Timer Block	5.49
Fig 5.37	PGNT Block Connections	5.50
Fig 5.38	ST Parameter — Pulse Generator Block	5.52
Fig 5.39	Reset During MM	5.53
Fig 5.40	Reset After MM During ON Cycle	5.53
Fig 5.41	Reset During MS	5.53

	<i>page</i>
Fig 5.42 PGNT Block Connections	5.55
Fig 5.43 ST Parameter — Pulse Count Block	5.57
Fig 5.44 PEAK Block Connections	5.59
Fig 5.45 ST Parameter — Peak Detect (Max/Min) Block	5.61
Fig 5.46 Pseudo Analogue Input Block Schematic	5.63
Fig 5.47 Pseudo Analogue Input Block Connections	5.63
Fig 5.49 IN Parameter — Pseudo Analogue Input Block	5.65
Fig 5.50 Pseudo Analogue Output Block Schematic	5.68
Fig 5.51 Pseudo Analogue Output Block Connections	5.68
Fig 5.52 Pseudo Digital Input Block Schematic	5.71
Fig 5.53 Pseudo Digital Input Block Connections	5.71
Fig 5.54 IN Parameter — Pseudo Digital Input Block	5.73
Fig 5.55 DS Parameter — Pseudo Digital Input Block	5.74
Fig 5.56 Pseudo Digital Output Block Schematic	5.75
Fig 5.57 Pseudo Digital Output Block Connections	5.75
Fig 5.58 DS Parameter — Pseudo Digital Output Block	5.77
Fig 6.1 SW Parameter — Command Mode	6.3
Fig 6.2 PB Parameter — Command Mode	6.4
Fig 7.1 Control Loop Operating Modes	7.2
Fig 7.2 Example of Auto/Man. Control Loop	7.7
Fig 7.3 Response to Step Setpoint Change— Without Integral Balance	7.12
Fig 7.4 Response to Step Setpoint Change— With Integral Balance	7.12
Fig 7.5 Adaptive Gain Responses— Without Integral Balance	7.14
Fig 7.6 Adaptive Gain Responses— With Integral Balance	7.14
Fig 7.7 Effect of Inter al Desaturation (Integral Action)	7.15
Fig 7.8 Application of Integral Desaturation (Schematic)	7.16
Fig 7.9 Application With Integral Desaturation (PID Action)	7.17
Fig 7.10 Application Without Integral Desaturation (PID Action)	7.17
Fig 7.11 Implementation of Integral Balance & Integral Desaturation	7.19
Fig 8.1 Multi-Drop Supervisory Systems	8.1
Fig 8.2 Motherboard Switch Functions	8.3
Fig 8.3 Instrument Number (INO) Bits	8.7
Fig 10.1 Motherboard Switch Functions	10.7
Fig 11.1 Intelligent Loop Processor Hardware Block Schematic	11.2
Fig 11.2 6370/80 Series I/O & Zero Volts Block Schematic	11.15

LIST OF TABLES

	<i>page</i>	
Table 1.1	6370/80 Function Blocks & Features	1.2
Table 4.1	Fixed Blocks	4.2
Table 4.2	Data Format Symbols	4.6
Table 4.3	ANIN Field Input Pin Numbers	4.8
Table 4.4	ANIN Outgoing Connections	4.8
Table 4.5	ANIN Block Parameters	4.9
Table 4.6	ANOP Incoming Connections	4.16
Table 4.7	ANOP Outgoing Connections	4.16
Table 4.8	ANOP Field Output Pin Numbers	4.16
Table 4.9	ANOP Block Parameters	4.17
Table 4.10	DGIN Field Input Pin Numbers	4.22
Table 4.11	DGIN Outgoing Connections	4.23
Table 4.12	DGIN Block Parameters	4.23
Table 4.13	DGOP Incoming Connections	4.27
Table 4.14	DGOP Outgoing Connections	4.27
Table 4.15	DGOP Field Output Pin Numbers	4.28
Table 4.16	DGOP Block Parameters	4.28
Table 4.17	MANS Incoming Connections	4.33
Table 4.18	MANS Outgoing Connections	4.33
Table 4.19	MANS Block Parameters	4.34
Table 4.20	MP Input — Front Panel Pushbutton Responses	4.36
Table 4.21	XPID Incoming Connections	4.40
Table 4.22	XPID Outgoing Connections	4.42
Table 4.23	XPID Block Parameters	4.42
Table 4.24	3T Parameter Bits 1 & 0 Power-up Action	4.50
Table 4.25	Selection of Loop Operating Mode via Serial Data Links	4.57
Table 4.26	XCON Incoming Connections	4.61
Table 4.27	XCON Outgoing Connections	4.62
Table 4.28	XCON Block Parameters	4.63
Table 4.29	RPID Incoming Connections	4.70
Table 4.30	RPID Outgoing Connections	4.72
Table 4.31	RPID Block Parameters	4.73
Table 4.32	Selection of Loop Operating Mode via Serial Data Links	4.76
Table 4.33	RCON Incoming Connections	4.81

	<i>page</i>
Table 4.34 RCON Outgoing Connections	4.82
Table 4.35 RCON Block Parameters	4.83
Table 4.36 GENP Outgoing Connections	4.86
Table 4.37 GENP Incoming Connections	4.87
Table 4.38 GENP Block Parameters	4.87
Table 4.39 LLAG Incoming Connections	4.95
Table 4.40 LLAG Outgoing Connections	4.95
Table 4.41 LLAG Block Parameters	4.96
Table 4.42 DTIM Incoming Connections	4.100
Table 4.43 DTIM Outgoing Connections	4.100
Table 4.44 DTIM Block Parameters	4.101
Table 4.45 TOTL Incoming Connections	4.105
Table 4.46 TOTL Outgoing Connections	4.105
Table 4.47 TOTL Block Parameters	4.105
Table 4.48 DISP Incoming Connections	4.110
Table 4.49 DISP Outgoing Connections	4.111
Table 4.50 DISP Block Parameters	4.111
Table 4.51 ALRM Incoming Connections	4.117
Table 4.52 ALRM Outgoing Connections	4.117
Table 4.53 ALRM Block Parameters	4.118
Table 4.54 CHAR Incoming Connections	4.122
Table 4.55 CHAR Outgoing Connections	4.122
Table 4.56 CHAR Block Parameters	4.123
Table 5.1 Assigned Blocks Library	5.2
Table 5.2 Arithmetic Blocks Parameters	5.6
Table 5.3 Trigonometric Blocks Parameters	5.9
Table 5.4 Operator Blocks Parameters	5.12
Table 5.5 EXPN Block Parameters	5.13
Table 5.6 INIT Incoming Connections	5.14
Table 5.7 INIT Outgoing Connections	5.14
Table 5.8 INIT Block Parameters	5.15
Table 5.9 RANG Outgoing Connections	5.16
Table 5.10 RANG Block Parameters	5.16
Table 5.11 RANG Incoming Connections	5.17
Table 5.12 CONS Block Parameters	5.19
Table 5.13 SAMP Block Parameters	5.21
Table 5.14 Logic Blocks Parameters	5.26
Table 5.15 GT and LT Blocks Parameters	5.28
Table 5.16 EU Blocks Parameters	5.31

	<i>page</i>
Table 5.17	Selector Block Parameters 5.34
Table 5.18	MSL3 Block Parameters 5.36
Table 5.19	SLCT Block Parameters 5.38
Table 5.20	RATE Incoming Connections 5.40
Table 5.21	RATE Outgoing Connections 5.40
Table 5.22	RATE Block Parameters 5.40
Table 5.23	RAMP Incoming Connections 5.44
Table 5.24	RAMP Outgoing Connections 5.44
Table 5.25	RAMP Block Parameters 5.44
Table 5.26	TIME Incoming Connections 5.47
Table 5.27	TIME Outgoing Connections 5.48
Table 5.28	TIME Block Parameters 5.48
Table 5.29	PGNT Incoming Connections 5.50
Table 5.30	PGNT Outgoing Connections 5.51
Table 5.31	PGNT Block Parameters 5.51
Table 5.32	PGNT Output Possibilities 5.54
Table 5.33	PCNT Incoming Connections 5.55
Table 5.34	PCNT Outgoing Connections 5.56
Table 5.35	PCNT Block Parameters 5.56
Table 5.36	PEAK Incoming Connections 5.59
Table 5.37	PEAK Outgoing Connections 5.60
Table 5.38	PEAK Block Parameters 5.60
Table 5.39	AICB Incoming Connections 5.63
Table 5.40	AICB Outgoing Connections 5.64
Table 5.41	AICB Block Parameters 5.64
Table 5.42	AOCB Outgoing Connections 5.69
Table 5.43	AOCB Block Parameters 5.69
Table 5.44	DICB Incoming Connections 5.72
Table 5.45	DICB Outgoing Connections 5.72
Table 5.46	DICB Block Parameters 5.72
Table 5.47	DOCB Outgoing Connections 5.75
Table 5.48	DOCB Block Parameters 5.76
Table 6.1	Command Mode Parameters 6.1
Table 6.2	II Parameter & Instrument Functionality 6.2
Table 7.1	Control Modes & Priorities 7.1
Table 7.2	Control Mode Enable Conditions & Operating Characteristics 7.4
Table 7.3	Mode Information from 6370/80 Series Control Blocks 7.6

	<i>page</i>
Table 8.1 Instrument Parameter Subset Addresses	8.8
Table 8.2 Parameter Numbers for 6356/66 (n=1, 2)	8.10
Table 8.3 PNOs for 6372/82 Loop 1	8.11
Table 8.4 PNOs for 6372/82 Loop 2	8.12
Table 8.5 Parameter Numbers for 6370/80	8.13
Table 8.6 PNOs for '6432 Analogue I/P Boards'	8.14
Table 8.7 PNOs for '6432 Analogue O/P Boards'	8.15
Table 8.8 PNOs for '6432 Digital I/P Boards'	8.16
Table 8.9 PNOs for '6432 Digital O/P Boards'	8.17
Table 9.1 6370/80 Series Task Scheduling	9.1
Table 10.1 Hand Held Terminal Error Conditions	10.1
Table 10.2 Instrument Failure Error Conditions	10.3

Chapter 1

GENERAL DESCRIPTION

Introduction to the Series

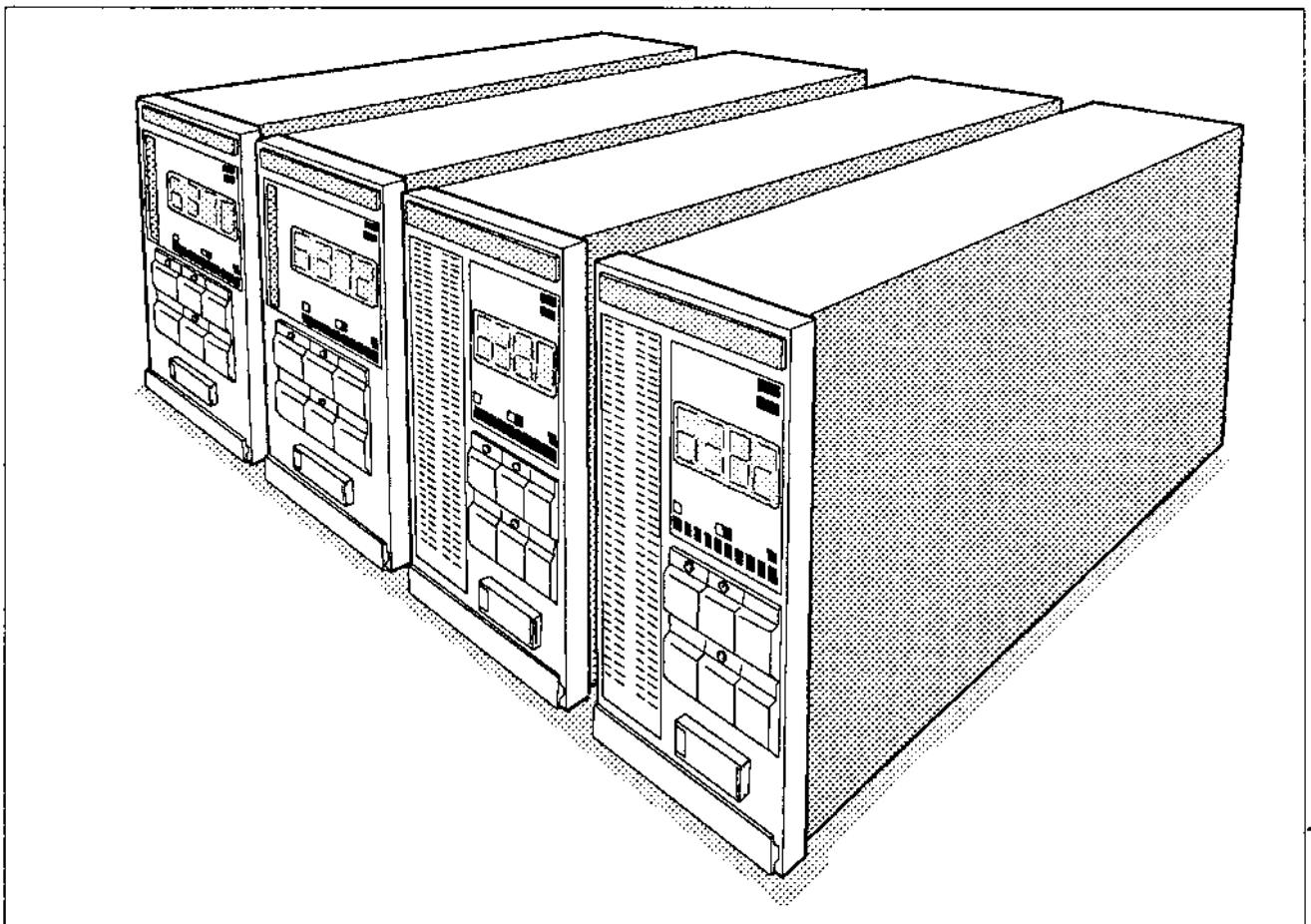

Figure 1.1 *6370/80 Series Intelligent Loop Processors*

The TCS 6370/80 Series Intelligent Loop Processors comprise four units capable of handling all aspects of single and dual loop process control. The range lets you choose between basic single-loop (6370/80) and more powerful dual-loop (6372/82) instruments, and between deviation bargraph (6370/2) and dual bargraph (6380/2) front panels (see Chapter 2).

A wide selection of facilities is offered, allowing 3-term PID, ratio, cascade, feedforward, lead-lag, and a broad range of control functions to be configured using the 8263 Hand-Held Terminal (see Chapter 3), or via the TCS IBM PC compatible driver. Configurations are also downloadable from a supervisory system (*not implemented at Issue 3.2 software*).

Block Structure. You can store up to two control strategies in the instrument from standard applications and recall them on demand. Alternatively, highly complex strategies can be devised and stored using the powerful block structuring facility. Blocks are interconnected, and then scheduled by the Intelligent Loop Processor's own internal expert system to achieve optimum loop processing.

Table 1.1 shows the numbers and availability of block and function types for each of the Intelligent Loop Processors.

BLOCK or FUNCTION	6370/80	6372/82
ANALOGUE INPUT	4	8
ANALOGUE OUTPUT	4	4
DIGITAL INPUT (8-CHANNEL)	1	1
DIGITAL OUTPUT (8-CHANNEL)	1	1
CONTROL	1	2
MANUAL STATION	1	2
DEADTIME	-	2
LEAD/LAG	-	2
TOTALISATION	-	2
ALARM	1	2
CHARACTERISER	-	2
DISPLAY	-	1
GENERAL PURPOSE	1	1
ASSIGNED	12	80
LIBRARY FUNCTIONS	12	48
STORED PROGRAMS	2	2
TIME SCHEDULED USER TASKS (LOOPS)	1	2
BACKGROUND USER TASKS	-	1

Table 1.1 6370/80 Series Function Blocks & Features

Fixed blocks (see Chapter 4) include I/O, and control functions. Assigned blocks (Chapter 5), chosen from a library resident in the instrument, perform the mathematical, logical, and comms operations needed in a control strategy.

GENERAL DESCRIPTION

Emulation Capability. By writing an appropriate value to an Intelligent Loop Processor's *identity parameter* (II) you can make it emulate functionally a TCS 6350 or 6360 Process Controller (depending on model). It is also possible, via the II parameter, to configure the instrument to function normally but appear on the RS422 communications bus as a 6356 or 6366 instrument (again, depending on model). Chapter 8 gives further details.

Communications. An inbuilt communications interface (implemented via the control and 'pseudo I/O' blocks — not 6370/80) makes computer supervision of the 6370/80 Series particularly easy (see Chapter 8). The interface allows an intelligent device to monitor and/or update any of the parameters in a network of System 6000 instruments. This is done via an RS422 serial bus (using a standard ANSI protocol) available on the module rear connector pins. The RS232 serial port accessed via the front panel socket is used for the hand-held programming terminal.

Diagnostics & Reliability. Solid state single-board technology at the heart of the 6370/80 family gives high reliability, and self-diagnostic procedures within each instrument simplify fault-finding (see Chapter 10). Block inputs and outputs can also be used to create custom diagnostics that pin-point errors and trigger any necessary countermeasures.

Packaging. 6370/80 Series Intelligent Loop Processors are fully compatible, electrically and mechanically, with the TCS System 6000 range of Intelligent Instrumentation and the Network 6000 range of control/supervisory equipment.

As systems components, they plug directly into the 7950 Universal Packaging System for rack- or panel-mounted plant installation (see page 1.6), and integrate with the full capabilities of the range. Intelligent Loop Processors are also available housed within a 72mm DIN-compatible sleeve (the 7930) for front-of-panel mounting, and the 'split architecture' approach of the 7800 system allows sideways mounting in shallow enclosures.

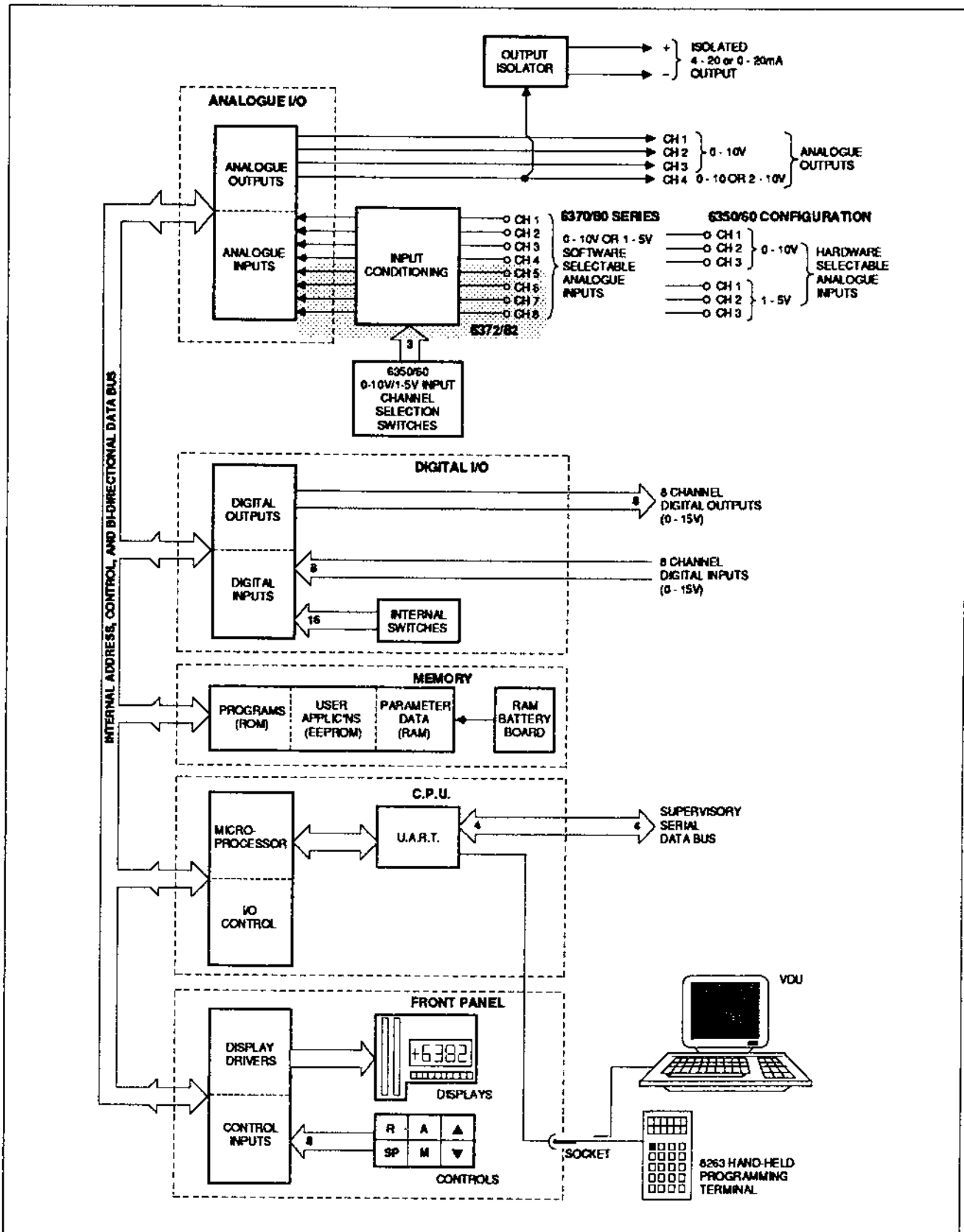

Figure 1.2 Intelligent Loop Processor Hardware Block Schematic

Hardware Organisation

Figure 1.2 shows a schematic block diagram of the instrument hardware organisation.

Each of the Intelligent Loop Processor functions, namely:

- Front Panel Displays & Operator Controls
- Central Processor Unit
- Memory
- Digital Input/Output
- Analogue Input/Output

is generally implemented in a distinct hardware functional block, but all (except the front panel) are integrated onto a single motherboard. Hardware blocks communicate with the Central Processor Unit (CPU) — which controls the overall operation of the instrument — via a bi-directional internal communications bus.

The CPU itself contains the Microprocessor, which is the intelligent 'heart' of the device. The microprocessor communicates with a Memory block which stores the necessary set of control programs and all control parameters.

The Front Panel contains all the indicators, displays, and push-buttons needed for an operator to monitor and interact with a process control loop. Loop mode may be switched between Manual and Automatic (with local or remotely supplied setpoints), and changes made to the operating conditions within these control modes.

An 8263 hand-held programming terminal plugs into the front-panel socket and can be used to set up the control loop characteristics initially, or to monitor/change any of the control parameters later. Access to all the loop parameters for monitoring or updating is also possible via an alternative connector on the back panel. This is intended for supervisory computer use.

The Digital Outputs are all fully user-configurable (unless the instrument is emulating a 6350/60) to provide alarm and status information about the instrument via eight logic signals. The Digital Inputs are also fully user-configurable (not 6350/60) and can be used to control the operation of the instrument via external logic signals, when it is interacting with other instruments in complex situations (such as cascade loops).

The configurable (not 6350/60) Analogue Inputs can be used to monitor the

plant process variable and receive external setpoints and trims. The Analogue Outputs can be configured (not 6350/60) to provide the necessary control signals to the actuator drivers and can also re-transmit the process variable and setpoint or error.

Analogue outputs are available in two forms: a 0 - 10V non-isolated signal (all four channels), and a 4 - 20mA (2 - 10V) or 0 - 20mA (0 - 10V) isolated signal (channel 4 only).

Mechanical Structure

Figure 1.3 shows the internal structure of the Intelligent Loop Processors (Motherboard, Assy. AH079040, with dual bargraph front panel illustrated). Details of accessing the motherboard, board issue variations, and switchbank functions, are given in the *User Guide*, Chapter 1.

The front panel daughterboard is connected to the motherboard via a 15-way connector, and secured with mounting posts, support bar, and strut.

The motherboard carries all the other electronics including the fuses, power supply circuitry and the plug-in battery board. The rear end of the motherboard incorporates polarising slots to mate with polarising pegs fitted to the 48-way systems connector housed within the 7950 Universal Packaging system.

7950 Universal Packaging System. The preferred way of mounting Intelligent Loop Processors is to use the 7950 Universal Packaging System. This offers a choice of 19-inch rack or panel mounting and is available in four standard widths for housing 1, 2, 3 or 6 units. The instruments plug into individual Termination Assemblies fitted at the rear of the 7950 rack frame. Each termination assembly consists of a 48-way backplane socket wired to a set of three 16-way screw terminal blocks for customer connections.

With the TRU option the rear panel screw terminals are left uncovered; cable trunking is provided at the bottom and a marker rail at the top of the rack frame. When CGP is specified the screw terminals are protected by a full-width hinge-down cover incorporating fixed cable entry glands and strain relief clamps. Cable trunking is also provided above the terminal blocks and individual instrument power supplies (type 8750) may be fitted inside the hinge-down cover.

GENERAL DESCRIPTION

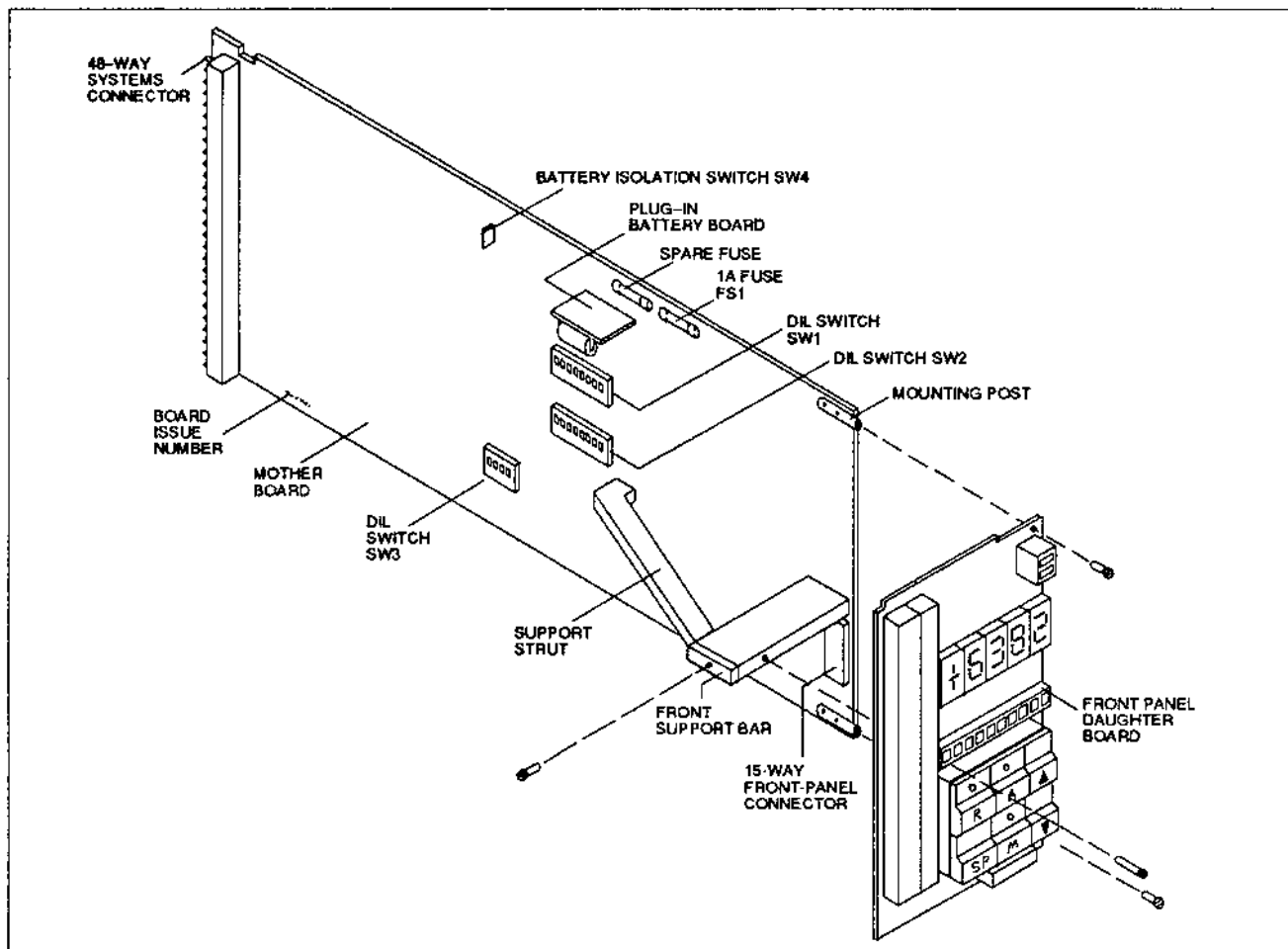

Figure 1.3 6370/80 Series Internal Structure

To mount the instrument in a 7950 rack the appropriate Rear Termination Assembly should be specified: e.g. for a 6382 instrument specify TA6382. When burden resistors or power supply steering diodes are required, specify the TA 63XXB or TA 63XXD options, respectively. For further information refer to the TA637X/8X sheet available from TCS.

Functional Descriptions of Boards & Circuit Blocks

Front-Panel Daughter Board. (6370/2: Assy. AH079 037; 6380/2: AH075225). This board holds all the indicator and display components together with the operator control push-buttons. Please refer to Chapter 2, *6370/80 Series Front Panels*, for details. This board also contains all the drive electronics associated with these displays and push-buttons and carries the 7-pin socket for the 8263 hand-held programming terminal.

Central Processor Circuit Block. The CPU circuit block contains the 16-bit microprocessor together with the associated support logic required for interrupt handling and for providing the necessary I/O decoding logic. A Universal Asynchronous Receiver Transmitter (UART) circuit and associated drivers are used to communicate with either the 8263 Hand-held terminal via the front panel socket, or with a supervisory system via the rear connector serial data bus.

The CPU block also contains a watchdog timer circuit which monitors the microprocessor I/O functions. If a failure is detected all the analogue outputs are 'frozen' and all front panel displays are cleared except the bottom bar on each of the bargraph displays (or the central LED of the deviation bargraph in 6370/2 instruments).

Memory Circuit Block. The memory circuit block is divided into three separate memory areas:

■ **ROM Area**

The ROM area contains the Intelligent Loop Processor operating software.

■ **RAM Area**

The non-volatile RAM area contains the executing program and the instrument database, consisting of the control loop parameters and other variables. RAM write-protect can be switched on.

■ **EEPROM Area**

The write-protectable EEPROM memory can be used to store both the instrument database and user applications programs for additional security (up to two databases may be stored). Programs are always executed from RAM to allow on-line debugging and subsequent editing. Once the program has been checked out fully you can transfer data from the RAM area into the Electrically Erasable PROM (EEPROM). Data can also be copied from the EEPROM area back into the RAM to permit further editing and debugging cycles to be carried out. Normally on power-up the battery backed RAM runs a program. If the battery fails whilst the power is off, the RAM program is lost and on subsequent power-up a program halt error occurs with the Manual Station output locked to analogue output B4 (loop 1) or B3 (loop 2).

GENERAL DESCRIPTION

The RAM chips are made non-volatile by means of a standby battery (long-life lithium primary cell) supply circuit which powers them when the main supply has failed or undergoes a transient failure. The features of the supply circuit are:

- **Lithium Battery.** The battery is not soldered directly to the motherboard but is fitted to a separate plug-in battery board (Assy: AH076044) which connects to the motherboard via two 2-way plugs and sockets and is held in place by a board-restraining bracket.
- **Battery Standby.** When the battery board is disconnected for battery replacement, standby current to the CMOS RAM is supplied by a high value 'Supercap' fitted to the motherboard. This capacitor will maintain the RAM in its non-volatile state for a minimum period of 20 minutes while the battery board is being replaced.
- **Battery Isolation Switch.** The battery supply can be isolated from the RAM by means of switch SW4). This might be done to conserve battery life when the instrument is to be left unpowered for any great length of time. This switch is pushed in to connect the battery and pulled out to isolate the battery from the RAM.
- **Battery Replacement.**

CAUTION. *The battery can be short-circuited and corroded by skin moisture, so handle only by the board edges. On no account finger the battery terminals.*

To remove the battery board, unscrew the nylon retaining screw and withdraw the board carefully, keeping it perpendicular to the motherboard to avoid stressing the two connector sockets. Replacement is the reverse procedure.

Digital Input/Output Circuit Block. This block provides for 8 external 0/15V user-configurable logic level inputs via the rear connector. 16 internal switches are also provided to set up digital inputs to characterise the instrument with certain control mode parameters. In addition the block provides 8 external 0/15V user-configurable logic level outputs.

Analogue Input/Output Circuit Block. This block contains circuitry to provide the 4 non-isolated 0 - 10V output channels, each of which incorporates a medium-term sample-and-hold output stage. Channel 4 is also available as an isolated output. The block accepts 8 non-isolated 0 - 10V input channels

which are multiplexed onto the single analogue input bus before being converted into digital form for the CPU. In addition, circuitry is provided to allow the CPU to measure the battery voltage under dynamic loading conditions.

The block contains circuitry to detect an open-circuit (all signals), and an out-of-range signal (1 - 5V signals: input less than 0.6V; 0 - 10V signals: input less than -0.75V). The block also contains an isolated transmitter power supply which is available via the rear connector for powering a remote 4 - 20mA transmitter.

(Please refer to Chapter 11, *Specifications*.)

Output Isolator Circuit Block. This block has circuitry to make the fourth channel available as a 4 - 20mA isolated output signal available on separate rear connector pins.

Power Supply Circuit Block. This block has a switched mode power supply circuit that generates the +5V, +12V, -5V, and -12V supplies. The supply is basically a 25W current mode, 100kHz fixed frequency circuit employing variable duty cycle control. The inner control loop has current feedback for fast response to transients, while the outer control loop has voltage feedback which is used to control the 5V supply. The main supply transformer has five secondary windings whose voltages are all 'slaved' to the 5V rail. These windings generate the following supplies:

- A centre-tapped winding generates +15V and -15V to supply the analogue circuitry.
- The main winding generates the +5V supply for the CPU, memory, front panel and logic circuitry. This winding is zener-protected and causes the control circuit to 'trip and try again' if this voltage is exceeded.
- A 35V (nominal) winding is used for the transmitter power supply circuit.
- A 27V (nominal) winding is used to power the 4 - 20mA output isolator circuit.
- The last winding generates two +15V supplies, one of which is used to power the internal logic. The other supply is for the eight digital outputs but may be overridden by a higher external voltage applied to pin 7 of the instrument.

GENERAL DESCRIPTION

The power supply circuitry goes into foldback current limit and 'trips and tries again' if the power level exceeds 25W. Logic is also included to detect power-on and power failure conditions and alert the CPU accordingly.

Fuse. The power supply is provided with a 1A main fuse and a spare which are fitted along the top edge of the motherboard. The fuse-holders accept either 20mm or 1.25 inch cartridges.



Chapter 2

6370/80 SERIES FRONT PANELS

There are four variants of front panel in the Intelligent Loop Processor series of instruments, shown in Figures 2.1 to 2.4. 6370 series instruments have *deviation* bargraph front panels, and 6380 series instruments have *dual* bargraph front panels. The single-loop (6370 and 6380) models have *track* and *hold* LED indicators, whereas in dual-loop models (6372 and 6382) the two LEDs indicate *loop 1* and *loop 2* instead.

In the figures, the circled numbers refer to the paragraphs giving details of each front panel feature.

1 Power-On Indicator(s)

6370 Series. The green LED in the centre of the two deviation bargraphs glows when power is on. It also indicates zero deviation.

6380 Series. The bottom two bars of the PV and SP bargraphs glow when power is on. They also indicate zero readings.

For both series, in the event of a watchdog failure the power-on LED(s) stay(s) lit while all other displays are blanked. This makes it possible to distinguish between a watchdog failure and a power supply failure (when *all* displays go out).

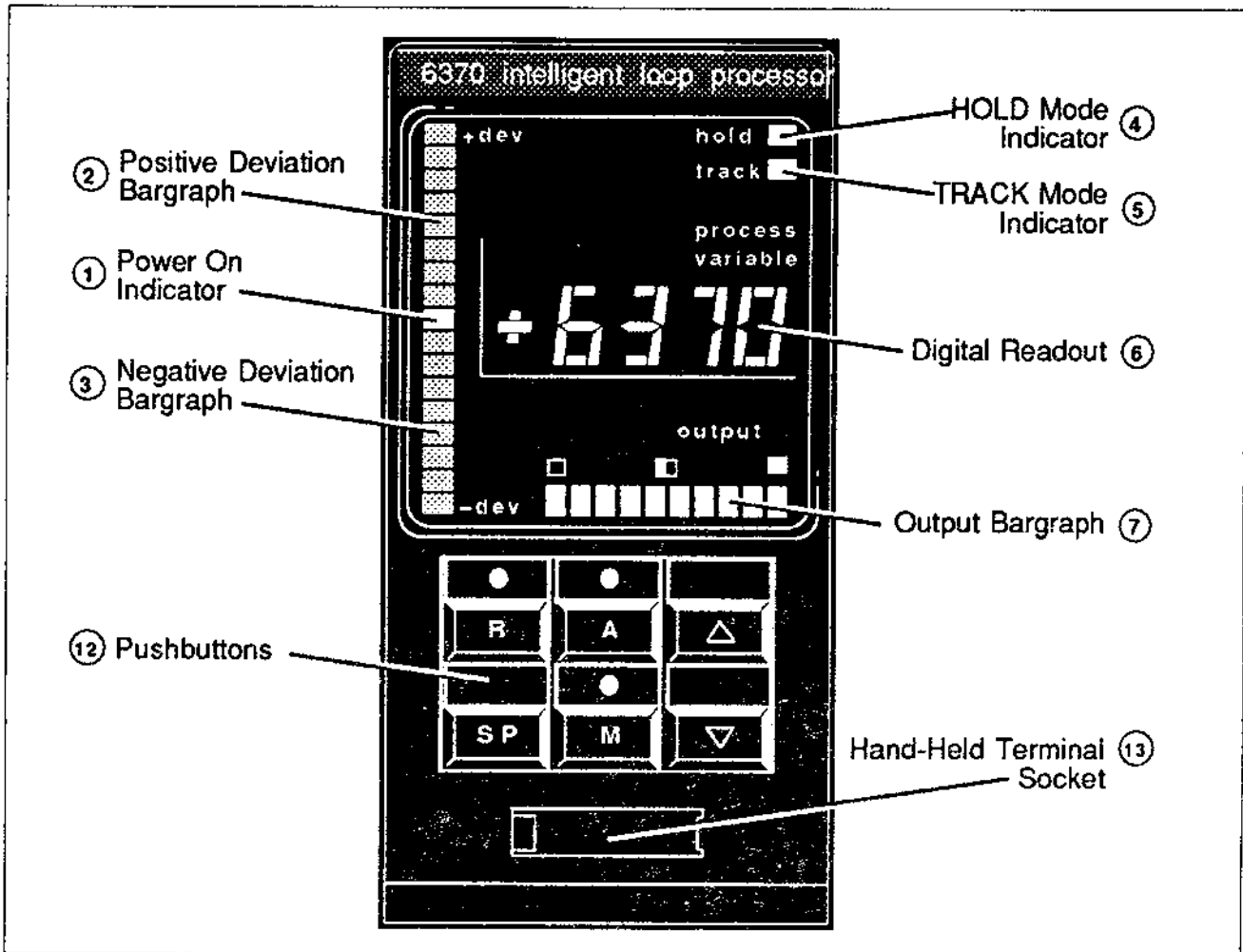
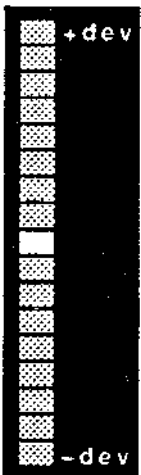

Figure 2.1 6370 Front Panel

2 & 3 Positive & Negative Deviation Bargraphs



Two red 8-segment LED bargraphs represent the positive and negative deviations (errors) between the process variable PV and the resultant setpoint SP. Error $ER = PV - SP$. The central (green) LED doubles as the bargraph zero and as a power-on indicator. The display segments light up progressively in 1% steps at the following deviation values: 0.5, 1.5, 2.5, 3.5, 4.5, 5.5, 6.5, and 7.5%.

When a high or low deviation or absolute alarm occurs, the positive or negative deviation bargraph, respectively, flashes continuously.

In *display mode* (6372 instrument) the deviation bargraph is assignable to any variable via the DISP block (see Chapter 4).

FRONT PANELS

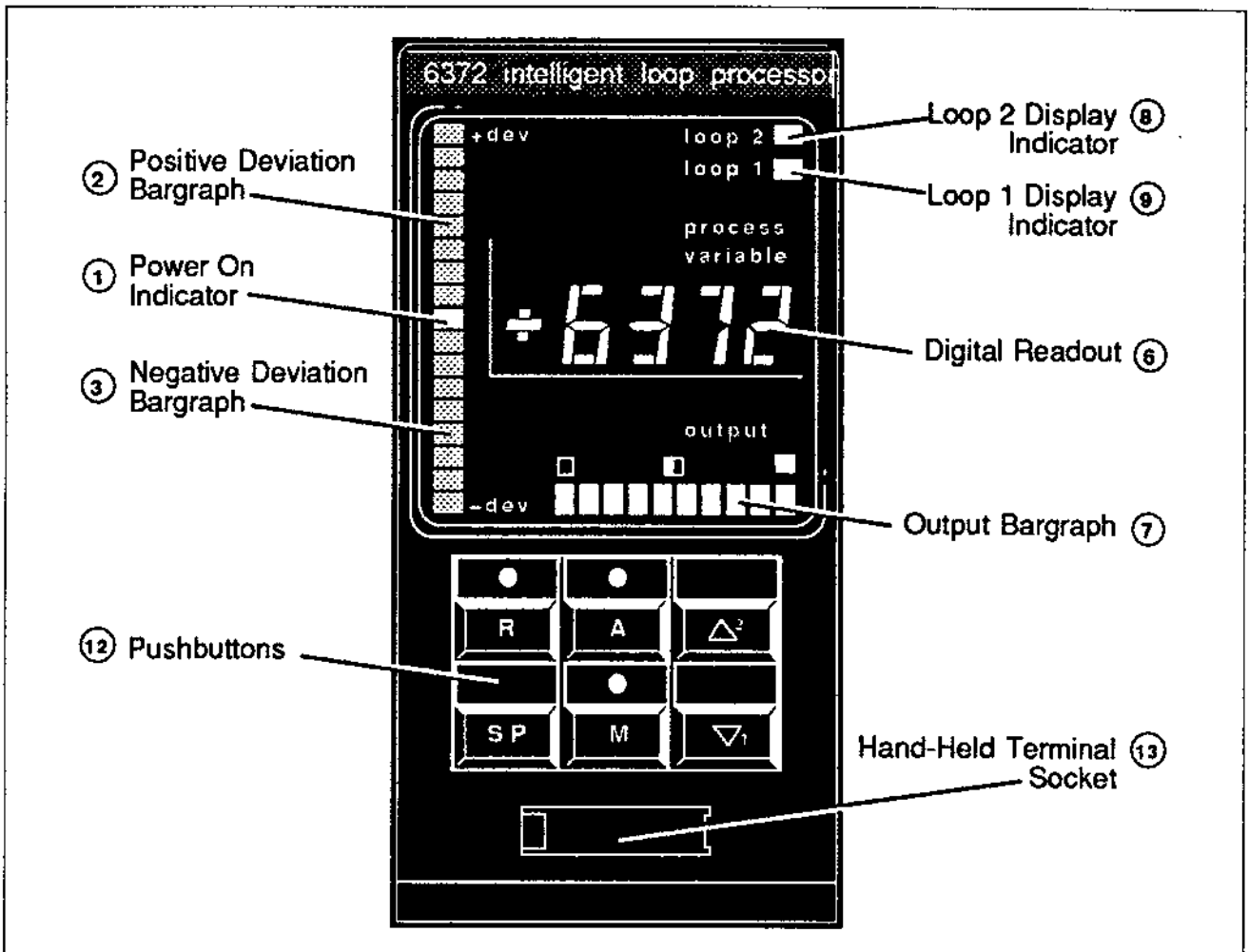

Figure 2.2 6372 Front Panel

4 & 5 HOLD & TRACK Mode Indicators



Two yellow LEDs indicate HOLD or TRACK mode controller operation. HOLD mode overrides all other operating modes and holds the controller output at a fixed value. TRACK mode overrides all other operating modes except HOLD. In TRACK mode the controller output is controlled by an analogue input signal, or set manually.

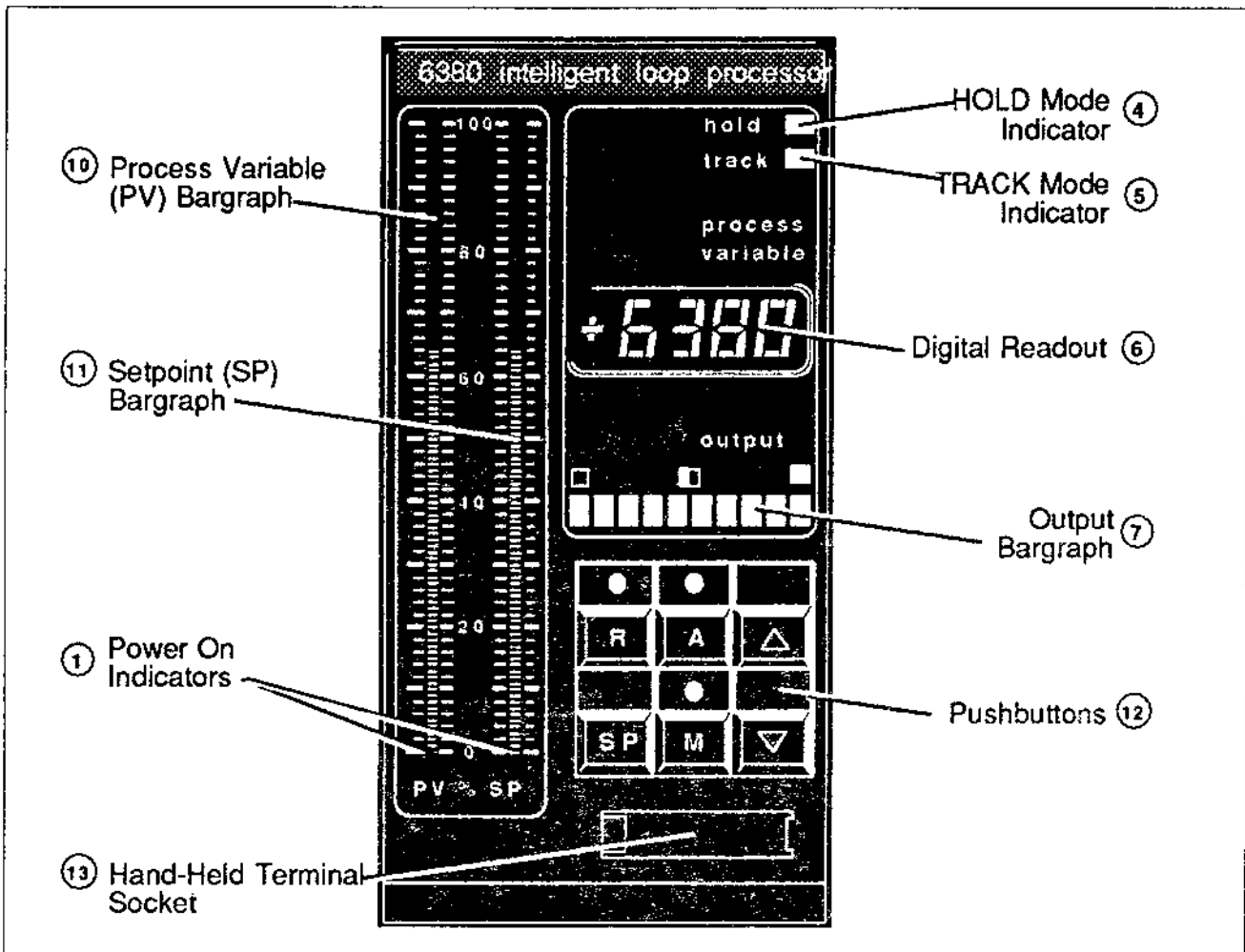

Figure 2.3 6380 Front Panel

6 Digital Readout



4-digit orange LED display with sign and decimal point.

- With no pushbuttons pressed, the digital readout displays the *process variable* (PV) value in engineering units.
- While the SP button is pressed the *local setpoint* (SL) is displayed in engineering units, unless the controller is in RATIO mode when the *ratio setting* (RS) is displayed instead.
- When either the M, A, or R buttons are pressed, what is displayed depends on whether or not the Manual Station's MP input is connected to. Please refer to Table 4.20 on page 4.43

FRONT PANELS

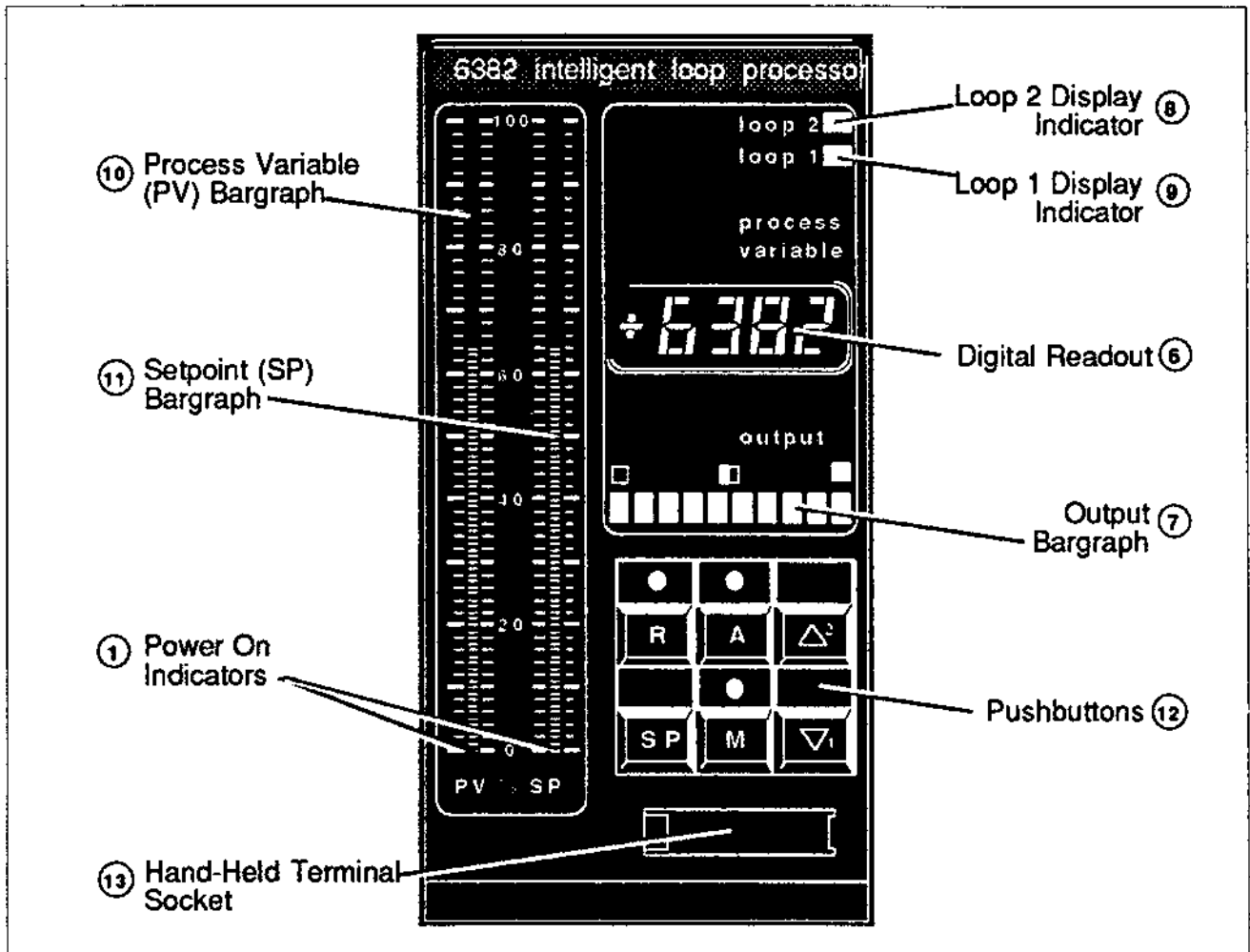

Figure 2.4 6382 Front Panel

The random access memory (RAM) is supported by a long-life battery during power interruptions. If the RAM battery voltage falls to an unsafe level, the unused decimal points on the digital readout flash on and off continuously.

The whole digital readout flashing on and off continuously means that the displayed loop program has stopped running.

In *display mode* (6372/82 instruments) the digital readout is assignable to any variable via the DISP block (Chapter 4).

7 Output Bargraph



A yellow 10-segment LED bargraph indicates the *controller output* (MO) value (or the *measured position* MP, if connected) in percent. The display segments light up progressively in 10% steps at the following output values: 5, 15, 25, 35, 45, 55, 65, 75, 85, and 95%. If the M, A, or R buttons are pressed the bargraph displays the *output demand* (OP) of the loop's MANS block.

In *display mode* (6372 instrument) the bargraph is assignable to any variable via the DISP block (Chapter 4).

8 & 9 Loop 2 & Loop 1 Display Indicators



Two yellow LEDs indicate which of the two control loops is being displayed on the front panel. Both LEDs lit means that the instrument is in *display mode*, when the mode pushbuttons are disabled and the displays are driven by the DISP block (see Chapter 4).

When the displayed loop is in TRACK or HOLD mode, 2-loop instruments flash the relevant loop LED continuously on and off. (Single-loop instruments have dedicated mode LEDs.)

10 Process Variable (PV) Bargraph



A 101-segment bargraph represents the *process variable* PV in percentage units after linearisation and filtering.

If a deviation or absolute alarm limit is exceeded the bargraph flashes continuously on and off.

In *display mode* (6372/82 instruments) the PV bargraph is assignable to any variable via the DISP block (Chapter 4).

11 Setpoint (SP) Bargraph



A 101-segment bargraph represents the rate-limited *resultant setpoint* SP (i.e. local setpoint SL + setpoint bias SB), in percentage units.

In *display mode* (6372/82 instruments) the SP bargraph is assignable to any variable via the DISP block (Chapter 4).

12 Pushbuttons

Altering Normal Pushbutton Functions

Some or all of the normal pushbutton functions described below can be overridden or altered in several ways:

- **Pushbutton Masking.** You can disable any or all of the three mode select buttons — (M)anual, (A)uto, and (R)emote/Ratio — and also the setpoint and controller output adjustment button combinations, via the SM parameter of a control block. Please refer to Chapter 4 for details.
- **Display Mode.** When *display mode* is selected (6372/82 only) all buttons are disabled (though presses are detected) except for 'raise' (Δ) and 'lower' (∇), which can be used to exit display mode. See Chapter 4, DISP block.
- **Digital Inputs to a Control Strategy.** You can assign any or all of the six pushbuttons as digital inputs to a control strategy, via the GENP block. Pressing an assigned button, whatever loop is being displayed, may then trigger an event unrelated to its normal function. Refer to Chapter 4 for details.

Manual Mode Select



Selects MANUAL mode of controller operation, and incorporates a yellow LED which lights when MANUAL is active.

A continuously flashing LED means that the controller has been 'forced' into FORCED MANUAL mode.

Auto(matic) Mode Select



Selects AUTO mode of controller operation, and incorporates a green LED which lights when AUTO is active.

A continuously flashing LED means that the controller has been 'forced' into AUTO FALLBACK mode by a failed attempt to select REMOTE/RATIO.

Remote/Ratio Mode Select

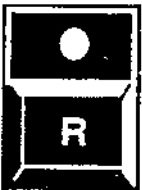

Selects REMOTE mode or RATIO mode of controller operation, and incorporates a green LED which lights when either of these modes is active.

The controller can operate in REMOTE or RATIO only if these modes have been enabled. If not, the control action is 'forced' into AUTO FALLBACK mode instead.

Setpoint Display



Pressing this button on its own causes the digital readout to display the *local setpoint* (SL, in engineering units), unless the controller is in RATIO mode when the *ratio setting* (RS) is displayed instead.

Setpoint Adjustment

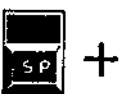

In AUTO mode, the *local setpoint* (SL) can be adjusted up or down by pressing the SP button and at the same time either the 'raise' or 'lower' pushbuttons, respectively. This applies also to MANUAL, TRACK and HOLD modes provided setpoint tracking is not enabled.



Controller Output Adjustment

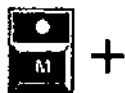

+

In MANUAL mode only, the *controller output* (MO via OP) can be adjusted up or down by pressing the M button and at the same time either the 'raise' or 'lower' pushbuttons, respectively.



Process Alarm Settings

6360 emulations only. You can view the settings of the process alarms on the PV and SP bargraphs, by using the 'raise' and 'lower' pushbuttons.



Press the 'raise' button to display the *high absolute alarm limit* (HA) on the PV bargraph, and the *high deviation alarm limit* (HD) on the SP bargraph, as single lit bars.



Press the 'lower' pushbutton to display the two low process alarm settings (LA and LD) on each bargraph.

(Refer to Chapter 6 for details on changing the configured identity of an Intelligent Loop Processor, via the II parameter.)

Displayed Loop & Display Mode Selection



Press the 'raise' button for at least 0.75 seconds to access and display *Loop 2* data on the front panel. (The delay is to minimise the risk of accidentally changing the loop whilst, for example, adjusting a setpoint.)



Press the 'lower' button for at least 0.75 seconds to access and display *Loop 1* data on the front panel.



+

Press the 'raise' and 'lower' buttons together for at least 0.75 seconds to access *Display Mode*.

13 Hand-Held Terminal Socket



This socket accepts the 8263 Hand-Held Terminal, or a computer/VDU terminal, for RS232 configuration of the instruments. (Alternatively, the rear-panel RS422 data link can be used with a supervisory computer.)

Chapter 3

THE 8263 HAND-HELD TERMINAL

This chapter describes the 8263 and defines all the key functions available for use with Intelligent Loop Processors. The 8263 can also be used to program certain other TCS instruments, but this is not covered here. Detailed electrical and mechanical specifications of the 8263 are in Chapter 11.

If you are new to the 8263 Hand-Held Terminal, probably the best way to get familiar with it is first to read Chapter 2 of the User Guide, *Using the 8263 Hand-Held Terminal*. Then try the *Hands-On Tutorial* in Chapter 3 of the Guide, to gain practise using it.

⚠ WARNING: Take great care when using the Hand-Held Terminal on an instrument connected to 'live' plant. It allows access to all parameters, and can halt user programs. To avoid this, make the instrument's PROGRAM area *read-only* (by setting switch 3 of motherboard switchbank 3 to OFF).

TERMINAL FEATURES

The 8263 Hand-Held Terminal (Figure 3.1) is a pocket-sized programming terminal that plugs into the front panel socket of an Intelligent Loop Processor. It draws 0.1W of power from the host instrument.

Using the 8263 you can communicate both ways with the instrument, accessing its database to read and/or enter data, install and interconnect function blocks. Most data is keyed in directly in engineering units. Blocks and parameters are accessed by simple two-character mnemonics.

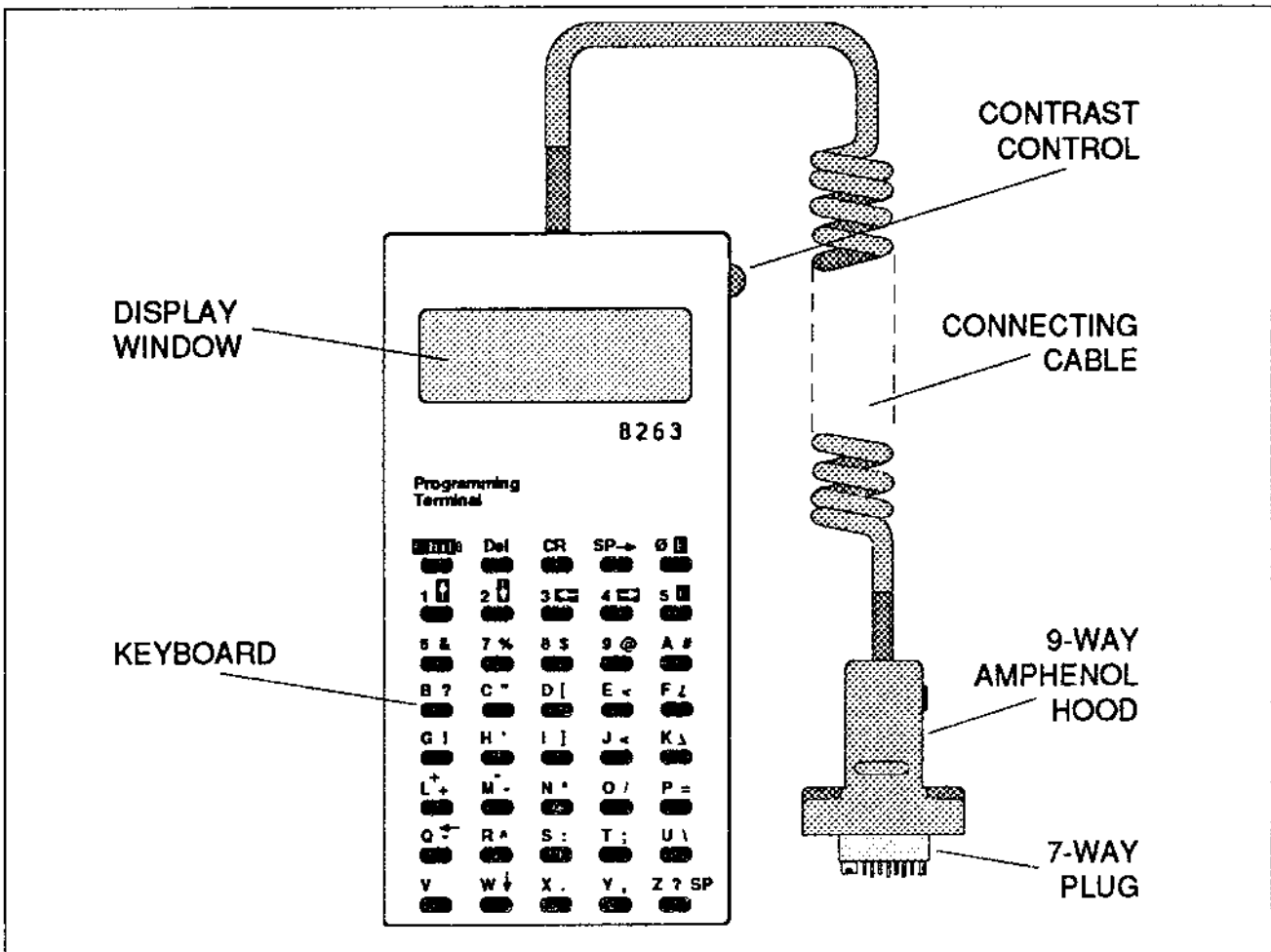

Figure 3.1 The 8263 Hand-Held Terminal

Terminal Setup

The 8263 is supplied factory-set for correct operation with all Intelligent Loop Processors. (No user-adjustable components are accessible via the small removable door in the back of the unit.)

Cable & Plug

The 8263 is supplied fitted with a telephone-style helical connection cable terminating in a 7-way plug, as shown in Figure 3.1. Pin designations, pin functions, and cable wiring details are shown in Figure 3.2. The 8263 plug connects with the mating 7-way socket located behind a small door at the foot of the instrument fascia.

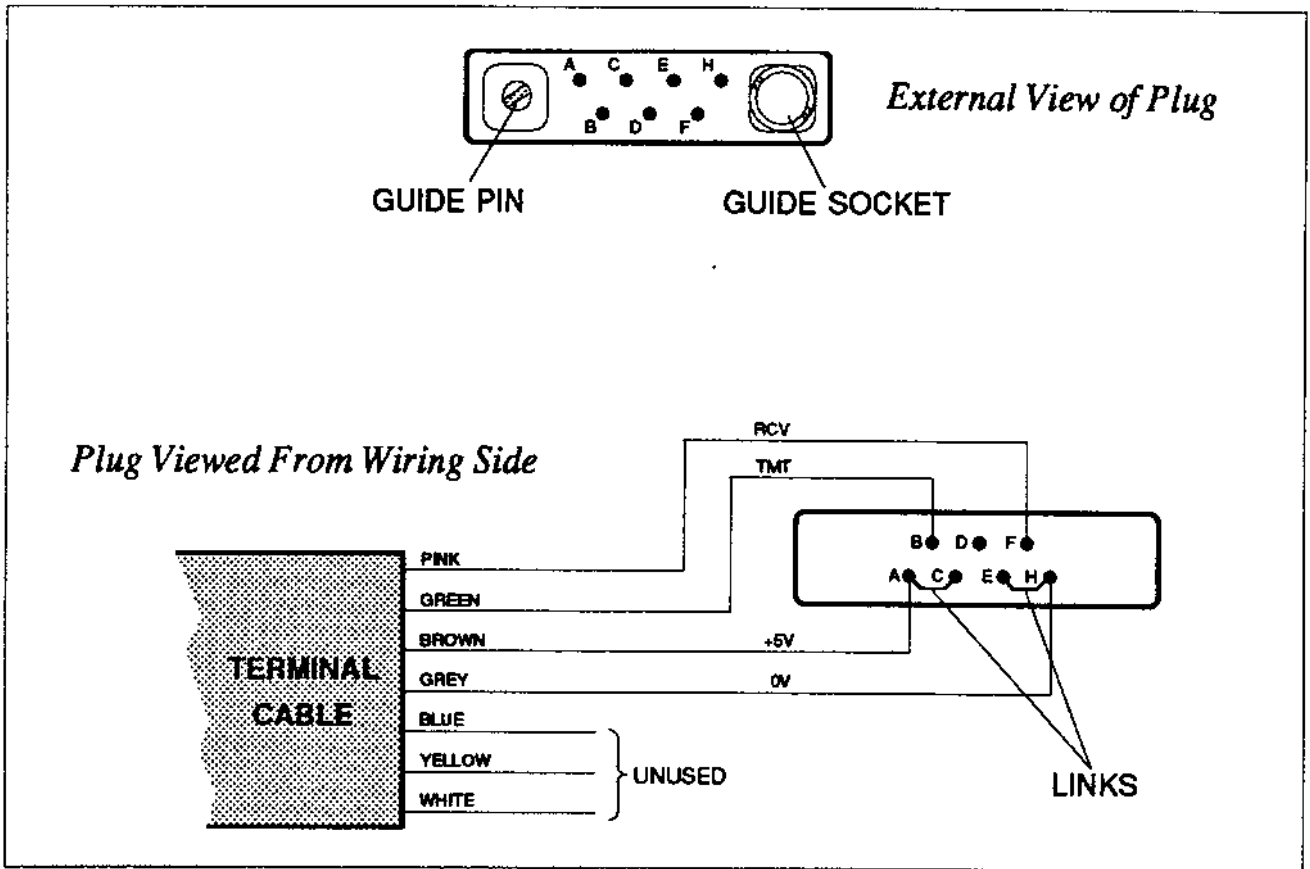

Figure 3.2 8263 Cable Wiring & Pin Designations

Display

The 32-character display (Figure 3.3) comprises 2 rows of 16 LCD characters (7 × 5 dot matrix), with a contrast control for different viewing angles on the side of the unit.

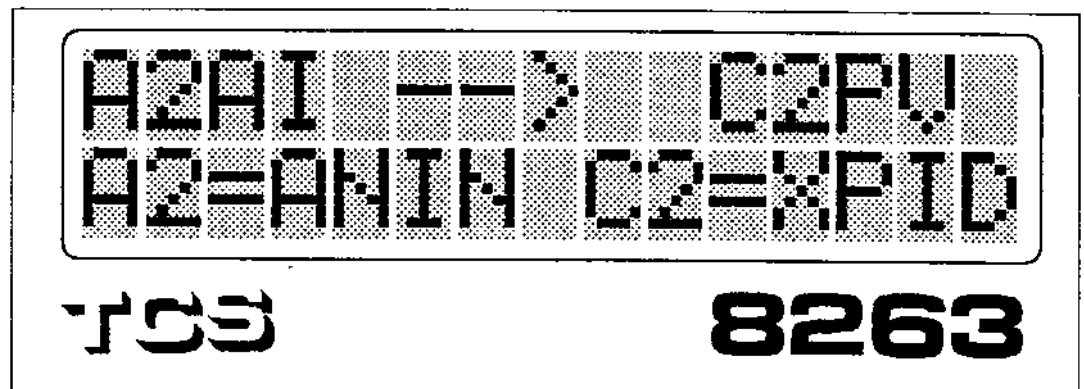

Figure 3.3 8263 Display

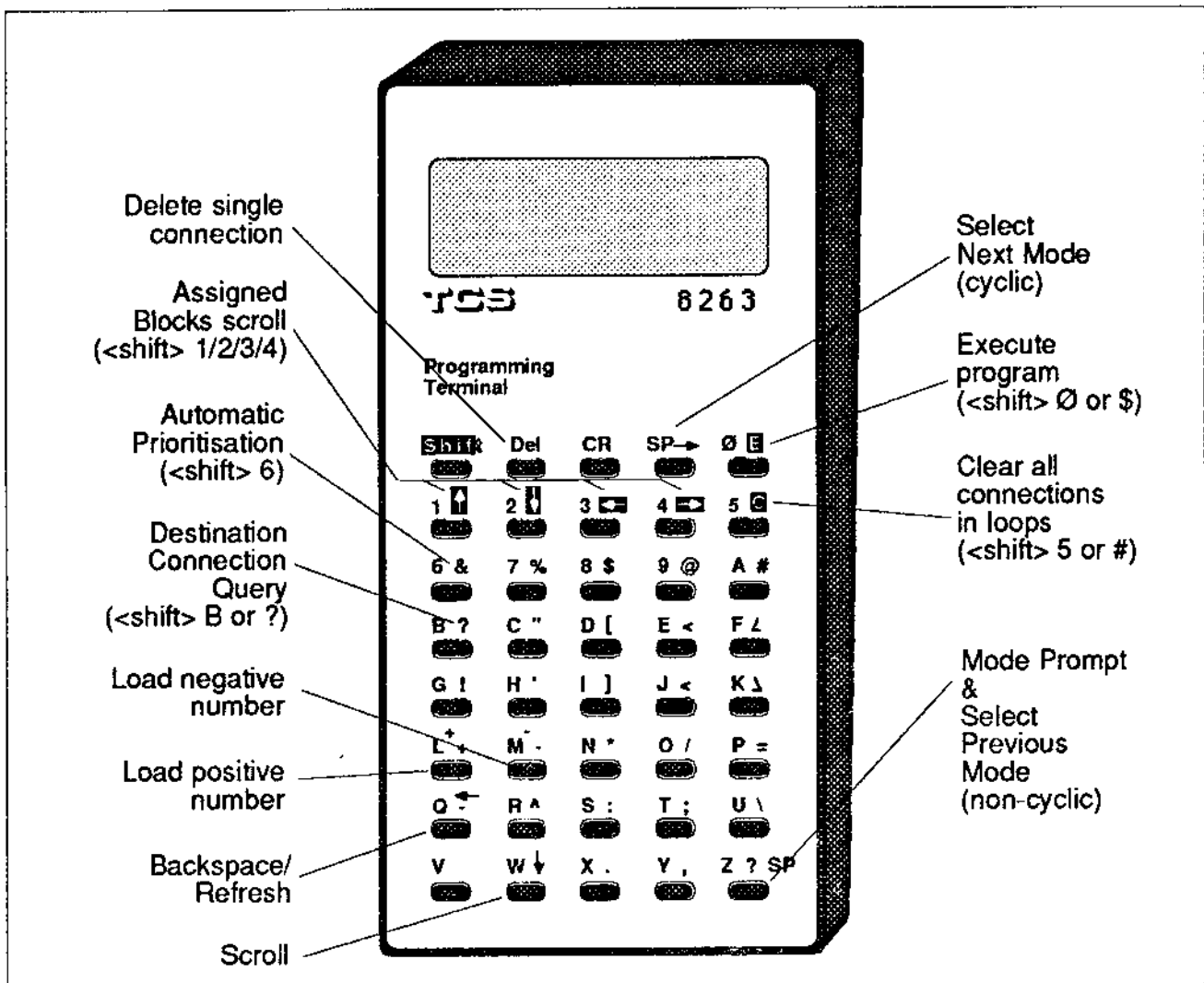

Figure 3.4 8263 Hand-Held Terminal Keyboard

Keyboard

The 40-key positive click-action keyboard (Figure 3.4) includes alphanumeric and special characters, control keys, editing and scrolling keys, and a shift mode key.

NOTE. To use shift mode, press the **Shift** key once, *then release it*. The next key pressed will transmit its shifted character, and then cancel shift mode. Pressing **Shift** a second time also cancels shift mode.

Special function keys are labelled in the Figure. Their uses are explained later in this chapter, in the relevant sections. The generally applicable Q, W, and Z control keys are described in their own section (*Terminal Control Keys*).

key label		ASCII code	SHIFT mode		key label		ASCII code	UNSHIFTED mode		The character in brackets is actually transmitted, when different from key label
Shift			Del	127	CR	13	SP	32	E (\$)	
									Ø	48
(^)	94	(*)	42	(<)	60	(>)	62	(#)	35	
1	49	2	50	3	51	4	52	5	53	
&	38	%	37	\$	36	@	64	#	35	
6	54	7	55	8	56	9	57	A	65	
?	63	"	34	[91	< (()	40	< (<)	60	
B	66	C	67	D	68	E	69	F	70	
!	33	'	39]	93	> (>)	41	> (>)	62	
G	71	H	72	I	73	J	74	K	75	
+	43	-	45	*	42	/	47	=	61	
L	76	M	77	N	78	O	79	P	80	
_	95	^	94	:	58	;	59	\	92	
Q	81	R	82	S	83	T	84	U	85	
				.	46	,	44	SP	32	
V	86	W	87	X	88	Y	89	Z	90	

Figure 3.5 8263 Hand-Held Terminal ASCII Codes

ASCII Codes

The 8263 terminal sends and receives data in 7-bit serial ASCII code at up to 9600 baud, via the RS232 interface. Figure 3.5 shows the codes transmitted by the 8263 for each of the keys, in unshifted and shifted modes (where applicable).

Terminal Initialisation

Baud rate setting is automatic, and there are no user switches to set. Just plug the 8263 Hand-Held Terminal into the socket on the front panel of the *powered-up* instrument. This disables the RS422 supervisory communications channel on the rear connector, and also prevents you changing the displayed loop via the pushbuttons.

The 8263 beeps and then very briefly displays 'SELECTING BAUD RATE'. It then displays 'SENDING Z AT ...', followed by baud rates of 300, 600, 1200, 2400, 4800, and 9600, until it has matched its baud rate to the one set up in the instrument.

A final beep means the 8263 has set its own baud rate correctly, and the display shows the **command mode** prompt:



?? CMD

Mode prompts are described later in this chapter.

NOTE. Powering up the Intelligent Loop Processor *after* the 8263 has been connected may produce a continuous beep and prevent terminal initialisation. If this happens, unplug the 8263 and then replug it into the powered-up instrument.

At power-up, with switch 2 of switchbank 3 ON, any loop programs held in the RAM capable of running are automatically started after an initialisation period that depends on the loop repeat times (and may be several seconds). The front panel display is the last one selected before power-down.

If switch 2 of switchbank 3 is OFF, the programs stored in EEPROM area 1 are automatically loaded to RAM and run after the usual initialisation period. The front panel display is the one that was active when the configuration was stored in area 1.

Terminal Modes

Command mode, displayed on the 8263 as the ?? CMD prompt, is one of the three terminal operating modes you use to configure and run a control strategy. Starting at the top of the hierarchy, the complete list of modes and their uses is:

?? CMD — Command Mode. Access to standard or instrument status parameters (e.g. instrument identity, displayed loop number, switch settings).

?? BCMD — Block Command Mode. Block installation, inspection, editing, and parameterisation.

?? BCL — Block Connection Mode. Block interconnection, and the inspection/editing/deletion of existing connections. Automatic block execution prioritisation, and program initiation.

Figure 3.6 summarises the three terminal modes and how to move from one to another using the 8263 control keys. Press the SP (space) key to move to a 'lower' mode, and the Z key to move to a 'higher' mode.

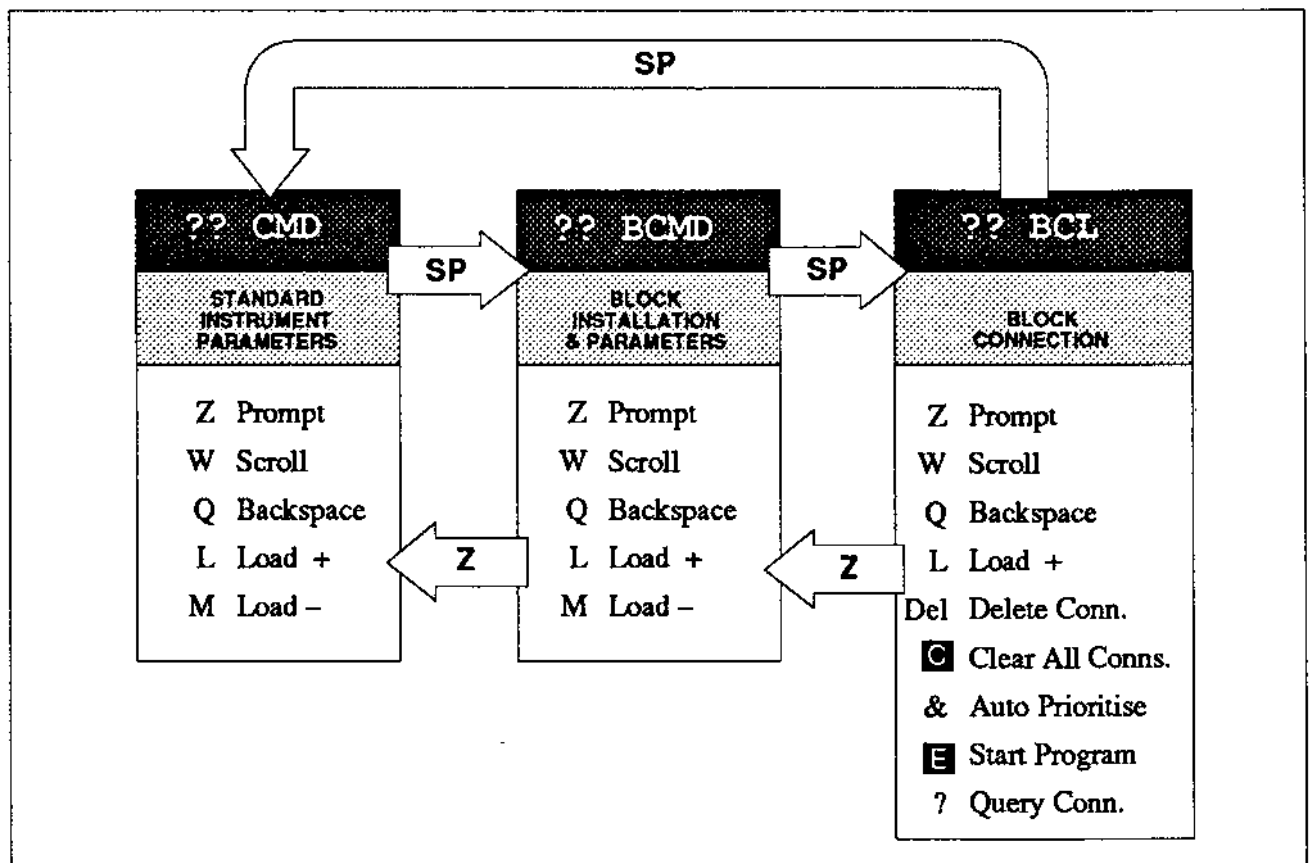

Figure 3.6 Hand-Held Terminal Modes

NOTE. To move back 'up-mode' after having just moved 'down-mode', you must press *Z* *twice* to start with. After that, single presses move you further up-mode. The same applies when first moving up-mode after working in a lower mode.

The SP key has a cyclic action: after ?? BCL comes ?? CMD again, and so on. The action of the Z key is not cyclic: pressing Z has no effect on the ?? CMD display.

Within each mode, control keys perform the special mode functions needed. These functions are indicated in Figure 3.6 and are described in the sections on each mode, below.

COMMAND MODE — ?? CMD

This section describes using the 8263 terminal keys within *command mode*. Full details of all the parameters accessible from command mode are given in Chapter 6.

The command mode prompt, ?? CMD, is always displayed first after the 8263 has been powered up and initialised.

Accessing a Parameter

To access one of the command mode parameters, key in its two-character mnemonic in response to the ?? CMD prompt. The instrument responds by transmitting to the 8263 the current value of the parameter, with the number of characters, sign, and decimal places appropriate to the parameter chosen. (Parameter data formats are described later in this chapter.)

Example 1 *Accessing the II parameter.*

ACTION	8263 DISPLAY
■ Initialise terminal.	?? CMD
■ Press the I key.	I
The display clears, and the first mnemonic character is echoed at the top left position.	
■ Press the I key (again).	II>3823

The second mnemonic character is echoed at the next display position, and the instrument replies to the II command with the current parameter value (for example 3823).

The > symbol denotes that the value has the format HHHH in Table 4.2, i.e. four hexadecimal digits.

The first digit of the parameter value (i.e. 3) flashes on and off, which in this case indicates that new data may now be entered, starting with this most significant digit. Flashing is represented here by *outlining* the relevant character.

Keying In a Parameter Value

Having accessed a parameter, you may write new data to it by first *keying in* the required characters, and then *loading* the data into the instrument's parameter storage area.

Example 2 *Keying in the value 3668 for the II parameter.*

ACTION	8263 DISPLAY
--------	--------------

- Ready to enter new data.

II>3823

- Press the 3 key.

II>3⁸23

The flashing 3 is replaced with the new value (another 3 in this case), and the next digit (the 8) flashes, waiting to be overwritten.

- Press the 6 key.

II>36²3

The flashing 8 is replaced with the 6, and the next digit (the 2) flashes.

- Press the 6 key (again).

II>366³

The flashing 2 is replaced with the 6, and the last digit now flashes.

- Finally, press the 8 key.

II>3668

The flashing 3 is replaced with the 8, and all the digits now stop flashing. This signifies that the data is ready to be loaded into the memory of the instrument.

Loading a Parameter Value

When all the new characters of the parameter have been correctly keyed into the display, as described in the previous section, you can then load the data into the instrument's parameter storage area. This is done by pressing either of two load keys, depending on the *polarity* of the data:

- For positive data press the **L** key (labelled with red +)
- For negative data press the **M** key (labelled with red -).

Normally these two keys are ordinary character keys; they act as *load keys* only when data is ready to be loaded.

Example 3 Loading the value 3668 into the *II* parameter.

ACTION	8263 DISPLAY
■ Data ready to be loaded.	II>3668
■ Press the L (+) key.	II>3668

Hexadecimal data is always positive, so the **L** key is used.

The display blinks as the data loads, and the complete parameter is then echoed to show that it has been successfully loaded.

The first digit (the 3) is again flashing to indicate that the whole parameter can be over-written, as described in the previous section.

Terminal Control Keys

In command mode, you can use the **Q** (backspace), **W** (scroll), and **Z** (prompt) *terminal control keys* to help configure the instrument more efficiently.

These special keys are described together in a later section of this chapter (*Terminal Control Keys*). See also Figure 3.4 for a summary of the 8263 keyboard functions.

BLOCK COMMAND MODE — ?? BCMD

This section describes using the 8263 terminal keys within *block command mode*. For details of all the fixed and assigned function blocks and their parameters accessible in this mode, please refer to Chapters 4 and 5.

The block command prompt, ?? BCMD, can be accessed from command mode by pressing the **SP** key once, or from block connection mode by pressing **Z** twice. See Figure 3.6.

Block command mode is used to install control blocks and assigned blocks at addresses in the instrument's database, and also to inspect and parameterise all block types (fixed and assigned). Four special keys let you rapidly inspect/edit all the assigned blocks in the instrument. These *assigned blocks scroll* keys are shown in Figure 3.4, and are explained at the end of this section.

Installing an Assigned Block

To install an assigned block at one of the instrument's 2-digit addresses, key in the address in response to the ?? BCMD prompt. The instrument responds by transmitting to the 8263 display the address and name of the block currently there, if any. At this stage you can install (or replace) a block at the address, by keying in and loading its four-character name.

NOTE. 6370/80 instruments have 12 assigned block addresses available (01 to 12); 6372 and 6382 instruments have eighty (01 to 80).

Example 4 Assigning an ADD2 block to address 01

ACTION	8263 DISPLAY
■ Block command prompt.	?? BCMD
■ Press the Ø key.	Ø Ø5 EXP

ACTION**8263 DISPLAY**

The prompt clears, and the first digit of the address is echoed at the top left position of the display.

In addition, the last address that happens to have been accessed (and any block there) appears on the lower display line, for reference. (This is helpful when you are installing a long list of blocks.)

- Press the 1 key.

01 SUBT

The lower display line clears. The last digit of the address is echoed at the second display position, and the instrument responds with the name of the block currently there (SUBT in this case).

The initial character of the current block name (i.e. S) flashes on and off and alternates with an asterisk symbol (*). In this section, this is represented diagrammatically by *underlining* and *outlining* the relevant character. If there is no block already at the address, only the flashing asterisk appears, where the first character of the block name would have been.

- Key in ADD2.

01 Add2*

The existing block name (if any) clears, and Add2 is echoed, followed by the flashing asterisk. The asterisk indicates that the load key-stroke is awaited.

NOTE. When first entered, characters following the initial one appear in *lower case*.

- Finally, press the L key.

01 ADD2

Use the L key to load block names, which are regarded as 'positive' data.

The ADD2 block is successfully loaded into address 01 of the instrument, as shown by the whole name reappearing in *block capitals*. The initial A 'flashes/asterisks' to indicate that the block can again be over-written with another, as just described.

Installing a Control Block

In 6372 and 6382 instruments there are two control block addresses available — C1 and C2, for use in loops 1 and 2 respectively. You can assign any one of the four available control blocks (XPID, RPID, XCON, and RCON) to each address. This is done in an exactly similar way to installing an assigned block, described in the previous section:

- From the ?? BCMD prompt, key in the required control block address (i.e. C1 or C2). (As before, the lower line of the display reminds you of the last address accessed.)
- Now key in the control block name wanted at the address.
- Finally, press **L** to load the control block into the chosen address.

As an example, if you are assigning an RCON block to address C1, and have just pressed **L** to load the block, the display would show:

```
C1  RCON
```

The flashing **R** again indicates that overwriting is possible.

NOTE. If XCON or RCON blocks are installed at C1 or C2, the corresponding MANS blocks (M1 or M2) cannot be separately accessed because they are incorporated in the control blocks. Pressing M1 (or M2) displays the *control block* name instead of 'MANS', and the ??BCMD prompt returns if you press W.

Accessing Block Parameters

From the ?? BCMD prompt, you first access the block containing the required parameter by keying in its two-character address. (A table of *fixed block* addresses is given in Table 4.1 in Chapter 4; *assigned blocks* can have any available addresses.)

Then you can use the **W** control key to 'scroll' through the list of parameters in the block until you see the required one. Alternatively, you can key in a 2-character parameter mnemonic to display a particular parameter directly. At this stage you may inspect or edit the displayed parameter value.

Example 5 shows both these ways of accessing block parameters.

Example 5 Accessing parameter HR of the ANIN block at address A1

ACTION	8263 DISPLAY
■ Block command prompt.	?? BCMD
■ Key in A1.	A1 ANIN

You access the ANIN block by keying in its 2-character address (A1), as described in Example 4.

Now you can either scroll down to the required parameter, or access it directly. Both are now described.

Using the Scroll Facility.

- Press the **W** (scroll) key.

ST>0006
A1 ANIN

The first parameter in the list of ANIN parameters (ST) is displayed on the top line, with its current value. The first digit of the parameter value flashes on and off, indicating that new data could now be entered.

The lower line displays the address and block currently accessed, as a reminder.

- Press the **W** key (again).

HR>999.
A1 ANIN

The next parameter in the list of ANIN parameters (HR) appears. In this case its format is \pm Eng., i.e. in the range ± 9999 .

ACTION	8263 DISPLAY
--------	--------------

Direct Parameter Access. Accessing the block is as already described:

- The accessed block display.

A1 ANIN

- Press the Z (prompt) key.

?? BCMD

The Z key returns the ?? BCMD prompt to the display, *but the ANIN block remains accessed.*

- Key in HR.

HR@999.
A1 ANIN

The prompt clears, and the complete parameter with its current value is displayed, ready to be edited if required.

Entering a Parameter Value

In block command mode, you key in and load parameter values in the same way as for command mode, already described in the *Command Mode — ?? CMD* section, under *Keying In a Parameter Value* (Example 2). But in block command mode the display shows the block currently accessed, as a reminder, as well as the parameter being edited.

Example 6 Writing the value -1234 to parameter HR (ANIN block)

ACTION	8263 DISPLAY
--------	--------------

- Access the parameter.

HR@999.
A1 ANIN

The displayed current value of HR is +9999, with the first digit flashing. (Refer to the section *Parameter Formats* for details of polarity representation.)

- Key in 1234.

HR1234.
A1 ANIN

ACTION**8263 DISPLAY**

The old parameter value is replaced by the new value in the display, and all the digits now stop flashing. This signifies that the data is ready to be loaded into the instrument.

- Press the **M(-)** key.

HR1234-
A1 ANIN

A negative data value is wanted, so the *negative load key* is used to load the data into memory.

The complete parameter is echoed to show it has been successfully loaded, and the first digit (the 1) flashes to indicate that the parameter can be overwritten.

NOTE. Negative values are displayed with a minus sign in place of the decimal point. Positive values are displayed with a normal decimal point. The decimal point cannot be keyed in when entering a parameter value. It is set by the block's ST parameter, or is fixed for some parameters. Refer to the section *Parameter Formats* for details.

Assigned Blocks Scroll Keys —

In ?? BCMD mode, these four keys let you scroll through all the assigned block addresses, in either direction, in steps of one or five addresses. The scrolling action is obtained by pressing the shift key then either the 1, 2, 3, or 4 keys. Figure 3.4 shows the terminal keyboard and special keys.

They operate only when an assigned block address is displayed on the terminal, with the flashing asterisk at the first block name position (ready for input).

The keys act as follows, when assigned block address 'n' is currently displayed:

 **Up Arrow.** Press to display address $n + 5$, and the block name assigned there (if any). If $n + 5$ exceeds the maximum address number permitted for the instrument, the mode prompt is displayed instead.

 **Down Arrow.** Press to display address $n - 5$, and the block name assigned there (if any). If $n - 5$ is less than 1, pressing the key has no effect.

 **Left Arrow.** Press to display address $n - 1$, and the block name assigned there (if any). If $n - 1$ is less than 1, pressing the key has no effect.

 **Right Arrow.** Press to display address $n + 1$, and the block name assigned there (if any). If $n + 1$ exceeds the maximum address number permitted for the instrument, the mode prompt is displayed instead.

BLOCK CONNECTION MODE — ?? BCL

This section describes using the 8263 terminal keys within *block connection mode*.

The block connection prompt, which usually appears as ?? BCL Ln SC OK (for loop n), can be accessed from command mode by pressing the **SP** key twice. See Figure 3.6.

You use block connection mode to interconnect blocks, and to inspect/edit/delete existing connections. Auto-prioritisation of block execution, and program initiation, are also performed in this mode.

The Block Interconnection Mode Prompt

After powering up the Intelligent Loop Processor and accessing the block connection mode, the prompt usually appears as:

?? BCL L1 SC OK

Loops 1, 2 & 3. The **L1** means that the instrument fascia is displaying loop 1 control data (the *only* loop in 6370/80 instruments). 'L1' mode is used to configure connections to blocks in loop 1. **L2** would indicate that loop 2 was being displayed, and that loop 2 blocks could be connected to. **L3** would indicate that connections to blocks in 'loop 3' could be made, and that the front panel was in *display mode*. 'Loop 3' is the User Task 3 background program, and is not strictly a *loop* because it does not contain a control block. The background program is not automatically displayed, although you can direct values from it to the front-panel in display mode via the DISP block.

- To change loop number, just key in L2 (or L1 or L3) in response to the ?? BCL prompt. The mode prompt changes accordingly, and the appropriate loop number indicating LED on the instrument fascia lights up.

Sumcheck Error Message. The **SC OK** message confirms that there is no *sumcheck error* in any of the assigned blocks in the relevant loop of the instrument. If there were, the address of the block containing the error would replace **OK** in the message, and that loop would be halted.

Please refer to Chapter 10, Error Messages & Diagnostics, for details.

NOTE. Exceptionally, Control block and Manual Station block sumcheck errors are also flagged by the ??BCL mode prompt, but the remaining fixed blocks (that are assigned to valid loops via their FC parameters) are flagged by the SC parameter in *Command Mode*.

Configuring a Block Interconnection

To configure a block interconnection, first see that the prompt shows the same loop number as that assigned to the proposed destination block. Next key in the address of the block that is to be the *source* of the connection, followed by its particular outgoing connection mnemonic.

Then key in the address of the block that is to be the *destination* of the connection, followed by the required incoming connection mnemonic.

Example 7 Interconnecting ANIN & ADD2 blocks (AV to IA)

ACTION	8263 DISPLAY
--------	--------------

Inputting the Source Data.

- Access block connect mode

?? BCL L1 SC OK

- Key in A1.

A1* A1=ANIN

The prompt clears, and the source address is echoed, followed by a flashing asterisk. Also, the name of the block at address A1 is displayed on the lower line as confirmation.

NOTE. If there is *no* block at the chosen address (possible for assigned blocks), the equals sign is followed by space characters.

The flashing asterisk indicates that the outgoing connection mnemonic is awaited.

- Key in AV.

A1AV *
A1=ANIN

The outgoing connection mnemonic **AV** is echoed, and the flashing asterisk appears at the right-hand side of the display, where the next characters are awaited (the destination block's address).

ACTION**8263 DISPLAY**

Inputting the Destination Data. This is done in the same way as already described for the source data.

- Key in Ø11A.

```
A1AV   Ø11a*
A1=ANIN Ø1=ADD2
```

The address and incoming connection mnemonic of the ADD2 block Ø11A is echoed (in lower case), and the flashing asterisk shows that the loading key-stroke is awaited.

- Finally, press the L(+) key.

```
A1AV.OK. Ø11A
A1=ANIN Ø1=ADD2
```

The complete interconnection is displayed, with the message .OK. to show that it has been accepted into the instrument's database. The first character 'flashes/asterisks' indicating that you could edit the interconnection if required.

NOTE. If the destination block address is invalid (e.g. in the wrong loop) the flashing cursor returns instead to the start of the *destination* address field.

Reviewing & Editing Existing Block Interconnections

In block connection mode you can scroll through and review all the interconnections stored in loop 1 (or loops 2 and 3 for 6372/82 instruments).

The order in which the interconnections appear as you scroll through them depends on whether or not you have *auto-prioritised* the control strategy. (Auto-prioritisation is described in a later section.)

NOTE. Connections appear in the list in order of execution, not in the order you keyed them in. Execution order is specified by the block FC parameters (highest priority first). The list order will appear random if the priorities are all at their default zero values.

You can edit or completely overwrite a displayed interconnection, or delete it from the database. There is also a control key which deletes *all* the interconnections in a loop.

New & Existing Interconnections. When you configure a new interconnection, it will either *add* to the list of existing interconnections, or *replace* an existing interconnection without increasing the total number.

Which happens depends on the new interconnection. If it links an existing source to a new destination, it *adds* to the list. If it links a new source to an existing destination, it *replaces* the old interconnection going to that destination. This is because you cannot have more than one source feeding a single destination (a conflict would arise), but a single source can fan out to any number of destinations. Figure 3.7 shows the two sorts of interconnection.

To configure a new interconnection, you can always input it in its entirety, as shown in Example 7 above. Alternatively it may be easier to modify a similar *existing* interconnection, as shown in Example 8.

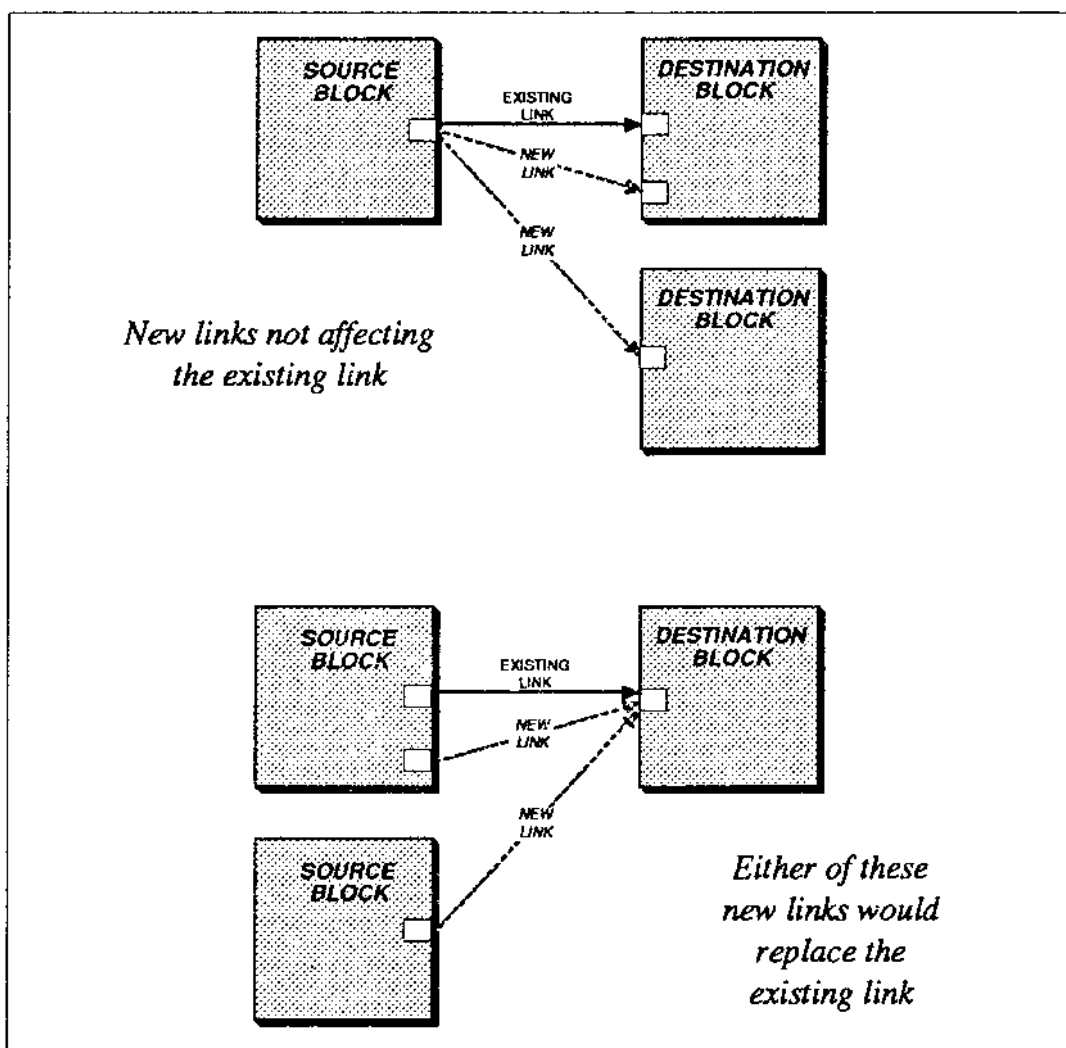

Figure 3.7 Interconnection Types

Example 8 *Reviewing and editing an existing interconnection*

ACTION	8263 DISPLAY
--------	--------------

- Access mode prompt.

?? BCL L1 SC OK

- Press the **W** key as needed to scroll to required connection.

A2AI --> C1PV
A2=ANIN C1=XPID

The flashing character shows that editing is possible. Note that the **.OK.** message that first appeared when the interconnection was input has been replaced by the --> symbol. This 'arrow' shows the signal flow direction. In this example, PV is to be edited to SR.

At this stage you could overwrite the whole interconnection in the same way as you originally input the data. Alternatively, you can use the *positive load key* (**L**) to skip over the half of the interconnection that you don't want to alter.

- Press the **L (+)** key.

A2AI --> C1PV
A2=ANIN C1=XPID

The source data is to remain, and the destination data is to be altered. Pressing the load key causes the flashing to skip to the first character of C1, inviting editing.

- Key in **C1SR**.

A2AI --> C1sr*
A2=ANIN C1=XPID

You must overwrite the address even though it is not to be altered. **C1SR** echoes (partly in lower case), and a flashing asterisk shows that the complete edited interconnection is ready to be loaded.

- Press the **L (+)** key.

A2AI .OK. C1SR
A2=ANIN C1=XPID

The complete connection (in block capitals) echoes on the display, with the **.OK.** message to confirm its acceptance into the database. The first character flashes, inviting further editing if needed.

NOTE 1. The new interconnection has not replaced the existing one, but has *added* to the list of interconnections. This is because it has linked an existing source (A2AI) to a new destination (C1SR).

NOTE 2. If you edit, add, or delete a connection all programs are halted.

Deleting A Single Interconnection

In block connection mode the **Del** key is used to delete an individual interconnection:

- Scroll to the interconnection, using the **W** key.
- Press the **Del** key.

The displayed interconnection is cleared from the instrument's database, and the next one in the list is displayed instead (or the mode prompt, if the deleted link was last in the cyclic list). All programs are halted.

Deleting All Interconnections

In block connection mode you use the **C** key to delete all the interconnections in the loop. All *fixed block* sumcheck errors are also cleared at the same time:

- Access the block connection mode prompt for the relevant loop, $n = 1, 2$ or 3 :

?? BCL Ln SC OK.

(Changing loop number in 3-loop instruments is explained on page 3.21.)

- Press the **Shift** key, release it, then press the **C** key (i.e. the **5** key).

The message **DELETE CONNECTIONS (Y/N)** appears, allowing you to change your mind and abort the delete operation.

Press **N** to exit and return directly to the mode prompt, or **Y** to execute the delete. A **.WAIT.** message appears while all the block interconnections in the loop are being cleared. Then the mode prompt returns.

NOTE 1. Only the *interconnections* are cleared from the loop database. Parameter values and installed blocks are unaffected.

NOTE 2. Interconnections to blocks with illegal loop numbers (i.e. other than 1, 2, or 3) are not cleared.

Block Execution Order Auto-Prioritisation

In block connection mode the **&** key is used to *autoprioritise* the blocks in your control strategy.

(The Function Control parameter (FC), block execution priority numbers, and autoprioritisation are explained in Chapter 4, page 4.22.)

- Access the block connection mode prompt for the relevant loop, n = 1, 2 or 3:

?? BCL Ln SC OK.

(Changing loop number in 2-loop instruments is explained on page 3.21.)

- Press the **Shift** key, release it, then press the **&** key (i.e. the **6** key).

A **.WAIT.** message appears while the blocks in the loop are being autoprioritised. Then the mode prompt returns.

The C and D digits of the FC parameters of all the blocks in the loop (with inputs) have now been automatically assigned priority numbers by the instrument. If running, the loop control program is halted.

Control Program Execution

At instrument power-up, any valid control programs automatically start running. To restart halted programs without interrupting the power you use the program execute key, **E**.

- Access the block connection mode prompt. (The loop number is irrelevant):

?? BCL Ln SC OK.

- Press the **Shift** key, release it, then press the **E** key (i.e. the **0** key).

A **.WAIT.** message appears briefly, then the mode prompt returns. All loop programs capable of running do so, after a short initialisation period. This is confirmed by a steady digital display on the instrument front panel for each running loop.

NOTE. When a loop restarts, the control block may initialise in *Forced Manual* mode. To exit this mode you must write to the mode enabling/selecting bits of the control block's ES parameter; the front panel pushbuttons do not help. Please refer to page 4.65.

Interconnection Destination Query

In block connection mode the query key (?) is used to display the source of an interconnection to a given destination, if any exists.

- Access the block connection mode prompt for the destination block's loop (n = 1, 2, or 3):

```
?? BCL Ln SC OK.
```

- Press the **Shift** key, release it, then press the blue ? key (i.e. the **B** key). A query appears at the left of the screen, alternating with a flashing asterisk.
- Key in the two-character address of the block, followed by the mnemonic of the input being queried, e.g.: **C1PV**.
- The complete interconnection is displayed in the usual way, with the source on the left and the destination you typed in now over on the right side of the screen. E.g.:

```
A1A1 --> C1PV  
A1=ANIN C1=XCON
```

- If there is no source to the destination you entered, the block connection mode prompt reappears instead.

TERMINAL CONTROL KEYS — Q, W, Z

This section describes the three terminal control keys Q, W, and Z (shown in Figure 3.4). Use of the Z key has already been mentioned in this chapter (page 3.7), and Examples 5 and 8 above illustrate uses of the W key.

Backspace / Refresh Key — Q

The Q key (also marked with a red backward arrow symbol) lets you in certain circumstances backspace the flashing cursor so that you can overwrite a mis-keyed character before it is loaded into the instrument's database. Each press of the Q key backspaces the cursor by one character, and then the correct character(s) may be entered from that position in the normal way.

The Q key can be used in different ways at several different stages of a configuration, as follows.

Editing a Parameter Value. You can use the Q key during the keying-in of a four-character parameter value (in ?? CMD or ?? BCMD modes) to backspace and then re-enter characters. This must be done *after* entering the two-character mnemonic and *before* the data is loaded (with the L or M load keys).

If you press the Q key when the flashing digit is the first (most significant) one, the whole display clears and the parameter mnemonic with its *current* value is displayed instead. This is the 'refresh' facility, which is particularly useful for following a continuously changing parameter value on the Hand-Held Terminal.

Editing the Name of a Block Being Assigned. The Q key can be used to alter a block name being assigned to an address (in ?? BCMD mode). This must be done *after* entering the two-character address and *before* the block name is loaded (with the L load key).

Unlike the previous use of the Q key (altering parameter values), there is no 'refresh' facility in this case.

NOTE. Before loading an edited block name you can return to the original name by pressing the Z key to display the prompt, and then re-entering the block address.

Editing the Source/Destination of an Interconnection. During the keying-in of the *source* data (in ?? BCL mode), you can backspace and overwrite only the first three characters with the Q key. Once the fourth character has been entered, the flashing cursor jumps across to the destination data, at the right of the display, and cannot be returned.

Any of the four *destination* data characters, however, may be backspaced and edited via the Q key, before the load key has been pressed.

Scroll Key — W

The W key (also marked with a red downward arrow symbol) is used to scroll through the parameters or block interconnections in a cyclic list. Each press of the W key causes the next item in the list to be accessed and displayed, ready for data input/inspection.

How the W key works depends on whether parameters or interconnections are being scrolled.

Scrolling Parameters. (?? CMD and ?? BCMD modes). The W key 'scrolls' only if a parameter mnemonic is already being displayed on the terminal, with the flashing cursor at the start of the character field. If you are part-way through keying in data or the mode prompt is present, the W key is ignored or treated as an illegal character.

When scrolling through parameters in ?? BCMD mode, the *block address and name* are displayed on the lower line as a reminder of which block you are looking at.

Repeated pressing of the W key scrolls endlessly around the cyclic parameter list. To escape and return to the prompt mode you must press the Z key.

Scrolling Block Interconnections. (?? BCL mode). The W key 'scrolls' from the mode prompt, or from any displayed interconnection (provided you are not part-way through keying-in data). The cyclic list of interconnections includes the mode prompt, which is immediately returned to if the Z key is pressed.

The *order* of the block interconnections in the list has been explained in the section *Reviewing & Editing Existing Block Interconnections*, on page 3.21.

Mode Prompt — Z

The Z key (also marked with a red 'query') has two main uses:

- Moving from a mode prompt to the next higher one. This is explained in the *Terminal Modes* section, on page 3.7.
- Escaping to the current mode prompt, from scrolling or data entry operations. This usage is now explained.

Escaping to Current Mode Prompt. You can press the Z key during *any* stage of keying-in or scrolling operations, in any of the terminal modes, to return immediately to the current mode prompt.

The Z key works during mnemonic and address entry as well as parameter data entry, and can be used to 'abort' an input operation completely so that a fresh start can be made.

Pressing the Z key is also the only way to escape from scrolling round cyclic parameter lists (in ?? CMD and ?? BCMD modes), and lets you access a parameter directly without having to scroll to it. In ?? BCMD mode, the Z key returns you to the mode prompt, but the current block remains accessed. Example 5 includes use of the Z key for direct parameter access (on page 3.16).

PARAMETER FORMATS

Every Intelligent Loop Processor parameter has a specific data *format* that defines its type, range, sign, and decimal point position (where appropriate). For example, the AO parameter of the Analogue Output block is in 'engineering units', in the range -9999 to +9999, with decimal point position set by the block's ST parameter. ST is itself a 'status word', consisting of four hexadecimal digits, ranging from 0000 to FFFF, with no decimal point.

Chapters 4, 5, and 6 of this manual give parameter tables for fixed blocks, assigned blocks, and command mode parameters, respectively, which show the data formats of all the parameters by means of symbols. These format symbols are defined in Table 4.2, Chapter 4.

Parameter Type

In Table 4.2 the 'type' of parameter associated with each format is listed, i.e. quantity in engineering units, percentage, hexadecimal digit, binary digit, etc.

To help you recognise them, some parameter types have special symbols displayed on the Hand-Held Terminal directly after their two-character mnemonics. 'HHHH' format parameters display the > symbol, and 'string variables' (four ASCII characters) display the ' symbol after the mnemonic. (Example 1 on page 3.9 illustrates the > symbol, displayed by the II parameter to show that the four following characters are hexadecimal.)

Range & Polarity

The range indicates how many digits must be entered for each parameter type, and the span of the data.

Certain parameters can be entered as either positive or negative values (bipolar), others are always positive, and some are unsigned (e.g. status words). This is shown in Table 4.2 with the 'range' information.

Both *positive* and *unsigned* parameter values are loaded into the instrument's database using the **L(+)** load key. *Negative* values are loaded with the **M(-)** load key. This has been described in the section *Loading a Parameter Value* on page 3.11, and illustrated in most of the Examples throughout this chapter.

To economise on display space, the sign of the parameter value is indicated by the representation of the *decimal point*, as explained in the next section.

Decimal Point Position

A decimal point never need be entered for a parameter, and in fact cannot be keyed in.

Many parameters have fixed decimal point positions, e.g. format '100%', which always appears with two decimal places. Others have decimal point positions set by a status word parameter (ST), e.g. format '±Eng.', which can have from 0 to 4 decimal places depending on the value of the status word. Some parameters have no decimal point at all, e.g. format 'HHHH'. Table 4.2 summarises all this information.

Decimal Point Representation. In the Hand-Held Terminal display, the decimal point can appear in two forms.

- For *positive* values, it is the ordinary dot symbol on the baseline of the numbers. LR = +70.00 in this example:

LR70.00 A1 ANIN

- For *negative* values, it is a minus sign where the decimal point should be. LR = -70.00 this time:

LR70-00
A1 ANIN

HAND-HELD TERMINAL ERROR CONDITIONS

Whilst using the 8263 Hand-Held Terminal you will occasionally press an invalid or inappropriate key. The result will be either that the 8263 completely ignores the illegal key-stroke, or that it 'aborts' the whole input (or logical section of it) and reverts to a known previous state.

Chapter 10, *Error Messages & Diagnostics*, describes these possible error situations and their effects, as well as instrument failure errors. Please refer there for full details.

Chapter 4

FIXED FUNCTION BLOCKS

The instrument provides you with a number of *function blocks* that let you define the interface between analogue and digital signals, setpoints, control, and the displays.

Function blocks take in analogue or digital signals via their inputs, process them in a variety of ways, and then pass the results on via their outputs. You connect the configured function blocks together so that the signals can flow between them (and the field) to execute your control strategy.

There are two types of function block in this instrument:

- **Fixed blocks**, which are dealt with in this chapter
- **Assigned blocks**, covered in the next chapter.

Fixed blocks carry out a range of operations including input/output, control, filtering, and totalisation.

Each fixed block has a unique address or 'location' in the instrument's memory, and cannot be moved or replicated for multiple use. (The only exceptions to this are the four Control blocks; please see the note on the next page.)

Table 4.1 lists all the fixed blocks in the Intelligent Loop Processor series of instruments.

Instrument	Block*	Address*	Type
6370/80	ANIN	A1 to A4	Analogue Input
	ANOP	B1 to B4	Analogue Output
	DGIN	DI	Digital Inputs (8-way)
	DGOP	DO	Digital Outputs (8-way)
	XPID	} C1 (see Notes)	PID Control
	RPID		PID Ratio Control
	XCON		XPID with Manual Station
	RCON		RPID with Manual Station
	ALRM	E1	Alarm Block
	MANS	M1	Manual Station [See Note 3]
	GENP	GP	General Purpose
	6372/82	ANIN	A1 to A8
ANOP		B1 to B4	Analogue Output
DGIN		DI	Digital Inputs (8-way)
DGOP		DO	Digital Outputs (8-way)
XPID		} C1 to C2 (see Notes)	PID Control
RPID			PID Ratio Control
XCON			XPID with Manual Station
RCON			RPID with Manual Station
ALRM		E1 to E2	Alarm Block
MANS		M1 to M2	Manual Station [See Note 3]
LLAG		F1 to F2	Lead/Lag Filter
DTIM		D1 to D2	Deadtime
CHAR		G1 to G2	Characteriser Block
DISP		DS	Display
TOTL		T1 to T2	Totalisation
GENP		GP	General Purpose

*As displayed on the Hand-Held Terminal

Table 4.1 Fixed Blocks

NOTE 1. You can assign any one of the four control block types to address C1, and, for 6372/82 instruments, repeat the process for address C2. C1 and C2 can have the *same* control block types assigned if required.

FIXED BLOCKS

NOTE 2. Assigning blocks to addresses is explained in Chapter 3 (and in the User Guide), and is the same for Control blocks and Assigned blocks.

The control block at address C1, and Manual Station block at M1 must be assigned to operate in loop 1 (via the FC parameter), and (in 2-loop instruments) the blocks at C2 and M2 must operate in loop 2. This is for reasons of loop timing and front panel display.

The other paired blocks (viz. LLAG, DTIM, CHAR, ALRM, and TOTL) may operate in either loop.

NOTE 3. MANS blocks are incorporated into XCON and RCON blocks when these are installed (at C1 or C2). You cannot then individually access an incorporated MANS block because its parameters then form part of the control block's parameter set.

Key to Block Connection Diagrams

Figure 4.1 shows the meanings of the symbols used in the block connection diagrams throughout this chapter.

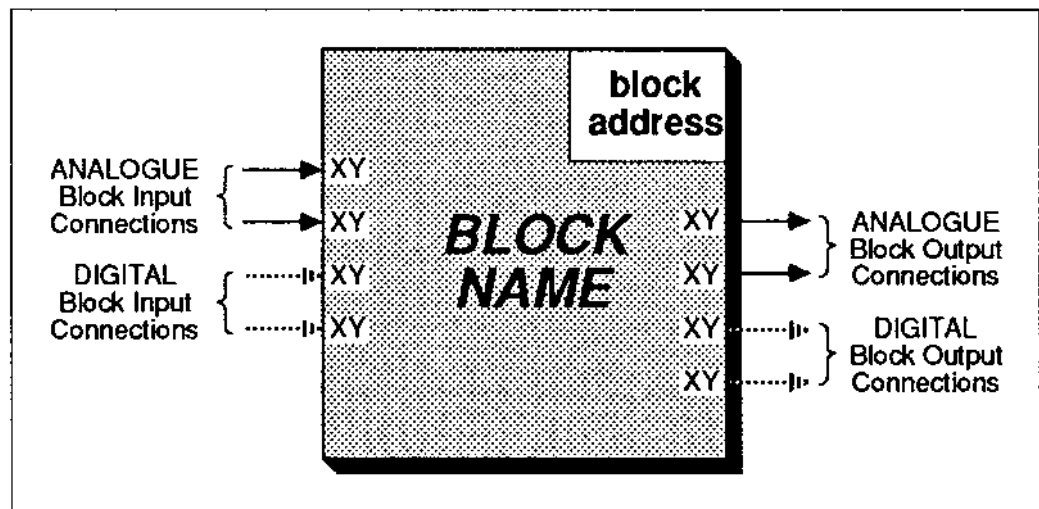

Figure 4.1 Key to Block Connection Diagrams

NOTE. Pin numbers mentioned in these diagrams refer to the *instrument backplane connector*, not to the particular sleeve or bin used to house the instrument.

Key to Parameter Diagrams

Figure 4.2 (a fictional parameter) and the notes below it explain the symbols you will find in the parameter diagrams used throughout this chapter.

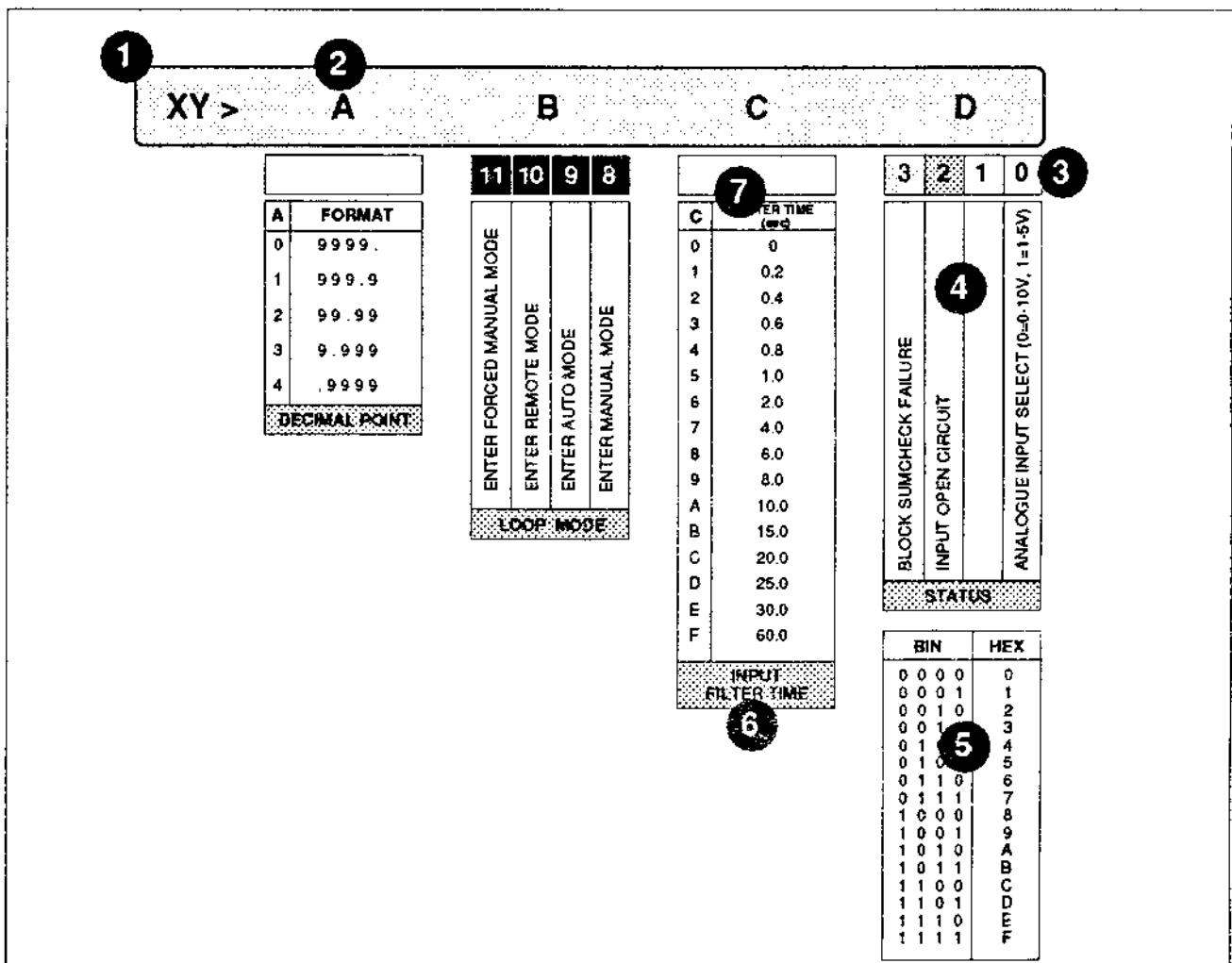

Figure 4.2 Symbols Used in Parameter Diagrams (Example Only)

- Notes:**
- 1** The shaded area represents the display of the Hand-Held Terminal. It shows a two-letter parameter mnemonic ('>' means hexadecimal notation), followed by four hexadecimal digits (labelled A, B, C, and D).
 - 2** Each hexadecimal digit contains four binary digits, making a total of 16 bits, numbered 0 to 15. The bit-numbering is shown for digits B and D; the rest follow on in order finishing with bit 15 in digit A.

FIXED BLOCKS

- 3 In these diagrams, bit numbers are shown only for bits having *individual* significance. This applies to digits B and D in the example of Figure 4.2. Other bits are left un-numbered.

Bits that can only be monitored (read-only) are shaded with a *dark* tone, like bit 2. Bits that can only be written to (write-only) have *white numbers* on a black background, like bits 8 to 11. Write-only bits reset as soon as they are entered and executed and so always read back as 0. Bits that can be altered only under certain conditions (conditionally read/write) are shaded with an *intermediate* tone, like bit 3. Freely alterable (read/write) bits are *unshaded*, like bit 0.

- 4 The statements under each of the bit numbers are *true* if the bit value is 1, and are *false* if the bit value is 0. For example, bit 3 equal to 1 means there *is* a 'Block Sumcheck Failure'; whereas bit 3 equal to 0 means *no* 'Block Sumcheck Failure'. Where alternatives are unclear, the meanings of the *both* the bit states are spelled out (as for bit 0 in this example).

Bits with *no* statements underneath them (like bit 1 in the Figure) have not been allocated a function, and have 'don't care' values.

- 5 A binary/hexadecimal conversion table helps you to translate the parameter digits A, B, C, and D into bit-patterns (and *vice versa*).
- 6 To help you find the right digit, each information panel has a title summarising the function of the digit it refers to.
- 7 When bits have no individual significance, a table under the relevant digit shows what each hexadecimal value means. For example, digits A and C in Figure 4.2.

Key to Data Format Symbols

Data comes in a variety of formats and units. Table 4.2 lists the meanings of the symbols used in this manual to stand for the various formats. Please refer to the *Parameter Formats* section in Chapter 3 for more details.

Symbol	Type	Range	Decimal Point
0/1	Digital Inputs/Outputs	0 or 1	None
9999	Dimensionless Value	0000 to +9999	Defined by ST
±9999	Dimensionless Value	-9999 to +9999	Defined by ST
±Eng.	Engineering Units	-9999 to +9999	Defined by ST
±Eng./s	Engineering Units/sec	-9999 to +9999/s	Defined by ST
Eng.	Engineering Units	0000 to +9999	Defined by ST
100	ST defines Units	00.00 to +99.99	Fixed
±100	ST defines Units	-99.99 to +99.99	Fixed
1000	ST defines Units	000.0 to +999.9	Fixed
±1000	ST defines Units	-999.9 to +999.9	Fixed
100%	Percentage Units	00.00 to +99.99%	Fixed
±100%	Percentage Units	-99.99 to +99.99%	Fixed
1000%	Percentage Units	000.0 to +999.9%	Fixed
100%/s	Percentage Units/sec.	00.00 to +99.99%/s	Fixed
HHHH	Status Words (hex)	0000 to FFFF	None
H	Hexadecimal digit	0 to F	None
FP	Analogue I/P / O/P	-10 ³⁸ to +10 ³⁸ approx.	Floating Point
AB	Block Address	A to Z, 0 to 9	None

Table 4.2 *Data Format Symbols*

ANIN: ANALOGUE INPUT BLOCK

Block Function

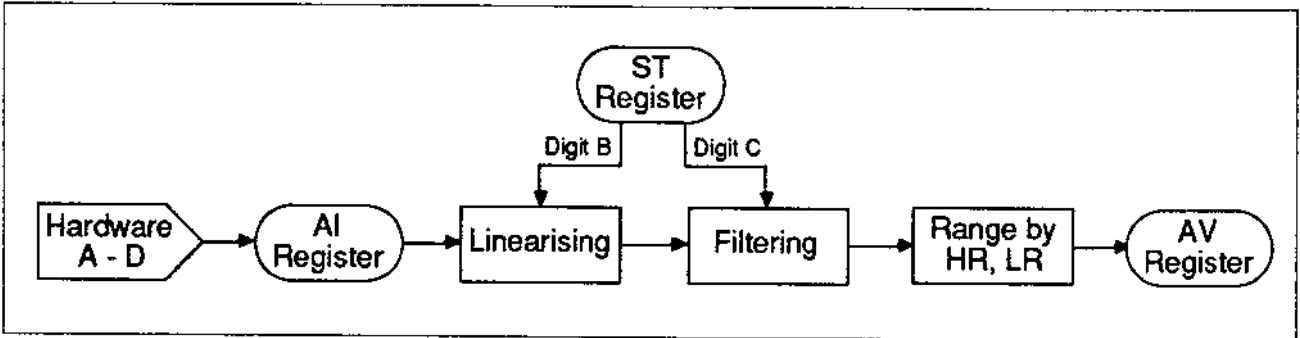

Figure 4.3 Analogue Input Block Schematic

Please refer to Figure 4.3. After hardware A-to-D conversion by the CPU, the value of each analogue input is stored as a *percentage* in the AI register, where it is available as the AI parameter. Linearising and filtering occur according to what instructions have been programmed into the ST register. The resulting value is then converted to *engineering units* over the range defined by the LR and HR parameters. Finally, the processed engineering units value is written to the AV register, where it is available as the AV parameter.

Block Connections

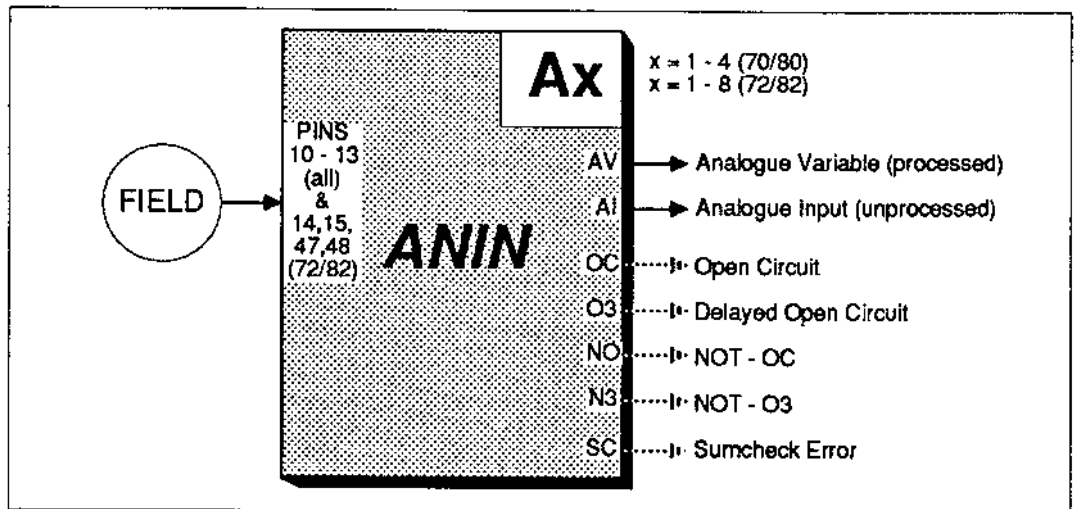

Figure 4.4 Analogue Input Block Connections

Figure 4.4 represents all the ANIN blocks (totalling 4 or 8) in the instrument. Each block has its own address and parameter set, and single input from the field.

Inputs From the Field. To set up a particular ANIN block's analogue input from the field as 0 - 10V, or 1 - 5V, you configure bit 0 (in digit D) of the block's ST parameter to be 0 or 1 respectively; the same input pin is used for both ranges.

Table 4.3 lists the instrument pin numbers used for the ANIN block inputs; also included are the equivalent 7950 Universal Packaging System customer terminal numbers. Please see the relevant Facts Card for other sleeve equivalent terminal numbers.

Instrument	ANIN Address	Instrument Pin	7950 Terminal
(All)	A1	10	1
	A2	11	2
	A3	12	3
	A4	13	4
6372/82	A5	14	31
	A6	15	32
	A7	47	33
	A8	48	34

Table 4.3 ANIN field input pin numbers

Outgoing Connections. The connections coming out of the block are detailed in Table 4.4.

Code	Connection	Function	Format*
AV	Analogue Variable	Processed (linearised, filtered and scaled) value of the input.	FP
AI	Analogue Input	Unscaled, unprocessed input value.	FP
OC	Open Circuit	OC sets to 1 immediately on open-circuit or out-of-range.	0/1
O3	Delayed Open Circuit	Sets to 1 if input is open-circuit for >3 secs (allows brief PV interruptions to be ignored). Resets 3 secs after cct restored	0/1
NO	NOT-OC	Inverse of OC	0/1
N3	NOT-O3	Inverse of O3	0/1
SC	Sumcheck Error	Latches to 1 on sumcheck failure	0/1

Table 4.4 ANIN Outgoing Connections

Block Parameters

Table 4.5 lists the ANIN parameters and the units or format in which they are expressed.

Mnemonic	Parameter	Format*
ST	Block Status	HHHH
HR	Analogue I/P High Range	±Eng.
LR	Analogue I/P Low Range	±Eng.
AI	Analogue I/P (unscaled)	100%
AV	Analogue Variable (scaled)	±Eng.

Table 4.5 ANIN Block Parameters

Each of these parameters is covered in more detail in the sections that follow.

ST Block Status

Figure 4.5 shows the meanings of each of the four hexa-decimal digits in the ST parameter of the Analogue Input block. (The symbols used in the parameter diagram are explained in Figure 4.2.)

Decimal Point Selection — Digit A

Digit A selects the decimal point position for all the parameters in the ANIN block that are in engineering units, i.e. HR, LR, and AV.

Input Processing Routines — Digit B

Digit B selects which of the 15 digital processing routines is applied to the ranged analogue input. To select 'No processing' set B equal to zero.

- **Square Root Function (B = 1).** *0-10V range:* block output derives from $V_{out} = \sqrt{V_{in} \times 10}$; *1-5V range:* block output derives from $V_{out} = \sqrt{[(V_{in} - 1) \times 4] + 1}$.

*See Table 4.2 for an explanation of these formats

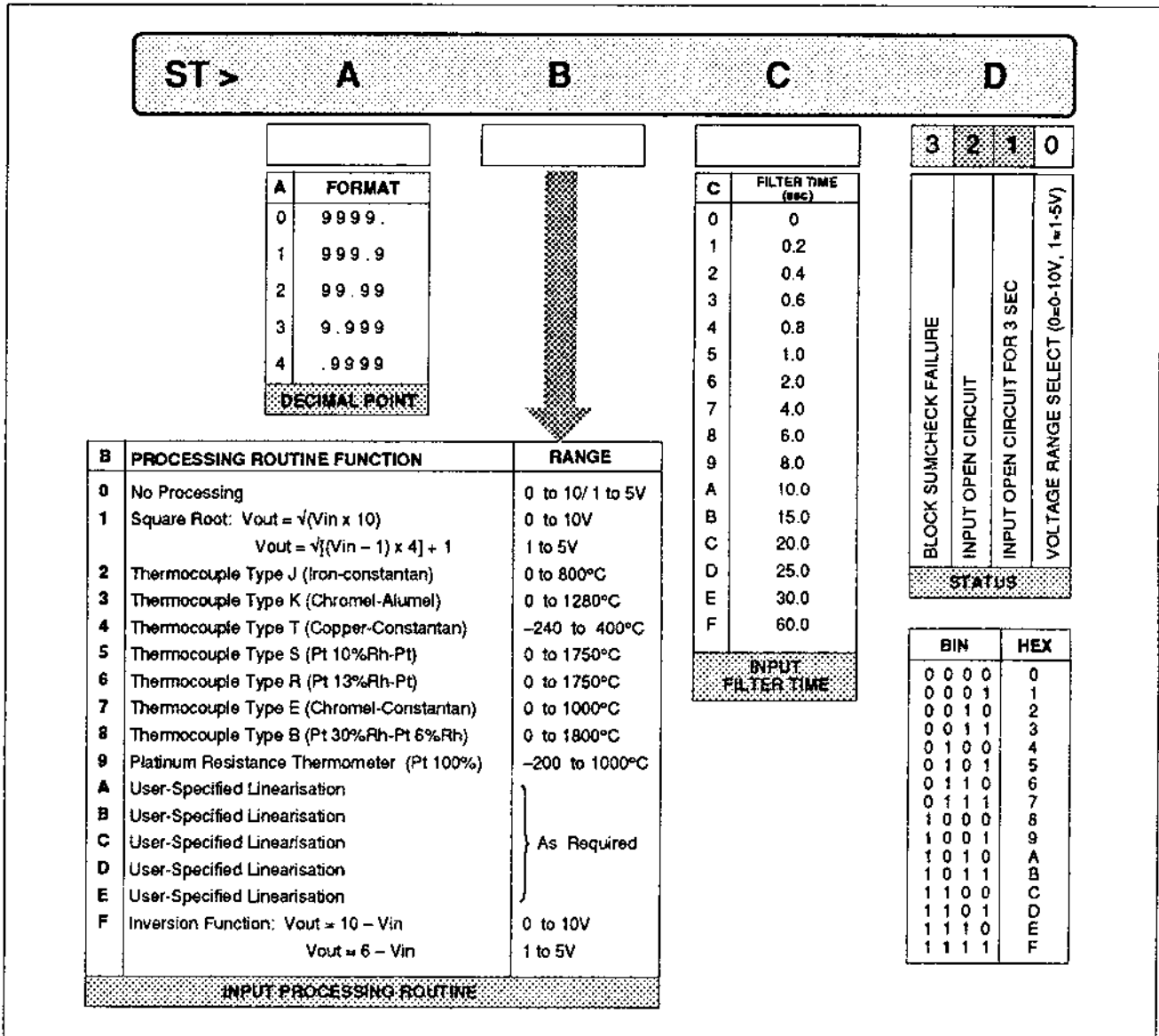

Figure 4.5 ST Parameter — Analogue Input Block

- Thermocouple & Platinum Resistance Thermometer Linearisations (B = 2 to 9).** Figure 4.5 shows the maximum temperature range in which each linearisation will function correctly. *Make sure the programmed setpoint span of the control loop (defined by HR and LR) always lies within this range.* Also, for maximum resolution, you should scale the thermocouple amplifier or input converter to give a 0 - 10V output for the LR to HR input span.

Example 1 Type J thermocouple over range 0 - 800°C.

Set the analogue input ranges to LR = 000.0, and HR = 800.0 (1 decimal place). Resolution = 0.1°C.

Example 2 *Type J thermocouple over range 0 - 400°C.*

Set LR = 000.0, and HR = 400.0 (1 decimal place). Also, scale the thermocouple amplifier or input converter to give a 0 - 10V output for a 0 - 400.0°C input.

Resolution = 0.1°C.

Example 3 *Type J thermocouple over range 0 - 100°C.*

Set LR = 00.00, and HR = 99.99 (2 decimal places). Scale the thermocouple amplifier to give a 0 - 10V output for a 0 - 100.0°C input. Resolution (theoretical) = 0.01°C.

NOTE. The maximum resolution for any of the thermocouple ranges is 0.01°C.

- **User-Specified Linearisations (B = A to E).** These are reserved for extra 'custom' functions. You can specify your own linearisation functions as 30-element break-point tables over the required range of values. TCS will quote a price and delivery for installing them in the instrument.
- **Inverse Function (B = F).** 0 - 10V range: block output derives from $V_{out} = 10 - V_{in}$; 1 - 5V range: $V_{out} = 6 - V_{in}$. Inversion is carried out *before* the input is ranged by LR and HR and further processed. This means that when the ranged analogue variable is displayed on the instrument's digital readout, it is the *inverted* value (if selected).

Example 1 *Program parameters ST>1F00, HR = 500.0, LR = 000.0.*

The inverted Vout, and the analogue variable displayed on the instrument's front panel (or read back via the serial data links) will be as follows:

Vin	Vout	Displayed Variable
0.0V	10.0V	500.0
2.5V	7.5V	375.0
5.0V	5.0V	250.0
7.5V	2.5V	125.0
10.0V	0.0V	000.0

Input Filter Time — Digit C

Digit C selects the input filter time constant for the analogue variable. It is a simple, digitally implemented, first order filter.

Status Bits — Digit D

Digit D tells you about the status of the ANIN block.

- **Block Sumcheck Failure — Bit 3.** Automatically latches to logic 1 whenever the CPU detects a sumcheck failure in any of the parameters of the ANIN block. To clear this condition, re-enter any corrupted parameters, and then reset bit 3 to logic 0.
- **Input Open Circuit — Bit 2.** Automatically sets to logic 1 immediately the CPU detects an open circuit or under-range (1 - 5V only) condition in the block's analogue input channel. Bit 2 is read-only and resets to logic 0 only when the analogue input is back in range.
- **Input Open Circuit for 3 Seconds — Bit 1.** Sets to logic 1 when an open circuit or under-range (1 - 5V only) in the block's analogue input channel has persisted for more than 3 seconds. Bit 1 is read-only and resets to logic 0 only when the analogue input has been back in range for >3 seconds.
- **Voltage Range Select — Bit 0.** Lets you select the voltage range for the block's analogue input channel.

HR & LR Analogue Input Ranging

HR (High Range) and LR (Low Range) define in engineering units the span of the block's analogue variable input, AV. HR must be greater than LR.

For 0 - 10V analogue inputs, the HR value is equivalent to an input of 10V on the block's analogue input pin, and LR is equivalent to an input of 0V.

For 1 - 5V analogue inputs, the HR value is equivalent to an input of 5V on the block's analogue input pin, and LR is equivalent to an input of 1V.

AI Analogue Input

The AI (Analogue Input) parameter represents the instant-aneous value of the analogue input as a percentage (0 to 99.99%) of the full-scale voltage range. AI is evaluated before any ranging, processing, or filtering has been applied to the signal (see the block schematic in Figure 4.3).

For 0 - 10V inputs, 0V gives an AI of 0%, and 10V gives an AI of 99.99%.
For 1 - 5V inputs, 1V gives an AI of 0%, and 5V gives an AI of 99.99%.

AV Analogue Variable

The AV (Analogue Variable) parameter represents the value of the analogue variable input signal, in engineering units, after it has been ranged, processed, and filtered (see the block schematic in Figure 4.3).

ANOP: ANALOGUE OUTPUT BLOCK

Block Function

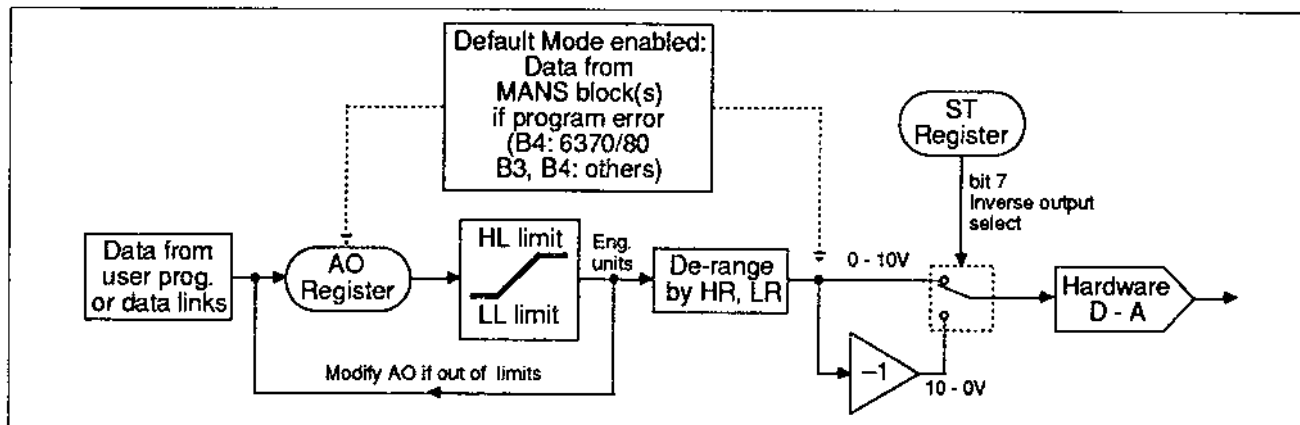

Figure 4.6 Analogue Output Block Schematic

Please refer to Figure 4.6. The analogue output value is stored in the AO register in engineering units (available as the AO parameter). The variations of AO are limited to an operating range set by the output limit parameters LL and HL. After de-ranging by HR and LR, AO is converted to a (limited) analogue 0 - 10V signal ready for output. For the B4 block only, the output signal can also be 0 - 20mA or 4 - 20mA (2 - 10V), both isolated.

Reverse Action. The ST parameter can be set to *invert* (reverse) the analogue output. In this case, as AO varies from LR to HR, the output signal varies from 10V to 0V (subject to limiting).

Manual Intervention on Program Halt — Default Mode. *Applicable to ANOP block B4 only (6370/80 instruments), or B3 and B4 only (6372/82 instruments). Default Mode is enabled when switch 1 of Switchbank 3 is ON.*

In *default mode*, if an error occurs causing the program to halt, the D-to-A converter is automatically kept updated by the Manual Station block output MO instead of by the AO register, allowing manual intervention. The ANOP block's HL and LL parameters are disabled. Please refer to Figure 4.6. AO itself is also kept updated by the MANS block (instead of the user program) so that later return to program control is bumpless. Block B4 is updated by MANS block M1, and block B3 (6372/82 only) by MANS block M2.

When the program first halts, MO is updated once from AO to make the transfer bumpless. Specifically, MO% is calculated from AO (engineering units) as:

$$MO = \frac{100(AO-LR)}{HR-LR}$$

Subsequently, during the program halt, AO is back-calculated from MO as:

$$AO = \frac{MO}{100}(HR-LR) + LR$$

The ANOP block's output to the field is held at the voltage equivalent of MO%. E.g. for 0 - 10V range, MO at 40%, the field output is 4V.

Note that the MANS block rate and output limits remain active during program halt.

This means that if Loop 2 program halts (or is not being used) with default mode selected, then ANOP block B3 becomes inaccessible, because it is effectively 'hard-wired' to M2. A simple remedy is to run Loop 2 with a dummy XCON or MANS block in it

NOTE. With default mode enabled and all loops running, digital output DO08 in the DGOP block holds at logic 1. If *any* loop program halts, DO08 flags this by resetting to logic zero. You can still connect a digital output to DO08 in default mode, but this output ANDs with the 'program running' flag (i.e. only if *both* are high is the DO08 output also high).

Block Connections

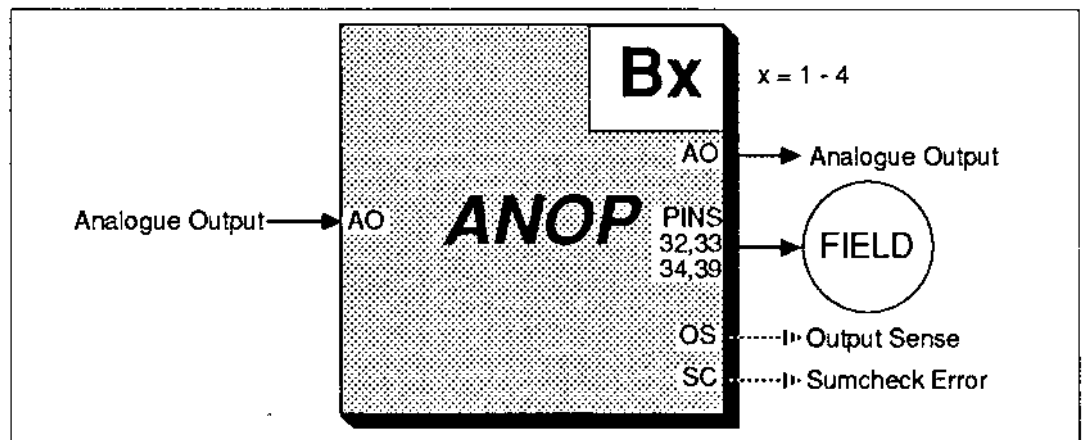

Figure 4.7 Analogue Output Block Connections

Figure 4.7 represents all the ANOP blocks in the instrument (four). Each block has its own address, parameter set, and output(s) to the field. Blocks B1 to B3 are voltage outputs; B4 outputs both voltage and current (see Table 4.8).

Incoming Connections. The (only) connection coming into the ANOP block is summarised in Table 4.6.

Code	Connection	Function	Format*
AO	Analogue Output	Analogue Output value, limited to lie between LL and HL.	FP

Table 4.6 ANOP Incoming Connections

As AO varies from the low range (LR) to the high range (HR), the output signal to the field varies from 0 to 10V, limited by the output limit parameters LL and HL. For the B4 block only, the variation ranges also include 0 - 20mA (corresponding to 0 - 10V), and 4 - 20mA (corresponding to 2 - 10V).

However, bit 7 of the ST parameter can be set for *inverse operation*. In this case, as AO varies from LR to HR the analogue output signal varies from 10 to 0V (or 20 - 0mA, etc.).

Outgoing Connections. Table 4.7 shows the outgoing connections from the ANOP block, available for connecting to another block (or blocks).

Code	Connection	Function	Format*
AO	Analogue Output	Analogue Output value	FP
OS	Output Sense	Copies ST bit 7 (inverse O/P select)	0/1
SC	Sumcheck Error	Latches to 1 on sumcheck failure	0/1

Table 4.7 ANOP Outgoing Connections

Outputs to the Field. Table 4.8 lists the instrument pin numbers used for the four ANOP block field outputs; also included are the equivalent 7950 Universal Packaging System customer terminal numbers. Please see the relevant Facts Card for other sleeve equivalent terminal numbers.

ANOP Address	Instrument Pin	7950 Terminal
B1	32	37
B2	33	38
B3	34	39
B4 (voltage)	39	40
B4 (current -, +)	43, 45	41, 42

Table 4.8 ANOP Field Output Pin Numbers

Block Parameters

Table 4.9 lists the ANOP parameters and the units or format in which they are expressed.

Mnemonic	Parameter	Format*
ST	Block Status	HHHH
HR	Analogue O/P High Range	±Eng.
LR	Analogue O/P Low Range	±Eng.
HL	High Output Limit	±Eng.
LL	Low Output Limit	±Eng.
AO	Analogue Output Value	±Eng.
FC	Function Control Register	HHHH

Table 4.9 ANOP Block Parameters

Each of these parameters is covered in more detail in the sections that follow.

ST Block Status

Figure 4.8 shows the meanings of each of the four hexa-decimal digits in the ST parameter of the Analogue Output block. (The symbols used in the parameter diagram are explained in Figure 4.2.)

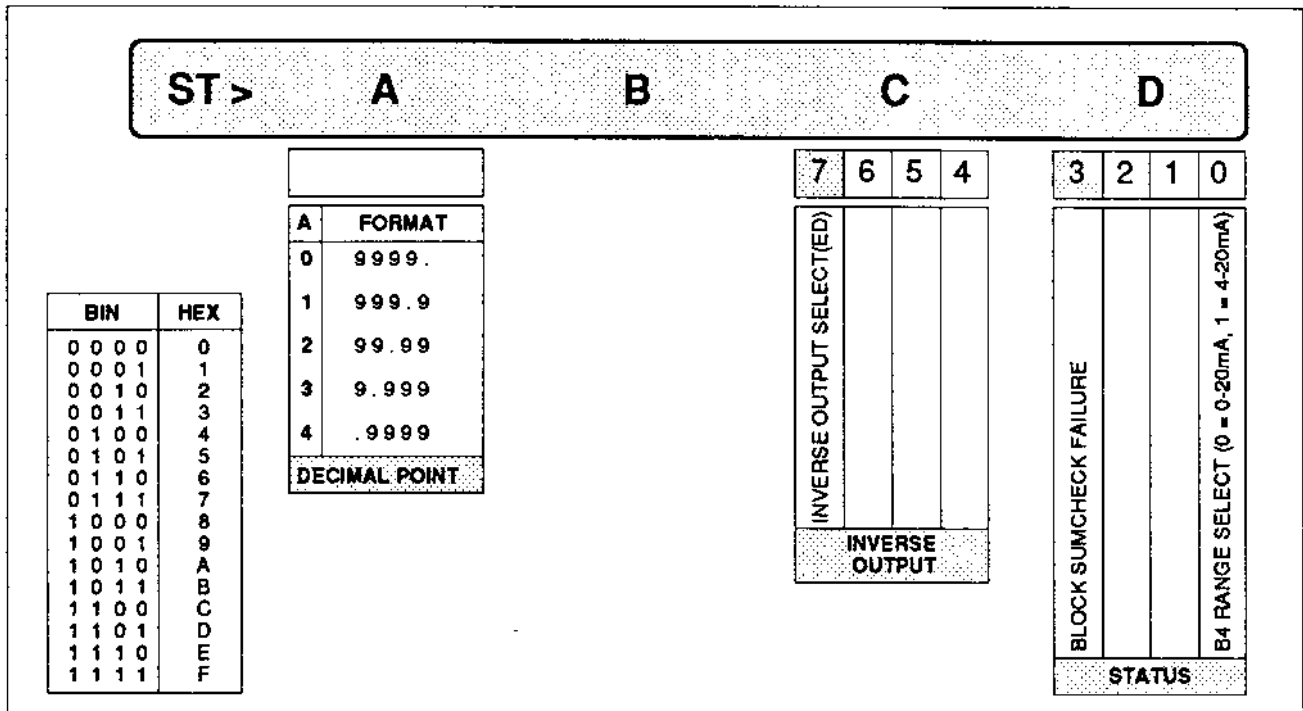

Figure 4.8 ST Parameter — Analogue Output Block

*See Table 4.2 for an explanation of these formats

Decimal Point Selection — Digit A

Digit A selects the decimal point position for all the parameters in the ANOP block that are in engineering units, i.e. HR, LR, HL, LL, and AO.

Inverse Output Select(ed) — Digit C

- **ANOP Blocks B1 & B2.** Bit 7 (read-write) of digit C selects whether the analogue output is *normal* or *inverse* acting (see Figure 4.6, Block Schematic). With normal output, as AO increases from LR to HR the output signal increases from 0V to 10V. With inverse output, as AO increases from LR to HR the signal *decreases* from 10V to 0V.
- **ANOP Blocks B3 & B4.** Normal/inverse action is set by *switchbank 2*, not by bit 7 (read-only). Switches 7 and 8 set B3 and B4 outputs, respectively; 'off' = normal action, 'on' = inverse action.

Status Bits — Digit D

- **Block Sumcheck Failure — Bit 3.** Automatically latches to logic 1 whenever the CPU detects a sumcheck failure in any of the parameters of the ANOP block. To clear this condition, re-enter any corrupted parameters, and then reset bit 3 to logic 0.
- **Block B4 Current Range Select — Bit 0.** Selects 0 - 20mA (0 - 10V) or 4 - 20mA (2 - 10V) operation for ANOP block B4 only. Other blocks are fixed at 0 - 10V operation.

HR & LR Analogue Output Ranging

HR (High Range) and LR (Low Range) define in engineering units the span of the block's analogue output, AO. HR must be greater than LR.

The HR value is equivalent to an output of 10V on the block's analogue output pin, and LR is equivalent to an output of 0V. (See p 4.14 for additional B4 block ranges.)

NOTE. Changing HR and/or LR values also changes the values of the HL and LL parameters. See below for details.

HL & LL Analogue Output Limits

The HL (High Limit) and LL (Low Limit) parameters restrict the range (in engineering units) of AO. They operate on AO whatever its source: another function block in an application program, or a serial data link. HL must be greater than LL. Also, HL cannot exceed HR, and LL cannot be less than LR.

HL and LL values are *automatically* altered by the instrument whenever you alter HR and LR. (The converse is not true: HL and LL do not affect HR and LR.) One aim of these automatic changes is to keep the HL-LL span at a constant ratio to the HR-LR span. The other is to keep the HL-LL span in the same relative position within the HR-LR span.

To achieve both these aims the instrument alters HL and LL to hold ratios $(HL-LL)/(HR-LR)$ and $(HR-HL)/(LL-LR)$ at constant values before and after HR, LR changes.

AO Analogue Output

The AO parameter defines in engineering units the value of the analogue output signal to the field. AO is scaled by HR and LR, and is always limited by HL and LL (see earlier sections).

AO may be written to from either of the serial data links, or you may define its value as the output of another functional block.

FC Function Control Register

The FC parameter occurs in every function block (fixed or assigned) that is to be executed in a *User Task* (i.e. Loop 1 or 2, or the background program, see Chapter 9). Blocks such as ANIN and DGIN are run in Task 2 (instrument real I/O updates) and so have no FC parameter. Except for the pseudo I/O blocks AOCB and DOCB, the rule is that *blocks without input connections have no FC parameter*. FC holds the **loop number** in which the block is to operate, and the **priority number** of execution of the block within that loop.

When you are parameterising the blocks in your control strategy, you must enter the *loop number* you want each block to work in, via its FC parameter. For 6370/80 instruments this can only be Loop 1; for the other instruments it can be Loop 1, 2, or 3.

The *priority number* of a block is the order in which it is executed, once per loop repeat time, within the control strategy. ('Execution' means the block having its inputs read and processed, and its outputs updated with the new val-

ues.) Priority numbers can run from 0 to 255, priority 0 being the highest (first block executed). Priority numbers need not be consecutive; it is their order that is important.

When you are parameterising the blocks in your control strategy, you don't need to give them priority numbers. The instrument itself will decide this for you automatically, from the logic of your strategy, if you press the '&' key in ??BCL mode before running the program.

If you wish, you can always overwrite the automatically assigned priority numbers. Figure 4.9 shows the meanings of the four hexadecimal digits of the FC parameter.

NOTE 1. Auto-prioritising your control strategy optimises the loop execution speed and avoids possible timing problems. *Incorrectly prioritised blocks can seriously disrupt the operation of the control strategy.*

NOTE 2. Changing or overwriting an FC parameter halts all user programs.

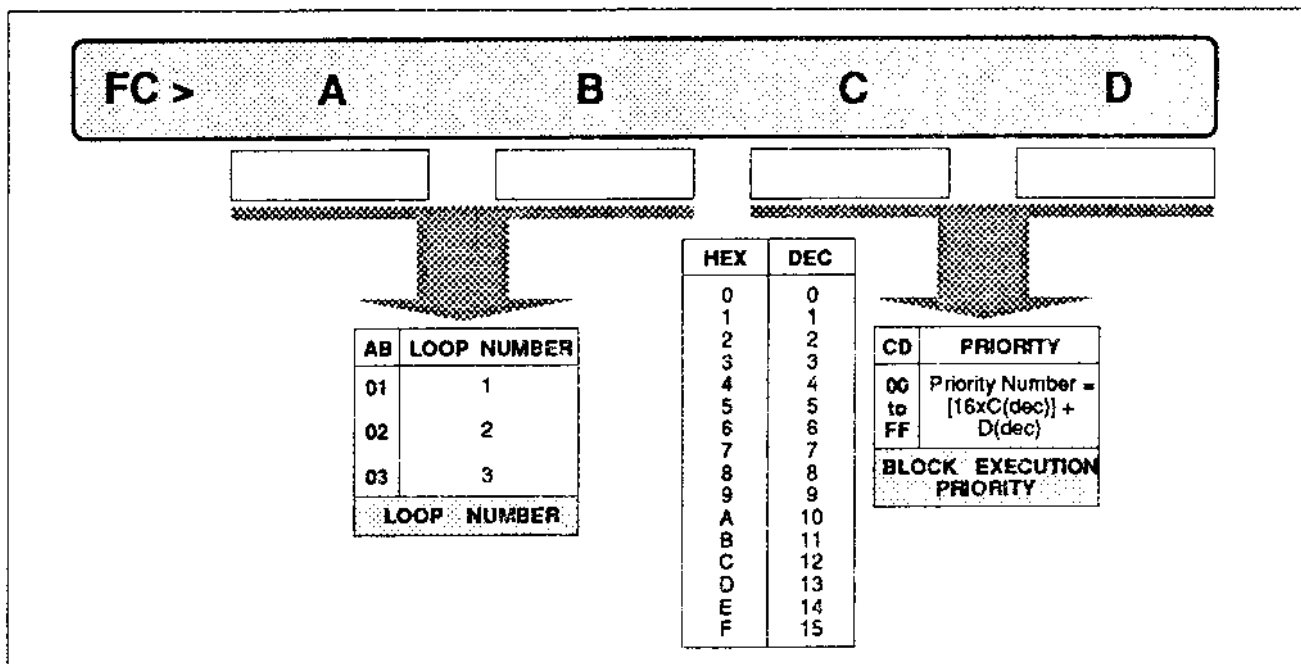

Figure 4.9 FC Parameter — Analogue Output Block

Loop Number Selection — Digits A & B

A & B set the loop number in which the block operates.

Priority Number Selection — Digits C & D

C & D set the block's execution order within the whole strategy, as a two-digit hexadecimal number.

DGIN: DIGITAL INPUT BLOCK

Block Function

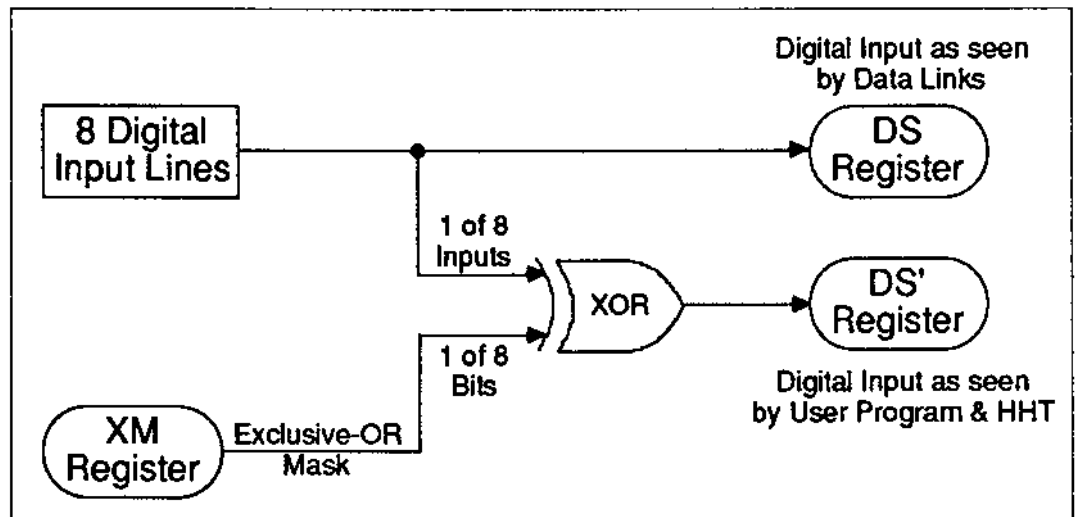

Figure 4.10 *Digital Input Block Schematic*

Please refer to Figure 4.10. The logic state of each of the 8 digital input lines is held in the DS register (available via the RS422 data link as the DS parameter).

Logic State Inversion. You can *invert* the logic state of any digital input for use in your control strategy or user application program. This is done by setting the appropriate bit in the XM parameter to logic 1 (see below for details).

The *actual* (uninverted) logic state of the input, as monitored by the DS parameter, remains unchanged. Only the block output to the strategy or program (held in the DS' register) is inverted. The Hand-Held Terminal monitors the DS' parameter.

Block Connections

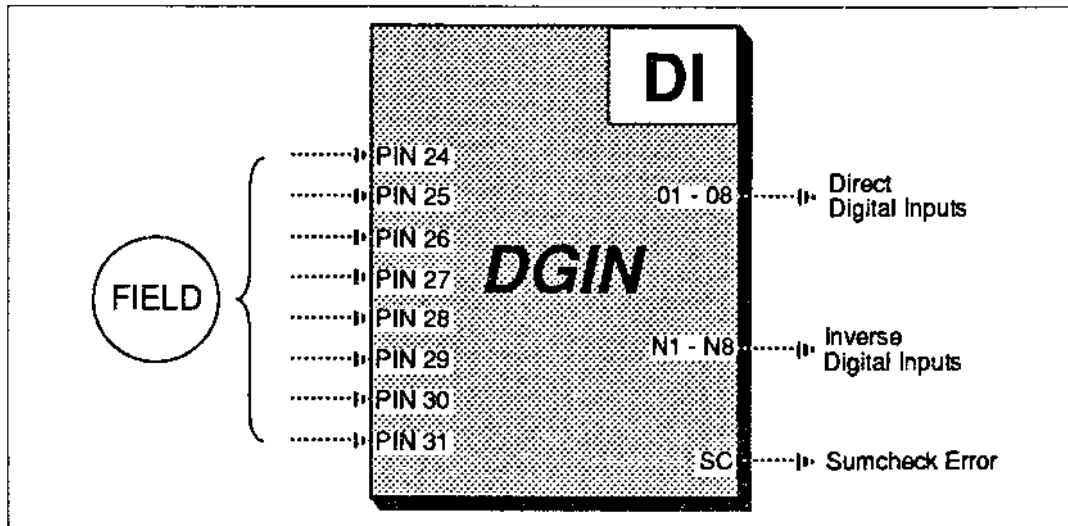

Figure 4.11 *Digital Input Block Connections*

There is only one digital input block, but it has eight individual inputs, as shown in Figure 4.11.

Inputs From the Field. Table 4.10 lists the instrument pin numbers used for the eight DGIN block field inputs; also included are the equivalent 7950 Universal Packaging System customer terminal numbers. Please see the relevant Facts Card for other sleeve equivalent terminal numbers.

Digital Input	Instrument Pin	7950 Terminal
01	24	5
02	25	6
03	26	7
04	27	8
05	28	9
06	29	10
07	30	11
08	31	12

Table 4.10 *DGIN Field Input Pin Numbers*

Outgoing Connections. The connections coming out of the block are detailed in Table 4.11.

Code	Connection	Function	Format*
01 to 08	Direct Digital Inputs	<i>Normal operation</i> (XM bit unset): sets to logic 0 for input of 0V, and logic 1 for input of 15V. <i>Inverse operation</i> (XM bit set) sets to logic 1 for input of 0V, and logic 0 for input of 15V.	0/1
N1 to N8	Inverse Digital Inputs	Inverse of corresponding Direct Digital Inputs 01 to 08	0/1
SC	Sumcheck Error	Latches to 1 on sumcheck failure	0/1

Table 4.11 *DGIN Outgoing Connections*

Block Parameters

Table 4.12 lists the DGIN parameters and the units or format in which they are expressed.

Mnemonic	Parameter	Format*
ST	Block Status	HHHH
XM	Exclusive-OR Mask	HHHH
DS	Digital Input States	HHHH

Table 4.12 *DGIN Block Parameters*

Each of these parameters is covered in more detail in the sections that follow.

*See Table 4.2 for an explanation of these formats

ST Block Status

Figure 4.12 shows the meanings of the four hexadecimal digits in the ST parameter of the Digital Input block. (The symbols used in the parameter diagram are explained in Figure 4.2.)

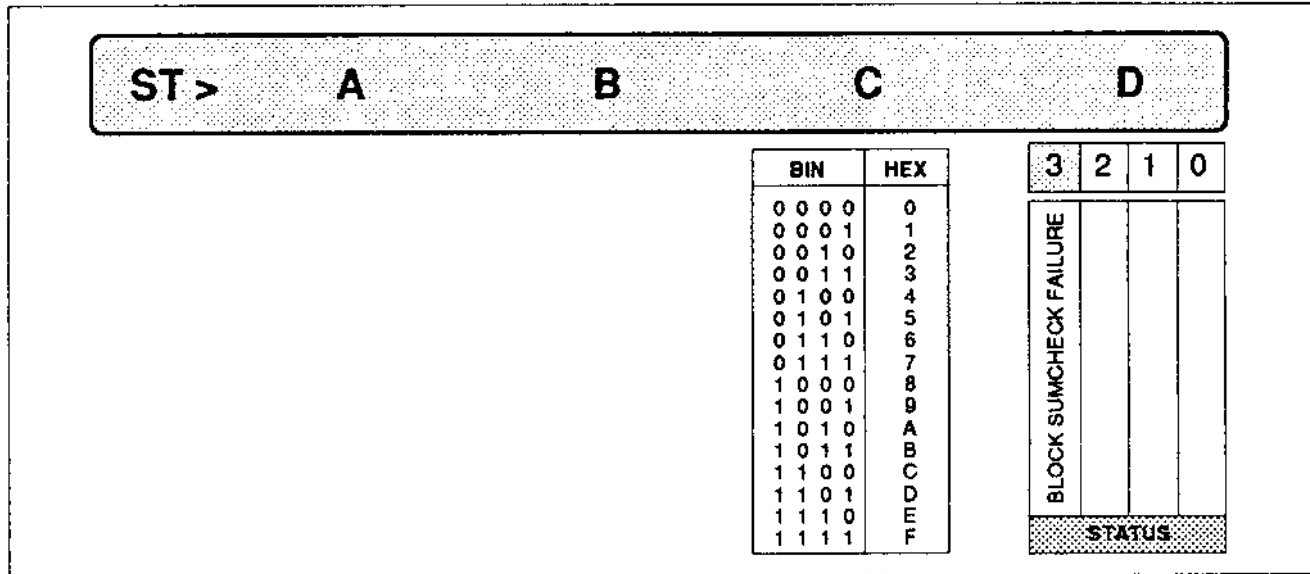

Figure 4.12 ST Parameter — Digital Input Block

Status Bit — Digit D

Bit 3 of digit D automatically latches to logic 1, and the XM parameter sets to zero, whenever the CPU detects a sumcheck failure in any of the parameters of the DGIN block. To clear this condition, re-enter any corrupted parameters, and then reset bit 3 to logic 0. Remember to reprogram XM.

XM Exclusive-OR Mask

XM lets you invert the state of any of the digital inputs, as seen by a user program, the Hand-Held Terminal or the block(s) to which the input is connected. The inversion does *not* apply to the bits of the DS parameter when accessed via the RS422 supervisory data link.

Refer to Figure 4.13 for details of the bit functions. XM is called an 'exclusive-OR' mask because if *either* an XM *or* a DS bit (but not both) is at logic 1, then the corresponding DS' bit also sets to logic 1. Otherwise, the DS' bit sets to logic 0.

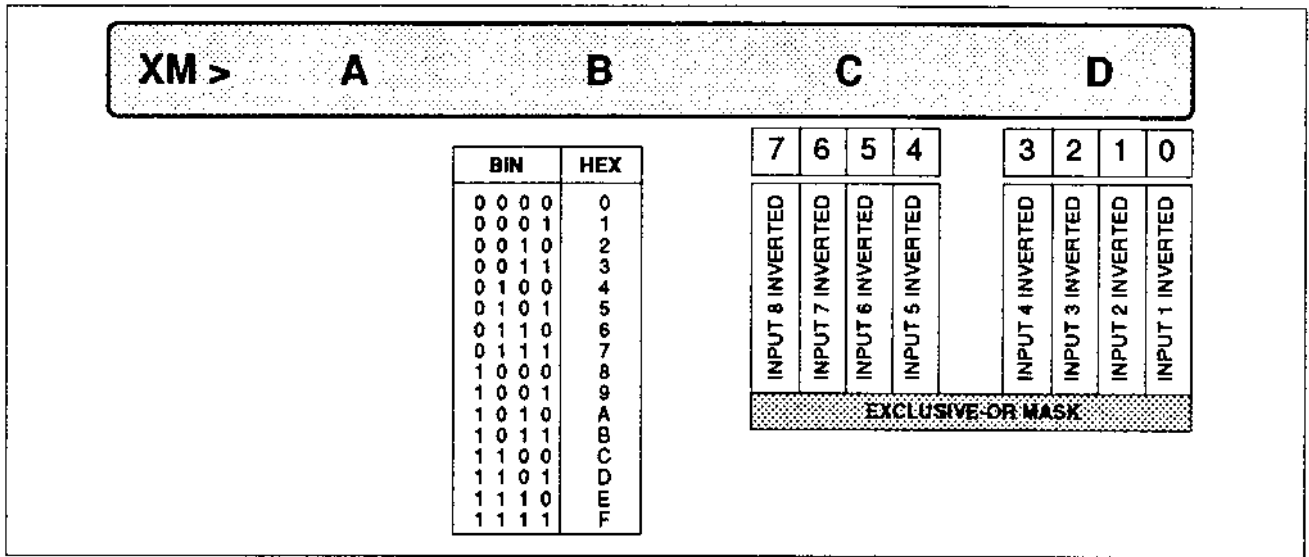

Figure 4.13 XM Parameter — Digital Input Block

DS Digital Input States

The DS parameter registers the current states of the DGIN block's 8 digital inputs. Please see Figure 4.14. (The symbols used in the diagram are explained in Figure 4.2.)

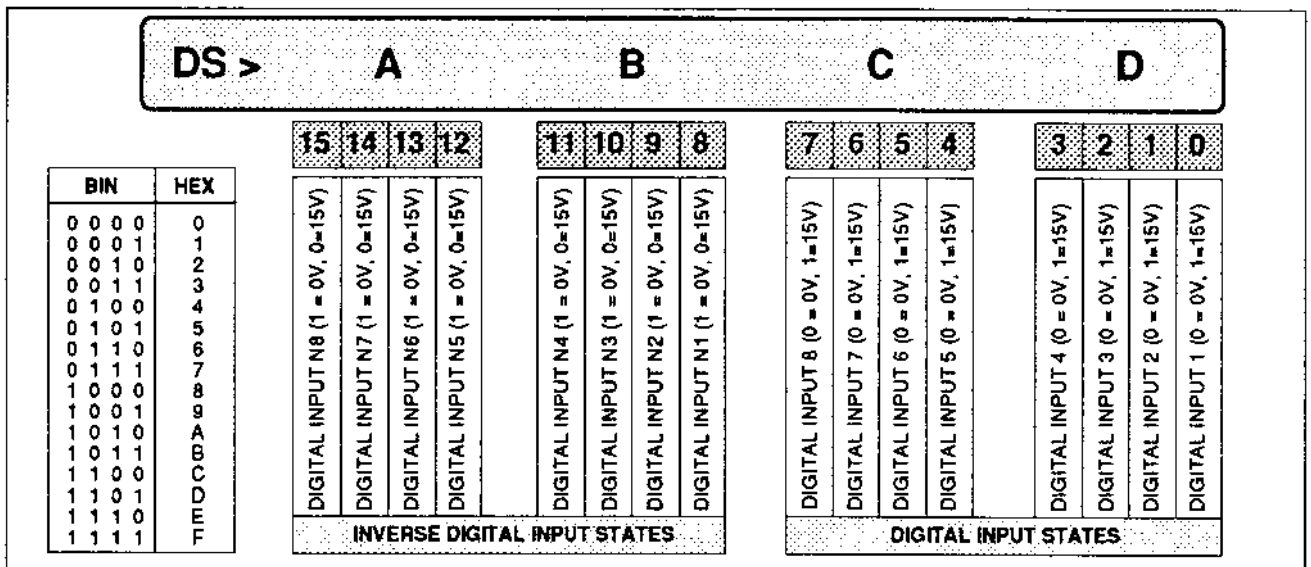

Figure 4.14 DS Parameter — Digital Input Block

NOTE. DS parameter bits have *inverted* meanings when the corresponding XM (Exclusive-OR Mask) parameter bits are set. E.g. If XM bit 7 is set to logic 1 to invert input 08, then a 15V input on pin 31 causes bit 7 of DS to go to zero instead of 1. Also, DS bit 15 (for input N8) sets to logic 1 instead of Zero.

This DS parameter bit inversion is not seen when the bits are accessed via the RS422 supervisory data link.

DGOP: DIGITAL OUTPUT BLOCK

Block Function

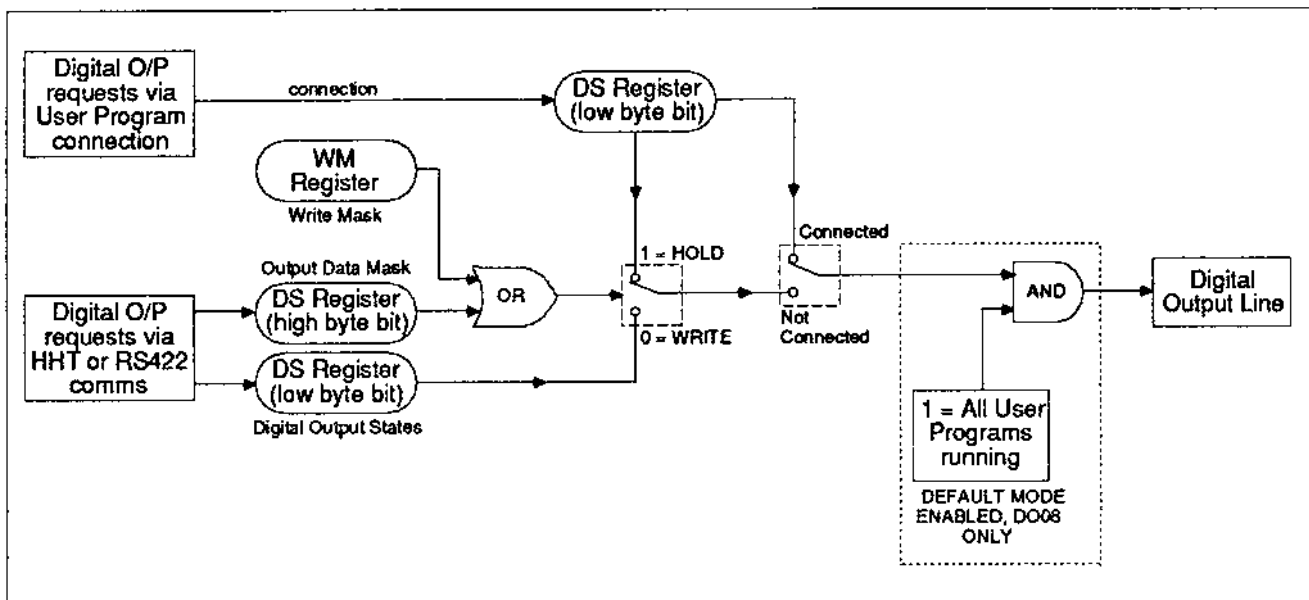

Figure 4.15 *Digital Output Block Schematic*

Please refer to Figure 4.15. The DGOP block lets you alter the logic states of the instrument's eight digital output lines.

The *low byte* of the DS parameter controls the logic state of the digital output lines. The *high byte* of DS holds individual mask bits for each corresponding digital output. These allow the states of *unmasked* digital outputs to be altered via the Hand-Held Terminal or RS422 data link, leaving the *masked* outputs unaffected. This masking action does not operate for digital outputs connected to the control strategy, as is shown in the block schematic.

Data Link Write Mask. The block schematic shows that the DS parameter can always be changed directly from a user program (control strategy), but changes via the Hand-Held Terminal or RS422 data link are controlled by the *Write Mask* parameter, WM. DS bits cannot be altered via either of the data links unless the appropriate WM bit is set to logic 0.

Block Connections

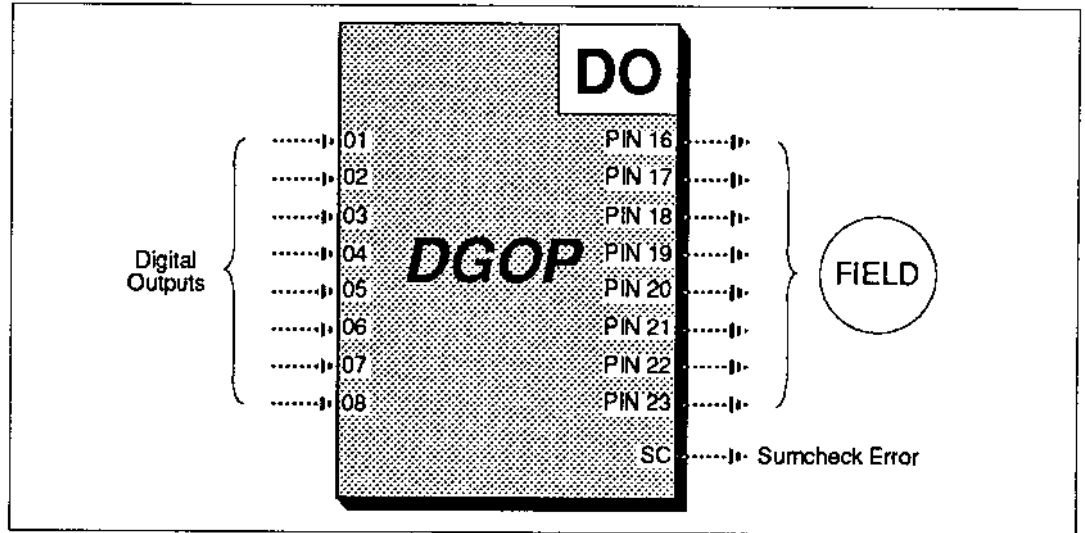

Figure 4.16 *Digital Output Block Connections*

There is only one digital output block, but it has eight individual lines, as shown in Figure 4.16.

Incoming Connections. The connections coming into the DGOP block are summarised in Table 4.13.

Code	Connection	Function	Format*
01 to 08	Digital Outputs	Logic 0 sets field output to 0V Logic 1 sets field output to 15V	0/1

Table 4.13 *DGOP Incoming Connections*

Outgoing Connections. Table 4.14 shows the outgoing connection from the DGOP block, available for connecting to another block (or blocks).

Code	Connection	Function	Format*
SC	Sumcheck Error	Latches to 1 on sumcheck failure	0/1

Table 4.14 *DGOP Outgoing Connections*

*See Table 4.2 for an explanation of these formats

Outputs to the Field. Table 4.15 lists the instrument pin numbers used for the eight DGOP block field outputs; also included are the equivalent 7950 Universal Packaging System customer terminal numbers. Please see the relevant Facts Card for other sleeve equivalent terminal numbers.

Digital Output	Instrument Pin	7950 Terminal
01	16	20
02	17	21
03	18	22
04	19	23
05	20	24
06	21	25
07	22	26
08	23	27

Table 4.15 *DGOP Field Output Pin Numbers*

NOTE. With default mode enabled and all loops running, digital output DO08 in the DGOP block holds at logic 1. If *any* loop program halts, DO08 flags this by resetting to logic zero. You can still connect a digital output to DO08 in default mode, but this output ANDs with the 'program running' flag (i.e. only if *both* are high is the DO08 output also high).

Block Parameters

Table 4.16 lists the DGOP parameters and the units or format in which they are expressed.

Mnemonic	Parameter	Format*
ST	Block Status	HHHH
WM	Write Mask	HHHH
DS	Digital Output States	HHHH
FC	Function Control Register	HHHH

Table 4.16 *DGOP Block Parameters*

Each of these parameters is covered in more detail below.

ST Block Status

The Digital Output block status parameter, ST, exactly corresponds to the Digital Input block status parameter (also called ST), which is described in the DGIN section on page 4.24. On sumcheck failure detection, the WM parameter is set to zero and will need reprogramming.

WM Write Mask

The Write Mask parameter, WM, lets you prevent the alteration of individual digital output bits in parameter DS, via the Hand-Held Terminal or RS422 data link. WM has no effect on bit changes originating from a *user program* (control strategy).

Refer to the block schematic in Figure 4.15 to see how WM works, and to Figure 4.17 for details of the bit functions.

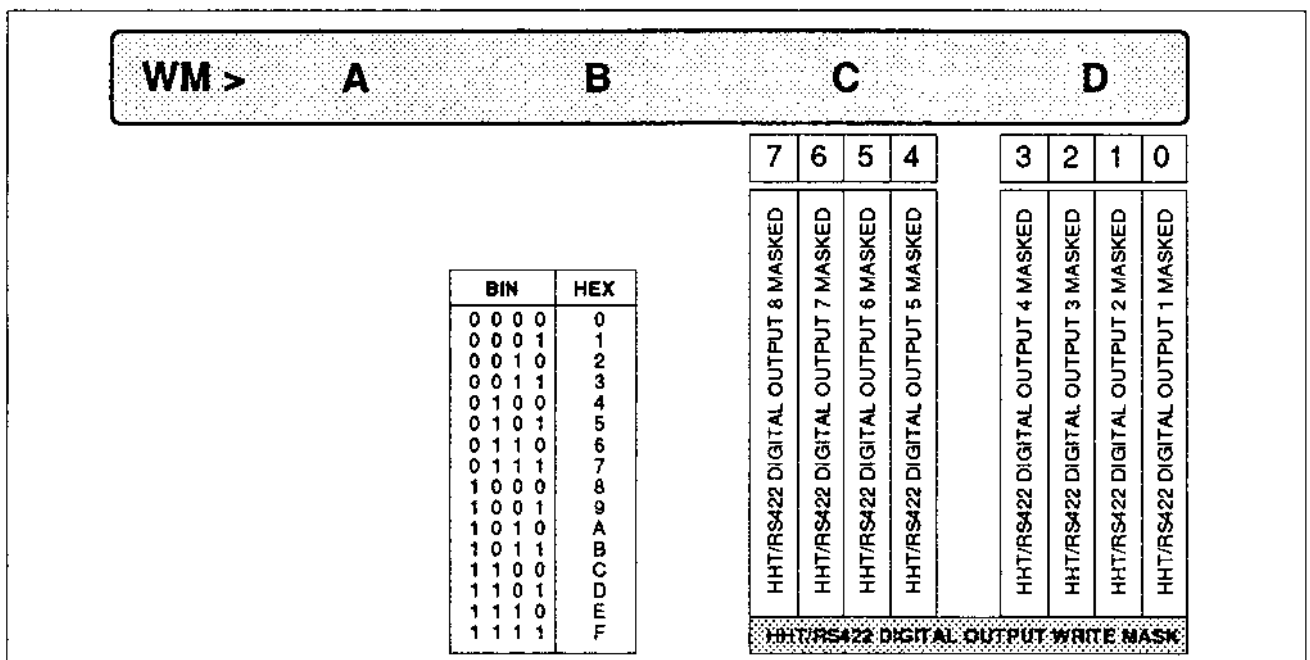

Figure 4.17 WM Parameter — Digital Output Block

DS Digital Output States

Digits C and D of the DS parameter control the logic states of the digital outputs. Write-only digits A and B hold individual mask bits for each output bit in digits C and D. Figure 4.18 shows the meanings of the four hexadecimal digits in the DS parameter.

To *enable* any of the 8 digital output bits to be changed via the Hand-Held Terminal or RS422 data link, set the appropriate mask bit to logic 0. To *prevent* a digital output bit having its state changed, set the corresponding mask bit to logic 1. This facility lets you set or clear individual outputs with a single write operation to the DS parameter without having to read its value first.

*See Table 4.2 for an explanation of these formats

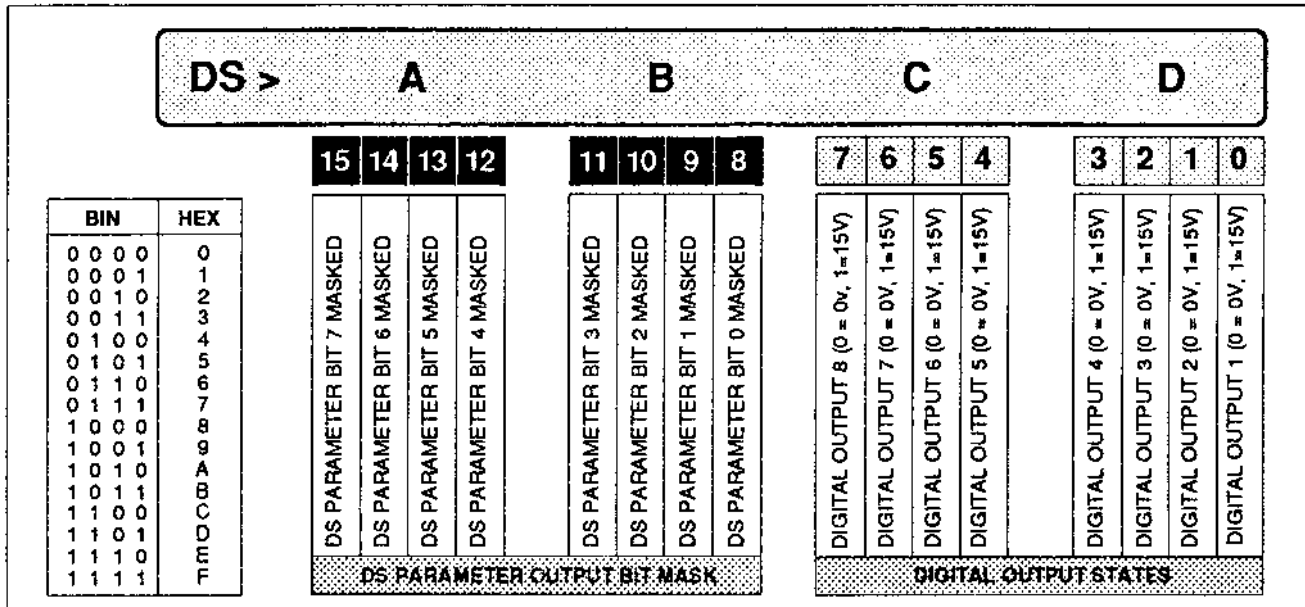

Figure 4.18 DS Parameter — Digital Output Block

To change selected digital outputs via the Hand-Held Terminal or RS422 data link, whilst leaving the others unaltered (whatever their states), only a single 4-digit word need be written to the DS parameter. Digits A and B of this word contain a logic 1 for each low byte bit needing write-protection, and a logic 0 for each low byte bit to be changed. Digits C and D contain the required states for the unmasked bits, and 'don't care' states for the rest. The DS mask bits are 'write-only', i.e. they reset to logic zero after writing to, ready for further use.

The following examples show the action of the DS parameter.

Action	Existing DS Output State	Enter DS Parameter	Resultant DS Output State*
Set DS bit 0	>0000	>0001	>0001
Inhibit DS bit 0	>0000	>0101	>0000
Set bit 7 (all others inhibited)	>0000	>7FFF	>0080

*Note that digits A and B always read back as zero.

FC Function Control Register

The FC parameter is explained on page 4.19. Please refer there for details.

MANS: MANUAL STATION BLOCK

Block Function

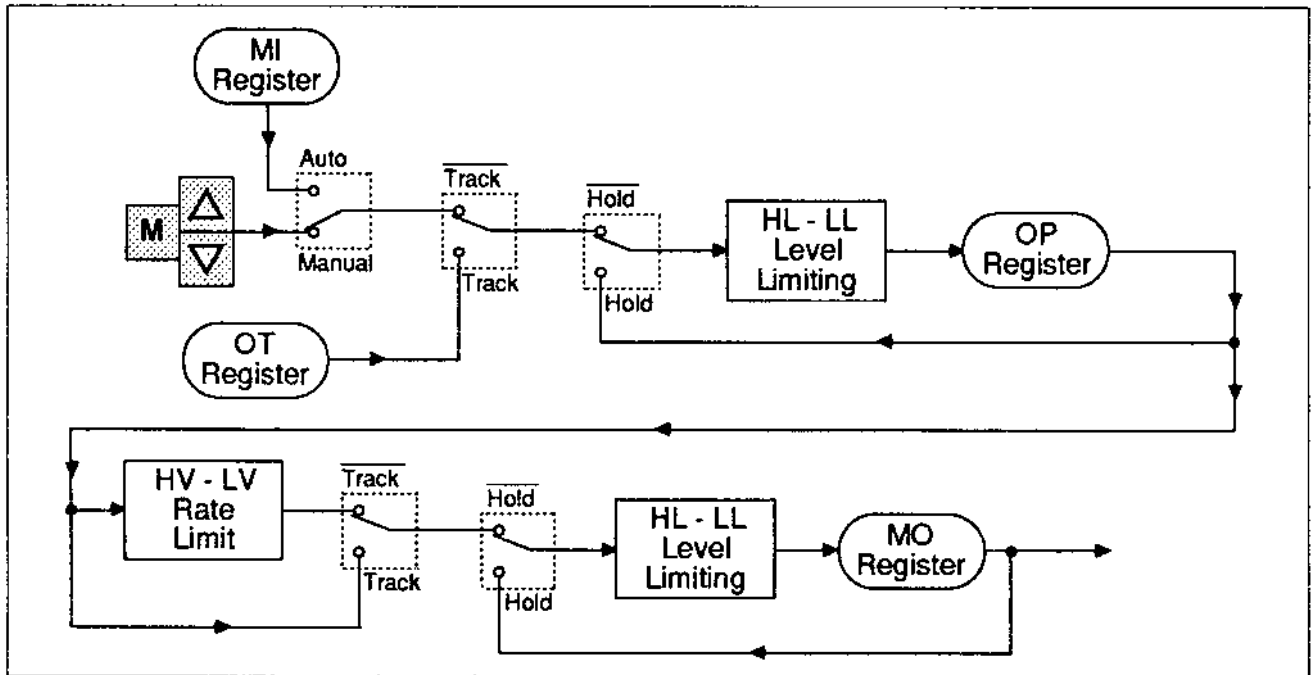

Figure 4.19 Manual Station Block Schematic

Please refer to Figure 4.19. The MANS block lets you vary a control loop output when the loop is in *manual* mode. Alternatively, you can have the output varied automatically by an associated PID block in *auto* mode, or set the output into *hold* or *track* modes.

Output Demand, OP. The OP parameter (held in the OP register) represents the demanded output level fed into the MANS block after limiting by the Output Limit parameters HL and LL. The value of OP can derive from different sources depending on the control loop operating mode:

- **TRACK mode** — OP is updated from the Track Output value held in the OT register.
- **MANUAL mode** — OP is varied by the raise/lower buttons or either of the serial data links (Hand-Held Terminal and RS422).
- **AUTO, REMOTE, or RATIO mode** — OP is updated from another function block (e.g. the output, OP, of a PID control block, held in the MI register).

Manual Station Output, MO. The MO parameter (held in the MO register) represents the resultant output value of the MANS block.

MO is updated from OP after initial limiting by the Incremental and Decremental Rate Limit parameters HV and LV (except in TRACK mode). OP is then further restricted by the Output Limit parameters HL and LL before passing to the MO register. (The MO value can be fed back to the associated PID block to facilitate output saturation detection. If MO outputs via an ANOP block, the ANOP's AO parameter can be fed back instead, as it has its own independent HL and LL limiting parameters.)

Block Connections

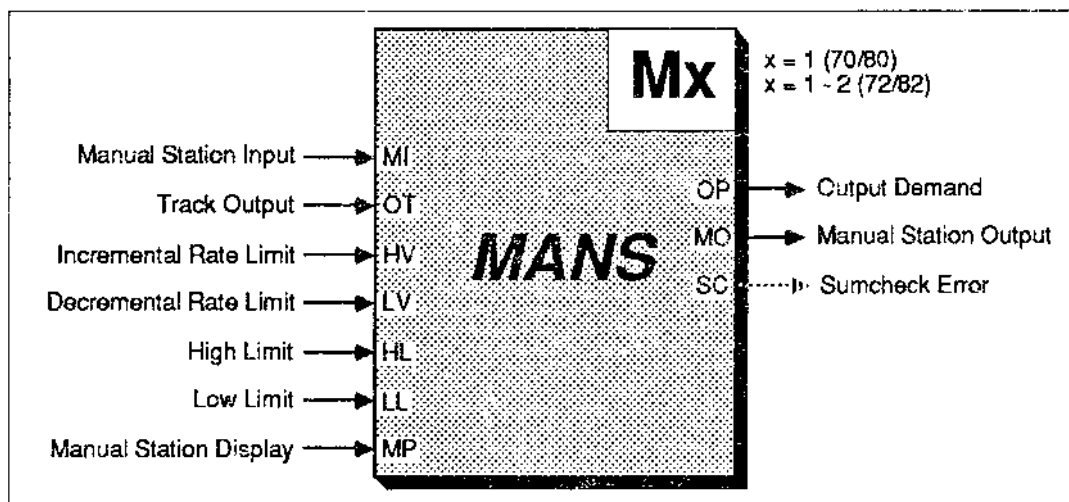

Figure 4.20 Manual Station Block Connections

Figure 4.20 represents all the MANS blocks in the instrument (one or two blocks depending on model). Each block has its own address and parameter set.

NOTE. ON/OFF Control Action. When ON/OFF action has been selected for the control block (XP set to 0), OP can have only two values: 0% or 99.99%. In TRACK mode, with ON/OFF action, OP no longer directly tracks OT but switches between 0% and 99.99% with hysteresis. As OT rises to 50.5% or over, OP switches from 0% to 99.99%. As OT falls to 49.5% or under, OP switches back to 0% output.

Incoming Connections. The connections coming into the MANS block are summarised in Table 4.17.

Code	Connection	Function	Format*
MI	Manual Station I/P	Output of a PID block (etc.) Updates OP register when control loop is in AUTO mode	FP
OT	Track Output	Updates OP register when control loop is in TRACK mode	FP
HV	Incremental Rate Limit	Limits increase rate of MO	FP
LV	Decremental Rate Limit	Limits decrease rate of MO	FP
HL	High Output Limit	Maximum value of OP and MO	FP
LL	Low Output Limit	Minimum value of OP and MO	FP
MP	Manual Station Display	Accesses horizontal bargraph	FP

Table 4.17 *MANS Incoming Connections*

Outgoing Connections. Table 4.18 summarises the outgoing connections from the MANS block, available for connecting to another block (or blocks).

Code	Connection	Function	Format*
OP	Output Demand	Demanded output level fed to MANS block, limited by HL and LL	FP
MO	Manual Station O/P	Resultant output from MANS block. Limited by HV, LV and HL, LL. (Can be fed back to PID block as FB parameter.)	FP
SC	Sumcheck Error	Latches to 1 on sumcheck failure	0/1

Table 4.18 *MANS Outgoing Connections*

*See Table 4.2 for an explanation of these formats

Block Parameters

Table 4.19 lists the MANS parameters and the units or format in which they are expressed.

Mnemonic	Parameter	Format*
ST	Block Status	HHHH
HV	Output Incremental Rate Limit	100%/s
LV	Output Decremental Rate Limit	100%/s
HL	High Output Limit	100%
LL	Low Output Limit	100%
MO	Manual Station Output	100%
OP	Output Demand	100%
OT	Output Track Value	100%
MP	Manual Station Display	100%
FC	Function Control Register	HHHH

Table 4.19 MANS Block Parameters

NOTE. MANS blocks are incorporated into XCON and RCON blocks when these are installed (at C1 or C2). You cannot then individually access an incorporated MANS block because its parameters then form part of the control block's parameter set.

ST Block Status

The MANS ST parameter has the same form and function as the Digital Input block ST parameter, described on page 4.24.

After a MANS sumcheck error, ST bit 3 latches to logic 1, and HL, LL set to 99.99 and 0 respectively. Also, the MANS output MO automatically links temporarily to a specific Analogue Output block: MANS block M1 links to ANOP block B4 (all instruments), and M2 links to B3 (6372/82). On sumcheck error, MO sets either to zero if the ANOP block to which it is linked is operating *normally*, or to 99.99% if the linked ANOP block is operating *inversely*.

After clearing the sumcheck error (by re-entering any corrupted parameters), reset bit 3 to logic 0 and reprogram HL, LL, and MO.

*See Table 4.2 for an explanation of these formats

HV & LV Output Incremental & Decremental Rate Limits

HV (Incremental Rate Limit parameter) defines in percent-per-second units the maximum rate at which the block's resultant analogue output, MO, is allowed to *increase*. Similarly, LV (the Decremental Rate Limit parameter) defines the maximum rate at which MO is allowed to *decrease*. To disable HV, LV, set both to zero. (They are bypassed in TRACK mode.)

HL & LL Output Limits

The HL (High Limit) and LL (Low Limit) parameters restrict the range (in percentage units) of both the OP and MO parameters. The block schematic in Figure 4.19 shows that they operate on OP and MO in all control loop modes, manual or auto, track or hold.

HL, the maximum value, must always be set greater than LL, the minimum value.

MO Manual Station Output

MO is the resultant output value of the Manual Station block, limited by HV, LV, and HL, LL. MO can be fed back to the associated PID control block as the FB parameter. Alternatively, if MO outputs via an ANOP block, the ANOP's AO parameter (independently HL, LL limited) can be used for feedback.

OP Output Demand

OP is the demanded output level fed into the MANS block after limiting by HL and LL. Please refer to the Block Function section above for more details.

OT Output Track Value

The OT parameter updates the value of OP when the control loop is in TRACK mode.

MP Manual Station Display

If the MP block input is left unconnected, the MP parameter simply tracks MO, the Manual Station output, and is displayed on the front panel horizontal output Bargraph 3. If instead you connect an analogue input to MP (e.g. the *measured position* signal of the element being controlled) the MP parameter and the bargraph are updated by this signal rather than MO.

Front Panel Pushbutton Responses. What you see displayed on the front panel digital readout and output bargraph (Bargraph 3) when you press the 'M', 'A', or 'R' buttons depends on whether or not the MP block input is connected to. Table 4.20 summarises the responses.

MP Input	Normal Display	Press 'M'	Press 'R' or 'A'
Connected	Dig. Readout = PV Bargraph 3 = MP	Dig. Readout = OP Bargraph 3 = OP	Dig. Readout = MP Bargraph 3 = OP
Not Connected	Dig. Readout = PV Bargraph 3 = MO*	Dig. Readout = OP Bargraph 3 = OP	Dig. Readout = MO* Bargraph 3 = OP

*MO = MP in these cases

Table 4.20 *MP Input — Front Panel Pushbutton Responses*

FC Function Control Register

The FC parameter is explained on page 4.19. Please refer there for details.

XPID: CONTROL BLOCK

Block Function

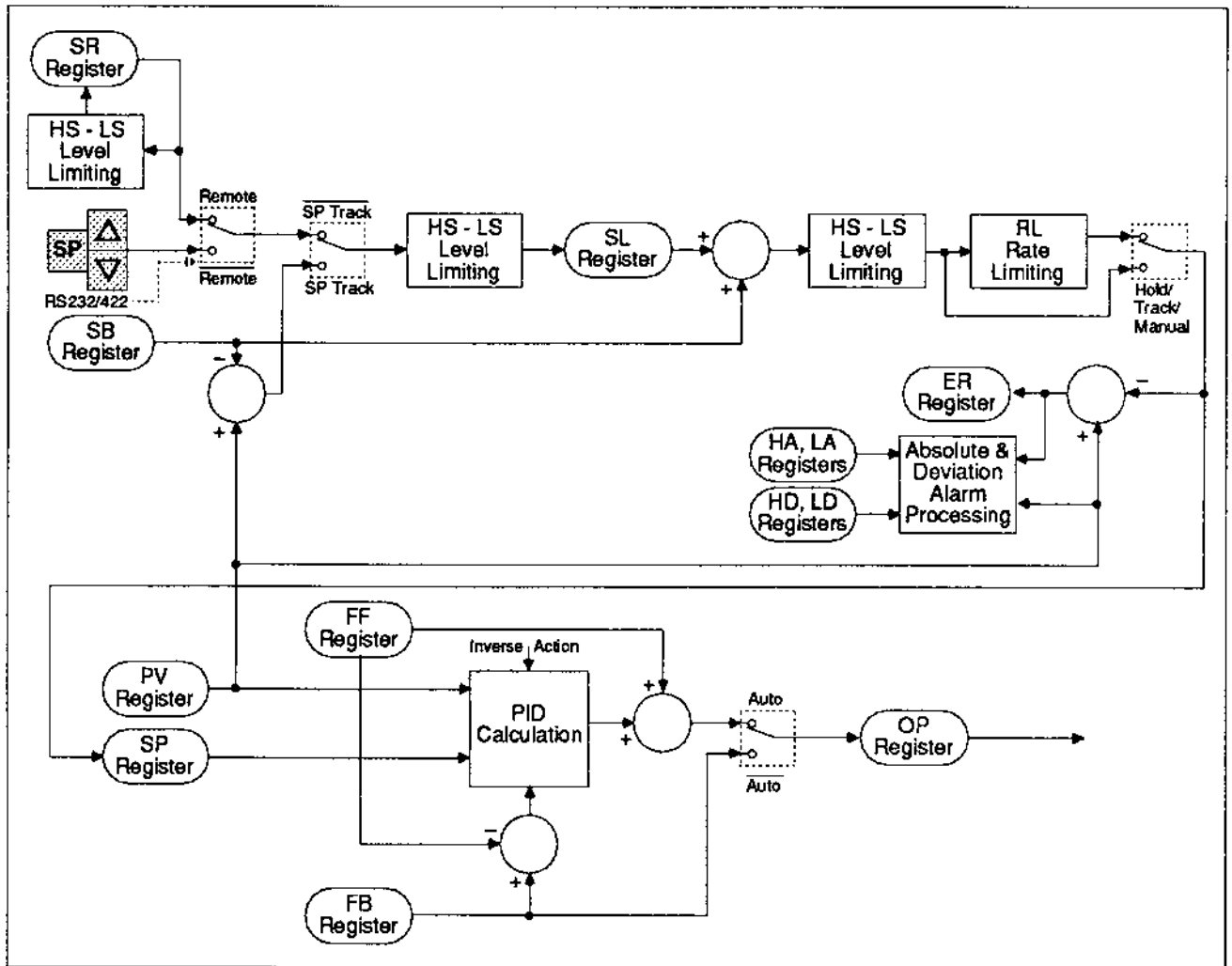

Figure 4.21 XPID Block Schematic

Please refer to Figure 4.21. The XPID block performs two basic functions. It generates a resultant internal setpoint SP (upper part of the schematic), and then uses this setpoint to apply PID control (lower part of the schematic).

NOTE. The XPID block has no built-in manual station. If you want to be able to manually adjust the block's output-control signal (OP) you should use an XCON Control block.

Local Setpoint, SL. The SL register holds this parameter, which can derive from several sources depending on the control loop operating mode:

- **MANUAL mode** — *ST bit 10 = 0 (SP Constant)*
SL is varied by the raise/lower buttons or either of the serial data links (Hand-Held Terminal and RS422).
- *ST bit 10 = 1 (SP Track)*
SL varies such that SP tracks the PV (Process Variable) input. It cannot be altered but only monitored via the front panel or serial data links.
- **AUTO mode** — SL is varied by the raise/lower buttons or either of the serial data links (Hand-Held Terminal and RS422).
- **REMOTE mode** — SL is forced to track the Remote Setpoint parameter, SR. It cannot be altered but only monitored via the front panel or serial data links.

Resultant Setpoint, SP. In all operating modes, SP is the sum of the Local Setpoint (SL) and the Setpoint Bias (SB), after limiting has been applied. Please refer to the block schematic.

Setpoint Limits, HS, LS, & Rate Limit RL. The action of the setpoint and rate limits on SL depends on the control loop operating mode:

- **AUTO or MANUAL mode** — HS and LS limit the range over which SL can be varied by the raise/lower buttons or either of the serial data links (Hand-Held Terminal and RS422). These limits are then applied again after bias has been added, to produce the Resultant Setpoint SP. Rate Limiting (RL parameter) is applied in AUTO mode, but is bypassed in MANUAL, TRACK, and HOLD modes.
- **REMOTE mode** — The SR parameter is limited by HS and LS before becoming the SL value. Rate Limiting is applied later to the biased signal.

Absolute Alarms. PV is checked for High and Low absolute alarms via the HA and LA parameters (with 0.5% hysteresis).

Deviation Alarms. A Deviation (Error) value is calculated as:

$$\text{Deviation, ER} = \text{PV} - \text{SP.}$$

ER is then checked for High and Low deviation alarms via the HD and LD parameters (with 0.5% hysteresis).

3-Term Algorithm. The Error term ER, Process Variable PV, and Setpoint SP, together with the 3-term constants, are used by the PID calculation to generate a corresponding 3-term output. Please see Chapter 7 for the mathematical details of the PID algorithm, which is based on sampling techniques.

Feedforward Term. The Feedforward term offset, FF, is apparent at zero error under proportional-only control action with the integral term disabled (TI set to zero). FF allows the output to respond to both positive and negative errors, so that the operating point about which stability occurs may be adjusted. It also allows feedforward control strategies to influence the output directly.

Feedback Parameter, FB: Integral Desaturation. You usually link the PID output, OP, to a Manual Station block (MANS) so that output or rate limits can be applied. You can then connect the resultant *limited* output MO (or, if the output is via an ANOP block, the AO parameter) back to the XPID block via the Feedback parameter, FB.

The PID calculation compares FB (less any FF offset) with OP (also before FF has been added) to detect high or low output limiting, and then implements any required integral desaturation. Please refer to TCS publication *System 6000 Controller Applications* for details on integral desaturation.

Inverse 3-Term Action. Bit 7 of the 3T parameter selects whether the output of the XPID block, OP, is in the Direct (Normal) or Inverse operating mode. Please refer to the Block Parameters section for more detail.

Integral Balance. Bit 6 of the 3T parameter is used to force the CPU to perform an Integral Balance (see *System 6000 Controller Applications*) next time the XPID block is scheduled. Integral balance is *automatically* done at power-up and whenever the loop mode is changed to Auto, Auto Fall-back, or Remote Auto, or whenever the XP or SL value is changed.

Output Track when not in AUTO. OP tracks FB whenever the control loop is not in AUTO, e.g. when in MANUAL. This prevents OP exceeding a limit and makes the return to AUTO operating mode 'bumpless'.

Block Connections

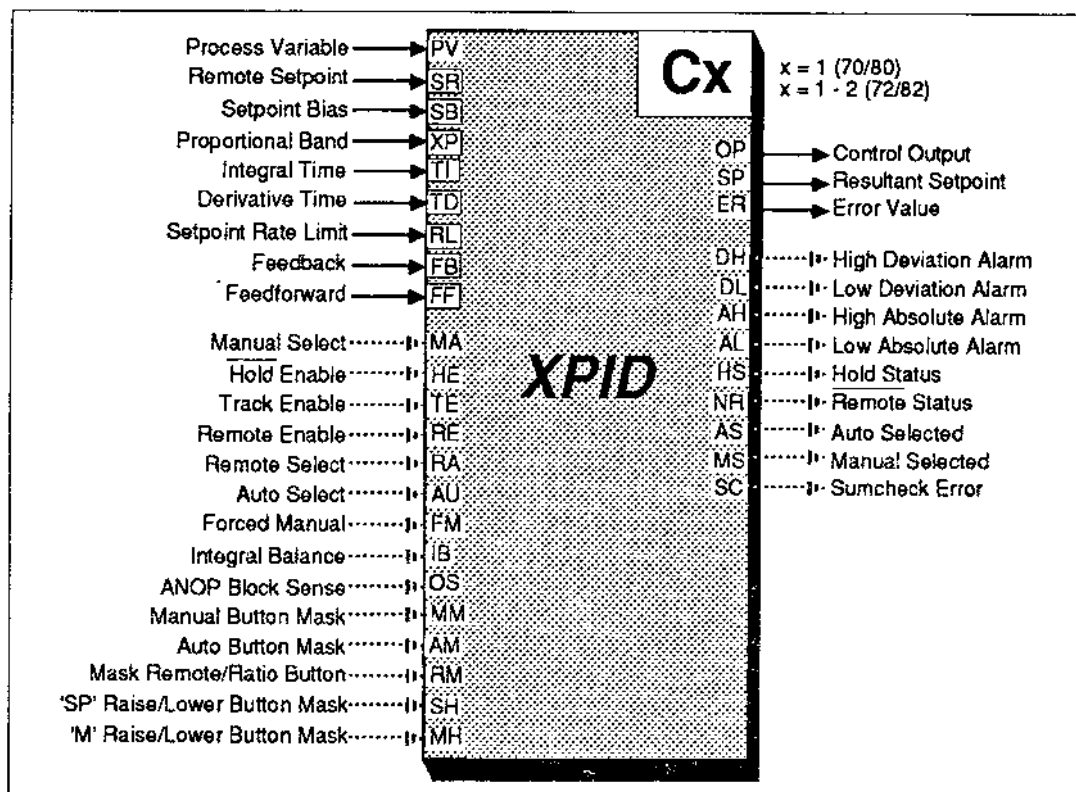

Figure 4.22 XPID Block Connections

Figure 4.22 represents all the XPID blocks in the instrument (one or two blocks depending on model). Each block has its own parameter set and can be installed at its own address. (*Control Block Addresses:* see Notes 1 and 2 on page 4.2.)

Incoming Connections. The connections coming into the XPID block are summarised in Table 4.21.

Code	Connection	Function	Format*
PV	Process Variable	Scaled by PH, PL	FP
SR	Remote Setpoint	Value before bias is added. Limited by HS, LS	FP
SB	Setpoint Bias	Bias added to SL to form SP	FP
XP	Proportional Band	Reciprocal of PID loop overall gain, expressed as percentage	FP
TI	Integral Time	Time constant (TI) used in PID calc.	FP
TD	Derivative Time	Time constant (TD) used in PID calc.	FP
RL	Setpoint Rate Limit	Maximum rate at which SP can change	FP

FB	Feedback	PID output OP fed back to PID calculation after limiting via MANS (or via ANOP block)	FP
FF	Feedforward	Bias added to OP	FP
MA	Manual Select	Logic 1 selects MANUAL mode	0/1
HE	Hold Enable	Logic 0 enables HOLD mode	0/1
TE	Track Enable	Logic 1 enables TRACK mode	0/1
RE	Remote Enable	Logic 1 enables REMOTE mode	0/1
RA	Remote Select	Logic 1 selects REMOTE mode	0/1
AU	Auto Select	Logic 1 selects AUTO mode	0/1
FM	Forced Manual	Logic 1 selects FORCED MANUAL mode	0/1
IB	Integral Balance	Rising edge triggers integral balance	0/1
OS	ANOP Block Sense	Logic 0 signifies direct O/P set Logic 1 signifies inverse O/P set (Sets ES parameter bit 4)	0/1
MM	Manual Button Mask	Logic 1 disables 'M' button	0/1
AM	Auto Button Mask	Logic 1 disables 'A' button	0/1
RM	Remote/Ratio Button Mask	Logic 1 disables 'R' button	0/1
SH	'SP' Raise/Lower Button Mask	Logic 1 disables 'SP' Δ / ∇ Buttons	0/1
MH	'M' Raise/Lower Button Mask	Logic 1 disables 'M' Δ / ∇ Buttons	0/1

Table 4.21 XPID Incoming Connections

NOTE. PV is the only input that *must* be connected to another block for its data source. You can update other inputs via connections or via the Hand-Held Terminal or RS422 data link. (Figure 4.22 shows this by 'boxing-in' the optional connections.) For the control block to function correctly, however, FB (Feedback) should be connected. Also, if FM (Forced Manual) is unconnected the program starts up in FORCED MANUAL mode. As a fail-safe measure FM should be wired so that FORCED MANUAL takes over whenever a sumcheck error or other significant failure occurs. Connect, for example, the GENP block's common block sumcheck error output (CS), OR'd with open-circuit flags (OC or O3) from the ANIN block supplying PV.

NOTE. When *default mode* is not in use, the OS (Output Sense) output of the ANOP block must be connected to the OS input of the control block connected to its AO input. If this is not done the operation of fail-safe measures may be undefined.

*See Table 4.2 for an explanation of these formats

Outgoing Connections. Table 4.22 summarises the outgoing connections from the XPID block, available for connecting to another block (or blocks).

Code	Connection	Function	Format*
OP	Control Output	PID output, including biasing	FP
SP	Resultant Setpoint	Local Setpoint value (SL) after biasing and limiting	FP
ER	Error Value	PV – SP	FP
DH	High Deviation Alarm	Sets to 1 if PV–SP > HD	0/1
DL	Low Deviation Alarm	Sets to 1 if SP–PV > LD	0/1
AH	High Absolute Alarm	Sets to 1 if PV > HA	0/1
AL	Low Absolute Alarm	Sets to 1 if PV < LA	0/1
HS	Hold Status	Sets to 1 if HOLD mode active	0/1
NR	Remote Status	Sets to 0 if REMOTE mode active, 1 if not active	0/1
AS	Auto Selected	Sets to 1 if AUTO mode selected	0/1
MS	Manual Selected	Sets to 1 if MANUAL mode selected	0/1
SC	Sumcheck Error	Latches to 1 on sumcheck failure	0/1

Table 4.22 XPID Outgoing Connections

Block Parameters

Table 4.23 lists the XPID parameters and the units or format in which they are expressed.

Mnemonic	Parameter	Format*
ST	Block Status	HHHH
PH	Setpoint & PV High Range	±Eng.
PL	Setpoint & PV Low Range	±Eng.
HS	Setpoint High Limit	±Eng.
LS	Setpoint Low Limit	±Eng.
HA	High Absolute PV Alarm	±Eng.
LA	Low Absolute PV Alarm	±Eng.
HD	High Deviation Alarm	Eng.
LD	Low Deviation Alarm	Eng.

SL	Local Setpoint	±Eng.
SR	Remote Setpoint	±Eng.
SB	Setpoint Bias	±Eng.
ER	Error (PV – SP)	±Eng.
RL	Setpoint Rate Limit	±Eng./s
3T	PID Status	HHHH
XP	Proportional Band Constant	1000%
TI	Integral Time Constant	100
TD	Derivative Time Constant	100
TS	Algorithm Sampling Time	100
FF	Feedforward Term	±100%
FB	Feedback Term	100%
OP	PID Control Output	100%
SP	Resultant Internal Setpoint	±Eng.
PV	Process Variable	±Eng.
ES	Enable Status	HHHH
MD	Loop Operating Mode	HHHH
SM	Front Panel Pushbutton Mask	HHHH
FC	Function Control Register	HHHH

Table 4.23 *XPID Block Parameters*

Each of these parameters is covered in more detail in the sections that follow.

ST Block Status

Figure 4.23 shows the meanings of the hexadecimal digits in the ST parameter of the XPID Control block. (The symbols used in the parameter diagram are explained in Figure 4.2.)

Decimal Point Selection — Digit A

Digit A selects the decimal point position, as displayed on the Hand-Held Terminal, for all the parameters in the XPID block that are in engineering units or derived from engineering units (see Table 4.23).

Setpoint Operating Mode — Digit B

Digit B selects features of the setpoint operation.

- **Integral Balance Disable — Bit 11.** Set bit 11 to logic 1 to disable the balancing of the integral term on local setpoint (SL parameter) changes.

*See Table 4.2 for an explanation of these formats

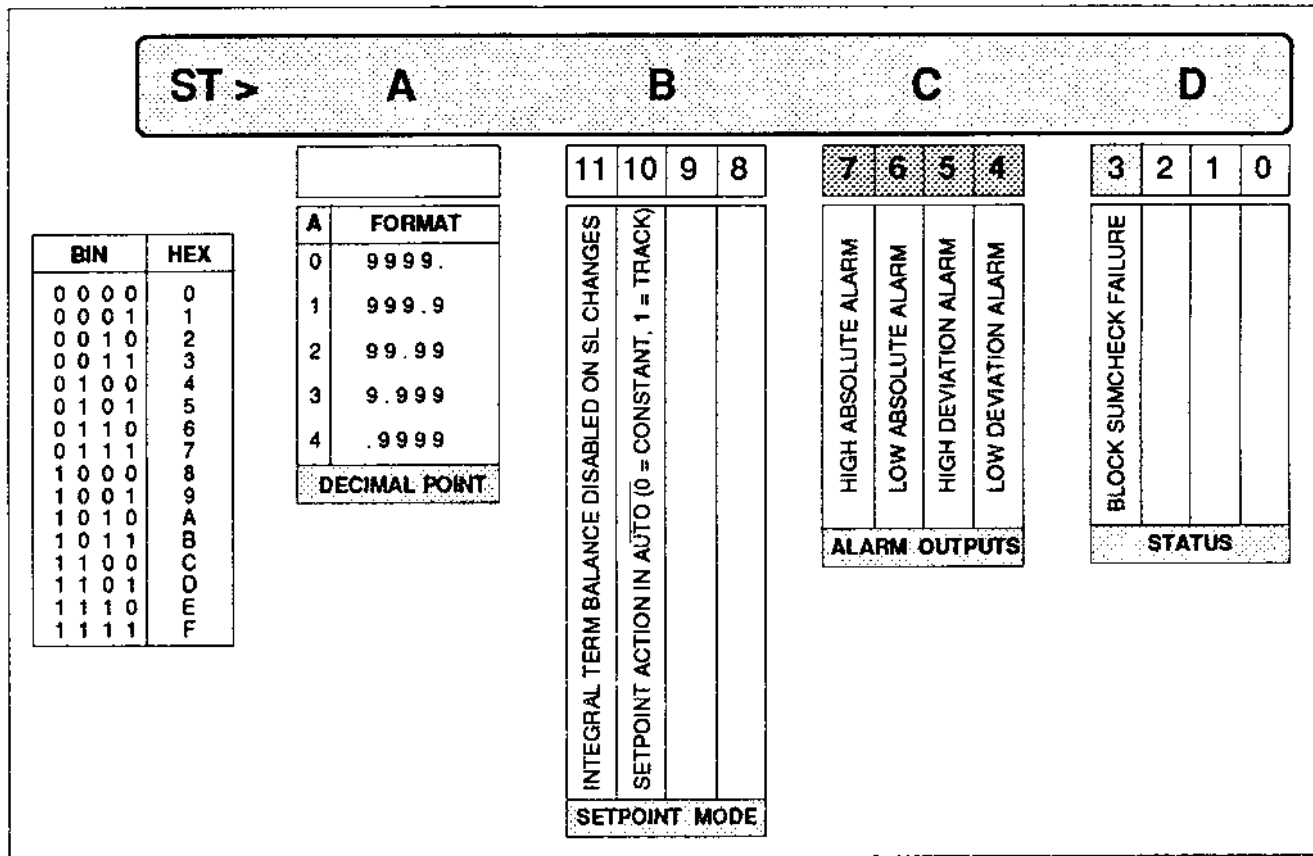

Figure 4.23 ST Parameter — XPID Control Block

- Setpoint Action — Bit 10.** This bit determines what happens to the local setpoint value (SL) when the control loop is not in AUTO, REMOTE, or FORCED AUTO mode. With bit 10 set to 0, SL remains constant. With bit 10 set to 1, SL varies such that SP tracks the PV (Process Variable) input, i.e. $SL = PV - SB$, ensuring a bumpless changeover on return to an automatic mode.

Alarm Outputs — Digit C

The four bits of digit C show when the process variable (PV) has exceeded the absolute or deviation alarm limits programmed by the HA, LA, and HD, LD parameters respectively. The bits set to logic 1 on alarm.

Status Bit — Digit D

Bit 3 of digit D automatically latches to logic 1 whenever the CPU detects a sumcheck failure in any of the parameters of the XPID block. To clear this condition, re-enter any corrupted parameters, and then reset bit 3 to logic 0.

PH & PL Setpoint & Process Variable Ranging

PH (Process High range) and PL (Process Low range) define in engineering units the span of both setpoint and process variable. PH must be greater than PL.

NOTE. If you change PH and/or PL values the instrument automatically changes the values of the HS, LS, HA, LA, HD, and LD parameters. These automatic changes keep all span *ratios* and relative span *positions* constant before and after your PH, PL changes.

The process exactly corresponds to what happens to HL and LL in the ANOP block, detailed on page 4.19.

HS & LS Setpoint Limits

HS (High Setpoint limit) and LS (Low Setpoint limit) define in engineering units the range over which the resultant setpoint SP is allowed to vary. Exactly how HS and LS affect SP depends on the *control loop operating mode*, as described in the 'Block Function' section (page 4.37).

HS and LS have the same range (i.e. PH to PL) and decimal point position as the setpoint, and HS must exceed LS. Setting HS equal to LS locks SL and SP to this value, preventing them from being altered by any means. HS and LS are affected by changes to PH and PL; see the Note to the section on PH and PL above.

HA & LA Absolute Alarm Limits

The HA and LA parameters set the limits, in engineering units, outside which the PV will generate High or Low Absolute alarms, respectively. HA and LA have the same range (i.e. PH to PL) and decimal point position as the setpoint.

When alarms are generated, the process variable bargraph (6380/2 instruments) or the deviation bargraph (6370/2) flashes, and the appropriate bit of digit C in the ST parameter sets to logic 1. You can disable absolute alarms by setting HA equal to PH, and LA equal to PL.

Alarm conditions are *triggered* when PV exceeds either limit, HA or LA. However, built-in hysteresis causes the alarm condition to *clear* only when PV has returned to 0.5% inside either limit. HA and LA are affected by changes to PH and PL; see the Note to the section on PH and PL above.

HD & LD Deviation Alarm Limits

The HD and LD parameters set the limits, in engineering units, outside which the deviation parameter ER (PV-SP) will generate High or Low Deviation alarms, respectively. A high alarm condition occurs if the *positive* deviation (PV-SP) exceeds HD. A low alarm condition occurs if the *negative* deviation (SP-PV) exceeds LD. Hysteresis of 0.5% is applied inside the limits. When alarms are generated, the process variable bargraph (6380/2 instruments) or the deviation bargraph (6370/2) flashes, and the appropriate bit of digit C in the ST parameter sets to logic 1.

HD and LD have the same decimal point position as the setpoint, and must be positive numbers which do not exceed the setpoint span PL to PH. HD may equal, be greater or smaller than, LD. You can disable deviation alarms by setting both HD and LD equal to the setpoint span PL to PH. HD and LD are affected by changes to PH and PL; see the Note to the section on PH and PL above.

SL Local Setpoint

SL defines, in engineering units, the internal setpoint before bias is applied. Its decimal point position is the same as for PV (set by the ST parameter).

SL can derive from several sources depending on the control loop operating mode, as described in the 'Block Function' section on page 4.37. In all cases SL is kept within the range defined by the HS and LS parameters.

SR Remote Setpoint

SR defines, in engineering units, the remote setpoint value before bias is applied. Its decimal point position is the same as for SL (set by the ST parameter).

SR can derive from a user calculation, the output of another functional block (e.g. ANIN), the Hand-Held Terminal input, or the RS422 data link. Whatever its source, SR is kept within the range defined by the HS and LS parameters.

SB Setpoint Bias

SB defines, in engineering units, the value of bias added to the local setpoint SL on its way to becoming the resultant internal setpoint SP. Its decimal point position is the same as for SL (set by the ST parameter). The XPID block schematic (Figure 4.21) shows how limits are applied to SL+SB to form the final SP value.

ER Error Value

The ER parameter equals $PV - SP$, and so is in engineering units. Its range is (PH-LS) to (PL-HS), and its decimal point position is set by the ST parameter.

RL Setpoint Rate Limit

The RL parameter defines the maximum rate, in engineering units per second, at which the resultant internal setpoint SP can change. A zero value for RL disables rate limit.

The block schematic in Figure 4.21 shows the point at which this limiting action is applied.

3T PID Status

Figure 4.24 shows the meanings of the hexadecimal digits in the 3T parameter of the XPID Control block. (The symbols used in the parameter diagram are explained in Figure 4.2.)

Integral Balance Input Status — Digit A

Read-only bit 14 follows the state of the IB block digital input (Perform Integral Balance). Logic 1 means a high IB input, and logic 0 means a low input.

Whenever IB and bit 14 go high, the rising edge triggers bit 6 of the 3T parameter to go high as well. This causes an integral balance to be performed, after which bit 6 automatically resets to logic 0. (Bit 14 remains at the same state as input IB.) You can also initiate an integral balance by writing to bit 6 independently of IB and bit 14.

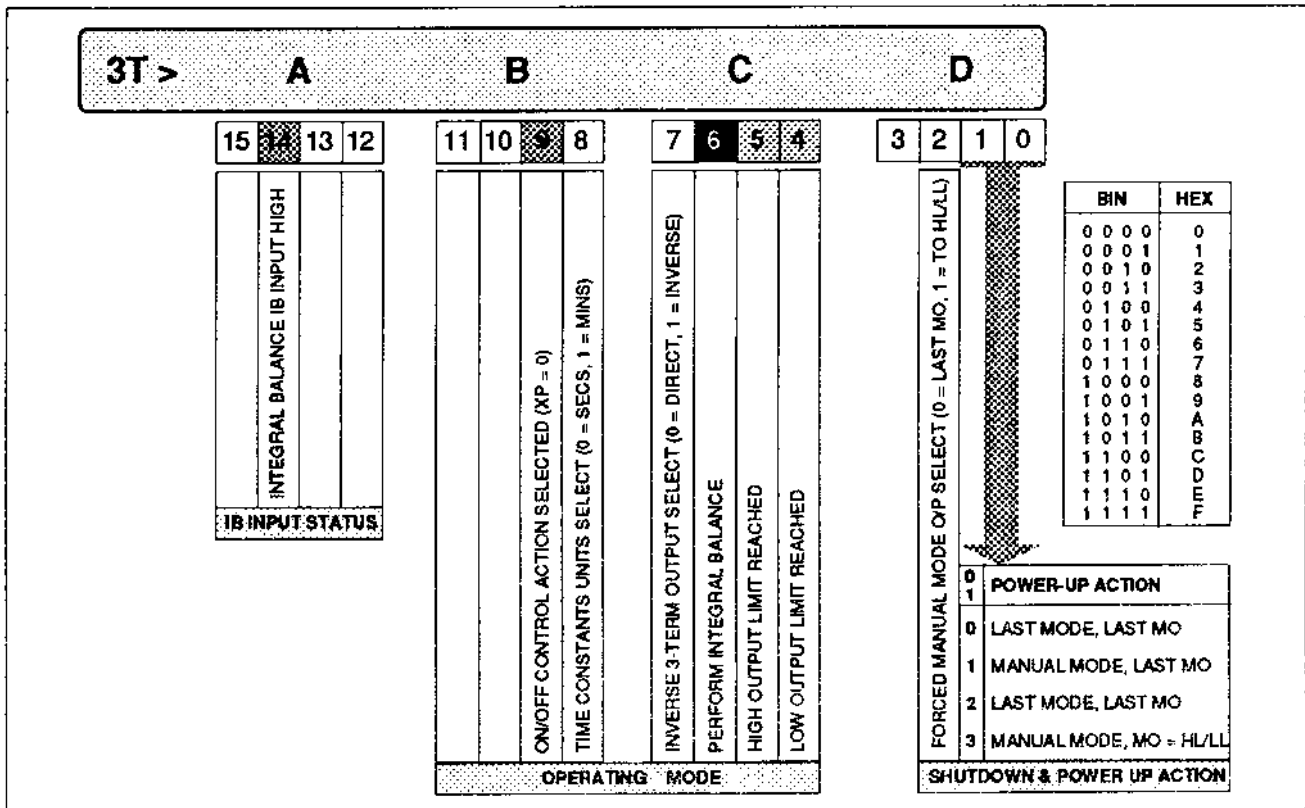

Figure 4.24 3T Parameter — XPID Control Block

Time Constants Units — Digit B

Read-only bit 9 sets to logic 1 if ON/OFF control action has been selected (by giving parameter XP a value of zero). Non-zero XP values set bit 9 to logic zero.

Bit 8 selects whether the 3-term time constants used in the PID calculation (TI, TD) are expressed in *seconds* or *minutes*.

PID Operation & Status — Digit C

- **Inverse 3-Term Output — Bit 7.** This bit determines whether the output of the XPID block (OP) is *direct* or *inverse*, as defined here.

In direct mode, OP *increases* to counteract a process variable that is falling below the setpoint. An example of direct mode operation is increasing the heat input (OP) to an oven in response to falling temperature (PV).

In inverse mode the reverse occurs: OP *decreases* to counteract a decreasing process variable. An example of inverse mode operation is decreasing the opening of a drain valve (OP) in response to falling tank level (PV).

NOTE. The instrument's output bargraph and digital readout always indicate the actual output percentage whatever the state of bit 7.

- **Integral Balance — Bit 6.** Setting bit 6 to logic 1 forces the CPU to perform an integral balance next time the XPID block is scheduled. After this, bit 6 automatically resets to logic 0. Integral balance is *automatically* done at power-up and whenever the loop mode is changed to Auto, Auto Fall-back, or Remote Auto, or whenever the XP or SL value is changed.

- **Output Limited — Bits 5 & 4.** These bits indicate when the PID output (OP) has reached an output limit.

Limits are detected by comparing OP with the feed-back value FB (both less any FF offset). FB is an absolute- and rate-limited version of OP, and they are normally equal. If OP exceeds FB a high output limit has been reached; if OP is less than FB a low output limit has been reached.

Shutdown & Power-Up Action — Digit D

- **Shutdown Output Select — Bit 2.** Bit 2 selects what happens to the controller output MO (via a Manual Station) when the block goes into Forced Manual mode (i.e. shuts down) for any reason.

With bit 2 at logic 0 the output MO simply stays at its last value on shutdown. With bit 2 at logic 1 MO updates with a 'fail-safe' value. This value will be either the Low Output Limit (LL), if the relevant Analogue Output block is using *normal* output sense, or the High Output Limit (HL), if the ANOP block is using *inverse* output sense.

If the *default mode* of controller operation has been disabled (switch 1 of switchbank 3 set to OFF) the ANOP output sense in use should be input to the control block via its OS digital input connection. This sets bit 4 of the ES parameter.

If default mode has been enabled (switch 1 of switchbank 3 set to ON), then the ANOP output sense referred to by the control block at shutdown is the one for the default ANOP; i.e. B4 for M1, and B3 for M2. In this case you should leave input OS unconnected.

- **Power-up Action Select — Bits 1, 0.** These bits select the state of the control block when the instrument powers up. Table 4.24 explains their action.

3T Bits		Hex	Power-Up Mode	Power-Up Output
1	0			
0	0	0	As last mode	MO held at last value for 3 secs, then over to normal control
0	1	1	MANUAL Mode	MO held at last value for 3 secs, then over to normal control
1	0	2	As last mode	MO held at last value for 3 secs, then over to normal control
1	1	3	MANUAL Mode	<p><i>Default Mode enabled:</i> MO set immediately to High Output Limit (HL) or Low Output Limit (LL), according to the relevant default ANOP block Output Sense*</p> <p><i>Default Mode disabled:</i> MO held at last value for 3 secs, then set to High Output Limit (HL) or Low Output Limit (LL), according to the relevant ANOP block Output Sense*</p>

*See under previous paragraph, *Shutdown Output Select — Bit 2*

Table 4.24 3T Parameter Bits 1 & 0 Power-Up Action

XP Proportional Band Constant

The XP parameter defines the overall gain of the XPID control block. XP and gain are related by:

$$\text{Gain} = 100/\text{XP}$$

So, for example, an XP value of 100 gives unity gain. An XP value of 0.1 (the practical minimum value) gives the maximum gain of 1000.

NOTE. Setting XP to zero causes the control block to operate in 'ON/OFF' action. That is, the output can have only two values, 0% or 99.99%, according to whether the error (ER = PV - SP) is positive or negative. When XP = 0, the TI parameter changes its function and defines the *deadband*, as a percentage of the PV span (PH - PL). As ER falls, the output switches over when ER equals -TI%. As ER rises, the output switches over when ER reaches zero. With XP set to 0, the TD parameter is disabled.

TI & TD Integral & Derivative Time Constants

TI and TD define the values of the integral and derivative time constants, respectively, used in the 3-term algorithm to calculate the XPID block output OP. (The algorithm is detailed in Chapter 7.)

TS Algorithm Sampling Period

Once every TS time period, the PID algorithm samples PV and SP and computes a new OP value.

The value of the TS parameter, which is read-only, is determined by the instrument itself and depends on time constant values (TI and TD) and whether they are in seconds or minutes.

- **Seconds Mode — 3T bit 8 set to logic 0.** A trial value of TS is first computed as $TI/512$ seconds (or $TD/512$ if TD is larger). If less than 0.1s (100ms) the trial value is adjusted to this minimum allowable TS value. The trial value is then compared with the repeat time of the relevant User Task (L1 or L2, i.e. 'Ln'). If the trial $TS \leq Ln$, TS is made equal to Ln (it can never be less). If the trial $TS > Ln$, then TS is set to the next higher multiple of Ln.
- **Minutes Mode — 3T bit 8 set to logic 1.** A trial value of TS is first computed as $TI/512$ minutes (or $TD/512$ if TD is larger). If less than 0.01 minutes the trial value is adjusted to this minimum allowable TS value. The trial value is then compared with the repeat time of the relevant User Task (L1 or L2, i.e. 'Ln'). If the trial $TS \leq Ln$, TS is made equal to Ln (it can never be less). If the trial $TS > Ln$, then TS is set to the next higher multiple of Ln.

FF Feedforward Term

The FF parameter effectively defines the bias value added to the output of the PID calculation before it becomes the parameter OP. Setting FF to, say, 50% allows *negative* control outputs to be represented as OP falling below 50%.

FB Feedback Term

You usually link the PID output, OP, to a Manual Station block for output or rate limits to be applied. You can then connect the resultant *limited* output MO (or, if the output is via an ANOP block, the AO parameter) back to the XPID block via the Feedback parameter, FB.

The PID calculation compares FB with OP (both less any FF offset) to detect high or low output limiting, and then implements any required integral desaturation.

OP PID Control Output

The OP parameter is the output value of the 3-term PID control algorithm after feedforward bias has been added, expressed as a percentage of the full-scale operating range (0 to 99.99%).

OP is not limited within the XPID block itself. Instead, the feedback term FB is used to find if limits have been reached, and bits 4 and 5 of the 3T parameter are set accordingly.

SP Resultant Internal Setpoint

SP defines, in engineering units, the resultant internal setpoint used in the PID calculation. The block schematic in Figure 4.21 shows how the local setpoint SL is biased and limited to form SP. Its decimal point position is the same as for SL (set by the ST parameter).

PV Process Variable

PV defines, in engineering units, the value of the process variable signal used in the PID calculation. The block schematic in Figure 4.21 shows how the local setpoint SL can be made to track PV.

PV is ranged by the setpoint and process variable ranging parameters PH and PL.

ES Enable Status

Figure 4.25 shows the meanings of the hexadecimal digits in the ES parameter of the XPID Control block. (The symbols used in the parameter diagram are explained in Figure 4.2.)

Individual Bit Masks — Digits A & B

Setting any of the bits of digits A and B to logic 1 masks the corresponding bits of digits C and D from changes via the Hand-Held Terminal or RS422 data link.

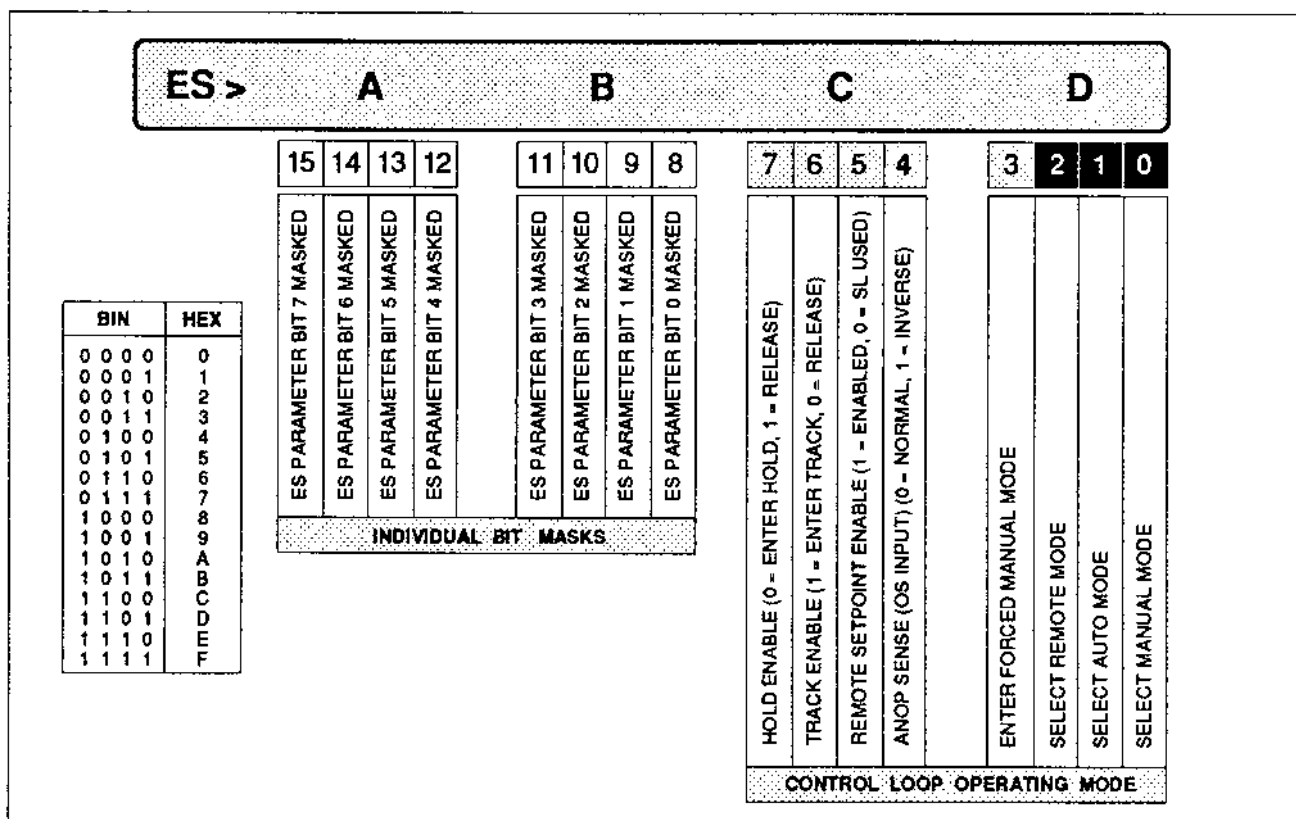

Figure 4.25 ES Parameter — XPID Control Block

Control Loop Operating Mode — Digits C & D

Digits C and D set the control loop operating mode. Any mode changes are also reflected in the parameter MD. If your control strategy has connections going to any of the control block's mode-selection digital inputs (e.g. MA), digits C and D can become read-only under certain conditions. Please refer to Chapter 7, *Control Loop Operating Modes*, for details on this and on mode priorities.

- **Hold Enable — Bit 7.** Setting this bit to logic 0 causes the control loop to enter HOLD. A logic 1 releases the loop from HOLD, letting it enter the operating mode with next highest priority.
- **Track Enable — Bit 6.** Setting this bit to logic 1 causes the control loop to enter TRACK. A logic 0 releases the loop from TRACK, letting it enter the operating mode with next highest priority.

NOTE. When the loop being displayed is in TRACK or HOLD mode, 6372 and 6382 instruments flash the relevant loop LED on the fascia. 6370/80 (single-loop) instruments have dedicated TRACK and HOLD LEDs.

- **Remote Setpoint Enable — Bit 5.** Setting this bit to logic 1 enables the XPID block to use the remote setpoint SR instead of the local setpoint SL, provided REMOTE has been selected. A logic 0 selects SL as the setpoint source, and prevents REMOTE being selected.

- **ANOP Block Output Sense — Bit 4.** Bit 4 is set by the block's ANOP Output Sense input (OS): 0 = *normal* operation, 1 = *inverse* operation. It is referred to by the control block at shutdown and power-up if the default mode of operation has been disabled, and if bit 2 of the 3T parameter has been set to logic 1. Then, the state of ES bit 4 determines whether the block output MO (via a Manual Station) sets to the High or the Low Output Limit (HL or LL) as a fail-safe condition.

If the default mode has been *enabled*, input OS should not be connected to. In this case the control block always refers to the relevant *default* ANOP block at shutdown and power-up (i.e. B4 for M1, and B3 for M2).

(Please refer to the section on the 3T parameter for details of shutdown and power-up action.)

- **Forced Manual Mode Select — Bit 3.** Setting this bit to logic 1 causes the control loop to enter the FORCED MANUAL mode. The yellow LED on the 'M' fascia button *flashes* (if the loop is being displayed). A logic 0 releases the loop from FORCED MANUAL, leaving it operating in MANUAL mode. As a fail-safe measure after a loop program halt, bit 3 automatically sets to logic 1. This causes the loop to adopt FORCED MANUAL mode when it restarts, unless a connection to the FM digital input resets bit 3.

- **Remote Mode Select — Bit 2.** Setting this bit to logic 1 causes the control loop to select REMOTE mode, provided that bit 5 is at logic 1. Bit 2 is write-only, i.e. it automatically resets after execution and so always reads back as logic 0.

- **Auto Mode Select — Bit 1.** Setting this bit to logic 1 causes the control loop to select AUTO mode. Bit 1 is write-only, i.e. it automatically resets after execution and so always reads back as logic 0.

- **Manual Mode Select — Bit 0.** Setting this bit to logic 1 causes the control loop to select MANUAL mode. Bit 0 is write-only, i.e. it automatically resets after execution and so always reads back as logic 0.

NOTE. The MD parameter changes to indicate the current loop operating mode whenever any of the above bits are altered.

Use of the ES Parameter — Examples

- Example 1** ES>FE01 Only bit 0 is unmasked by digits A and B, so the control loop is set to MANUAL mode.
- Example 2** ES>FEFF The mask pattern is the same as in Example 1, so the control loop is again set to MANUAL mode.
- Example 3** ES>7F00 This unmask bit 7 and writes it to a zero, setting the control loop into HOLD mode.
- Example 4** ES>0080 Resets control loop to normal operation with REMOTE mode disabled.
- Example 5** ES>00A0 Resets control loop to normal operation with REMOTE mode enabled.

MD Loop Operating Mode

Figure 4.26 shows the meanings of the hexadecimal digits in the MD parameter of the XPID Control block. (The symbols used in the parameter diagram are explained in Figure 4.2.)

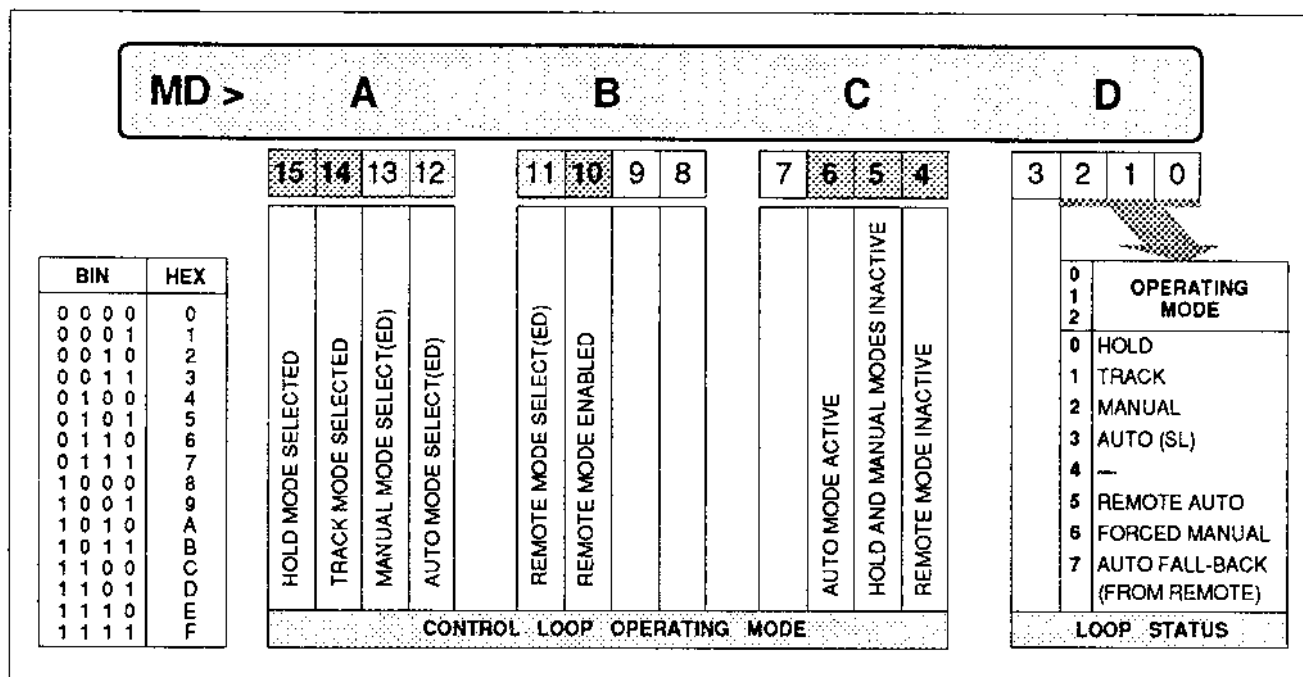

Figure 4.26 MD Parameter — XPID Control Block

Control Loop Operating Mode — Digits A, B, & C

The action of most of the *read-only* bits is clear from Figure 4.26: they simply indicate the current operating mode. The other *read-write* bits are explained further below.

- **Manual Mode Select(ed) — Bit 13.** This bit sets to logic 1 whenever the control loop is in MANUAL mode or MANUAL is the suppressed mode (and whenever a logic 1 is written to bit 0 of the ES parameter). But, because of its read-write status, you can also *select* MANUAL mode by entering a value of 2000 for the MD parameter.
- **Auto Mode Select(ed) — Bit 12.** This bit sets to logic 1 whenever the control loop is in AUTO mode or AUTO is the suppressed mode (and whenever a logic 1 is written to bit 1 of the ES parameter). But, because of its read-write status, you can also *select* AUTO mode by entering a value of 1000 for the MD parameter.
- **Remote Mode Select(ed) — Bit 11.** This bit sets to logic 1 whenever the control loop is in REMOTE AUTO mode (and whenever a logic 1 is written to bit 2 of the ES parameter). But, because of its read-write status, you can also *select* REMOTE AUTO mode by entering a value of 0800 for the MD parameter, provided REMOTE SETPOINT has been enabled (ES bit 5 high).

NOTE. MD bit 13, 12, or 11 (and digit D) becomes *read-only* if your control strategy has a connection going to the block's corresponding mode-selection digital input (MA, AU, or RA) which is at logic 1.

Control Loop Operating Mode Number — Digit D

The total value of bits 0, 1, and 2 (the *mode number*) gives a supervisory computer a direct indication of which of the seven possible XPID block operating modes is currently active. The meaning of each mode number is shown in Figure 4.26 (digit D).

NOTE. If HOLD or TRACK are active, with FORCED MANUAL as the suppressed mode, the mode number indicated is 6, not 0 or 1. This keeps a supervisory system informed of the alarm situation.

Table 4.25 shows the degree of control you have over the operating modes via the serial data links, RS232 (Hand-Held Terminal) and RS422.

Mode Number	Operating Mode	Selection via RS232/422
0	HOLD	Read-only
1	TRACK	Read-only
2	MANUAL	Selectable
3	AUTO (Local Setpoint)	Selectable
4	(unused in XPID block)	—
5	REMOTE AUTO (Cascade)	Selectable in REMOTE only
6	FORCED MANUAL	Read-only
7	AUTO FALL-BACK (from REMOTE)	Automatically selected if mode 5 entered and ES bit 5 set to logic 0

Table 4.25 Selection of Loop Operating Mode via Serial Data Links

SM Front Panel Pushbutton Mask

Figure 4.27 shows the meanings of the hexadecimal digits in the SM parameter of the XPID Control block. (The symbols used in the parameter diagram are explained in Figure 4.2.)

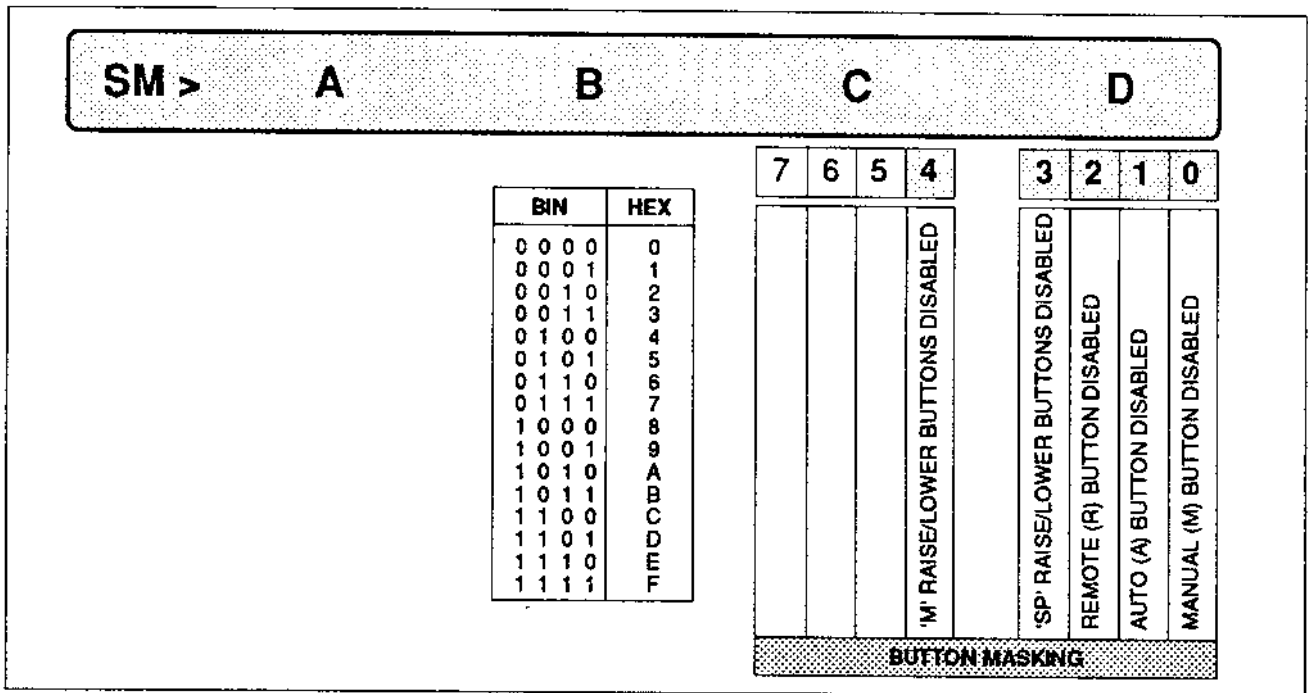

Figure 4.27 SM Parameter — XPID Control Block

The SM parameter lets you disable any of the three front-panel control mode pushbuttons, Remote (R), Auto (A), and Manual (M) so that they cannot be used by an operator. You can also independently disable the setpoint adjustment ('SP' plus 'raise/lower' buttons) and the controller output adjustment ('M' plus 'raise/lower' buttons).

Example 1 SM>0000 All pushbuttons are enabled.

Example 2 SM>000E Permits use of only the Manual (M) pushbutton, and the controller output adjustment.

FC Function Control Register

The FC parameter is explained on page 4.19. Please refer there for details.

XCON: CONTROL BLOCK

Block Function

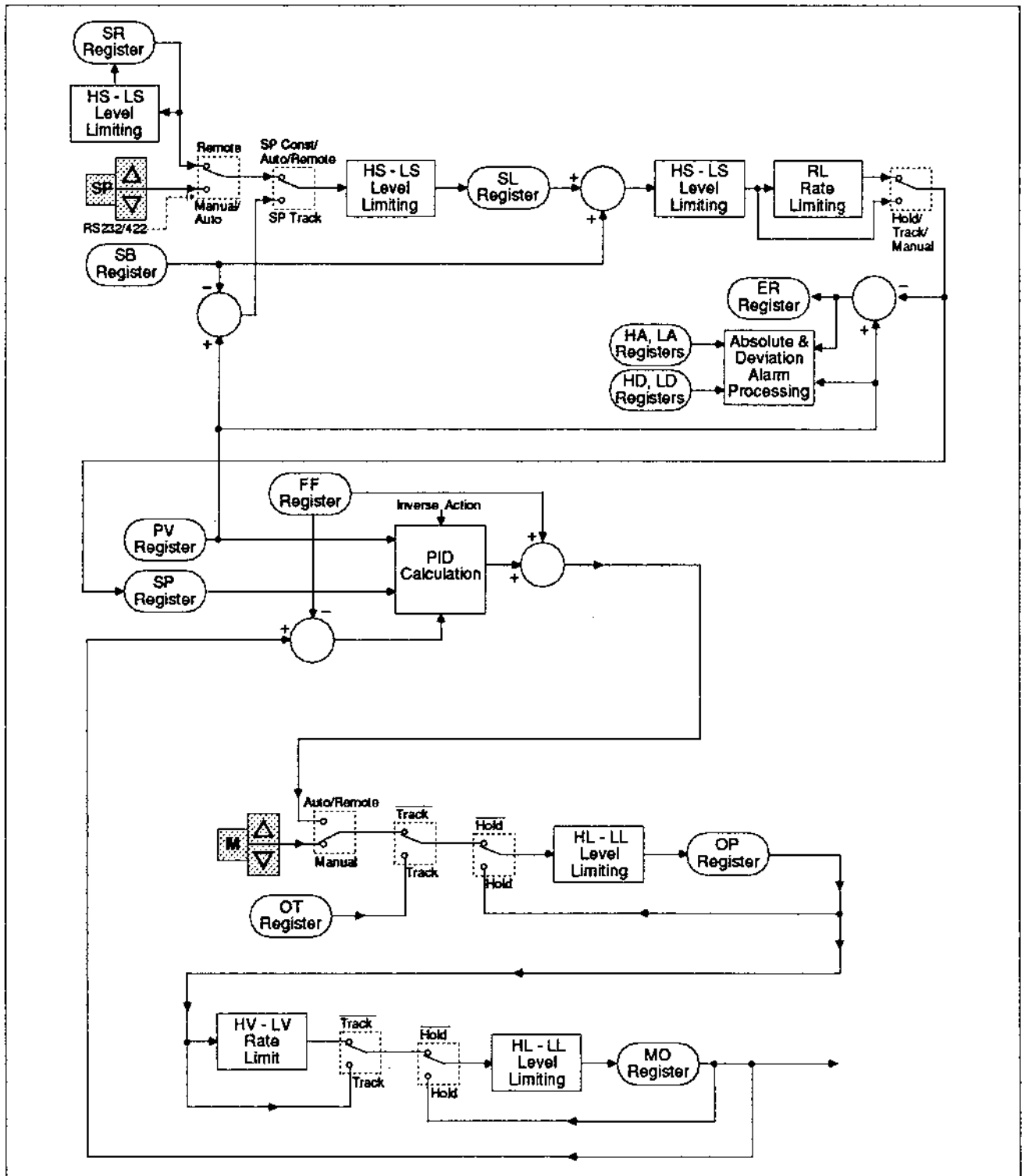

Figure 4.28 XCON Block Schematic

Please refer to Figure 4.28. The XCON block is effectively an XPID control block (upper half of the schematic) linked to a MANS manual station block (lower half). It combines setpoint generation, PID closed loop control, and manual intervention in a single block. The XPID block (page 4.37) and MANS block (page 4.31) descriptions apply equally to the XCON block, except in the following respects:

- In the XCON block, the output from the PID calculation is not held in a register as the OP parameter (as it is in the XPID block). Instead, it is passed directly to the manual station section of the block (the lower part of the schematic). Also, no MI register is required. After HL - LL limiting the PID output becomes the OP parameter, which is therefore a more processed version of the XPID block's OP parameter.
- The MO parameter is permanently linked to the PID calculation section as feedback, and so no FB parameter is needed. The PID calculation compares the feedback MO value (less any FF offset) with its calculated control output, and then implements any required integral desaturation. Please refer to TCS publication *System 6000 Controller Applications* for details on integral desaturation.

Block Connections

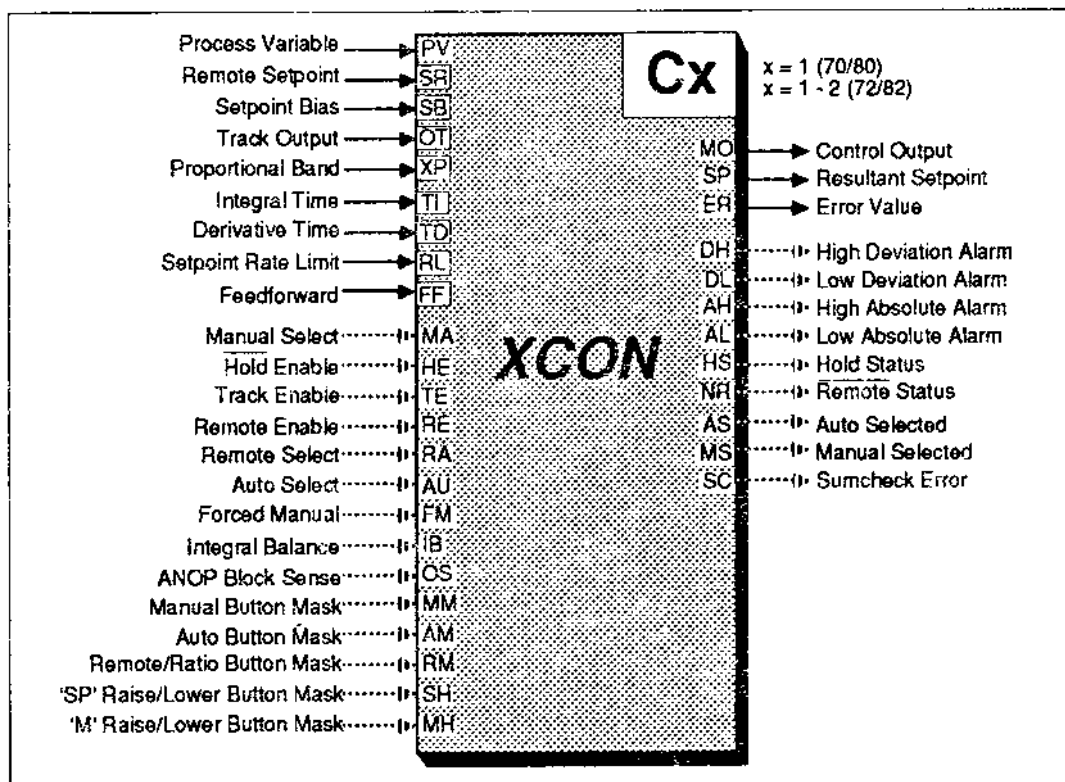

Figure 4.29 XCON Block Connections

Figure 4.29 represents all the XCON blocks in the instrument (one or two blocks depending on model). Each block has its own parameter set and can be installed at its own address. (*Control Block Addresses*: see Notes 1 and 2 on page 4.2).

Incoming Connections. The connections coming into the XCON block are summarised in Table 4.26.

Code	Connection	Function	Format*
PV	Process Variable	Scaled by PH, PL	FP
SR	Remote Setpoint	Value before bias is added. Limited by HS, LS	FP
SB	Setpoint Bias	Bias added to SL to form SP	FP
OT	Track Output	Updates OP register when control loop is in TRACK mode	FP
XP	Proportional Band	Reciprocal of PID loop overall gain, expressed as percentage	FP
TI	Integral Time	Time constant (TI) used in PID calc.	FP
TD	Derivative Time	Time constant (TD) used in PID calc.	FP
RL	Setpoint Rate Limit	Maximum rate at which SP can change	FP
FF	Feedforward	Bias added to result of PID calc.	FP
MA	Manual Select	Logic 1 selects MANUAL	0/1
HE	Hold Enable	Logic 0 enables HOLD mode	0/1
TE	Track Enable	Logic 1 enables OT TRACK mode	0/1
RE	Remote Enable	Logic 1 enables REMOTE mode	0/1
RA	Remote Select	Logic 1 selects REMOTE mode	0/1
AU	Auto Select	Logic 1 selects AUTO mode	0/1
FM	Forced Manual	Logic 1 selects FORCED MANUAL	0/1
IB	Integral Balance	Logic 1 triggers integral balance	0/1
OS	ANOP Block Sense	Logic 0 signifies direct O/P set Logic 1 signifies inverse O/P set (Sets ES parameter bit 4)	0/1
MM	Manual Button Mask	Logic 1 disables 'M' button	0/1

AM	Auto Button Mask	Logic 1 disables 'A' button	0/1
RM	Remote/Ratio Button Mask	Logic 1 disables 'R' button	0/1
SH	'SP' Raise/Lower Button Mask	Logic 1 disables 'SP' Δ / ∇ Buttons	0/1
MH	'M' Raise/Lower Button Mask	Logic 1 disables 'M' Δ / ∇ Buttons	0/1

Table 4.26 XCON Incoming Connections

NOTE. PV is the only input that *must* be connected to another block for its data source. You can update other inputs via connections or via the Hand-Held Terminal or RS422 data link. Figure 4.29 shows this by 'boxing-in' the optional connections. However, if FM (Forced Manual) is unconnected the program starts up in FORCED MANUAL mode. As a fail-safe measure FM should be wired so that FORCED MANUAL takes over whenever a sumcheck error or other significant failure occurs. Connect, for example, the GENP block's common block sumcheck error output (CS), OR'd with open-circuit flags (OC or O3) from the ANIN block supplying PV.

NOTE. When *default mode* is not in use, the OS (Output Sense) output of the ANOP block must be connected to the OS input of the control block connected to its AO input. If this is not done the operation of fail-safe measures may be undefined.

Outgoing Connections. Table 4.27 summarises the outgoing connections from the XCON block, available for connecting to another block (or blocks).

Code	Connection	Function	Format*
MO	Control Output	Block output, limited by HV-LV, HL-LL, via manual station	FP
SP	Resultant Setpoint	Local Setpoint value (SL) after biasing and limiting	FP
ER	Error Value	PV - SP	FP
DH	High Deviation Alarm	Sets to 1 if PV-SP > HD	0/1
DL	Low Deviation Alarm	Sets to 1 if SP-PV > LD	0/1
AH	High Absolute Alarm	Sets to 1 if PV > HA	0/1
AL	Low Absolute Alarm	Sets to 1 if PV < LA	0/1
HS	Hold Status	Sets to 1 if HOLD mode active	0/1
NR	Remote Status	Sets to 0 if REMOTE mode active, 1 if not active	0/1

AS	Auto Selected	Sets to 1 if AUTO mode selected	0/1
MS	Manual Selected	Sets to 1 if MANUAL mode selected	0/1
SC	Sumcheck Error	Latches to 1 on sumcheck failure	0/1

Table 4.27 XCON Outgoing Connections

Block Parameters

Table 4.28 lists the XCON parameters and the units or format in which they are expressed.

Mnemonic	Parameter	Format*
ST	Block Status	HHHH
PH	Setpoint & PV High Range	±Eng.
PL	Setpoint & PV Low Range	±Eng.
HS	Setpoint High Limit	±Eng.
LS	Setpoint Low Limit	±Eng.
HA	High Absolute PV Alarm	±Eng.
LA	Low Absolute PV Alarm	±Eng.
HD	High Deviation Alarm	Eng.
LD	Low Deviation Alarm	Eng.
SL	Local Setpoint	±Eng.
SR	Remote Setpoint	±Eng.
SB	Setpoint Bias	±Eng.
ER	Error (PV - SP)	±Eng.
RL	Setpoint Rate Limit	±Eng./s
3T	PID Status	HHHH
XP	Proportional Band Constant	1000%
TI	Integral Time Constant	100
TD	Derivative Time Constant	100
TS	Algorithm Sampling Time	100
FF	Feedforward Term	±100%
SP	Resultant Internal Setpoint	±Eng.
PV	Process Variable	±Eng.
ES	Enable Status	HHHH
MD	Loop Operating Mode	HHHH
SM	Front Panel Pushbutton Mask	HHHH
HV	Output Incremental Rate Limit	100%/s
LV	Output Decremental Rate Limit	100%/s
HL	High Output Limit	100%
LL	Low Output Limit	100%
MO	Control Output	100%
OP	Output Demanded	100%
OT	Output Track Value	100%
FC	Function Control Register	HHHH

Table 4.28 XCON Block Parameters

*See Table 4.2 for an explanation of these formats

With few exceptions, the XCON block parameters have functions that correspond exactly to the similarly-named parameters of the MANS block (page 4.31) and XPID block (page 4.37). Please refer to those sections for details.

NOTE. The XCON block ST parameter corresponds to the XPID block ST parameter (not to the MANS block ST parameter).

The XCON block parameters whose meanings *do not* correspond exactly with those of the MANS and XPID blocks are detailed below.

3T PID Status

This parameter is almost identical to the 3T parameter in the XPID block, shown in Figure 4.24. The only slight difference is in the action of bits 5 and 4 of digit C.

- **Output Limits — Bits 5 & 4.** (Please refer to Figure 4.24.) These bits indicate when the output of the PID calculation has reached a limit.

Limits are detected by comparing the calculated PID output with the feedback value of MO (both minus any FF offset). MO is an absolute- and rate-limited version of the PID output, and they are normally equal. If the PID output exceeds MO a high output limit has been reached; if the PID output is less than MO a low output limit has been reached.

FF Feedforward Term

The FF parameter effectively defines the bias value added to the output of the PID calculation before it passes to the manual station section of the XCON block, on its way to becoming the OP parameter. Setting FF to, say, 50% allows *negative* control outputs to be represented as OP falling below 50%.

MO Control Output

MO is the resultant output of the XCON block, limited by HV-LV and HL-LL, expressed as a percentage of the full-scale operating range (0 to 99.99%).

MO is fed back to the PID section of the block where (after subtraction of any FF offset) it is compared with the calculated PID output. If the two values differ, integral desaturation measures are automatically taken by the instrument.

OP Output Demanded

The OP parameter can derive from several sources, depending on the control loop operating mode. In all cases OP is limited by the HL (High Limit) and LL (Low Limit) parameters.

- **MANUAL mode.** OP is varied by the raise/lower buttons on the instrument front panel.
- **TRACK mode.** OP is forced to track the OT (Track Output) parameter. It cannot be altered but only monitored via the front panel or serial data links.
- **AUTO/REMOTE mode.** OP is the output value of the 3-term PID control algorithm after feed-forward bias has been added (and HL-LL level limiting has been applied).

RPID: RATIO CONTROL BLOCK

Block Function

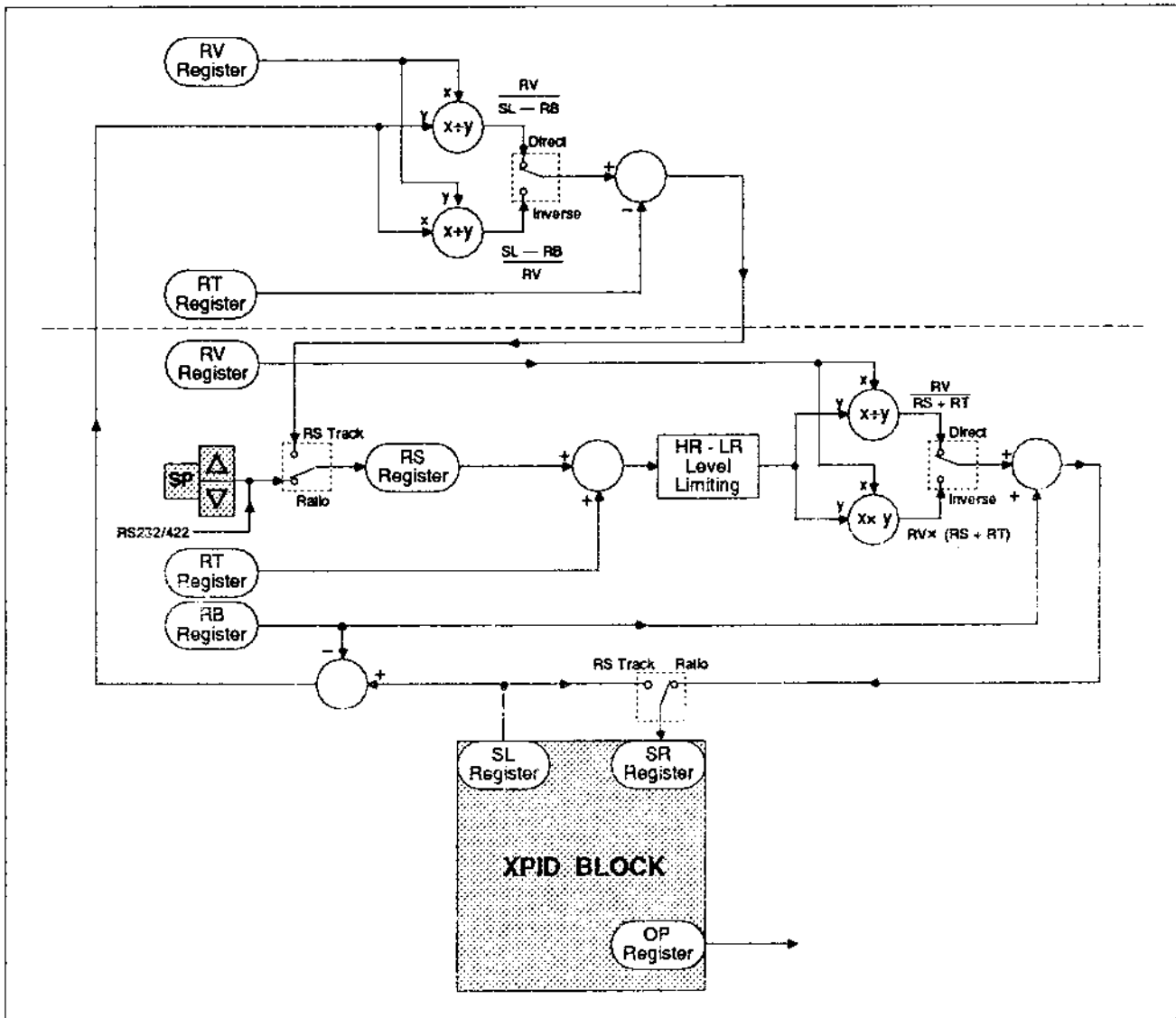

Figure 4.30 RPID Block Schematic

Please refer to Figure 4.30. The RPID Ratio Control block is basically an XPID Control block adapted to perform *ratio control* on a secondary process variable (RV). Under RATIO control the setpoint SR is essentially a direct or inverse *proportion* of a 'secondary' process variable input RV. The 'constant of proportionality' is the Ratio Setting parameter RS (trimmed by RT) and is adjustable via the front panel, control strategy, or either data link. This distinguishes RATIO from REMOTE control, where the setpoint is driven directly by an external signal.

NOTE. The RPID block has no built-in manual station. If you want to be able to manually adjust the block's output control signal (OP) you should use an *RCON* Ratio Control block or add a MANS block.

The XPID block in the schematic is identical to the block shown in the section on the XPID Control block (Figure 4.21, page 4.37). Please refer to that section for a detailed description of the block function and parameters.

Ratio Setpoint, SR. The RPID block generates a Ratio Setpoint, held in the SR register. After limiting and biasing, SR ultimately becomes SP, the resultant internal setpoint, used by the PID control algorithm to control the Primary Process Variable (PV). In RATIO mode, the ratio setpoint SR is derived from the Ratio Setting parameter RS, and the Ratio (Secondary) Process Variable input RV.

For example, you may want to keep a measured combustion air flow (PV) at a controlled ratio (RS) to a measured gas flow (RV). The required air flow setpoint is calculated as SR.

Operating Modes

The action of the RPID block depends primarily on whether or not it is in RATIO mode. Its action when *not* in RATIO mode further depends on whether RATIO TRACK has been selected.

RATIO Mode

The upper part of the schematic in Figure 4.30 (above the dashed line) is inactive in RATIO mode.

Ratio Setting, RS. RS is varied by the raise/lower buttons on the instrument front panel, and can also be monitored and updated via either of the serial links.

After RS has been subjected to Ratio Trim (RT) and level limiting (HR, LR), the Ratio Setpoint SR is calculated by one of two ways depending on whether *Direct* or *Inverse* ratio operation has been selected (see the lower part of the schematic):

- **Direct Ratio Operation.** Ratio Setpoint (before bias) is calculated as:

$$\text{Ratio Setpoint (SR)} = \frac{\text{Ratio Process Variable (RV)}}{\text{Ratio Setting (RS)} + \text{Ratio Trim (RT)}}$$

- **Inverse Ratio Operation.** Ratio Setpoint (before bias) is calculated as:

$$\text{Ratio Setpoint (SR)} = \text{Ratio Process Variable (RV)} \times [\text{Ratio Setting (SR)} + \text{Ratio Trim (RT)}]$$

In both operating modes, Ratio Bias (RB) is added to the calculated result before it becomes the SR parameter.

RATIO Mode Inoperative

Ratio Setting, RS. With RATIO TRACK mode de-selected (RA bit 10 low) RS remains constant. With this mode selected (bit 10 high) RS derives from the local setpoint parameter SL, which is connected back to the now active upper part of the schematic (Figure 4.30). RS is 'back-calculated' from SL and stored in the RS register, which is continuously updated but *not further processed*. (In this mode, SR tracks SL and so is independent of RS.)

The back-calculation keeps RS updated with a value such that the ratio setpoint SR that would be produced from this value equals the prevailing local setpoint SL. This ensures that SL is not 'bumped' on subsequent return to RATIO mode.

The back-calculation used to derive RS depends on whether *Direct* or *Inverse* operation has been selected:

- **Direct Ratio Operation.** The Ratio Setting is back-calculated as:

$$RS' = \left[\frac{RV}{SL - RB} - RT \right]$$

which subsequently gives a Ratio Setpoint of:

$$SR = \frac{RV}{RS' + RT} + RB$$

i.e.

$$SR = \frac{RV}{\left[\frac{RV}{SL - RB} - RT \right] + RT} + RB = SL$$

for a bumpless return to RATIO mode.

- **Inverse Ratio Operation.** The Ratio Setting is back-calculated as:

$$RS' = \left[\frac{SL - RB}{RV} - RT \right]$$

which subsequently gives a Ratio Setpoint of:

$$SR = RV \times (RS' + RT) + RB$$

i.e.

$$SR = RV \times \left(\left[\frac{SL - RB}{RV} - RT \right] + RT \right) + RB = SL$$

for a bumpless return to RATIO mode.

Block Connections

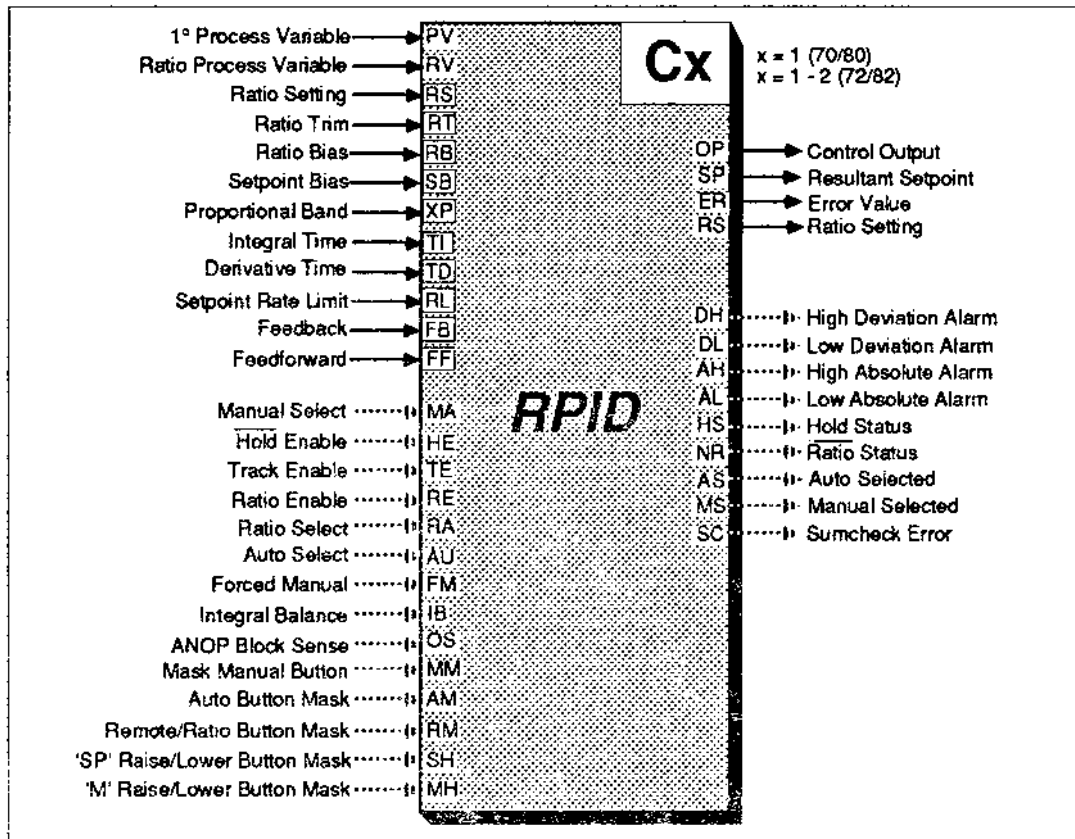

Figure 4.31 RPID Block Connections

Figure 4.31 represents all the RPID blocks in the instrument (one or two blocks depending on model). Each block has its own parameter set and can be installed at its own address. (*Control Block Addresses: see Notes 1 and 2 on page 4.2.*)

Incoming Connections. The connections coming into the RPID block are summarised in Table 4.29.

Code	Connection	Function	Format*
PV	1° Primary Process	The controlled variable. Scaled by PH, PL	FP
RV	Ratio Process Variable	The secondary (wild) variable.	FP
RS	Ratio Setting	RS parameter value	FP
RT	Ratio Trim	Trim value added to RS before generation of SR	FP
RB	Ratio Bias	Bias value added to calculated ratio setpoint before it becomes SR parameter. Scaled by PH, PL	FP

FIXED BLOCKS

RPID

SB	Setpoint Bias	Bias added to SL to form SP	FP
XP	Proportional Band	Reciprocal of PID loop overall gain, expressed as percentage	FP
TI	Integral Time	Time constant (TI) used in PID calc.	FP
TD	Derivative Time	Time constant (TD) used in PID calc.	FP
RL	Setpoint Rate Limit		FP
FB	Feedback	PID output OP fed back to PID calculation after limiting via MANS	FP
FF	Feedforward	Bias added to result of PID calc.	FP
MA	Manual Select	Logic 1 selects MANUAL mode	0/1
HE	Hold Enable	Logic 0 enables HOLD mode	0/1
TE	Track Enable	Logic 1 enables OT TRACK mode (when MANS connected)	0/1
RE	Ratio Enable	Logic 1 enables RATIO mode	0/1
RA	Ratio Select	Logic 1 selects RATIO mode	0/1
AU	Auto Select	Logic 1 selects AUTO mode	0/1
FM	Forced Manual	Logic 1 selects FORCED MANUAL	0/1
IB	Integral Balance	Logic 1 triggers integral balance	0/1
OS	ANOP Block Sense	Logic 0 signifies direct O/P set Logic 1 signifies inverse O/P set (Sets ES parameter bit 4)	0/1
MM	Manual Button Mask	Logic 1 disables 'M' button	0/1
AM	Auto Button Mask	Logic 1 disables 'A' button	0/1
RM	Remote/Ratio Button Mask	Logic 1 disables 'R' button	0/1
SH	'SP' Raise/Lower Button Mask	Logic 1 disables 'SP' Δ / ▽ Buttons	0/1
MH	'M' Raise/Lower Button Mask	Logic 1 disables 'M' Δ / ▽ Buttons	0/1

Table 4.29 RPID Incoming Connections

*See Table 4.2 for an explanation of these formats

NOTE. PV and RV are the only inputs that *must* be connected to other blocks for their data sources. You can update other inputs via connections or via the Hand-Held Terminal or RS422 data link. Figure 4.31 shows this by 'boxing-in' the optional connections. For the control block to function correctly, however, FB (Feedback) should be connected. Also, if FM (Forced Manual) is unconnected the program starts up in FORCED MANUAL mode. As a fail-safe measure FM should be wired so that FORCED MANUAL takes over whenever a sumcheck error or other significant failure occurs. Connect, for example, the GENP block's common block sumcheck error output (CS), OR'd with open-circuit flags (OC or O3) from the ANIN block supplying PV.

NOTE. When *default mode* is not in use, the OS (Output Sense) output of the ANOP block must be connected to the OS input of the control block connected to its AO input. If this is not done the operation of fail-safe measures may be undefined.

Outgoing Connections. Table 4.30 summarises the outgoing connections from the RPID block, available for connecting to another block (or blocks).

Code	Connection	Function	Format*
OP	Control Output	PID output, including biasing	FP
SP	Resultant Setpoint	Local Setpoint value (SL) after biasing and limiting	FP
ER	Error Value	PV - SP	FP
RS	Ratio Setting	RS parameter value	FP
DH	High Deviation Alarm	Sets to 1 if PV-SP > HD	0/1
DL	Low Deviation Alarm	Sets to 1 if SP-PV > LD	0/1
AH	High Absolute Alarm	Sets to 1 if PV > HA	0/1
AL	Low Absolute Alarm	Sets to 1 if PV < LA	0/1
HS	Hold Status	Sets to 1 if HOLD mode active	0/1
NR	Ratio Status	Sets to 0 if RATIO mode active, 1 if RATIO mode inactive	0/1
AS	Auto Selected	Sets to 1 if AUTO mode selected	0/1
MS	Manual Selected	Sets to 1 if MANUAL mode selected	0/1
SC	Sumcheck Error	Latches to 1 on sumcheck failure	0/1

Table 4.30 RPID Outgoing Connections

Block Parameters

Table 4.31 lists the RPID parameters and the units or format in which they are expressed.

Mnemonic	Parameter	Format*
ST	Block Status	HHHH
PH	Setpoint & PV High Range	±Eng.
PL	Setpoint & PV Low Range	±Eng.
RA	Ratio Status	HHHH
HR	High Ratio Setting Limit	9999
LR	Low Ratio Setting Limit	9999
HS	Setpoint High Limit	±Eng.
LS	Setpoint Low Limit	±Eng.
HA	High Absolute PV Alarm	±Eng.
LA	Low Absolute PV Alarm	±Eng.
HD	High Deviation Alarm	Eng.
LD	Low Deviation Alarm	Eng.
SL	Local Setpoint	±Eng.
SR	Ratio Setpoint	±Eng.
SB	Setpoint Bias	±Eng.
ER	Error (PV – SP)	±Eng.
RL	Setpoint Rate Limit	±Eng./s
3T	PID Status	HHHH
XP	Proportional Band Constant	1000%
TI	Integral Time Constant	100
TD	Derivative Time Constant	100
TS	Algorithm Sampling Time	100
FF	Feedforward Term	±100%
FB	Feedback Term	100%
RS	Ratio Setting	9999
RT	Ratio Trim	±9999
RB	Ratio Bias	±Eng.
OP	PID Control Output	100%
SP	Resultant Internal Setpoint	±Eng.
PV	Primary Process Variable	±Eng.
ES	Enable Status	HHHH
MD	Loop Operating Mode	HHHH
SM	Front Panel Pushbutton Mask	HHHH
FC	Function Control Register	HHHH

Table 4.31 RPID Block Parameters

*See Table 4.2 for an explanation of these formats

With one exception (MD), the parameters related to the 'XPID' part of the block have functions that correspond exactly to the similarly-named parameters of the XPID block itself (page 4.42). Please refer to that section for details.

NOTE. In the XPID section, you should read 'RPID' instead of 'XPID' in the parameter descriptions.

Also, in the XPID block schematic (Figure 4.21) you should read 'Ratio' instead of 'Remote', when applying the schematic to the RPID block.

MD and the remaining RPID block parameters are detailed below.

MD Loop Operating Mode

Figure 4.32 shows the meanings of the hexadecimal digits in the MD parameter of the RPID Ratio Control block. (The symbols used in the parameter diagram are explained in Figure 4.2.)

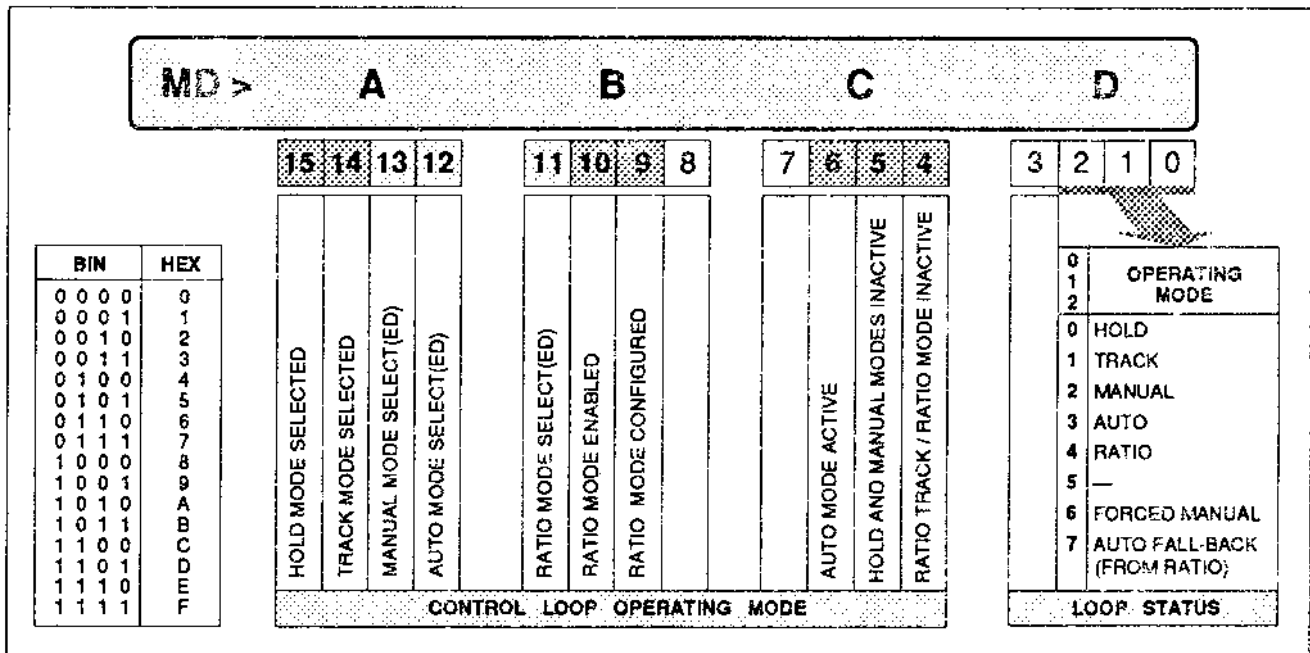

Figure 4.32 MD Parameter — RPID Ratio Control Block

Control Loop Operating Mode — Digits A, B, & C

The action of most of the *read-only* bits is clear from Figure 4.32: they simply indicate the current operating mode. The other *read-write* bits are explained further below.

- **Manual Mode Select(ed) — Bit 13.** This bit sets to logic 1 whenever the control loop is in MANUAL mode or MANUAL is the suppressed mode (and whenever a logic 1 is written to bit 0 of the ES parameter). But, because of its read-write status, you can also *select* MANUAL mode by entering a value of 2000 for the MD parameter.

- **Auto Mode Select(ed) — Bit 12.** This bit sets to logic 1 whenever the control loop is in AUTO mode or AUTO is the suppressed mode (and whenever a logic 1 is written to bit 1 of the ES parameter). But, because of its read-write status, you can also *select* AUTO mode by entering a value of 1000 for the MD parameter.

- **Ratio Mode Select(ed) — Bit 11.** This bit sets to logic 1 whenever the control loop is in RATIO mode (and whenever a logic 1 is written to bit 2 of the ES parameter). But, because of its read-write status, you can also *select* RATIO mode by entering a value of 0800 for the MD parameter, provided REMOTE SETPOINT has been enabled (ES bit 5 high).

NOTE. MD bit 13, 12, or 11 (and digit D) becomes read-only if your control strategy has a connection going to the block's corresponding mode-selection digital input (MA, AU, or RA) which is at logic 1.

Control Loop Operating Mode Number — Digit D

The total value of bits 0, 1, and 2 (the *mode number*) gives a supervisory computer a direct indication of which of the seven possible RPID block operating modes is currently active. The meaning of each mode number is shown in Figure 4.32 (digit D).

Table 4.32 shows the degree of control you have over the operating modes via the serial data links, RS232 (Hand-Held Terminal) and RS422.

Mode Number	Operating Mode	Selection via RS232/422
0	HOLD	Read-only
1	TRACK	Read-only
2	MANUAL	Selectable
3	AUTO	Selectable
4	RATIO	Selectable
5	(Unused in RPID block)	—
6	FORCED MANUAL	Read-only
7	AUTO FALL-BACK	Automatically selected if mode 4 entered and ES bit 5 set to logic 0

Table 4.32 Selection of Loop Operating Mode via Serial Data Links

RA Ratio Status

Figure 4.33 shows the meanings of the hexadecimal digits in the RA parameter of the RPID Ratio Control block. (The symbols used in the parameter diagram are explained in Figure 4.2.)

Decimal Point Selection — Digit A

Digit A selects the decimal point position, as displayed on the Hand-Held Terminal, for all the dimensionless parameters in the RPID block, i.e. HR, LR, RS, and RT.

Ratio Mode — Digit B

Bit 10 of Digit B determines what happens to the ratio setting parameter RS when the loop is not operating in RATIO mode. If bit 10 is set to 0, RS remains *constant*. If bit 10 is set to 1, RS is 'back-calculated' so that the resultant ratio setpoint SR *tracks* the local setpoint SL. This ensures a bumpless changeover on subsequent return to RATIO mode.

The back-calculation method used to keep RS at the correct value is explained above, in the 'Ratio Mode Inoperative' section (page 4.68).

Ratio Sense — Digit D

Set bit 0 of digit D to logic 0 to select *direct* ratio operation. Set bit 0 of digit D to logic 1 to select *inverse* ratio operation. These terms are defined above, in the 'Ratio Mode' section (page 4.67).

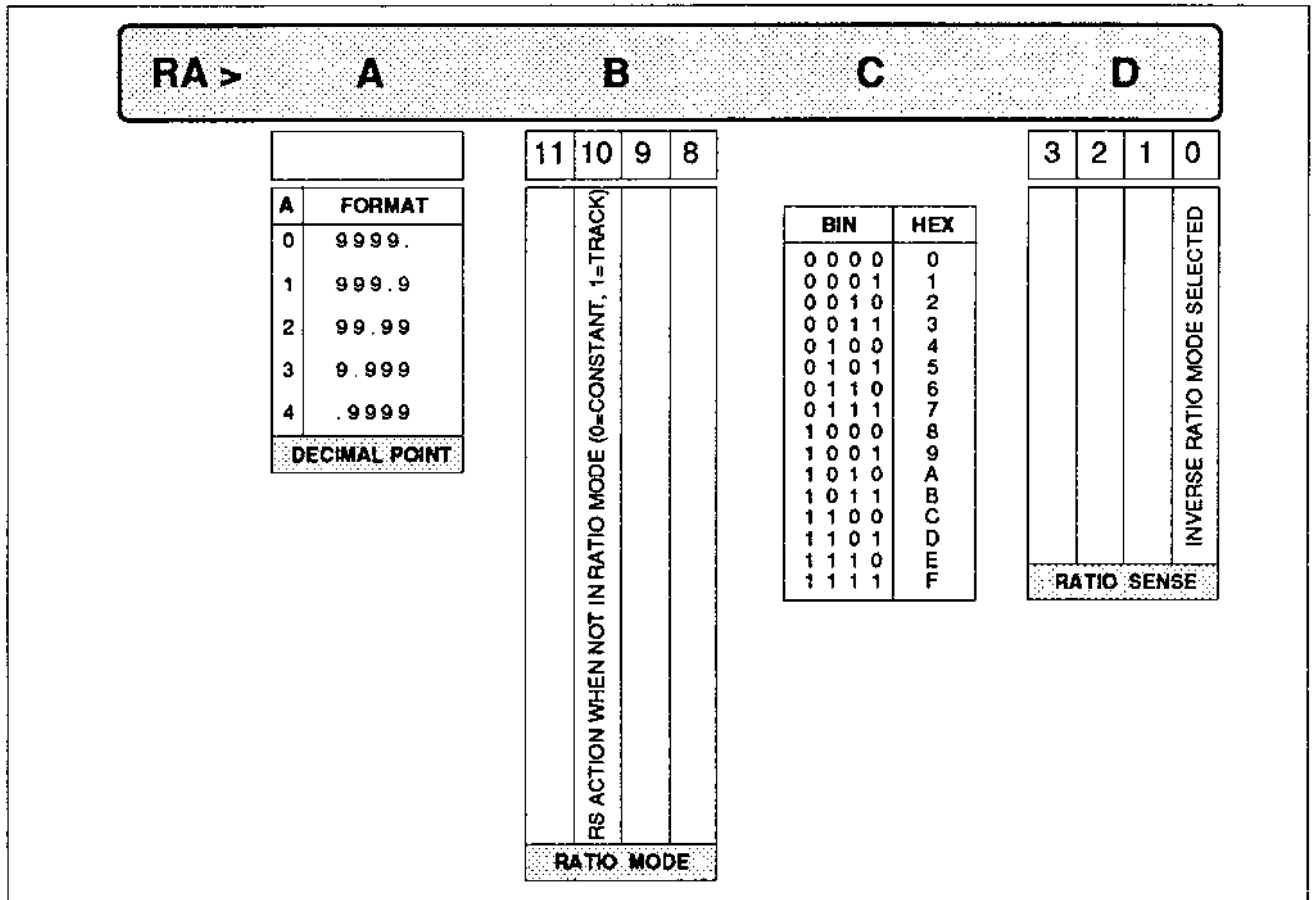

Figure 4.33 RA Parameter — RPID Ratio Control Block

HR & LR Ratio Setting Limits

The High and Low Ratio Setting Limits, HR and LR, limit the range over which the ratio setting parameter RS can be varied. Note from the block schematic (Figure 4.30) that the limits are applied *after* ratio trim (RT) has been added.

HR must be greater than or equal to LR. Setting HR equal to LR ‘clamps’ RS to this value and prevents it from being altered by any means. Digit A of the RA parameter sets the decimal point position of these (dimensionless) parameters.

SR Ratio Setpoint

SR defines, in engineering units, the setpoint which after limiting and biasing ultimately becomes SP, the resultant internal setpoint used by the PID algorithm to control the primary process variable PV. Its decimal point position is set by the ST parameter, and it is ranged by the PL and PH parameters (refer to the XPID block section).

In **RATIO** mode, **SR** derives from the ratio (secondary) process variable **RV** and the ratio setting parameter **RS**. Please refer to the block schematic in Figure 4.30.

In **TRACK** mode with bit 10 of the **RA** parameter set to logic 1, **SR** tracks the local setpoint **SL**, and **RS** is updated such that the return to **RATIO** mode is bumpless. With bit 10 set to logic 0, **RS** and **SR** remain constant and so the return may not be bumpless.

RS Ratio Setting

RS is the ratio setting value used to calculate the ratio setpoint **SR**, as detailed above under 'Operating Modes' (page 4.67). The **RS** value must always lie in the range defined by **HR** and **LR**, the ratio setting limit parameters.

In **RATIO** mode, you can alter **RS** directly via the front panel raise/lower buttons or either of the serial links. In **AUTO** or **MANUAL**, only the serial links can be used to alter **RS**.

RS is a dimensionless number and its decimal point position is set by digit **A** of the **RA** parameter.

RT Ratio Trim

RT is the trim value added to the ratio setting **RS** before it is used to calculate the ratio setpoint **SR**, as detailed above under 'Operating Modes' (page 4.67). **RT** must always lie in the range $-(HR - LR)$ to $+(HR - LR)$.

RT is a dimensionless number and its decimal point position is set by digit **A** of the **RA** parameter.

RB Ratio Bias

RB defines, in engineering units, the bias value added to the calculated ratio setpoint before it becomes the final **SR** parameter. Its decimal point position is set by the **ST** parameter, and it is ranged by the **PL** and **PH** parameters (refer to the **XPID** block section).

RCON: RATIO CONTROL BLOCK

Block Function

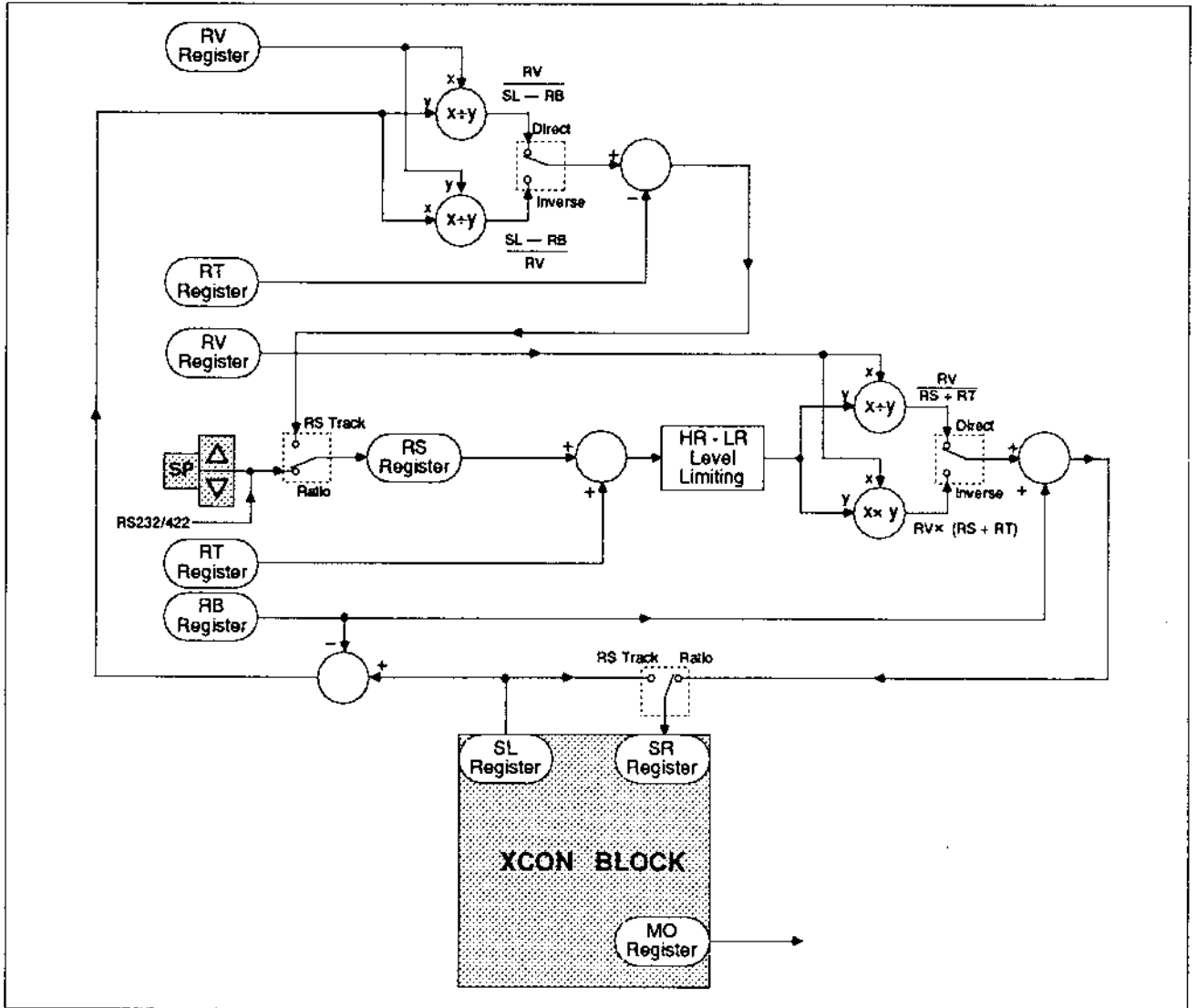

Figure 4.34 RCON Block Schematic

Please refer to Figure 4.34. The RCON Ratio Control block is basically an XCON Control block adapted to perform *ratio control* on a secondary process variable (RV). Under RATIO control the setpoint SR is essentially a direct or inverse *proportion* of a 'secondary' process variable input RV. The 'constant of proportionality' is the Ratio Setting parameter RS (trimmed by RT) and is adjustable via the front panel, control strategy, or either data link. This distinguishes RATIO from REMOTE control, where the setpoint is driven directly by an external signal.

The XCON block in the schematic is identical to the block shown in the section on the XCON Control block (Figure 4.28, page 4.59). Please refer to that section for a detailed description of the block function and parameters.

The remainder of the block schematic, involved with generating the ratio setpoint SR, is covered in the section on the RPID Ratio Control Block (page 4.66). Please refer to that section for details.

NOTE. In the RPID section, you should read 'RCON' instead of 'RPID' when applying the discussion to the RCON block.

Block Connections

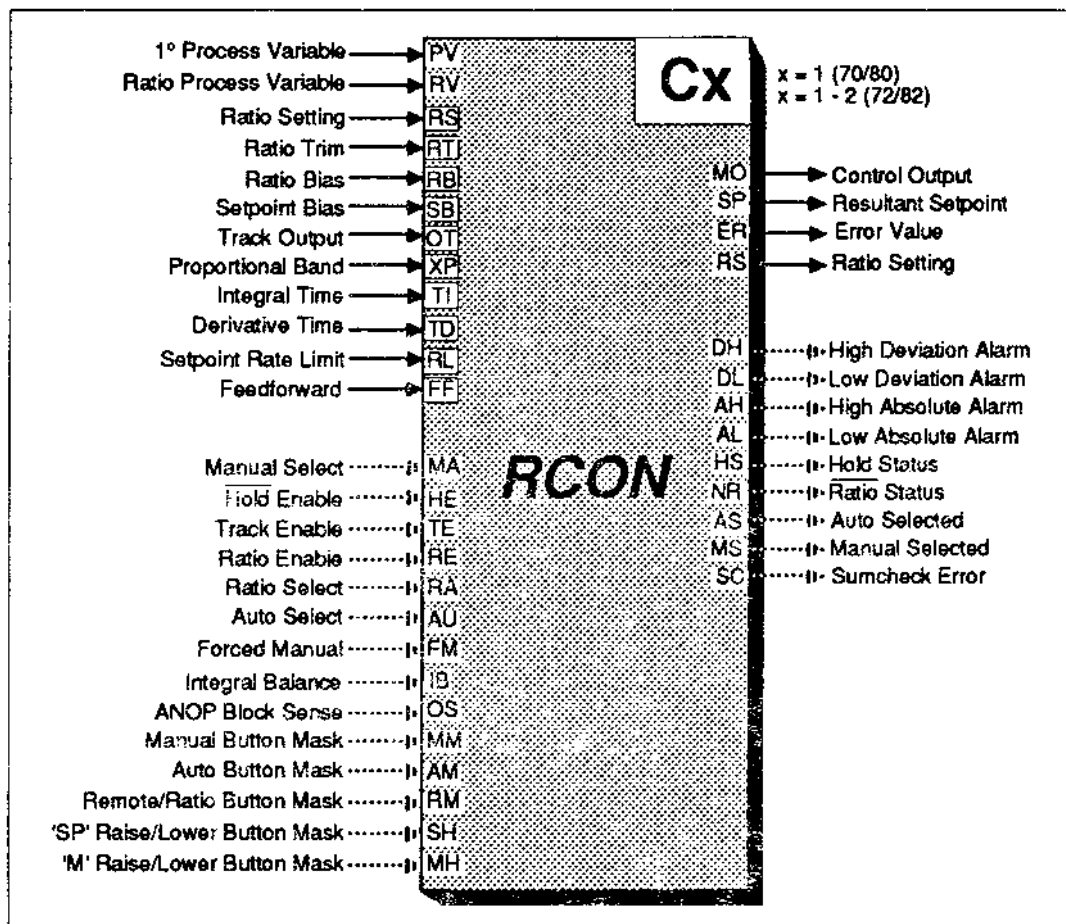

Figure 4.35 RCON Block Connections

Figure 4.35 represents all the RCON blocks in the instrument (one or two blocks depending on model). Each block has its own parameter set and can be installed at its own address. (Control Block Addresses: see Notes 1 and 2 on page 4.2.)

Incoming Connections. The connections coming into the RCON block are summarised in Table 4.33.

Code	Connection	Function	Format*
PV	1° Primary Process	The controlled variable. Scaled by PH, PL	FP
RV	Ratio Process Variable	The secondary (wild) variable.	FP
RS	Ratio Setting	Used to calculate ratio setpoint SR	FP
RT	Ratio Trim	Trim value added to RS before generation of SR.	FP
RB	Ratio Bias	Bias value added to calculated ratio setpoint before it becomes SR parameter. Scaled by PH, PL	FP
SB	Setpoint Bias	Bias added to SL to form SP	FP
OT	Track Output	Updates OP register when control loop is in OP TRACK mode	FP
XP	Proportional Band	Reciprocal of PID loop overall gain, expressed as percentage	FP
TI	Integral Time	Time constant (TI) used in PID calc.	FP
TD	Derivative Time	Time constant (TD) used in PID calc.	FP
RL	Setpoint Rate Limit		FP
FF	Feedforward	Bias added to result of PID calc.	FP
MA	Manual Select	Logic 1 selects MANUAL mode	0/1
HE	Hold Enable	Logic 0 enables HOLD mode	0/1
TE	Track Enable	Logic 1 enables OT TRACK mode	0/1
RE	Ratio Enable	Logic 1 enables RATIO mode	0/1
RA	Ratio Select	Logic 1 selects RATIO mode	0/1
AU	Auto Select	Logic 1 selects AUTO mode	0/1
FM	Forced Manual	Logic 1 selects FORCED MANUAL	0/1
IB	Integral Balance	Logic 1 triggers integral balance	0/1
OS	ANOP Block Sense	Logic 0 signifies direct O/P set Logic 1 signifies inverse O/P set (Sets ES parameter bit 4)	0/1
MM	Manual Button Mask	Logic 1 disables 'M' button	0/1
AM	Auto Button Mask	Logic 1 disables 'A' button	0/1

RM	Remote/Ratio Button Mask	Logic 1 disables 'R' button	0/1
SH	'SP' Raise/Lower Button Mask	Logic 1 disables 'SP' Δ / ∇ Buttons	0/1
MH	'M' Raise/Lower Button Mask	Logic 1 disables 'M' Δ / ∇ Buttons	0/1

Table 4.33 RCON Incoming Connections

NOTE. PV and RV are the only inputs that *must* be connected to other blocks for their data sources. You can update other inputs via connections or via the Hand-Held Terminal or RS422 data link. Figure 4.35 shows this by 'boxing-in' the optional connections. However, if FM (Forced Manual) is unconnected the program starts up in FORCED MANUAL mode. As a fail-safe measure FM should be wired so that FORCED MANUAL takes over whenever a sumcheck error or other significant failure occurs. Connect, for example, the GENP block's common block sumcheck error output (CS), OR'd with open-circuit flags (OC or O3) from the ANIN block supplying PV.

NOTE. When *default mode* is not in use, the OS (Output Sense) output of the ANOP block must be connected to the OS input of the control block connected to its AO input. If this is not done the operation of fail-safe measures may be undefined.

Outgoing Connections. Table 4.34 summarises the outgoing connections from the RCON block, available for connecting to another block (or blocks).

Code	Connection	Function	Format*
MO	Control Output	Block output, limited by HV-LV, HL-LL, via manual station	FP
SP	Resultant Setpoint	Local Setpoint value (SL) after biasing and limiting	FP
ER	Error Value	PV - SP	FP
RS	Ratio Setting	Used to calculate ratio setpoint SR	FP
DH	High Deviation Alarm	Sets to 1 if PV-SP > HD	0/1
DL	Low Deviation Alarm	Sets to 1 if SP-PV > LD	0/1
AH	High Absolute Alarm	Sets to 1 if PV > HA	0/1
AL	Low Absolute Alarm	Sets to 1 if PV < LA	0/1
HS	Hold Status	Sets to 1 if HOLD mode active	0/1
NR	Ratio Status	Sets to 0 if RATIO mode active, 1 if RATIO mode inactive	0/1

AS	Auto Status	Sets to 1 if AUTO mode selected	0/1
MS	Manual Status	Sets to 1 if MANUAL mode selected	0/1
SC	Sumcheck Error	Latches to 1 on sumcheck failure	0/1

Table 4.34 RCON Outgoing Connections

Block Parameters

Table 4.35 lists the RCON parameters and the units or format in which they are expressed.

Mnemonic	Parameter	Format*
ST	Block Status	HHHH
PH	Setpoint & PV High Range	±Eng.
PL	Setpoint & PV Low Range	±Eng.
HS	Setpoint High Limit	±Eng.
LS	Setpoint Low Limit	±Eng.
HA	High Absolute PV Alarm	±Eng.
LA	Low Absolute PV Alarm	±Eng.
HD	High Deviation Alarm	Eng.
LD	Low Deviation Alarm	Eng.
SL	Local Setpoint	±Eng.
SB	Setpoint Bias	±Eng.
ER	Error (PV – SP)	±Eng.
RL	Setpoint Rate Limit	±Eng./s
3T	PID Status	HHHH
XP	Proportional Band Constant	1000%
TI	Integral Time Constant	100
TD	Derivative Time Constant	100
TS	Algorithm Sampling Time	100
FF	Feedforward Term	±100%
SP	Resultant Internal Setpoint	±Eng.
ES	Enable Status	HHHH
MD	Loop Operating Mode	HHHH
SM	Front Panel Pushbutton Mask	HHHH
HV	Output Incremental Rate Limit	100%/s
LV	Output Decremental Rate Limit	100%/s
HL	High Output Limit	100%
LL	Low Output Limit	100%
MO	Control Output	100%
OP	Output Demanded	100%
OT	Output Track Value	100%
RA	Ratio Status	HHHH
HR	High Ratio Setting Limit	9999

*See Table 4.2 for an explanation of these formats

LR	Low Ratio Setting Limit	9999
RS	Ratio Setting	9999
RT	Ratio Trim	±9999
RB	Ratio Bias	±Eng.
SR	Ratio Setpoint	±Eng.
PV	Primary Process Variable	±Eng.
FC	Function Control Register	HHHH

Table 4.35 *RCON Block Parameters*

Most of the RCON block parameters (those above the line in Table 4.35) have functions corresponding exactly to the like-named parameters of the XCON block. Please refer to that section (page 4.60) for details.

NOTE. In the XCON section, you should read 'RCON' instead of 'XCON' in the parameter descriptions.

The other, ratio-related, RCON block parameters (below the line) have functions corresponding exactly to the like-named parameters of the RPID block. Please refer to that section (page 4.66) for details.

NOTE. In the RPID section, you should read 'RCON' instead of 'RPID' in the parameter descriptions.

*See Table 4.2 for an explanation of these formats

GENP: GENERAL PURPOSE BLOCK

Block Function

The General Purpose block (GENP) contains data on the overall operation of the Intelligent Loop Processor instrument, especially *error status* and *front panel status* information. GENP also holds instrument identity data, including 'dummy' data enabling certain supervisory systems to communicate with the instrument via its pseudo I/O blocks (6372 and 6382 only).

NOTE. Unlike other blocks, the GENP block output connections are updated not by the execution of the block but by the instrument maintenance routines.

Block Connections

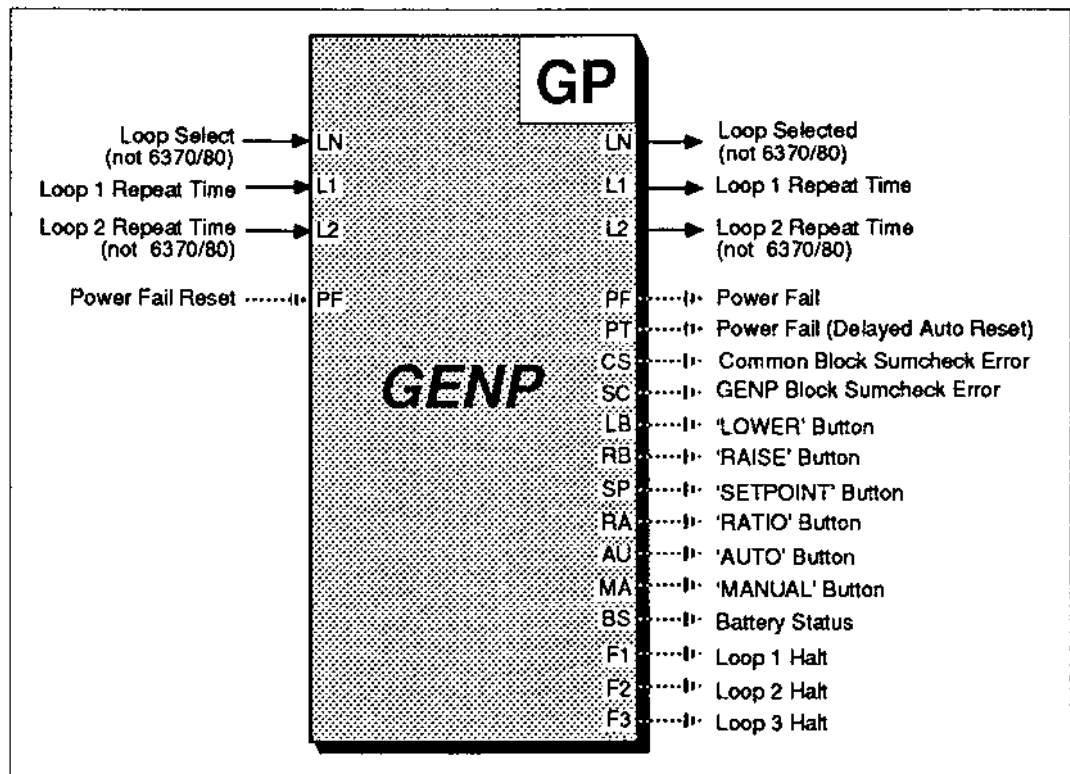

Figure 4.36 GENP Block Connections

Figure 4.36 represents the GENP block incoming and outgoing connections.

Outgoing Connections. Table 4.36 summarises the outgoing connections from the GENP block, available for connecting to another block (or blocks).

Code	Connection	Function	Format*
LN	Loop Selected (not 6370/80)	Indicates displayed loop (1, 2, 3)	FP
L1	Loop 1 Repeat Time	Interval (seconds) between successive starts of Loop 1 time-scheduled program	FP
L2	Loop 2 Repeat Time (not 6370/80)	Interval (seconds) between successive starts of Loop 2 time-scheduled program	FP
PF	Power Fail	Latches to 1 on power interruption or watchdog trip	0/1
PT	Power Fail (Delayed Auto Reset)	Sets to 1 on power interrupt or watchdog trip. When power re-stored, PT auto-resets 3 secs after one cycle of all loops completed	0/1
CS	Common Block Sumcheck Error	Sets to 1 on sumcheck failure of any instrument fixed block param. except Cn, Mn	0/1
SC	GENP Block Sumcheck Error	Latches to 1 on sumcheck failure of any GENP block parameter	0/1
LB	'LOWER' Button	Sets to 1 whilst 'LOWER' (∇) button pressed	0/1
RB	'RAISE' Button	Sets to 1 whilst 'RAISE' (Δ) button pressed	0/1
SP	'SETPOINT' Button	Sets to 1 whilst 'SETPOINT' (SP) button pressed	0/1
RA	'RATIO' Button	Sets to 1 whilst 'RATIO' (R) button pressed	0/1
AU	'AUTO' Button	Sets to 1 whilst 'AUTO' (A) button pressed	0/1
MA	'MANUAL' Button	Sets to 1 whilst 'MANUAL' (M) button pressed	0/1
BS	Battery Status	0 = O.K., 1 = Failed	0/1
F1	Loop 1 Halt	Sets to 1 on Loop 1 runtime error	0/1
F2	Loop 2 Halt	Sets to 1 on Loop 2 runtime error	0/1
F3	Loop 3 Halt	Sets to 1 on Loop 3 runtime error	0/1

Table 4.36 *GENP Outgoing Connections*

Incoming Connections. Table 4.37 summarises the connections coming into the GENP block.

Code	Connection	Function	Format*
LN	Loop Select (not 6370/80)	Selects displayed loop. 1≤LN<2: selects Loop 1 2≤LN<3: selects Loop 2 3≤LN<4: selects 'Display Mode' (LN<1 or ≥4: no action)	FP
L1	Loop 1 Repeat Time	Interval (seconds) between successive starts of Loop 1 time-scheduled program	FP
L2	Loop 2 Repeat Time (not 6370/80)	Interval (seconds) between successive starts of Loop 2 time-scheduled program	FP
PF	Power Fail Reset	Input logic 0 to reset PF output (logic 1 sets PF output)	0/1

Table 4.37 GENP Incoming Connections

Block Parameters

Table 4.38 lists the GENP parameters and the units or format in which they are expressed. *The parameters in the shaded area apply to 6372 and 6382 instruments only.*

Mnemonic	Parameter	Format*
ST	Block Status	HHHH
ID	Instrument Identity (read-only)	HHHH
II	Instrument Identity (read/write)	HHHH
PI	Program Identifier	HHHH
L1	Loop 1 Repeat Time (secs)	.1-999.9
L2	Loop 2 Repeat Time (secs)	.1-999.9
SI	6432 Instrument ID	HHHH
AA	6432 I/O Block Alarm	HHHH
P1 to P8	Pseudo Comms. Setup	HHHH
FC	Function Control Register	HHHH

Table 4.38 GENP Block Parameters

Each of these parameters is covered in more detail below.

*See Table 4.2 for an explanation of these formats

** Read-only fixed string values

ST Block Status

Figure 4.37 shows the meanings of the hexadecimal digits in the ST parameter of the General Purpose block. (The symbols used in the parameter diagram are explained in Figure 4.2.)

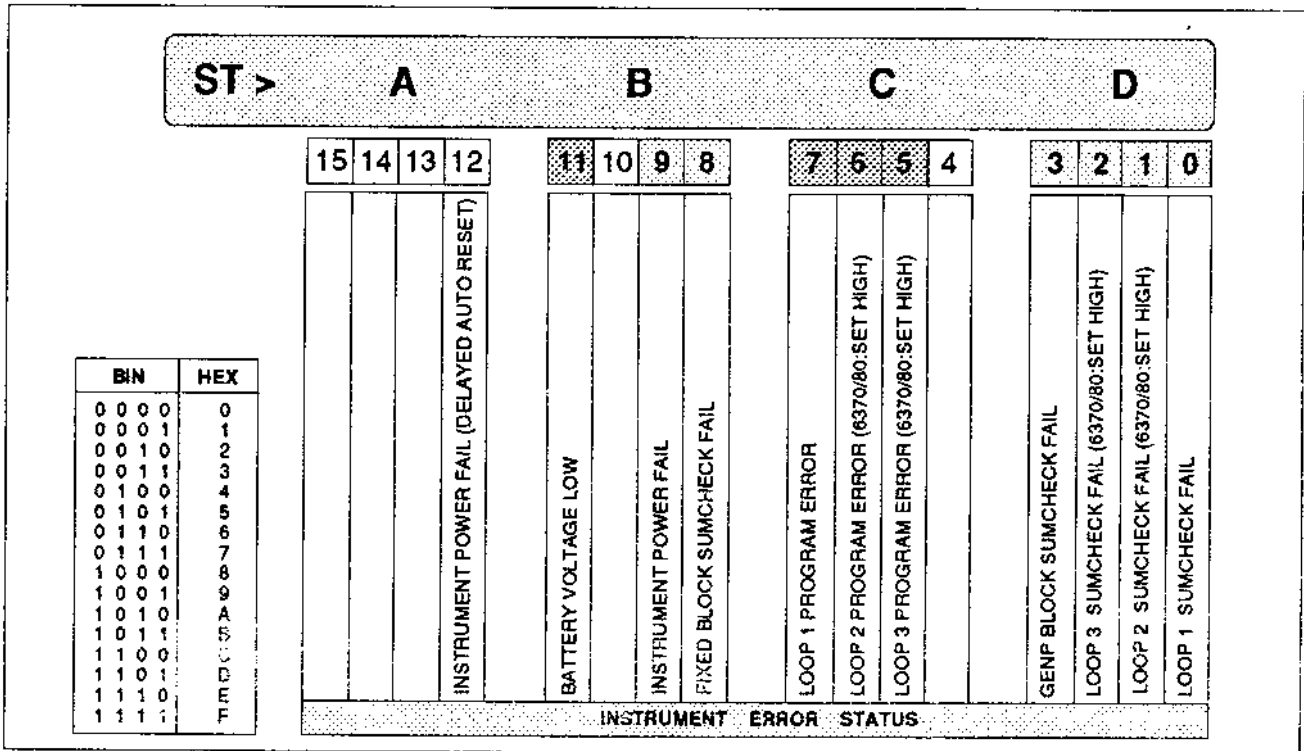

Figure 4.37 ST Parameter — General Purpose Block

Hardware Status — Digits A & B

Digits A & B tell you about hardware-related failures.

- **Instrument Power Fail (Delayed Auto Reset) — Bit 12.** This bit sets to logic 1 on power interruption or watchdog trip. When power is restored bit 12 remains high until after the last loop (Loop 3) has executed a single cycle. Then, after a further 3-second delay, bit 12 automatically resets to logic zero. (The block’s digital output connection PT follows bit 12.)

You can use Delayed Auto Reset to ensure that the control strategy does not start up until all initialisation and warmup routines have been completed.

- **Battery Voltage Low — Bit 11.** Sets to logic 1 if the battery voltage on the memory card drops below the level needed to guarantee non-volatility of the parameter memory area. Also, when this happens, the unused decimal points in the 4-digit display flash on and off, telling you to replace the battery.

Bit 11 is reset automatically by the CPU as soon as it detects that the battery voltage is at a safe level.

- **Instrument Power Fail — Bit 9.** Latches to logic 1 if any hardware reset or power failure is detected within the instrument, or if the FX recall parameter is used. This warns you that a power supply interruption, watchdog trip, or rewritten RAM, could have invalidated data in counters, totalisers, etc.

You must reset bit 9 to logic 0 via the Hand-Held Terminal, supervisory data link, or a user program.

- **Common Block Sumcheck Fail — Bit 8.** Sets to logic 1 whenever a sumcheck failure occurs in *any* of the fixed block parameters, including the GENP block itself but excluding Control and MANS blocks, even if the block is not involved in a control strategy. Bit 8 can be reset to logic 0 only when bit 3 of the faulty block's ST parameter has itself been reset to logic 0. Note that a sumcheck failure in a block allocated to a particular loop halts that loop.

Program Status — Digit C

Digit C tells you about runtime program-related errors.

- **Loop 1 Program Error — Bit 7.** Sets to logic 1 whenever a runtime error is detected in the time-scheduled Loop 1 program. Bit 7 resets to logic 0 only when the error has been corrected and the loop program restarted.
- **Loop 2 Program Error — Bit 6.** Sets to logic 1 whenever a runtime error is detected in the time-scheduled Loop 2 program. Bit 6 resets to logic 0 only when the error has been corrected and the loop program restarted. (6370/80: bit 6 defaults high, and is 'don't care'.)
- **'Loop 3' Background Program Error — Bit 5.** Sets to logic 1 whenever a runtime error is detected in the 'Loop 3' background program. Bit 5 resets to logic 0 only when the error has been corrected and the background program restarted. (6370/80: bits 5 and 6 default high, and are 'don't care'.)

NOTE. With *default mode* selected (switch 1 of switchbank 3 ON), if Loop 1 program halts (bit 7 high) the default ANOP block B4 can be driven directly by MANS block M1. If Loop 2 program halts (bit 6 high) ANOP block B3 can be driven directly by MANS block M2 (6372/82 only). To prevent bumping when the program first halts the manual station output is initialised to the analogue output value.

The block's digital outputs F1, F2, and F3 follow the values of ST bits 7, 6, and 5 respectively. All three bits, and the corresponding outputs, set initially at power up and then each resets to logic 0 on completion of the respective loop's first cycle.

Block Status — Digit D

- **Block Sumcheck Failure — Bit 3.** Automatically latches to logic 1 whenever the CPU detects a sumcheck failure in any of the parameters of the GENP block. To clear this condition, re-enter any corrupted parameters, and then write a zero to bit 3.

- **Loop Sumcheck Failures — Bits 2, 1, 0.** Bits 2, 1, and 0 latch to logic 1 whenever a sumcheck failure is detected in any of the parameters of the corresponding Loop, i.e. Loops 3, 2, and 1, respectively. To clear this condition, re-enter any corrupted parameters, and then write a zero to the appropriate bit.

NOTE. If Loop 1 (or 2) contains a control block and halts on runtime error, the control block automatically adopts FORCED MANUAL mode.

ID Instrument Identity (Read-Only)

ID is a read-only parameter telling you the instrument model number and software issue.

The first three (hexadecimal) digits are the product code (omitting the leading '6'), and the last digit is the software issue number. For example, ID>3823 means a model 6382 instrument with Issue 3 software installed.

II Instrument Identity (Read/Write)

II is a read/write parameter allowing you to change the functionality of the instrument, and/or its appearance to the communications of a supervisory computer system. II tells you the 'acting' identity of the instrument, and has exactly the same format as ID.

II and ID also appear in the Hand-Held Terminal Command Mode (?? CMD) list of parameters, which is described in Chapter 6. Please refer there for details.

PI Program Identifier

The read/write PI parameter is a user-defined 16-bit hexadecimal number in the range 0 to FFFF provided to identify uniquely the control strategy program. (PI can be downloaded from the *LoopDraw* configuration package.)

L1 & L2 Loop 1 & Loop 2 Repeat Times

L1 and L2 are the time intervals between successive initiations of loop 1 and loop 2 programs, respectively. They can have values from 0.1 to 999.9 seconds, fixed at one decimal place.

Whenever you switch on the instrument (or after a watchdog failure), L1 and L2 always adopt default values of 3.0 seconds. You can alter these values afterwards, via the Hand-Held Terminal, serial data link, or the control program itself (e.g. from a constants block). Do not (in general) connect to L1 or L2 if the loop contains a *control block*. This could interfere with the proper functioning of the task scheduler (see Chapter 9, *Task Scheduling*, for details).

SI, AA

'6432' Instrument Pseudo I/O Parameters

These are read-only 'dummy' parameters emulating the corresponding ones of the TCS System 6000 6432 Signal Processor. They enable supervisory computers whose communications systems cannot recognise Intelligent Loop Processors, but *can* recognise 6432s, to interface successfully with 6372 and 6382 instruments. The communications links must be via Pseudo Analogue and Digital I/O blocks (which emulate the 6432 I/O system).

For full details of the computer supervision of Intelligent Loop Processors, please refer to Chapter 8.

P1 to P8 Pseudo Comms Setup

Eight read-only parameters, one for each of the eight possible configured comms addresses (INOs), summarising the quantities and types of pseudo I/O channel enabled. Parameter values are automatically allocated to the P_n set, sequentially by INO-value, with P1 containing the lowest value. Any unused P_n parameters at the end of the list default to 0000. Addresses with no enabled channels do not appear. (See the *Example* at the end of this section.)

Figure 4.38 shows the meanings of the hexadecimal digits in the P1 to P8 parameters of the General Purpose block. (The symbols used in the parameter diagram are explained in Figure 4.2)

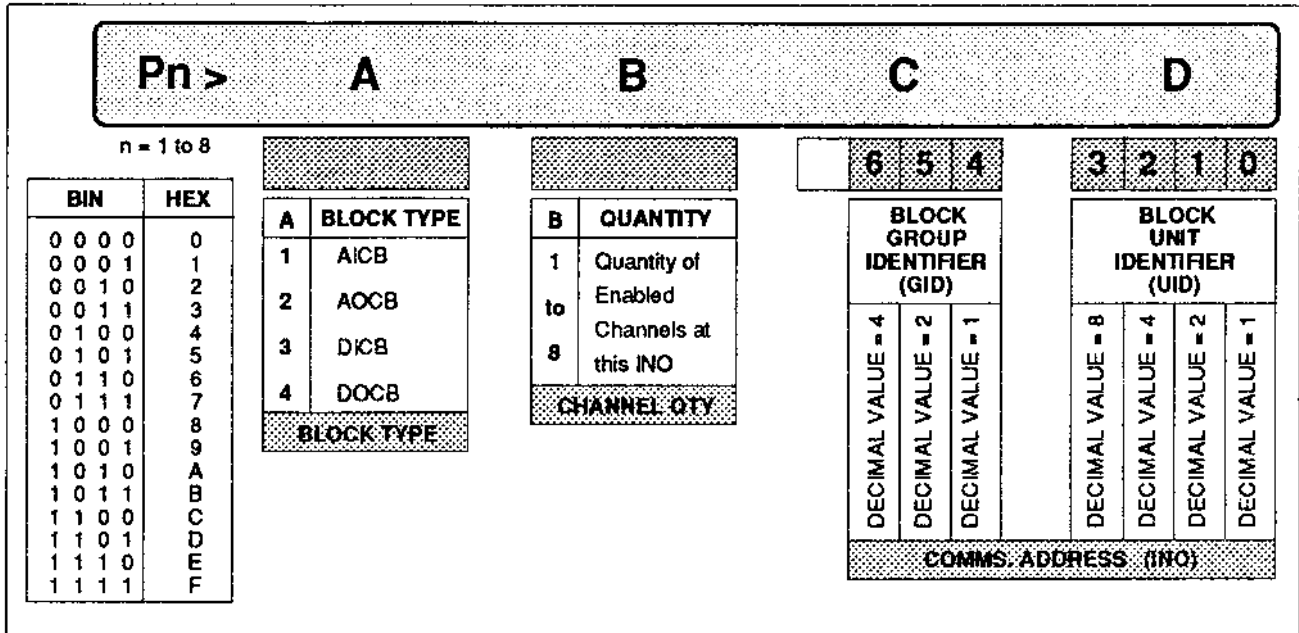

Figure 4.38 P1 to P8 Parameters (Pn) — General Purpose Block

Block Type — Digit A

Read-only digit A indicates the pseudo I/O block type enabled at the address shown by digits C and D: 1=AICB, 2=AOCB, 3=DICB, and 4=DOCB. Only one type of pseudo block can be enabled at a given address.

Channel Quantity — Digit B

Read-only digit B shows the quantity of channels enabled (i.e. with bit 7 of their IN parameters at logic 1) at the address shown by digits C and D. Digit B is in the range 1 to 8 for the single-channel AICB and AOCB blocks, but is always 8 for the 8-channel DICB and DOCB blocks.

Communications Address (INO) — Digits C & D

Read-only digits C and D together specify INO, the Instrument Number accommodating the block type shown by digit A.

FIXED BLOCKS

- **Block Group Identifier (GID) — Bits 6 to 4.** Three bits showing the block GID (in the range 0 to 7).
- **Block Unit Identifier (UID) — Bits 3 to 0.** Four bits showing the block UID (in the range 0 to 15).

The decimal value of INO is calculated as $INO_{dec} = (16 \times GID_{dec}) + UID_{dec}$.
The hexadecimal value of INO is simply $INO_{hex} = CD$.

Example *Four addresses configured and enabled:*

P1>1800	8 pseudo analogue inputs (AICBs) at INO address 0
P2>1801	8 pseudo analogue inputs (AICBs) at INO address 1
P3>2507	5 pseudo analogue outputs (AOCBs) at INO address 7
P4>4815	8 pseudo digital outputs (DOCB) at INO address 15_{hex} (21_{dec})
P5>0000	(unused)
P6>0000	(unused)
P7>0000	(unused)
P8>0000	(unused)

FC Function Control Register

The FC parameter is explained on page 4.19. Please refer there for details.

LLAG: LEAD/LAG (FILTER) BLOCK

Block Function

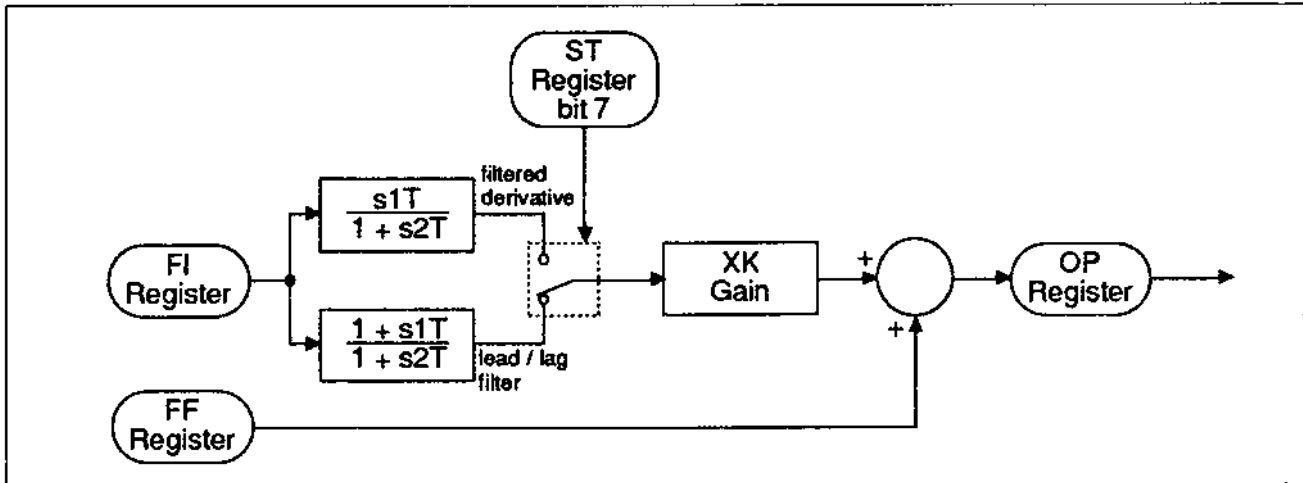

Figure 4.39 Lead/Lag (Filter) Block Schematic

Please refer to Figure 4.39. The LLAG block provides a lead/lag filter for use in feed-forward computations, or for setting up plant models.

Normal Operation. In normal operation (ST bit 7 set to logic 0) as a conventional lead/lag filter, the LLAG block output OP and input FI are related by

$$L(OP) = XK \left(\frac{1 + s1T}{1 + s2T} \right) L(FI) + L(FF)$$

where XK = overall filter gain

1T, 2T = lead, lag time constants resp. (sec or min)

FF = bias added before output.

s = Laplace Transform Operator d()/dt

L (variable) = Laplace Transform of variable

Filtered Derivative. With ST bit 7 set to logic 1, the DC gain becomes zero and OP is now a filtered derivative characteristic:

$$L(OP) = XK \left(\frac{s1T}{1 + s2T} \right) L(FI) + L(FF)$$

Block Connections

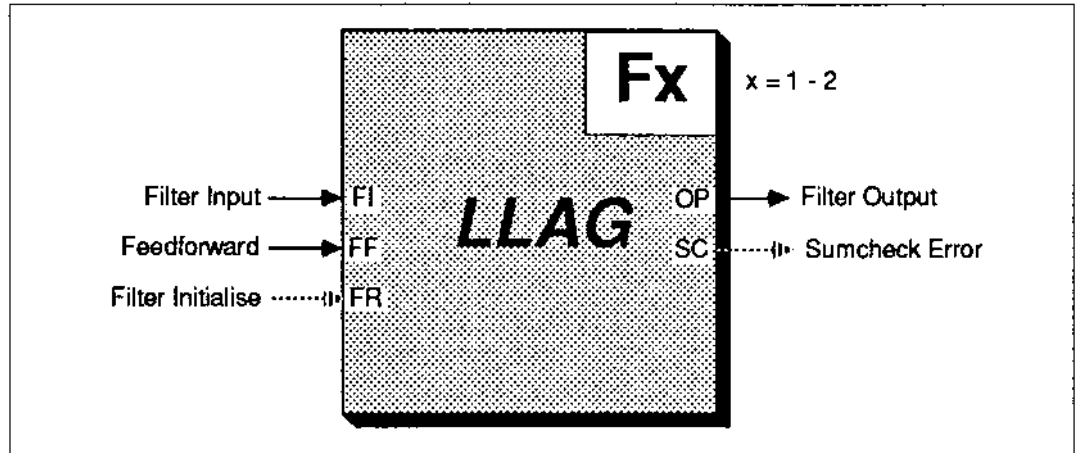

Figure 4.40 LLAG Block Connections

Figure 4.40 represents both the LLAG blocks in the instrument (6372/82 only). Each block has its own address and parameter set.

Incoming Connections. The connections coming into the LLAG block are summarised in Table 4.39.

Code	Connection	Function	Format*
FI	Filter Input	Input to lead/lag filter block	FP
FF	Feedforward/ Output Bias	Bias added to filter calculation before becoming output OP	FP
FR	Filter Initialise	Sets ST bit 6, causing (FI + FF) value to be copied directly to OP	0/1

Table 4.39 LLAG Incoming Connections

Outgoing Connections. Table 4.40 summarises the outgoing connections from the LLAG block.

Code	Connection	Function	Format*
OP	Filter Output	Block output. (Initialised by setting ST bit 6)	FP
SC	Sumcheck Error	Latches to 1 on sumcheck failure	0/1

Table 4.40 LLAG Outgoing Connections

*See Table 4.2 for an explanation of these formats

Block Parameters

Table 4.41 lists the LLAG parameters and the units or format in which they are expressed.

Mnemonic	Parameter	Format*
ST	Block Status	HHHH
XK	Filter Gain	± 100
1T	Lead Filter Time Constant	100
2T	Lag Filter Time Constant	100
FF	Feedforward/ Output Bias	$\pm 100\%$
FI	Filter Input	100%
OP	Filter Output	100%
FC	Function Control Register	HHHH

Table 4.41 LLAG Block Parameters

Each of these parameters is covered in more detail in the sections that follow.

ST Block Status

Figure 4.41 shows the meanings of the hexadecimal digits in the ST parameter of the Lead/Lag (Filter) block. (The symbols used in the parameter diagram are explained in Figure 4.2.)

Filter Operating Mode — Digits B & C

- **Time Constant Units — Bit 8.** Determines the units of the two filter time constants, 1T and 2T. Logic 0 selects seconds, and logic 1 selects minutes.
- **Filtered Derivative Select — Bit 7.** Logic 0 selects a conventional lead/lag filtering action for the block. Logic 1 modifies the characteristic to a filtered derivative, with the DC gain zero. The equations for these filters are given on (page 4.94).
- **Filter Initialise — Bit 6.** Bit 6 initialises the filter by transferring the current input value plus bias (FI + FF) directly to the output parameter OP.

Whenever bit 6 is set to logic 1 via Hand-Held Terminal or RS422 link OP is set the next time the LLAG block is executed. Bit 6 then automatically resets to logic 0.

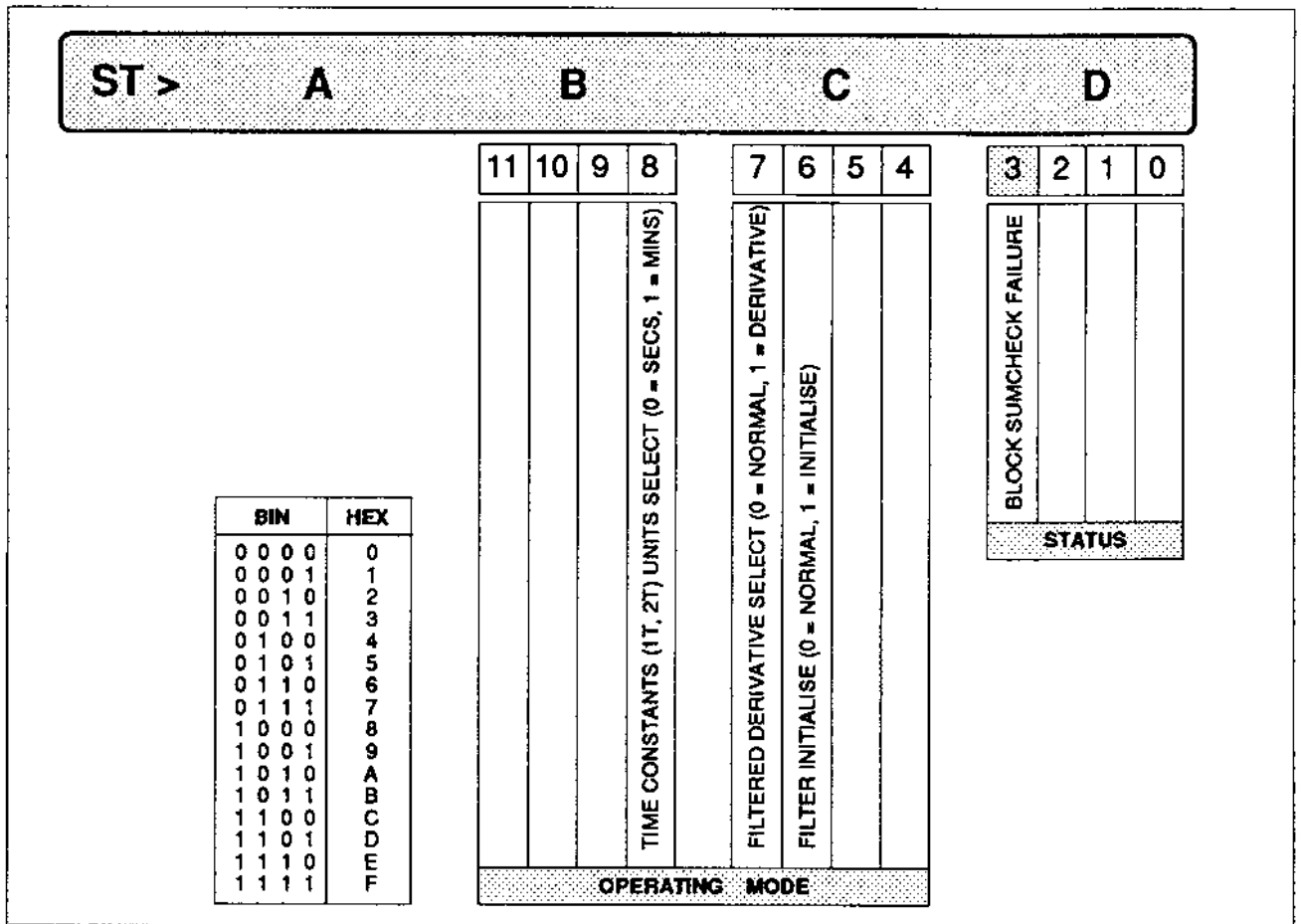

Figure 4.41 ST Parameter — Lead/Lag (Filter) Block

Block Status — Digit D

Bit 3 of digit D automatically latches to logic 1 whenever the CPU detects a sumcheck failure in any of the parameters of the LLAG block. To clear this condition, re-enter any corrupted parameters, and then write a zero to bit 3.

XK Filter Gain

XK is the overall gain of the filter, defined in the equations given on (page 4.94).

1T & 2T Filter Time Constants

These define the values of the lead and lag time constants, respectively, in the filter equations given on (page 4.94). Their units are set by bit 8 of the ST parameter: logic 0 sets *seconds*, and logic 1 sets *minutes*.

A value of 00.00 (seconds or minutes) sets either of the terms off completely.

FF Feedforward / Output Bias

FF defines the bias value added in the filter equation (page 4.94) before the result is passed to the filter output OP.

FI Filter Input

FI is the current value of the Lead/Lag (Filter) block input. A control strategy usually links FI to the output of another block, such as an Analogue Input or PID Control block.

OP Filter Output

OP is the output of the Lead/Lag (Filter) block, derived by adding the Output Bias term FF to the filtered input value. This is defined by the equations given on page 4.94. Whenever bit 6 of the ST parameter is set, the filter is initialised by transferring the current value of $FI + FF$ directly to OP.

A control strategy usually links OP to the input of another block, such as an Analogue Output, Manual Station, or PID Control block.

FC Function Control Register

The FC parameter is explained on page 4.19. Please refer there for details.

DTIM: DEADTIME BLOCK

Block Function

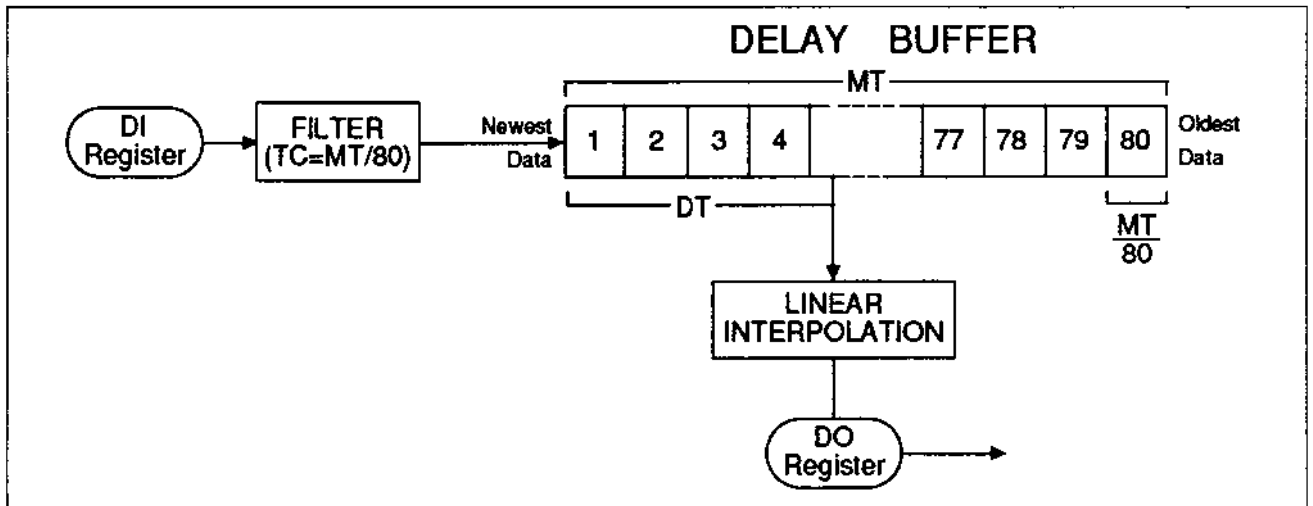

Figure 4.42 *Deadtime Block Schematic*

Please refer to Figure 4.42. The DTIM block is used to implement a time delay within a control strategy.

Deadtime Block Buffer. The MT parameter defines the *maximum* delay that you will require (up to 9999 sec), and sets up a delay buffer MT seconds long, divided into 80 equal time segments.

The DI parameter holds the current value of the input to the block, which is first-order filtered (time constant MT/80) and placed into the head of the buffer, once every MT/80 seconds.

DT, the Delay Time parameter, defines the *actual* time delay between the block output DO and the block input DI. DO is updated from a point DT seconds along the buffer. If the required data point lies between two of the 80 buffer points, DO is estimated by linear interpolation.

Delay Initialisation. Initialising the deadtime block consists of making all the delay buffer elements equal to the current input value DI. You can do this by setting bit 6 of the ST parameter to logic 1, or by setting the Delay Reset digital input (DR) to logic 1. The buffer is also initialised whenever the value of MT is altered.

Block Connections

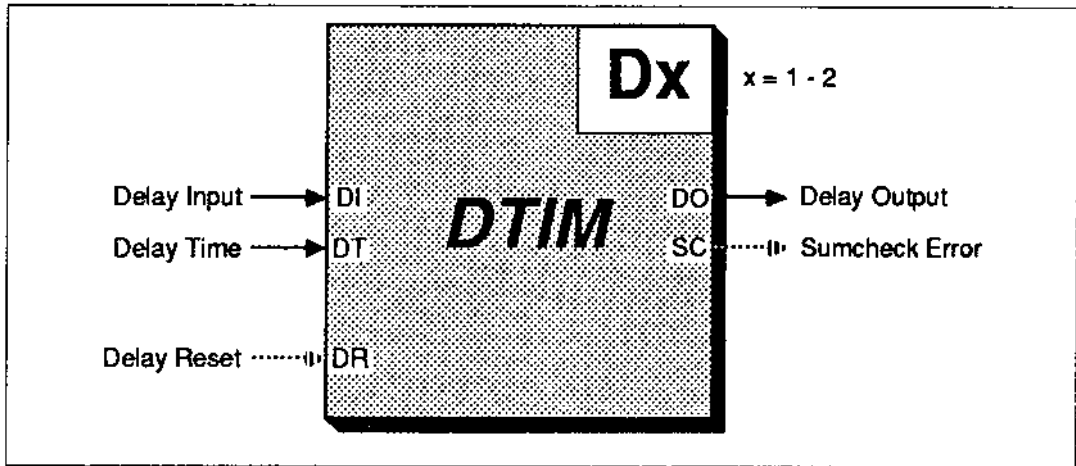

Figure 4.43 DTIM Block Connections

Figure 4.43 represents both the DTIM blocks in the instrument (6372/82 only). Each block has its own address and parameter set.

Incoming Connections. The connections coming into the DTIM block are summarised in Table 4.42.

Code	Connection	Function	Format*
DI	Delay Input	Input to Delay block	FP
DT	Delay Time (actual)	Time lag (secs) between DO & DI	FP
DR	Delay Reset	Initialises Delay Block	0/1

Table 4.42 DTIM Incoming Connections

Outgoing Connections. Table 4.43 summarises the outgoing connections from the DTIM block.

Code	Connection	Function	Format*
DO	Delay Output	Block output	FP
SC	Sumcheck Error	Latches to 1 on sumcheck failure	0/1

Table 4.43 DTIM Outgoing Connections

Block Parameters

Table 4.44 lists the DTIM parameters and the units or format in which they are expressed.

Mnemonic	Parameter	Format*
ST	Block Status	HHHH
MT	Maximum Delay Time (secs)	Eng.
DT	Delay Time (secs)	Eng.
FC	Function Control Register	HHHH

Table 4.44 DTIM Block Parameters

Each of these parameters is covered in more detail in the sections that follow.

ST Block Status

Figure 4.44 shows the meanings of the hexadecimal digits in the ST parameter of the Deadtime block. (The symbols used in the parameter diagram are explained in Figure 4.2.)

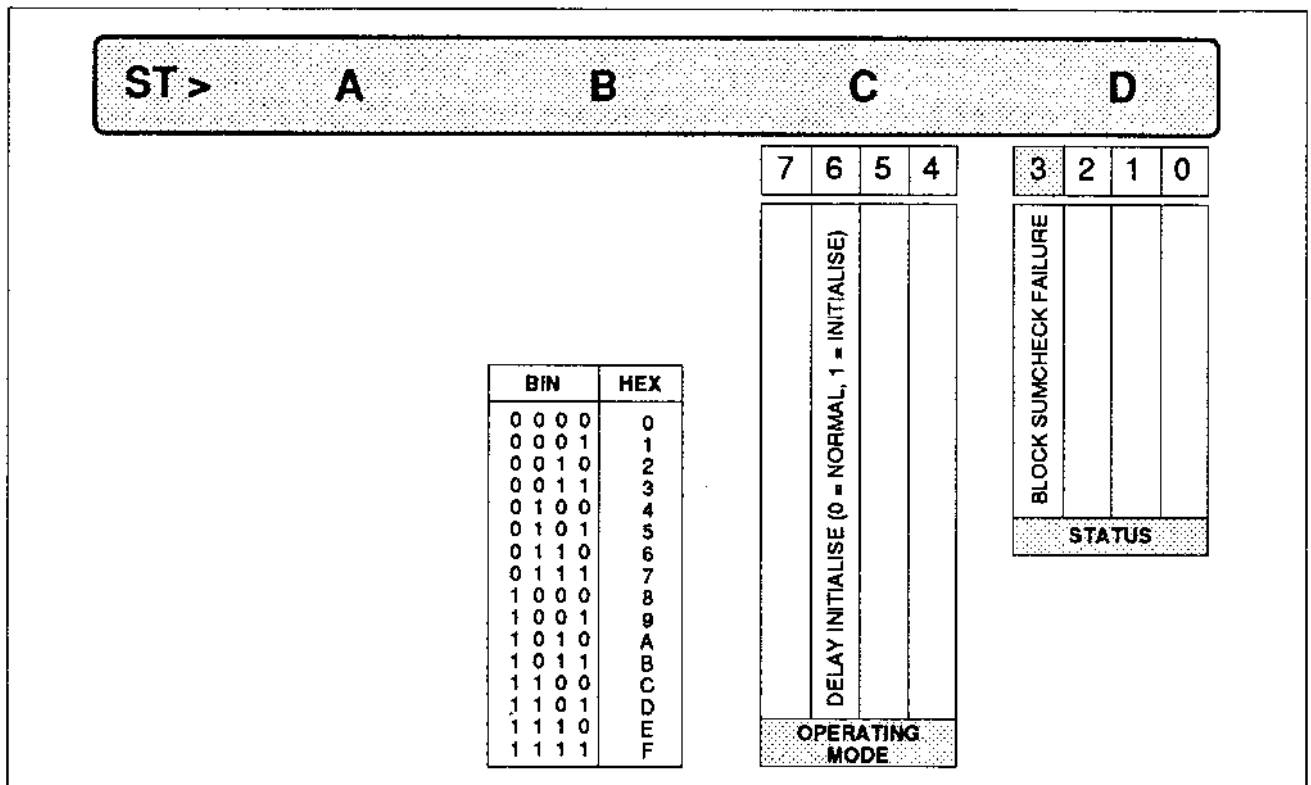

Figure 4.44 ST Parameter — Deadtime Block

*See Table 4.2 for an explanation of these formats

Delay Operating Mode — Digit C

Delay Initialise — Bit 6. Bit 6 initialises the block by making all entries in the delay buffer equal to the most recent value of DI.

When bit 6 is set to logic 1, the buffer entries are equalised the next time the DTIM block is executed. Bit 6 then automatically resets to logic 0.

Block Status — Digit D

Bit 3 of digit D automatically latches to logic 1 whenever the CPU detects a sumcheck failure in any of the parameters of the DTIM block. To clear this condition, re-enter any corrupted parameters, and then write a zero to bit 3.

MT Maximum Delay Time

The MT parameter specifies the maximum value of the time delay (DT) obtainable with the DTIM block. It does this by defining the delay buffer length (seconds).

MT also defines the first order filter time constant (equal to $MT/80$) that is applied to the block input, as well as the resolution of the signal held in the 80-point buffer (points are $MT/80$ apart). You should therefore set MT no larger than needed to get the required signal time delay (DT).

DT Delay Time

The DT parameter defines the actual time delay between DO and DI. DO is updated from a point DT seconds along the buffer. If the required data point lies between two of the 80 buffer points, DO is estimated by linear interpolation.

FC Function Control Register

The FC parameter is explained on page 4.19. Please refer there for details.

TOTL: TOTALISATION BLOCK

Block Function

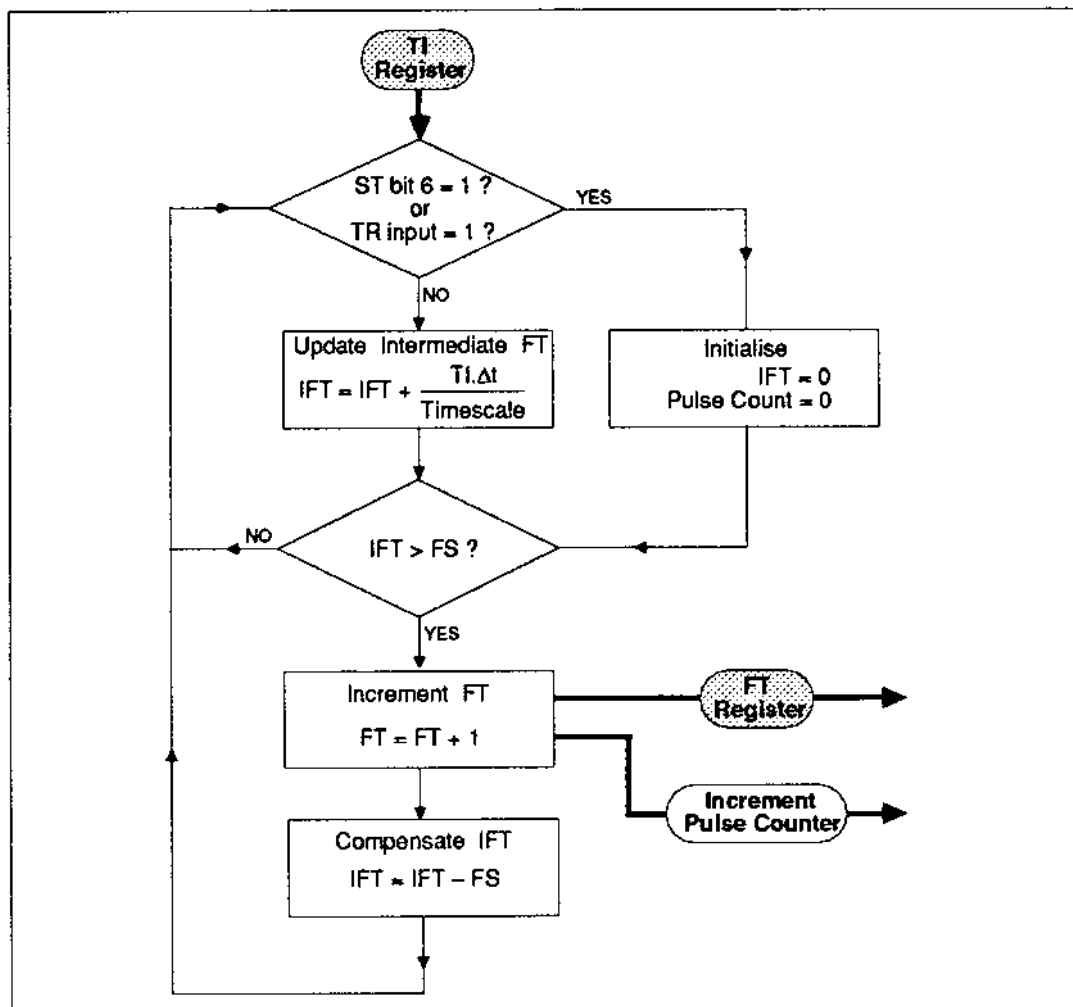

Figure 4.45 Totalisation Block Schematic

The TOTL block is used in a control strategy to totalise a variable. Please refer to the flow diagram in Figure 4.45.

Intermediate Flow Total. The TI parameter holds the current value of the variable to be totalised. Once every loop scan time Δt (provided the initialisation bit has not been set) the quantity that has flowed in the last Δt seconds is calculated from TI, and this quantity is added to an 'Intermediate Flow Total' IFT. Digit D of the ST parameter sets the timescale (seconds, minutes, hours, or days) for the calculation.

Flow Scaling & Flow Total Parameters. The Flow Scaling factor parameter (FS) specifies the quantity of flow required to increase the Flow Total parameter (FT) by one count and to increase the Pulse Counter by one pulse. Each time the loop is scanned, if IFT is greater than FS, the flow total FT and Pulse Counter are incremented (by one count only), and IFT reduced accordingly.

Pulse Output. The block's digital Pulse Output TP emits one pulse for every increment of the FT parameter.

A complete 'pulse' consists of a logic 1 held for one loop scan time followed by a logic 0 held for one loop scan time. It therefore takes twice as long to emit a pulse as it does to increment FT, which takes only one loop scan time. Because of this the pulse output can fall behind FT when the total is increasing rapidly; but no pulses are lost and the total 'catches up' again during low-flow periods.

NOTE. Please refer to the individual parameter details for more information.

Flow Total Initialisation. If the initialisation bit in the ST parameter (or the TR block input) has been set to logic 1, IFT is set to zero instead of recalculated. The flow total parameter FT, and the Pulse Count, are also zeroed.

Block Connections

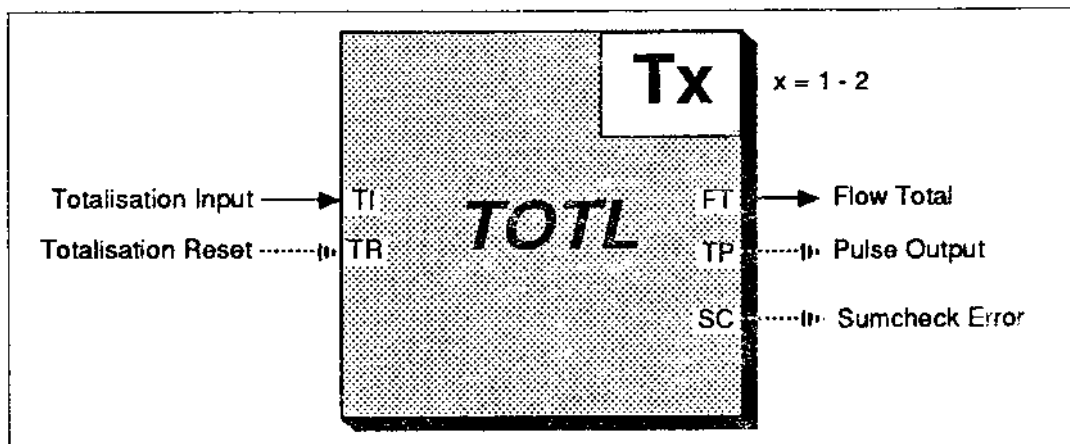

Figure 4.46 *TOTL Block Connections*

Figure 4.46 represents both the TOTL blocks in the instrument (6372/82 only). Each block has its own address and parameter set.

CAUTION. If you connect the TOTL block's digital pulse output TP to another block, both blocks should be in the *same loop* to avoid data loss due to loop scheduling mismatches. Also, if you use a Digital Output block (DGOP) to output the pulses, it may be unwise to choose Loop 3 for this purpose. (Refer to Chapter 9, *Task Scheduling*, for details.)

Incoming Connections. The connections coming into the TOTL block are summarised in Table 4.45.

Code	Connection	Function	Format*
TI	Totalisation Input	Input to Totalisation block	FP
TR	Totalisation Reset	Logic 1 resets IFT, FT, Pulse Counter	0/1

Table 4.45 *TOTL Incoming Connections*

Outgoing Connections. Table 4.46 summarises the outgoing connections from the TOTL block.

Code	Connection	Function	Format*
FT	Flow Total	Analogue Block output.	FP
TP	Pulse O/P	Pulse Block Output	0/1
SC	Sumcheck Error	Latches to 1 on sumcheck failure	0/1

Table 4.46 *TOTL Outgoing Connections*

Block Parameters

Table 4.47 lists the TOTL parameters and the units or format in which they are expressed.

Mnemonic	Parameter	Format*
ST	Block Status	HHHH
FS	Flow Scaling Factor	1000
FT	Flow Total	9999
FC	Function Control Register	HHHH

Table 4.47 *TOTL Block Parameters*

Each of these parameters is covered in more detail in the sections that follow.

*See Table 4.2 for an explanation of these formats

ST Block Status

Figure 4.47 shows the meanings of the hexadecimal digits in the ST parameter of the Totalisation block. (The symbols used in the parameter diagram are explained in Figure 4.2.)

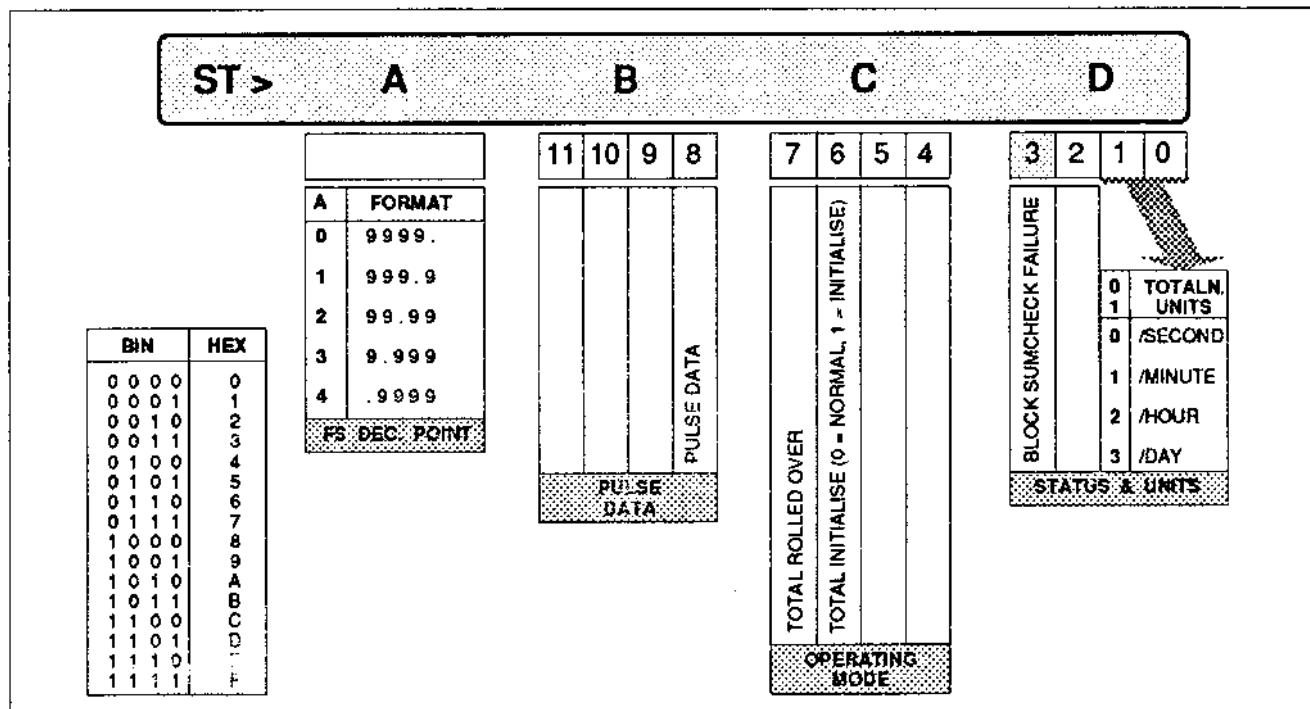

Figure 4.47 ST Parameter — Totalisation Block

FS Decimal Point — Digit A

Digit A sets the number of decimal places for the FS parameter (engineering units).

Pulse Data — Digit B

Bit 8 of digit B determines the state of the block's Pulse Output TP. It goes through a pulse cycle every time the Flow Total parameter FT increases by one count (high for 1 loop scan time, then low for 1 loop scan time). The normal state of bit 8 when pulses are not being emitted is logic 0.

Totalisation Operating Mode — Digit C

- Total Roll-Over — Bit 7.** If you let the Flow Total parameter FT reach its maximum of 9999 it automatically 'rolls over' through zero, and totalisation continues uninterrupted. To warn you that this has happened, bit 7 sets to logic 1 from its normal state, logic 0.

- **Totalisation Initialise — Bit 6.** Normally (bit 6 at logic 0), the Intermediate Flow Total IFT is updated once per loop cycle time with any flow that has occurred during that time. Please refer to the block schematic in Figure 4.45.

If you set bit 6 to logic 1, IFT is instead *initialised* by being reset to zero, and bit 6 automatically resets to logic 0. Inputting a logic 1 via the block's TR (Totalisation Reset) digital input also initialises IFT.

NOTE. The FT parameter and the Pulse Count are also reset to zero with IFT.

Block Status & Units Select — Digit D

- **Sumcheck Fail — Bit 3.** Bit 3 of digit D automatically latches to logic 1 whenever the CPU detects a sumcheck failure in any of the parameters of the TOTL block. To clear this condition, re-enter any corrupted parameters, and then write a zero to bit 3.
- **Units Select — Bits 1, 0.** You set these bits to the time units (per second, per minute, per hour, or per day) of the input variable being totalised, TI. This information determines the timescale in the flow calculation updating the Intermediate Flow Total IFT (see Figure 4.45).

FS Flow Scaling Factor

The FS parameter specifies the quantity of flow required to increase the Flow Total parameter (FT) and the Pulse Counter by one count. For example, if the incoming flow rate is litres per minute and you want FT to count in 50-litre lots, set FS to 50 and ST bit 0 to 1.

Each time the loop is scanned, if IFT is greater than FS, the flow total FT is incremented, and IFT reduced accordingly.

NOTE. FT can be increased by only *one* count every loop cycle, however much flow has accumulated in IFT. This means that you must set the value of FS high enough, and/or the loop must cycle fast enough, if you want FT to keep up with the true flow total. If FT does fall behind, however, it will 'catch up' again during low flow periods.

FT Flow Total

The Flow Total parameter FT is incremented every time the intermediate flow total exceeds the Flow Scaling parameter FS. You select the totalisation units by the value chosen for FS, as well as by digit A of the ST parameter.

If FT reaches its maximum value of 9999 it 'rolls over' through 0000 and continues totalising without interruption. The 'total roll-over' flag in digit C of the ST parameter sets to logic 1 to warn you that this has happened.

(For more information, please refer to the previous section on the FS parameter, and to the block schematic in Figure 4.45.)

FC Function Control Register

The FC parameter is explained on page 4.19. Please refer there for details.

DISP: DISPLAY BLOCK

Block Function

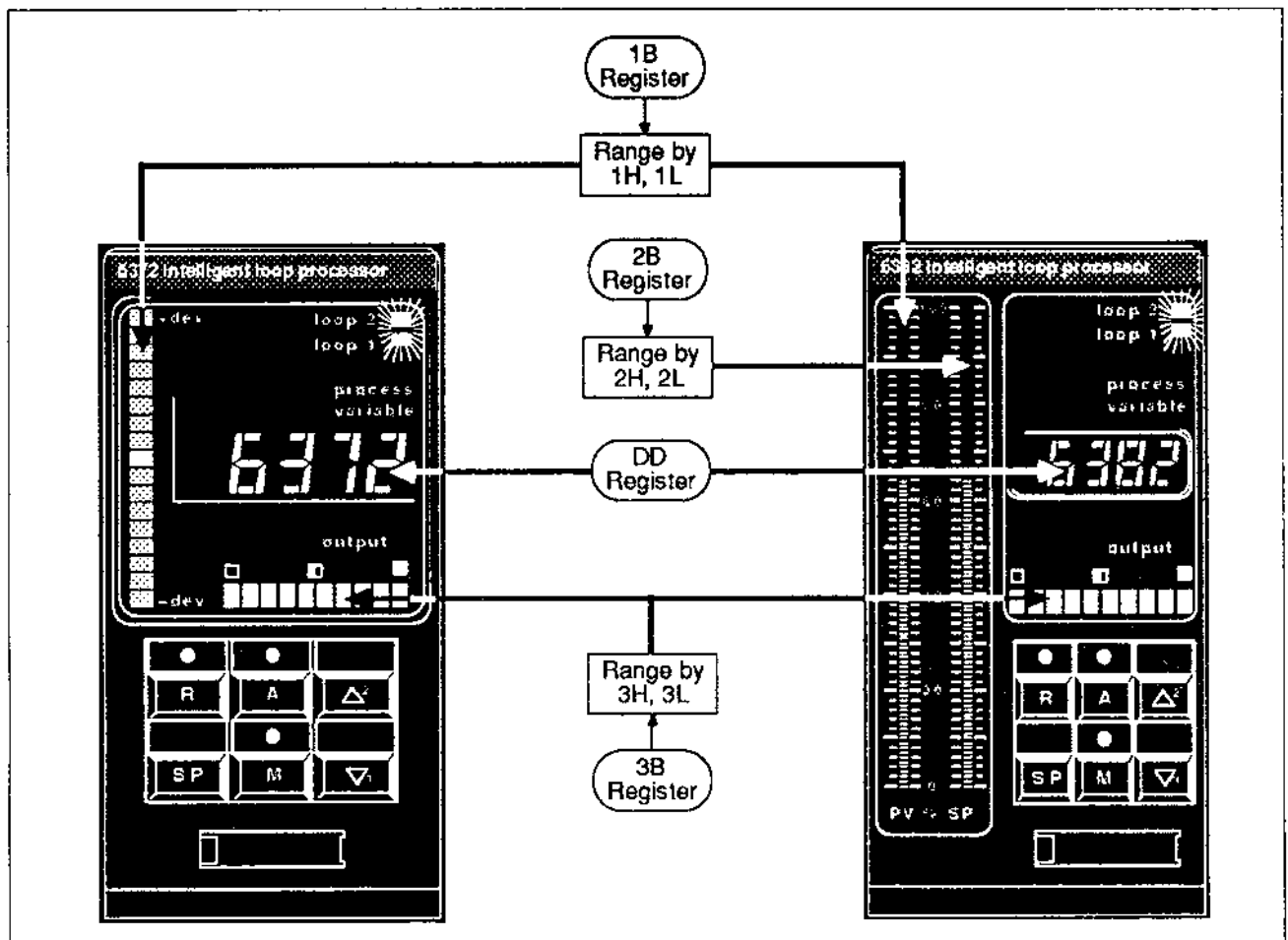

Figure 4.48 Display Block Schematic

The DISP block lets you assign the instrument front panel displays to analogue or digital variables in a control strategy. Please see Figure 4.48.

Display Mode. In normal operation, with only one of the two loop mode indicator lamps lit, the displays and pushbuttons function normally as indicated by their labels. If you press both loop select buttons (Δ^2 & ∇_1) together, both lamps light and you enter *display mode*. Now, pressing the pushbuttons has no effect (unless you have assigned them special functions via the GENP block digital outputs), and the displays are driven by the contents of the four DISP block registers: 1B, 2B, 3B, and DD.

Press either of the loop select buttons to exit display mode and return the push-buttons and displays to normal working.

NOTE. If the Hand-Held Terminal is plugged into the instrument you cannot use these buttons. Instead, select Loop '3' to enter display mode (via the LN parameter in ??CMD mode), and either Loop 1 or 2 to exit.

Display Assignment. Display assignment differs slightly between the 6372 instruments, which have deviation bargraphs, and the 6382, which instead have dual bargraphs. This is shown in Figure 4.48.

In both series the *digital display* is driven by the DD parameter and the *horizontal output display* ('Bargraph 3') is driven by the 3B parameter. In the 6372 instruments, parameter 1B drives the *deviation bargraph* ('Bargraph 1'). In the 6382 instruments, both left and right *vertical bargraphs* are assignable, to the 1B and 2B parameters respectively ('Bargraph 1' and 'Bargraph 2').

Block Connections

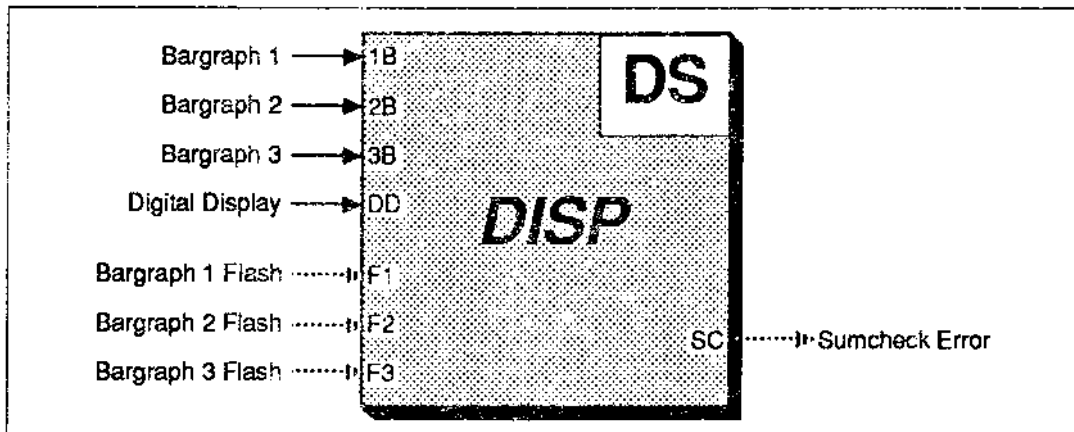

Figure 4.49 *DISP Block Connections*

Figure 4.49 represents the DISP block incoming and outgoing connections.

Incoming Connections. The connections coming into the DISP block are summarised in Table 4.48.

Code	Connection	Function	Format*
1B	Bargraph 1	Input to <i>dev. bargraph</i> (6372), or left-hand <i>vertical bargraph</i> (6382). Ranged by 1H, 1L	FP
2B	Bargraph 2	Input to right-hand <i>vertical bargraph</i> (6382 only). Ranged by 2H, 2L	FP
3B	Bargraph 3	Input to <i>horizontal output bargraph</i> (all models). Ranged by 3H, 3L	FP

DD	Digital Display	Unranged input to <i>digital display</i> (all models)	FP
F1	Bargraph 1 Flash	Logic 1 flashes Bargraph 1	0/1
F2	Bargraph 2 Flash	Logic 1 flashes Bargraph 2 (6382 only)	0/1
F3	Bargraph 3 Flash	Logic 1 flashes Bargraph 3	0/1

Table 4.48 *DISP Incoming Connections*

Outgoing Connections. Table 4.49 summarises the single outgoing connection from the DISP block.

Code	Connection	Function	Format*
SC	Sumcheck Error	Latches to 1 on sumcheck failure	0/1

Table 4.49 *DISP Outgoing Connections*

Block Parameters

Table 4.48 lists the DISP parameters and the units or format in which they are expressed.

Mnemonic	Parameter	Format*
ST	Block Status	HHHH
1H	Bargraph 1 High Range	±Eng.
1L	Bargraph 1 Low Range	±Eng.
1B	Bargraph 1 Variable	±Eng.
2H	Bargraph 2 High Range	±Eng.
2L	Bargraph 2 Low Range	±Eng.
2B	Bargraph 2 Variable	±Eng.
3H	Bargraph 3 High Range	±Eng.
3L	Bargraph 3 Low Range	±Eng.
3B	Bargraph 3 Variable	±Eng.
DD	Digital Display Variable	±Eng.
FC	Function Control Register	HHHH

Table 4.50 *DISP Block Parameters*

Each of these parameters is covered in more detail in the sections that follow.

*See Table 4.2 for an explanation of these formats

ST Block Status

Figure 4.50 shows the meanings of the hexadecimal digits in the ST parameter of the Display block. (The symbols used in the parameter diagram are explained in Figure 4.2.)

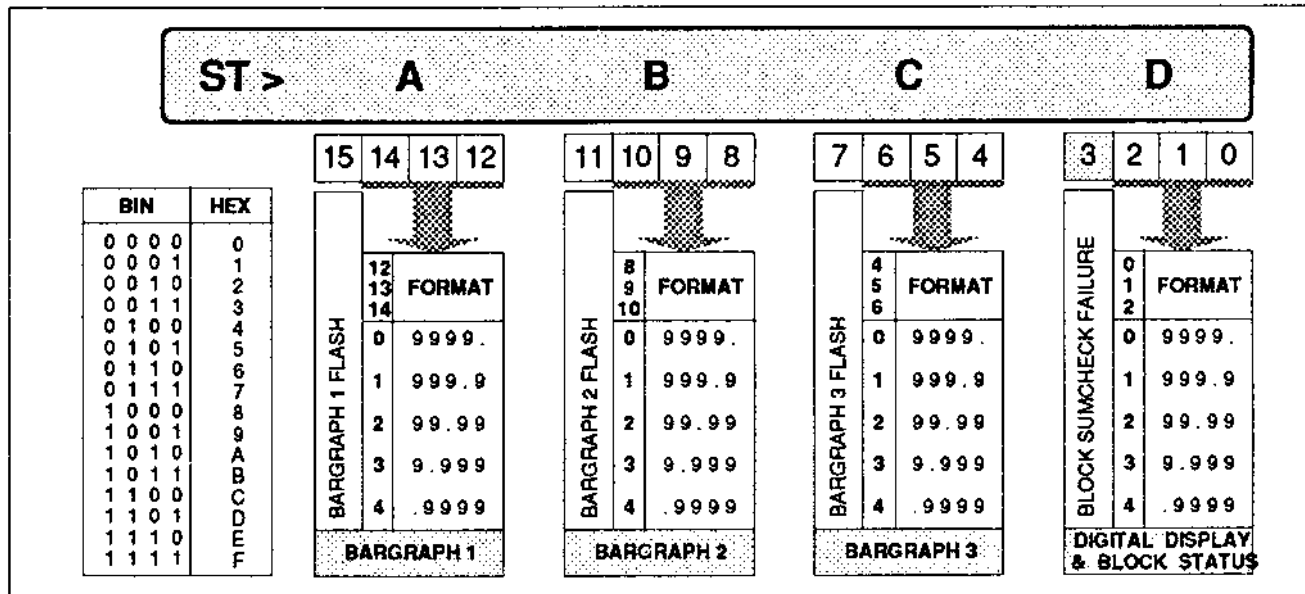

Figure 4.50 ST Parameter — Display Block

Decimal Point Selection — Digits A to D

The least significant three bits of digits A, B, C, and D select the decimal point positions for the 1B, 2B, 3B, and DD parameters respectively. The High and Low Ranging parameters corresponding to 1B, 2B, and 3B take corresponding decimal point positions.

Bargraph Flash Select — Digits A to C

The most significant bit of digits A, B, and C selects whether or not the corresponding bargraph (1, 2, or 3, respectively) flashes on and off. Logic 1 = flashing, logic 0 = steady.

1H & 1L Bargraph 1 High & Low Ranging

1H (High Range) and 1L (Low Range) define the span of the Bargraph 1 input, 1B. 1H may be greater or less than 1L, and either may be positive or negative. (If 1H is less than 1L, the display acts *inversely*). The two types of front panel range 1B differently:

Deviation Bargraph Instruments. Each unit of the $\pm 1B$ parameter displays as $\pm 100\% / (1H - 1L)$. Negative percentages display on the lower half of the deviation bargraph, and positive percentages on the upper half. The central LED is always the zero point, and $\pm 8\%$ is the maximum that can be displayed.

Dual Bargraph Instruments. $1H$ is the value of the $1B$ parameter giving a 100% bargraph display; $1L$ is the value of $1B$ giving a 0% display. Intermediate $1B$ values are displayed as a linear interpolation between the $1H-1L$ limits. The following are examples of dual bargraph displays.

Example 1 Parameters $1H = 99.99$, $1L = 00.00$.

The Bargraph 1 display will be as follows:

1B Input	Display %
99.99	100
50.00	50
00.00	0

Example 2 Parameters $1H = 99.99$, $1L = -99.99$.

The Bargraph 1 display will be as follows:

1B Input	Display %
99.99	100
00.00	50
-99.99	0

Example 3 Parameters $1H = -99.99$, $1L = 99.99$.

The Bargraph 1 display will be as follows:

1B Input	Display %
99.99	0
00.00	50
-99.99	100

NOTE. The percentage range that Bargraph 1 can display differs between the 6372 and 6382 instruments. Please refer to the next section, on parameter $1B$, for details.

1B Bargraph 1 Variable

The 1B parameter, ranged by 1H and 1L, drives the 'Bargraph 1' display. Its decimal point position is set by digit A of the ST parameter.

On 6372 front panels Bargraph 1 is the vertical 17-segment *deviation* bargraph, which can display only the first $\pm 8\%$ of 1B's range. On 6382 front panels Bargraph 1 is the left-hand vertical 101-segment bargraph, which can display the whole 1B range from 0% to 100%.

2H & 2L Bargraph 2 High & Low Ranging

2H (High Range) and 2L (Low Range) define the span of the Bargraph 2 input, 2B.

Please refer to the section on 1H & 1L (above) for details and examples of how ranging works; these correspond exactly to the 2H & 2L case.

2H, 2L, and 2B apply only to the 6382 instruments, which have dual bargraph displays.

2B Bargraph 2 Variable

The 2B parameter, ranged by 2H and 2L, drives the 'Bargraph 2' display. Its decimal point position is set by digit B of the ST parameter.

On 6382 front panels Bargraph 2 is the right-hand vertical 101-segment bargraph. 6372 instruments have no corresponding display, and the 2B parameter is redundant (though it appears on the Hand-Held Terminal).

3H & 3L Bargraph 3 High & Low Ranging

3H (High Range) and 3L (Low Range) define the span of the Bargraph 3 input, 3B.

Please refer to the section on 1H & 1L (above) for details and examples of how ranging works; these correspond exactly to the 3H & 3L case.

3B Bargraph 3 Variable

The 3B parameter, ranged by 3H and 3L, drives the 'Bargraph 3' display. Its decimal point position is set by digit C of the ST parameter.

On all Intelligent Loop Processor front panels Bargraph 3 is the horizontal 10-segment yellow *output bargraph*, below the digital display. Its ten segments can display the whole range of 3B from 0% to 100%, by lighting up from left to right as shown in Figure 4.51.

3B %	Bargraph 3 Display	
00.00 to 4.99		None Lit
5.00 to 14.99		
15.00 to 24.99		
25.00 to 34.99		
35.00 to 44.99		
45.00 to 54.99		
55.00 to 64.99		
65.00 to 74.99		
75.00 to 84.99		
85.00 to 94.99		
95.00 to 99.99		All Lit

Figure 4.51 *Bargraph 3 Display Ranges*

DD Digital Display Variable

The DD parameter drives directly (via a filter with 1 sec time constant) the front panel *digital* display; no ranging is applied. It can have any value from -9999 to +9999, with the decimal point position set by digit D of the ST parameter.

FC Function Control Register

The FC parameter is explained on page 4.19. Please refer there for details.

ALRM : ALARM BLOCK

Block Function

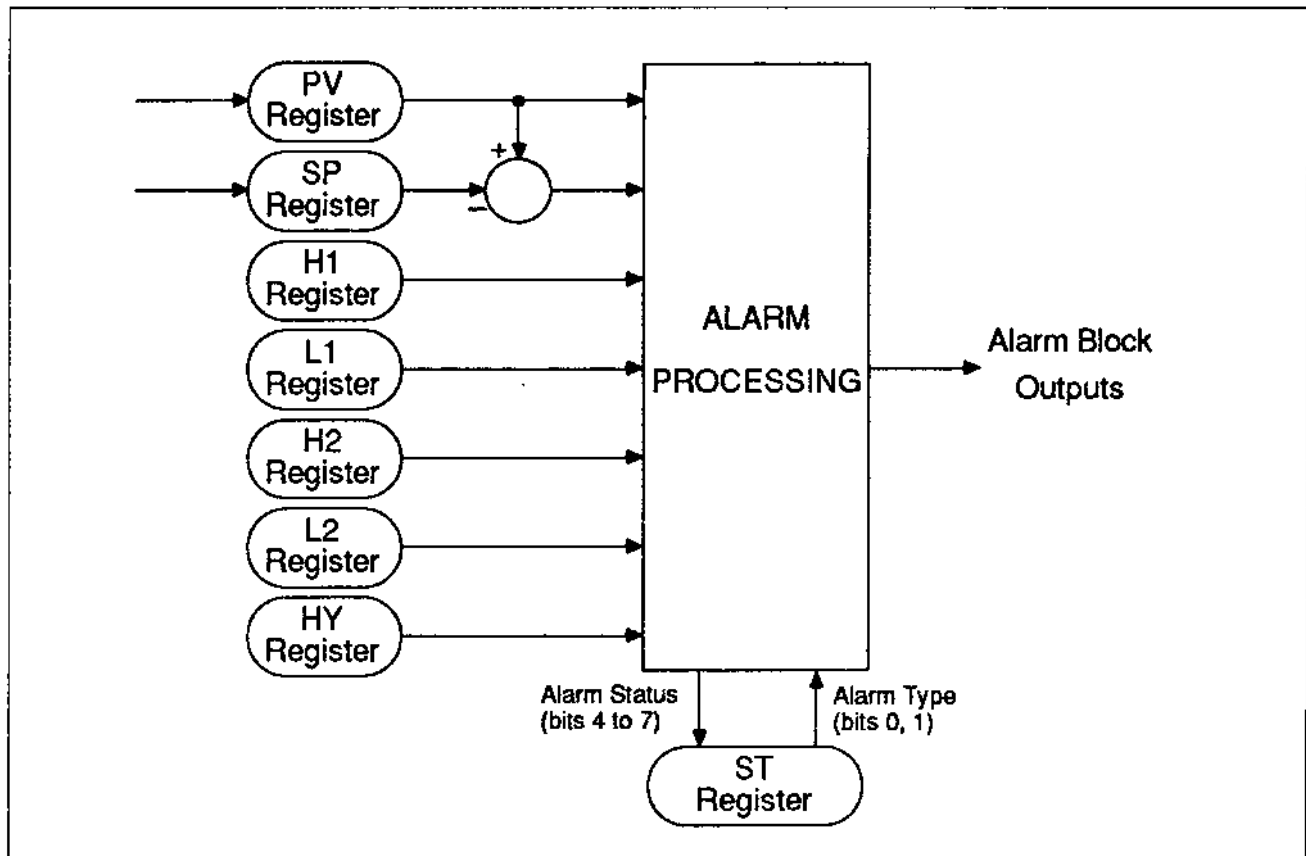

Figure 4.52 Alarm Block Schematic

Please refer to Figure 4.52. The ALRM block detects if an analogue input PV exceeds pre-defined limits, and sets digital outputs (and ST parameter bits 4 to 7) accordingly.

Absolute, Deviation, or Rate alarms can be detected, as determined by mode bits 0 and 1 in the block's ST parameter. Two independent levels of both high and low alarm are available (H1, L1 and H2, L2). An alarm setpoint input SP is provided for Deviation alarm calculation ($PV-SP$), and an alarm hysteresis value can be set via the HY parameter.

Block Connections

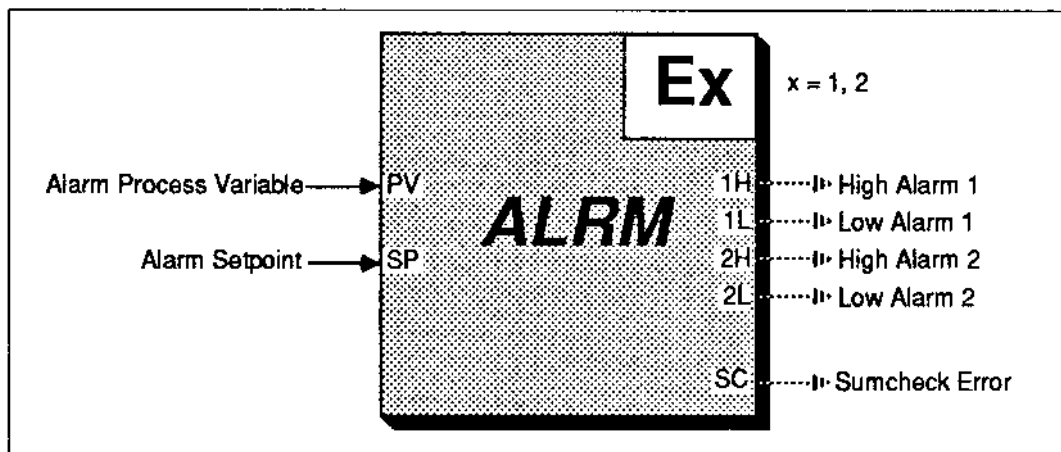

Figure 4.53 *ALRM Block Connections*

Figure 4.53 represents the ALRM block incoming and outgoing connections.

Incoming Connections. The connections coming into the ALRM block are summarised in Table 4.51.

Code	Connection	Function	Format*
PV	Alarm Process Variable		FP
SP	Alarm Setpoint		FP

Table 4.51 *ALRM Incoming Connections*

Outgoing Connections. The connections coming out of the block are detailed in Table 4.52.

Code	Connection	Function	Format*
1H	High Alarm 1	Outputs logic 1 when test value > H1	0/1
1L	Low Alarm 1	Outputs logic 1 when test value outside† L1	0/1
2H	High Alarm 2	Outputs logic 1 when test value > H2	0/1
2L	Low Alarm 2	Outputs logic 1 when test value outside† L2	0/1
SC	Sumcheck Error	Latches to 1 on sumcheck failure	0/1

Table 4.52 *ALRM Outgoing Connections*

*See Table 4.2 for an explanation of these formats

†See under H1 & L1 for threshold definitions

Block Parameters

Table 4.53 lists the ALRM block parameters and the units or format in which they are expressed.

Mnemonic	Parameter	Format*
ST	Block Status	HHHH
H1	High Alarm Level 1	±Eng.
L1	Low Alarm Level 1	±Eng.
H2	High Alarm Level 2	±Eng.
L2	Low Alarm Level 2	±Eng.
PV	Alarm Process Variable	±Eng.
SP	Alarm Setpoint	±Eng.
HY	Alarm Hysteresis	Eng.
FC	Function Control Register	HHHH

Table 4.53 ALRM Block Parameters

These parameters are covered in more detail in the sections that follow.

ST Block Status

Figure 4.54 shows the meanings of the hexadecimal digits in the ST parameter of the Alarm block. (The symbols used in the parameter diagram are explained in Figure 4.2.)

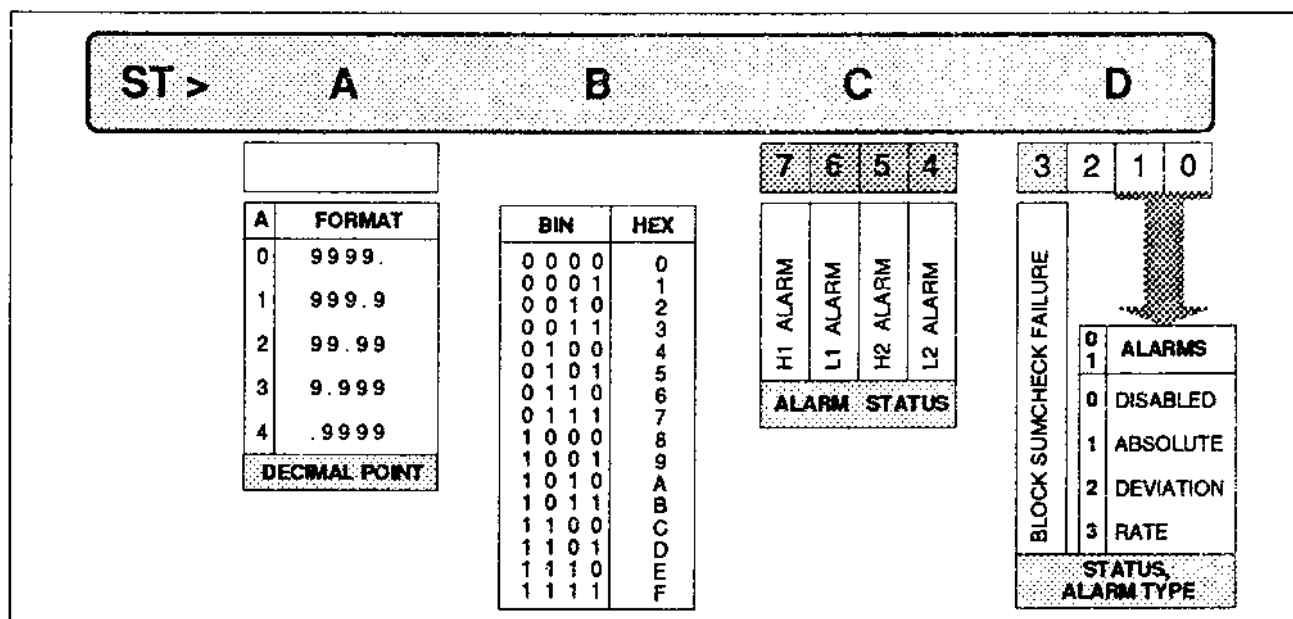

Figure 4.54 ST Parameter — Alarm Block

*See Table 4.2 for an explanation of these formats

Decimal Point Selection — Digit A

Digit A selects the decimal point position for all the Alarm block parameters expressed in engineering units.

Alarm Status — Digit C

Each of the read-only bits of digit C sets to logic 1 whenever the corresponding alarm is being generated. The bits reset to zero only when the alarm variable has returned inside the defined level by a margin equal to the *hysteresis* value (parameter HY).

Block Status & Alarm Type — Digit D

- **Sumcheck Failure — Bit 3.** Bit 3 of digit D automatically latches to logic 1 whenever the CPU detects a sumcheck failure in any of the parameters of the ALRM block. To clear this condition, re-enter any corrupted parameters, and then write a zero to bit 3.
- **Alarm Type — Bits 1 & 0.** Read/write bits 1 and 0 define the *type* of alarm the block is operating, according to this table:

Bit 1	Bit 0	Hex	Alarm Type Selected
0	0	0	<i>Alarms disabled</i>
0	1	1	Absolute alarms
1	0	2	Deviation alarms
1	1	3	Rate (velocity) alarms

The three types of alarm are explained in the section on parameters H1 & L1, below.

H1 & L1 First High & Low Alarm Levels

These are multi-purpose alarm level parameters with functions determined by which of the three alarm types has been selected (by bits 1 and 0 of the ST parameter).

When alarm conditions are being cleared, these levels are modified by the application of *hysteresis*. See the section on the HY parameter below.

When alarms are generated the appropriate bits of digit C in the ST parameter set to logic 1. You can disable all alarms by setting ST bits 1 and 0 to logic zero.

Absolute Alarms. H1 and L1 set the limits, in engineering units, outside which PV will generate high or low alarms, respectively. H1 may be greater or less than L1, and either may be positive or negative.

Deviation Alarms. H1 sets the limit above which the positive deviation ($PV - SP$) will generate a high alarm, and L1 sets the limit above which the negative deviation ($SP - PV$) will generate a low alarm. H1 and L1 both have positive values in engineering units. (Negative values can be entered but are treated as positive in the block's calculations.)

Rate Alarms. H1 sets the limit above which PV's rate of increase will generate a high alarm, and L1 sets the limit above which PV's rate of decrease will generate a low alarm. H1 and L1 both have positive values in engineering units. (Negative values can be entered but are treated as positive in the block's calculations.)

H2 & L2 Second High & Low Alarm Levels

H2 and L2 are a second independent pair of alarm levels, useful when your control strategy needs two-stage alarms. Their functions correspond exactly to those of H1 and L1, described above.

PV Alarm Process Variable

PV defines, in engineering units, the value of the process variable signal used by the Alarm block for alarm monitoring and generation. The block can be set to generate *absolute* alarms (from PV), *deviation* alarms (from $|PV - SP|$), or *rate* alarms (from dPV/dt).

SP Alarm Setpoint

SP defines, in engineering units, the value of the setpoint signal used by the Alarm block for deviation alarm monitoring and generation. Positive deviation is calculated as $PV - SP$, and negative deviation as $SP - PV$. When these deviations exceed the high or low alarm limits (H1, H2, and L1, L2), respectively, corresponding alarms are generated.

HY Alarm Hysteresis

HY defines, in positive engineering units, the value of the hysteresis used by the Alarm block when clearing alarms. Alarm conditions are *triggered* as soon as levels are exceeded but are *cleared* only when the alarm variable value has returned inside the defined limit by a margin equal to HY.

FC Function Control Register

The FC parameter is explained on page 4.19. Please refer there for details.

CHAR : CHARACTERISER BLOCK

Block Function

The CHAR block conditions an analogue input by applying a user-programmed 16-breakpoint characterisation function, with linear interpolation between data points.

Block Connections

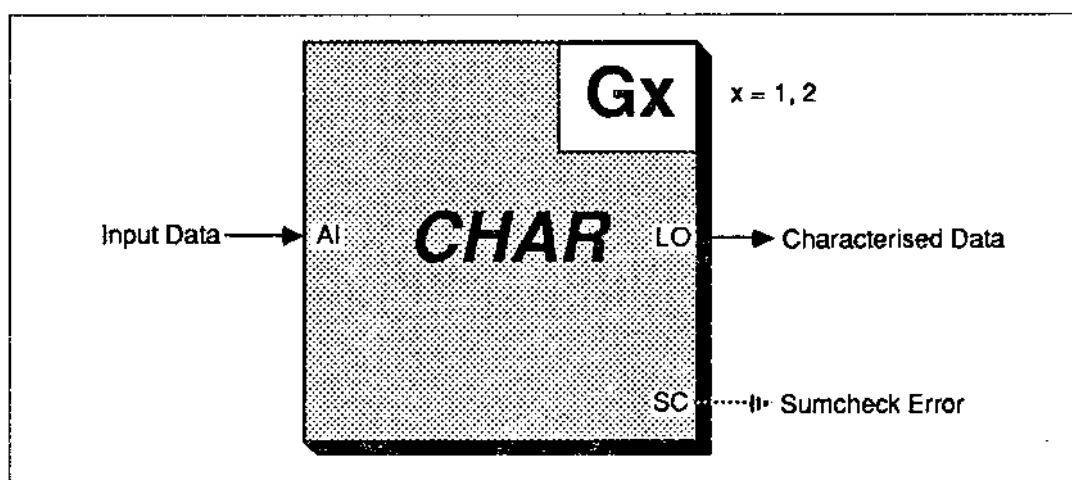

Figure 4.55 CHAR Block Connections

Figure 4.55 represents the CHAR block incoming and outgoing connections.

Incoming Connections. The connections coming into the CHAR block are summarised in Table 4.54.

Code	Connection	Function	Format*
AI	Input Data	Signal to be characterised	FP

Table 4.54 CHAR Incoming Connections

Outgoing Connections. The connections coming out of the block are detailed in Table 4.55.

Code	Connection	Function	Format*
LO	Block Output	Characterised Data	FP
SC	Sumcheck Error	Latches to 1 on sumcheck failure	0/1

Table 4.55 CHAR Outgoing Connections

Block Parameters

Table 4.56 lists the CHAR block parameters and the units or format in which they are expressed.

Mnemonic	Parameter	Format*
ST	Block Status	HHHH
AI	Input Data	±Eng.
0X to FX	16 x-axis (input) co-ordinates	±Eng.
0Y to FY	16 y-axis (output) co-ordinates	±Eng.
FC	Function Control Register	HHHH

Table 4.56 CHAR Block Parameters

These parameters are covered in more detail in the sections that follow.

ST Block Status

Figure 4.56 shows the meanings of the hexadecimal digits in the ST parameter of the Characteriser block. (The symbols used in the parameter diagram are explained in Figure 4.2.)

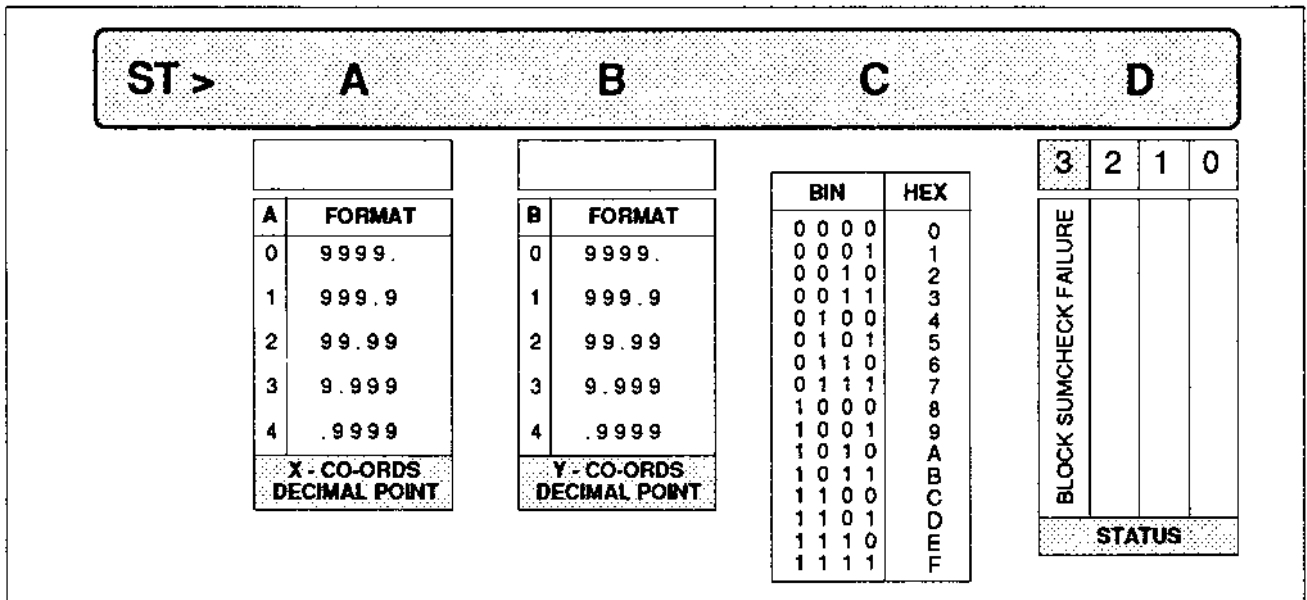

Figure 4.56 ST Parameter — Characteriser Block

Decimal Point Selection — Digits A & B

Digit A selects the decimal point position for the AI input parameter and all the x-axis co-ordinate parameters (0X to FX). Digit B selects the decimal point position for the LO output and all the y-axis co-ordinate parameters (0Y to FY).

*See Table 4.2 for an explanation of these formats

Block Status — Digit D

Bit 3 of digit D automatically latches to logic 1 whenever the CPU detects a sumcheck failure in any of the parameters of the CHAR block. To clear this condition, re-enter any corrupted parameters, and then write a zero to bit 3.

AI Input Data

AI defines, in engineering units, the value of the analogue input signal to be characterised by the block. Its decimal point is set by digit A of the ST parameter.

0X to FX X-Axis Co-ordinates

These parameters define the 16 *x*-axis co-ordinates of the characteristic, being half of the complete set of points: (0X, 0Y), (1X, 1Y), ... (FX, FY). They are used by the *input* signal AI, and can be positive or negative but must monotonically increase from 0X to FX. That is, 1X must exceed 0X, 2X must exceed 1X, 3X must exceed 2X, and so on.

If the block input AI falls *between* two *x*-axis co-ordinates, a linear interpolation is done between the two corresponding points to calculate the output value LO. If AI lies *outside* the range 0X to FX, the output LO is simply set to the corresponding extreme *y*-axis co-ordinate (0Y or FY).

NOTE. If you need only the first 'n' breakpoints to define the characteristic you must nevertheless write a dummy value to each of the remaining (nX to FX) parameters. Use the last, i.e. highest, *x*-axis value for this. The unused *y*-axis co-ordinates are ignored and so have 'don't care' values.

0Y to FY Y-Axis Co-ordinates

These parameters define the 16 *y*-axis co-ordinates of the characteristic, being half of the complete set: (0X, 0Y), (1X, 1Y), ... (FX, FY). Unlike the *x*-axis parameters, they can take any engineering unit values and need not be unique.

FC Function Control Register

The FC parameter is explained on page 4.19. Please refer there for details.

Chapter 5

ASSIGNED FUNCTION BLOCKS

The instrument provides you with a number of *function blocks* that let you define the interface between analogue and digital signals, setpoints, control, and the displays.

Function blocks take in analogue or digital signals via their inputs, process them in a variety of ways, and then pass the results on via their outputs. You connect the configured function blocks together so that the signals can flow between them (and the field) to execute your control strategy.

There are two types of function block in this instrument:

- Assigned blocks, which are dealt with in this chapter
- Fixed blocks, covered in the previous chapter.

Assigned blocks carry out the *mathematical, logical, and communications* operations needed in a control strategy. If you have one of the 6372/82 instruments, you can deploy up to 80 assigned blocks in your strategy, chosen from a resident library of around 40 block types. For the 6370/80 instruments, it is 12 assigned blocks chosen from a sub-set library of 12 block types.

Unlike fixed blocks, assigned blocks can be installed at any of the two-digit addresses in the instrument's memory reserved for them. You can use a given assigned block any number of times in your strategy, limited only by how many addresses are available.

Table 5.1 lists the assigned blocks (available at time of issue of this manual) in the Intelligent Loop Processor series of instruments. The blocks above the dashed line are the sub-set of 12 available in the 6370/80 instruments.

Block	Function
ADD2	Adds two analogue inputs
SUBT	Subtracts two analogue inputs
MPLY	Multiplies two analogue inputs
DIVD	Divides one analogue input by another
EXPN	Raise to Power ($1A^{2A}$)
AND4	ANDs four digital inputs
OR4	ORs four digital inputs
LTCH	Set/Reset Latch
HSL2	Higher of two analogue inputs
LSL2	Lower of two analogue inputs
EU	Equal to
PGNT	Rectangular-wave pulse generator
MSL3	Median of three analogue inputs
SIN	Sine (input in radians)
COS	Cosine (input in radians)
TAN	Tangent (input in radians)
ROOT	Square root
EXP	Exponential Function (e^{1A})
ABS	Absolute value (modulus)
NEGT	Negation
NLOG	Natural logarithm
INT	Converts floating point analogue input to integer
RANG	Re-ranges an analogue input
PEAK	Detects maxima or minima in an analogue input
SAMP	Sample-and-hold 4 Constants
CONS	Stores four constants (engineering units)
AND2	ANDs two digital inputs
OR2	ORs two digital inputs
XOR2	XORs two digital inputs
NOT	Logical NOT
GT	Greater than
LT	Less than
SLCT	Selects between one of two analogue inputs
AVG2	Average of two analogue inputs
RATE	Limits rate of change of an analogue input
RAMP	Ramps an analogue output up or down
PCNT	Counts rising edges of a digital input
TIME	Incremental timer
AICB	Single-channel Pseudo Analogue Input (Comms.)
AOCB	Single-channel Pseudo Analogue Output (Comms.)
DICB	Eight-channel Pseudo Digital Input (Comms.)
DOCB	Eight-channel Pseudo Digital Output (Comms.)

Table 5.1 Assigned Blocks Library

Key to Block Connection Diagrams

Figure 5.1 shows the meanings of the symbols used in the block connection diagrams throughout this chapter.

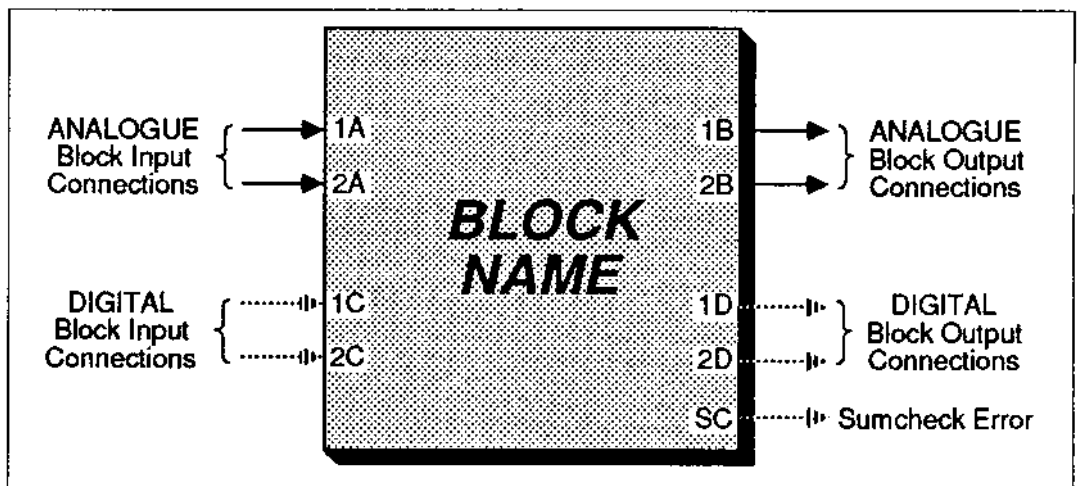

Figure 5.1 Key to Block Connection Diagrams

Each diagram shows the block name (but not the address, which is variable), together with any inputs and outputs.

NOTE. The names of assigned block connections have the connection *number* coming first (e.g. 1A, 2A) to avoid confusion with fixed block addresses, where the *letter* comes first (e.g. A1, A2).

In the sections that follow, an input/output label represents not only the *name* of the connection you use when configuring the instrument. It also represents the *value* of the signal at that point, in the algebraic formula defining the block's action.

Block Names. All block names in this series of instruments consist of four alphanumeric characters. Blocks with apparently fewer characters in their names (e.g. SIN, COS, LT) actually have following *space* characters to make up the total. These spaces must be keyed into the Hand-Held Terminal when entering the name, otherwise it won't be accepted by the instrument.

Default Values

In assigned blocks, unconnected *digital* inputs not accessing parameters default to logic 0, whereas similar unconnected *analogue* inputs default to a value of 1. This means that you can use some blocks to generate *constants*, with values set by the relevant scaling constants. For example, an ADD2 block with unconnected (analogue) inputs and both scaling constants set to 3 will output the constant value of 6.

Ranges of Analogue Inputs & Outputs

Block input and output analogue values (1A, 2A, ..., 1B, 2B, ...) can be anywhere in the range $\pm 10^{38}$, processed in 16-bit floating point format. Results outside these limits are reduced to $\pm 10^{38}$, and no error warning is given. Output ranges may of course be further limited by the block type (e.g. trigonometric functions).

These limits apply only to the actual numbers being used in the block computations and passing between blocks; the size of number that can be displayed on the front panel digital display of the instrument and held in parameters is limited to ± 9999 . Numbers outside these limits are displayed as ± 9999 , and no error warning is indicated.

Constants and scaling constants (1K, 2K, ...) are limited to the range ± 9999 . If you try to store a constant outside this range it will be limited to ± 9999 , without warning. This could happen, for example, if you are updating a constant in a SAMP block with the output from a Maths block.

ASSIGNED BLOCKS

MATHS BLOCKS: ARITHMETIC

ADD2: ADD
SUBT: SUBTRACT
MPLY: MULTIPLY
DIVD: DIVIDE
AVG2: AVERAGE

Block Connections

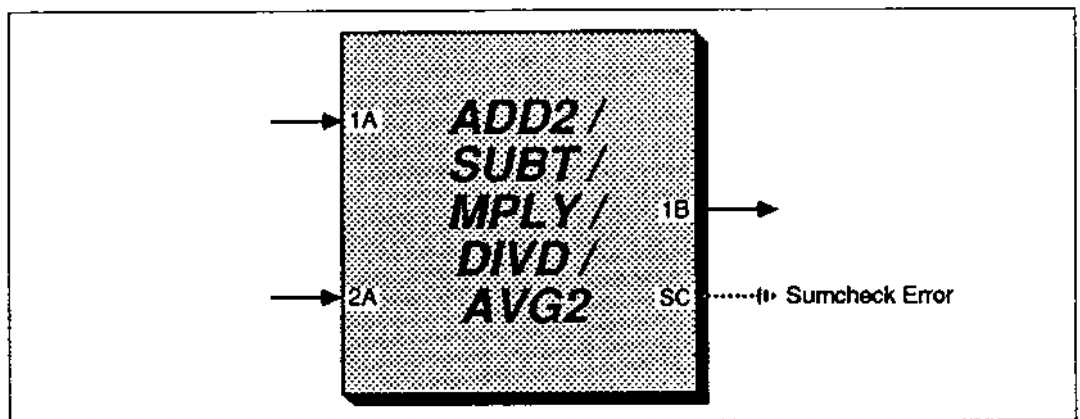

Figure 5.2 Connections for Arithmetic Blocks

The five arithmetic blocks carry out basic maths functions. They have two analogue inputs and one analogue output (see Figure 5.2), and two scaling constants, parameters 1K and 2K, which scale inputs 1A and 2A respectively (unless bit 15 of the ST parameter has been set). ST fixes the 1K and 2K decimal point positions. The SC digital output is normally at logic 0, setting to 1 on sumcheck failure.

Block Functions

ADD2 Block.	$1B = (1K \times 1A) + (2K \times 2A)$
SUBT Block.	$1B = (1K \times 1A) - (2K \times 2A)$
MPLY Block.	$1B = (1K \times 1A) \times (2K \times 2A)$
DIVD Block.	$1B = (1K \times 1A) / (2K \times 2A)$
AVG2 Block.	$1B = [(1K \times 1A) + (2K \times 2A)] / 2$

Block Parameters

Table 5.2 lists the Arithmetic blocks parameters and the units or format in which they are expressed.

Mnemonic	Parameter	Format*
ST	Block Status	HHHH
1K	Scaling Constant for 1A	±Eng.
2K	Scaling Constant for 2A	±Eng.
FC	Function Control Register	HHHH

Table 5.2 Arithmetic Blocks Parameters

Each of these parameters is covered in more detail in the sections that follow.

ST Block Status

Figure 5.3 shows the meanings of each of the hexadecimal digits in the ST parameter of the five Arithmetic blocks. (The symbols used in the parameter diagram are explained in Figure 4.2.)

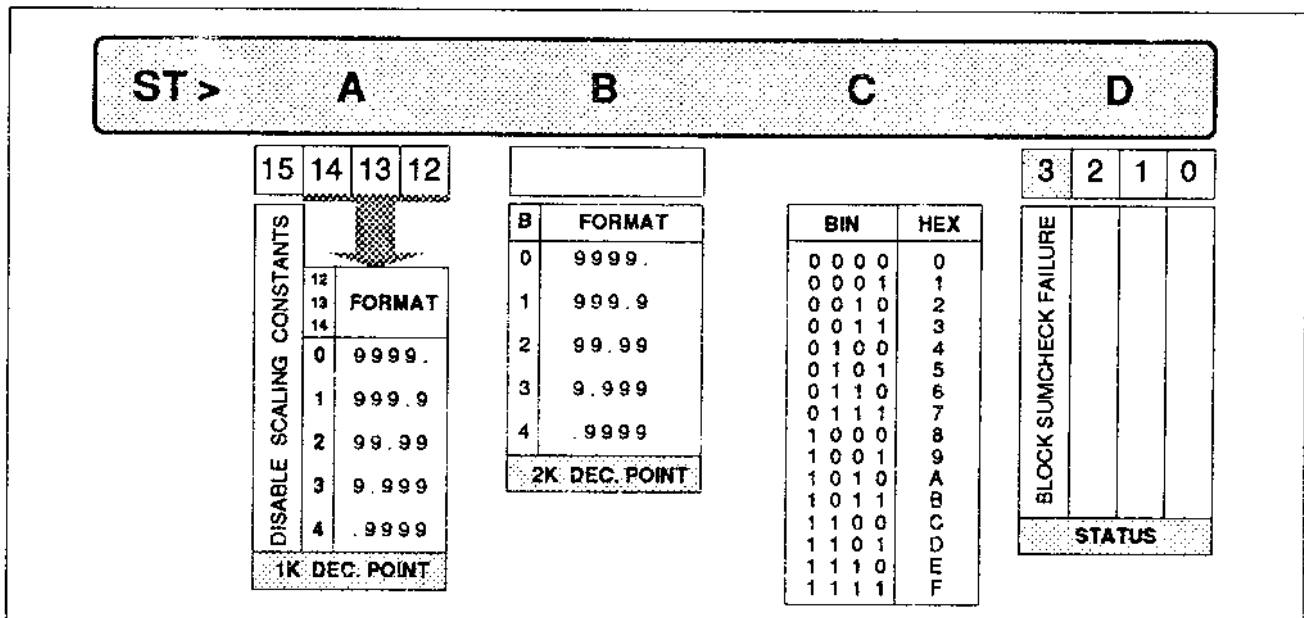

Figure 5.3 ST Parameter — Arithmetic Blocks

Bit 3 of digit D automatically latches to logic 1 whenever the CPU detects a sumcheck error in any of the particular Arithmetic block's parameters. Also, the block's sumcheck error digital output SC, normally at logic 0, sets to logic 1 when this happens.

*See Table 4.2 for an explanation of these formats

To clear this condition, re-enter any corrupted parameters, and then reset bit 3 to logic 0. The SC output follows bit 3 and also resets to logic 0.

1K & 2K Scaling Constants

1K and 2K are the multipliers of 1A and 2A respectively, in all five Arithmetic blocks. Their decimal point positions are set by digits A and B, respectively, of the ST parameter.

To disable 1K and 2K, set bit 15 of the ST parameter to logic 1. This actually prevents 1A and 2A from being multiplied by the scaling constants, and so shortens the execution time of the block.

FC Function Control Register

The FC parameter is explained in Chapter 4, *Fixed Function Blocks*, on page 4.19. Please refer there for details.

MATHS BLOCKS: TRIGONOMETRIC

SIN : SINE

COS : COSINE

TAN : TANGENT

Block Connections

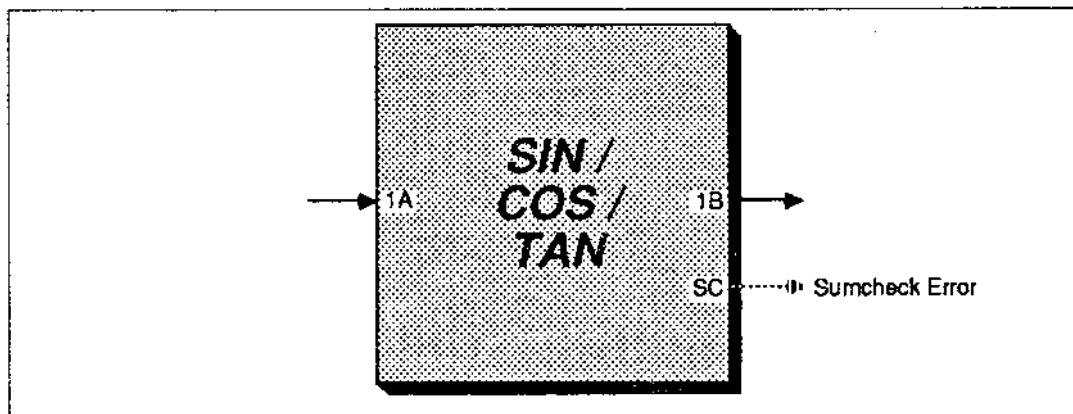

Figure 5.4 Connections for Trigonometric Blocks

The three trigonometric blocks carry out basic trig functions, on inputs measured in *radians*. All the blocks have one analogue input and one analogue output, as shown in Figure 5.4. There are no scaling constants. The SC digital output is normally at logic 0 and sets to 1 on sumcheck failure.

NOTE. The three letters in each block name are actually followed by a *space* to make them up to the standard four characters. You must key this space into the Hand-Held Terminal when entering a three-letter block name, otherwise it won't be accepted.

Block Functions

SIN Block. $1B = \text{Sine } 1A \text{ (rads)}$

COS Block. $1B = \text{Cosine } 1A \text{ (rads)}$

TAN Block. $1B = \text{Tangent } 1A \text{ (rads)}$

Block Parameters

Table 5.3 lists the trigonometric block parameters and the units or format in which they are expressed.

Mnemonic	Parameter	Format*
ST	Block Status	HHHH
FC	Function Control Register	HHHH

Table 5.3 Trigonometric Blocks Parameters

Each of these parameters is covered in more detail in the sections that follow.

ST Block Status

Figure 5.5 shows the meanings of each of the hexadecimal digits in the ST parameter of the three Trigonometric blocks. (The symbols used in the parameter diagram are explained in Figure 4.2.)

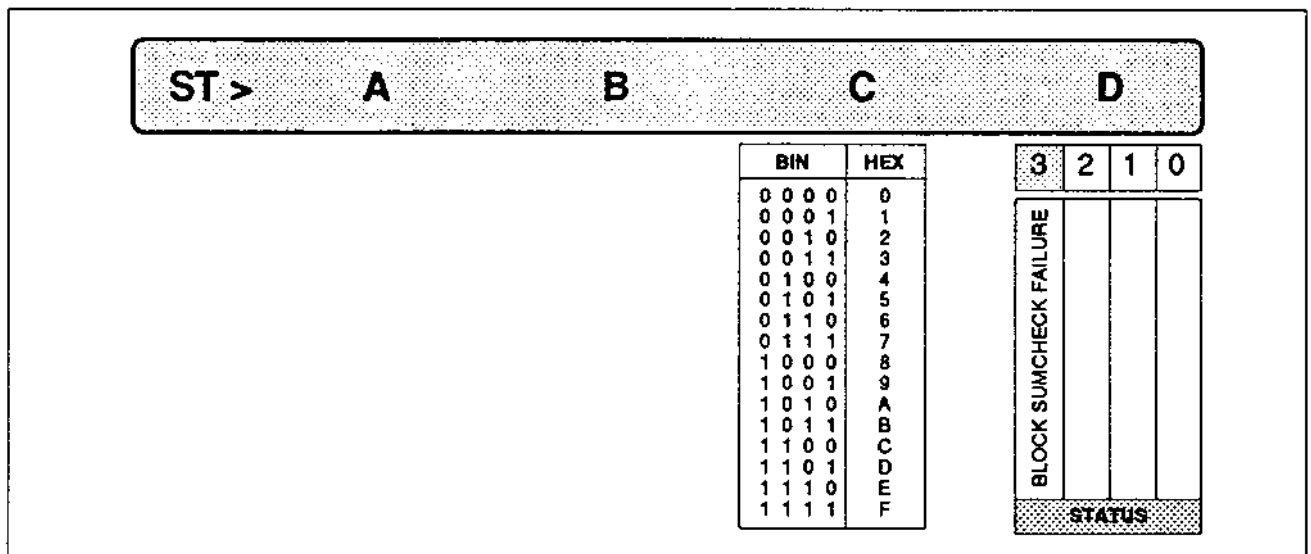

Figure 5.5 ST Parameter — Trigonometric Blocks

Bit 3 of digit D automatically latches to logic 1 whenever the CPU detects a sumcheck error in any of the particular Trigonometric block's parameters. Also, the block's sumcheck error digital output SC, normally at logic 0, sets to logic 1 when this happens.

To clear this condition, re-enter any corrupted parameters, and then reset bit 3 to logic 0. The SC output follows bit 3 and also resets to logic 0.

*See Table 4.2 for an explanation of these formats

FC Function Control Register

The FC parameter is explained on page 4.19. Please refer there for details.

ASSIGNED BLOCKS

MATHS BLOCKS: OPERATORS

ROOT : SQUARE ROOT

EXP : EXPONENTIAL

ABS : ABSOLUTE VALUE

NEGT : NEGATION

NLOG : NATURAL LOGARITHM

Block Connections

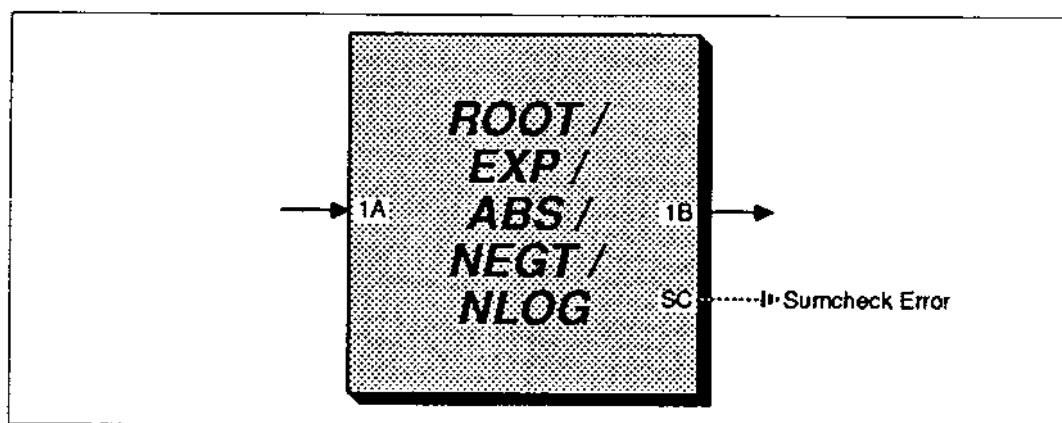

Figure 5.6 Connections for Operator Blocks

All operator blocks have one analogue input and one analogue output, as shown in Figure 5.6. There are no scaling constants. The SC digital output is normally at logic 0 and sets to 1 on sumcheck failure.

NOTE. The block names with three letters are actually followed by a *space* to make them up to the standard four characters. You must key this space into the Hand-Held Terminal when entering a three-letter block name, otherwise it won't be accepted.

Block Functions

ROOT Block.	$1B = \sqrt{1A}$
EXP Block.	$1B = e^{1A}$
ABS Block.	$1B = 1A $
NEGT Block.	$1B = -1A$
NLOG Block.	$1B = \log_e 1A$

NOTE. In the ROOT block, the square roots of negative inputs are computed as *zero*.

Block Parameters

Table 5.4 lists the Operator block parameters and the units or format in which they are expressed.

Mnemonic	Parameter	Format*
ST	Block Status	HHHH
FC	Function Control Register	HHHH

Table 5.4 *Operator Blocks Parameters*

The Operator block parameters ST and FC correspond exactly to the parameters of the Trigonometric blocks, which are described on page 5.9 above. Please refer there for details.

MATHS BLOCKS: OPERATORS (TWO INPUTS)

EXPN : EXPONENT

Block Connections

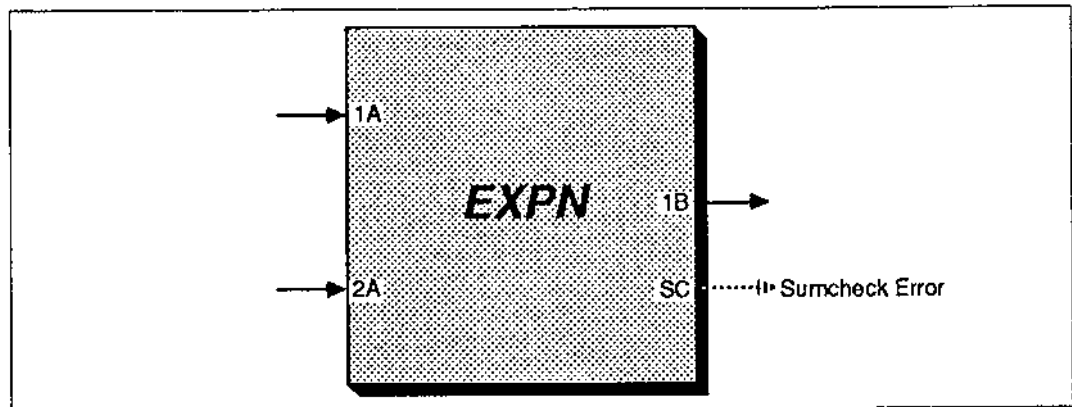

Figure 5.7 Exponent Block Connections

The EXPN block (Figure 5.7) is used to raise one input value to the power of the other input value. There are no scaling constants. The SC digital output is normally at logic 0 and sets to 1 on sumcheck failure.

Block Function

EXPN Block. $1B = 2A^{1A}$

Block Parameters

Table 5.5 lists the EXPN block parameters and the units or format in which they are expressed.

Mnemonic	Parameter	Format*
ST	Block Status	HHHH
FC	Function Control Register	HHHH

Table 5.5 EXPN Block Parameters

The EXPN block parameters ST and FC correspond exactly to the parameters of the Trigonometric blocks, which are described on page 5.9 above. Please refer there for details.

*See Table 4.2 for an explanation of these formats

MATHS BLOCKS: OPERATORS

INT : INTEGER

Block Function

The INT block converts floating point data to 'integer' format, by truncating the decimal part of the input. Rounding up is not performed; e.g. 5.99 is converted to 5. The resulting integer is output in floating point format.

Block Connections

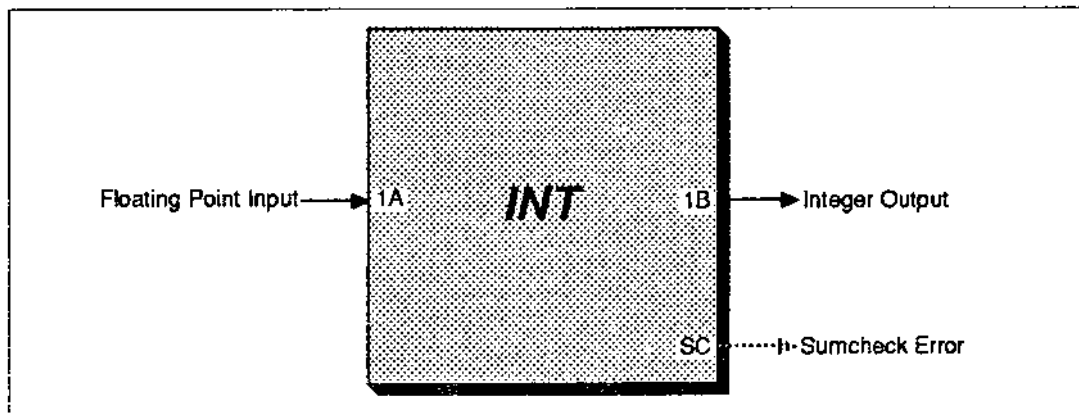

Figure 5.8 INT Block Connections

Figure 5.8 represents the INT block incoming and outgoing connections.

Incoming Connections. The connections coming into the INT block are summarised in Table 5.6.

Code	Connection	Function	Format*
1A	Input Data	Floating-point input	FP

Table 5.6 INT Incoming Connections

Outgoing Connections. Table 5.7 summarises the outgoing connections from the INT block.

Code	Connection	Function	Format*
1B	Output data	Integer (truncated) output	FP
SC	Sumcheck Error	Latches to 1 on sumcheck failure	0/1

Table 5.7 INT Outgoing Connections

Block Parameters

Table 5.8 lists the INT block parameters and the units or format in which they are expressed.

Mnemonic	Parameter	Format*
ST	Block Status	HHHH
FC	Function Control Register	HHHH

Table 5.8 *INT Block Parameters*

The INT block parameters ST and FC correspond exactly to the parameters of the Trigonometric blocks, which are described on page 5.9 above. Please refer there for details.

*See Table 4.2 for an explanation of these formats

MATHS BLOCKS: OPERATORS

RANG : RANGE & LIMIT

Block Function

The RANG block re-ranges an analogue input.

Block Connections

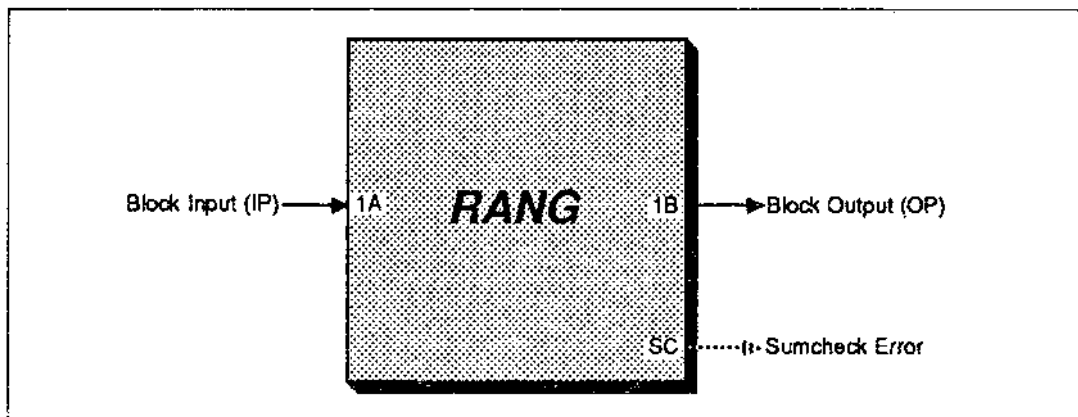

Figure 5.9 RANG Block Connections

Figure 5.9 represents the RANG block incoming and outgoing connections. The two-letter mnemonics in brackets are the parameters accessed by the connections.

Incoming Connections. The connections coming into the RANG block are summarised in Table 5.9.

Code	Connection	Function	Format*
1A	Input Data	Input to be re-ranged	FP

Table 5.9 RANG Incoming Connections

Outgoing Connections. Table 5.10 summarises the outgoing connections from the RANG block.

Code	Connection	Function	Format*
1B	Output data	Re-ranged output	FP
SC	Sumcheck Error	Latches to 1 on sumcheck failure	0/i

Table 5.10 RANG Outgoing Connections

Block Parameters

Table 5.11 lists the RANG block parameters and the units or format in which they are expressed.

Mnemonic	Parameter	Format*
ST	Block Status	HHHH
IH	Input High Range	±Eng.
IL	Input Low Range	±Eng.
OH	Output High Range	±Eng.
OL	Output Low Range	±Eng.
IP	Input Value	±Eng.
OP	Output Value	±Eng.
FC	Function Control Register	HHHH

Table 5.11 RANG Block Parameters

These parameters are covered in more detail in the sections that follow.

ST Block Status

Figure 5.10 shows the meanings of the hexadecimal digits in the ST parameter of the Range & Limit block. (The symbols used in the parameter diagram are explained in Figure 4.2.)

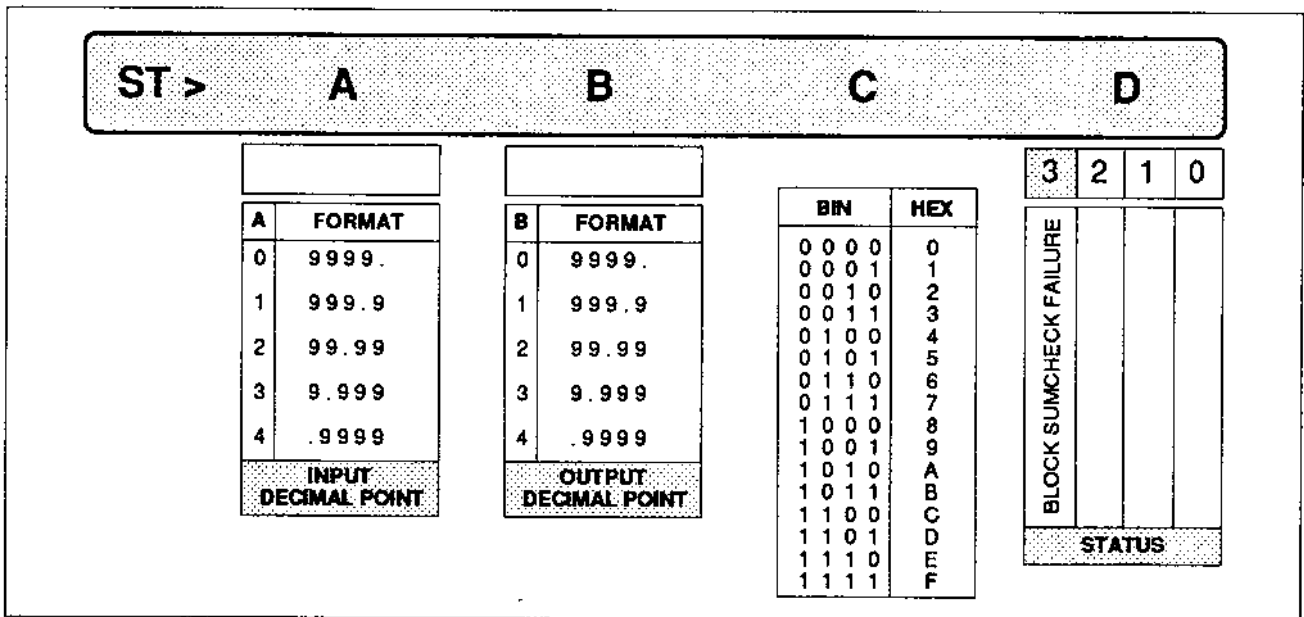

Figure 5.10 ST Parameter — Range & Limit Block

*See Table 4.2 for an explanation of these formats

Decimal Point Selection — Digits A & B

A and B select the decimal point positions for the *input* (IH, IL, IP) and the *output* (OH, OL, OP) parameters, respectively.

Block Status — Digit D

Bit 3 of digit D automatically latches to logic 1 whenever the CPU detects a sumcheck failure in any of the parameters of the RANG block. To clear this condition, re-enter any corrupted parameters, and then write a zero to bit 3.

IH & IL Input High & Low Ranges

IH (High Range) and IL (Low Range) define in engineering units the span of the block's analogue input value IP. IH may be greater or less than IL, and either may be positive or negative.

OH & OL Output High & Low Ranges

OH (High Range) and OL (Low Range) define in engineering units the span of the block's analogue output value OP. OH may be greater or less than OL, and either may be positive or negative.

IP Input Value

IP is the block's analogue input value, which is re-ranged by IH, IL, OH and OL. Its decimal point position is set by digit A of the ST parameter.

OP Output Value

OP is the block's analogue output value, which is the re-ranged version of IP. Its decimal point position is set by digit B of the ST parameter.

FC Function Control Register

The FC parameter is explained on page 4.19. Please refer there for details.

CONSTANTS BLOCKS

CONS: CONSTANTS

Block Connections

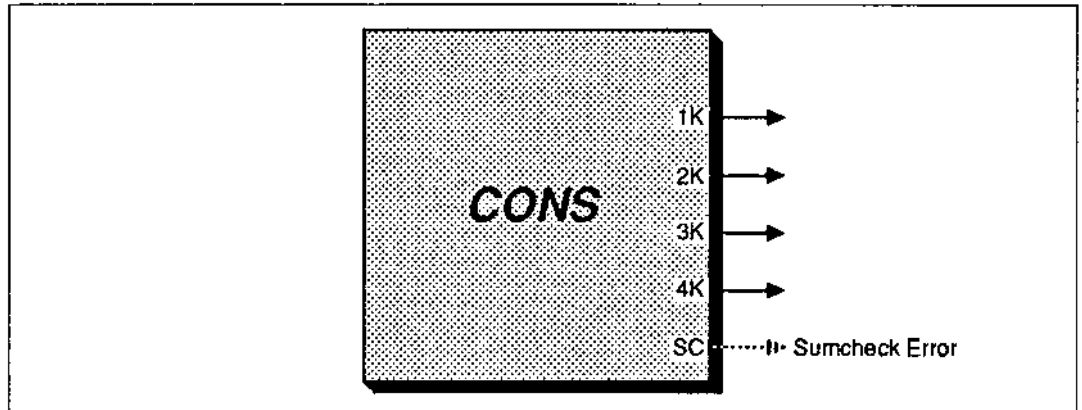

Figure 5.11 CONS Block Connections

The CONS block (Figure 5.11) lets you store four constants (per block) in the instrument, which you can use in your control strategy. Their decimal point positions are set by the ST parameter. The constants can be read/updated via the Hand-Held Terminal or RS422 data link, but not from within the control strategy itself. For that you need the SAMP block (described next).

Block Parameters

Table 5.12 lists the CONS block parameters and the units or format in which they are expressed.

Mnemonic	Parameter	Format*
ST	Block Status	HHHH
1K	Constant 1	±Eng.
2K	Constant 2	±Eng.
3K	Constant 3	±Eng.
4K	Constant 4	±Eng.

Table 5.12 CONS Block Parameters

The parameters are detailed in the sections that follow.

*See Table 4.2 for an explanation of these formats

ST Block Status

Figure 5.12 shows the meanings of each of the hexadecimal digits in the ST parameter of the CONS block. (The symbols used in the parameter diagram are explained in Figure 4.2.)

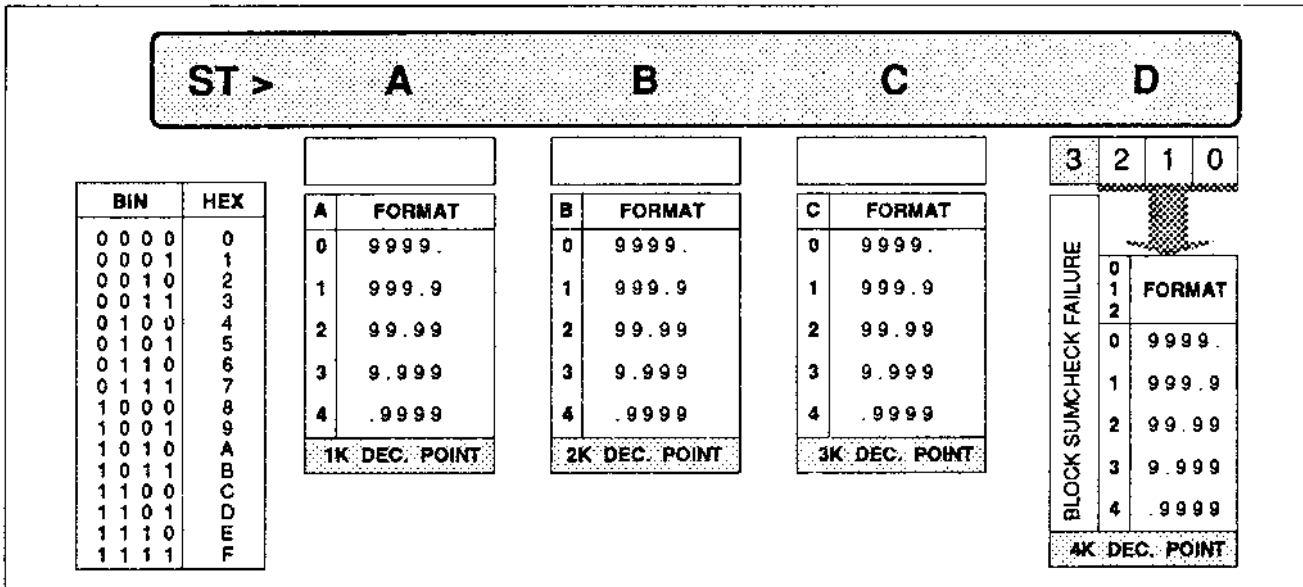

Figure 5.12 ST Parameter — CONS Block

Bit 3 of digit D automatically latches to logic 1 whenever the CPU detects a sumcheck error in any of the CONS block parameters. Also, the block's sumcheck error digital output SC, normally at logic 0, sets to logic 1 when this happens.

To clear this condition, re-enter any corrupted parameters, and then reset bit 3 to logic 0. The SC output follows bit 3 and also resets to logic 0.

1K, 2K, 3K, 4K Constants

You can use the four constants parameters in your control program by connecting them as inputs to other blocks. They can lie in the range 0 to ±9999 with decimal point positions set by the ST parameter.

CONSTANTS BLOCKS

SAMP: READ/WRITE CONSTANTS

Block Connections

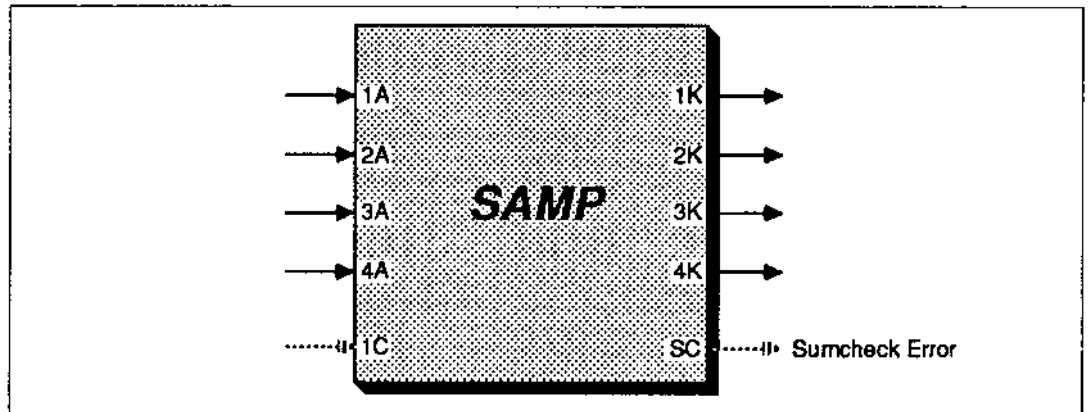

Figure 5.13 SAMP Block Connections

The SAMP block (Figure 5.13) lets you store and update four constants (per block) in the instrument, which you can use in your control strategy. The constants can be updated via the Hand-Held Terminal or RS422 data link, or from within the control strategy itself, via inputs 1A to 4A (when the digital switch 1C is 'on'). Their decimal point positions are set by the ST parameter.

Block Parameters

Table 5.13 lists the SAMP block parameters and the units or format in which they are expressed.

Mnemonic	Parameter	Format*
ST	Block Status	HHHH
1K	Constant 1	±Eng.
2K	Constant 2	±Eng.
3K	Constant 3	±Eng.
4K	Constant 4	±Eng.
FC	Function Control Register	HHHH

Table 5.13 SAMP Block Parameters

The parameters are detailed in the sections that follow.

*See Table 4.2 for an explanation of these formats

ST Block Status

The ST parameter for the SAMP block exactly corresponds to the CONS block ST parameter. Please refer to Figure 5.12 on page 5.20, and the description that follows it.

1K, 2K, 3K, 4K Constants

You can use the four constants parameters in your control strategy by connecting them as inputs to other blocks. They can lie in the range 0 to ± 9999 with decimal point positions set by the ST parameter.

While digital input 1C is held at logic 1, constants 1K to 4K are updated every loop repeat time by the values applied to analogue inputs 1A to 4A respectively. While 1C is at logic 0, the four constants hold steady values which are unaffected by changes to the block inputs.

NOTE 1. ST fixes the decimal point positions of the constants 1K to 4K, but not those of the corresponding block inputs 1A to 4A, which may or may not be the same (depending on their source). If they do not correspond, the *stored* value of a constant may be different from the *input* value.

E.g. 1A = 123. (zero decimal places) updates 1K with the true value only if 1K is also set to zero (or one) decimal places. But if 1K is set to 2 decimal places it stores as only 99.99, which is as close as the decimal places allow.

NOTE 2. Constants 1K to 4K are limited to maxima of 4 significant figures and 4 decimal places in the range ± 9999 , whereas corresponding inputs 1A to 4A can have any floating point value between $\pm 10^{38}$. If your control strategy tries to update a constant with a value having more than 4 significant figures, the value stored truncates to these limits, without any warning.

FC Function Control Register

The FC parameter is explained on page 4.19. Please refer there for details.

ASSIGNED BLOCKS

LOGIC BLOCKS: GATES

AND2: AND

OR2: OR

XOR2: XOR

AND4: AND (4-INPUT)

OR4: OR (4-INPUT)

NOT: NOT

LTCH: LATCH

Block Connections

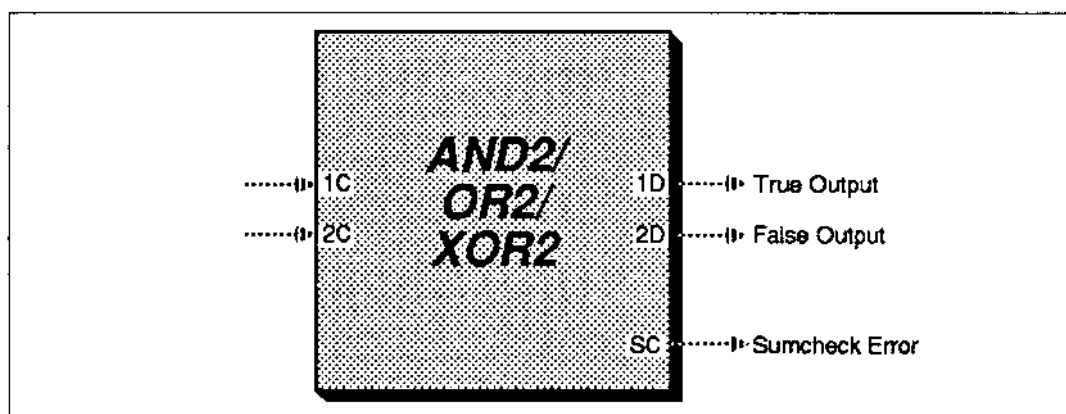

Figure 5.14 Connections for Gate Blocks (2-Inputs)

AND2, OR2, XOR2. These blocks have two digital inputs and two digital outputs (as well as a sumcheck error output), as shown in Figure 5.14. They carry out basic logical operations on the pair of digital inputs, producing a logical (0 or 1) 'true' output at 1D, and its 'false' inverse at 2D. That is, $2D = \overline{1D}$.

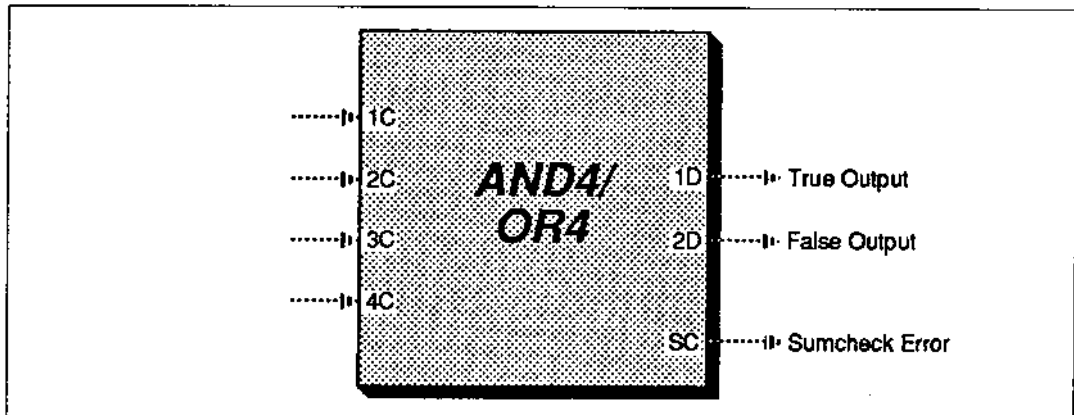

Figure 5.15 *AND4 & OR4 Block Connections*

AND4, OR4. The AND4 and OR4 blocks have four inputs (see Figure 5.15), but are otherwise the same as the AND2 and OR2 blocks, respectively.

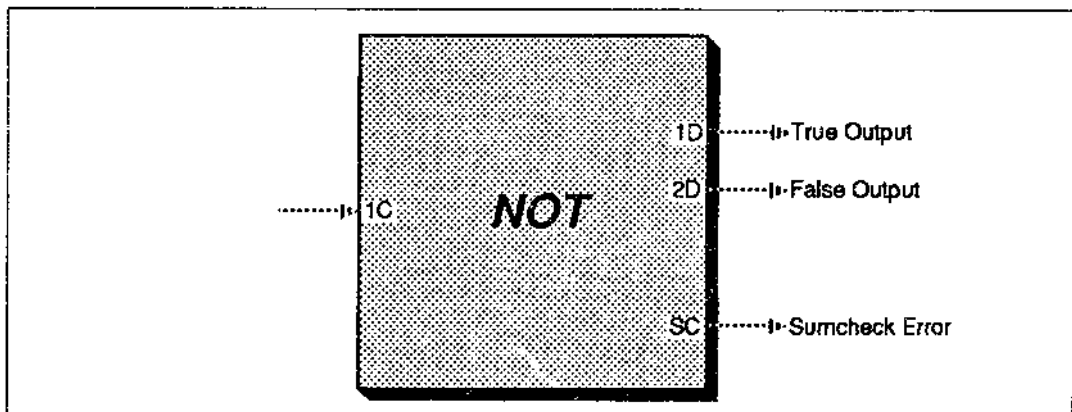

Figure 5.16 *NOT Block Connections*

NOT. The NOT block (see Figure 5.16) simply inverts a digital input.

NOTE. Block names with less than four letters are actually followed by *spaces* to make them up to the standard four characters. You must key these spaces into the Hand-Held Terminal when entering 'short' block names, otherwise the instrument won't accept them.

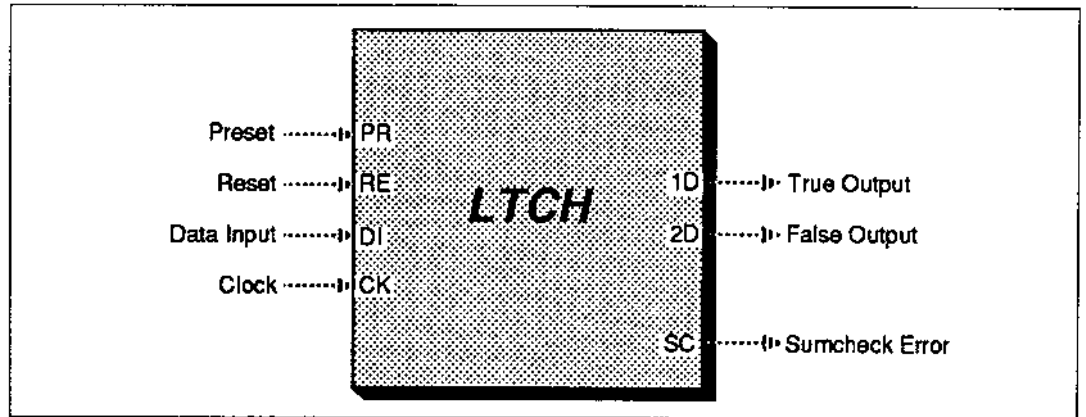

Figure 5.17 LTCH Block Connections

LTCH. The Latch block provides a digital storage element which can be edge or level toggled. A simple example of its use is as a *switch*, toggling on and off with each pulse input. For this, connect the 2D output back to the DI input. Now, provided the PR and RE inputs are both low, every rising edge input via CK causes the 1D output to change state. PR and RE can be used to initialise the switch output, or to lock it 'on' or 'off'.

Block Functions

- AND2 Block.** $1D = 1C \text{ AND } 2C$
- OR2 Block.** $1D = 1C \text{ OR } 2C$
- XOR2 Block.** $1D = 1C \text{ XOR } 2C$
- AND4 Block.** $1D = 1C \text{ AND } 2C \text{ AND } 3C \text{ AND } 4C$
- OR4 Block.** $1D = 1C \text{ OR } 2C \text{ OR } 3C \text{ OR } 4C$
- NOT Block.** $1D = \text{NOT } 1C$
- LTCH Block.** The following truth table defines the action of the LTCH block.

PR	RE	DI	CK	1D	2D
1	0	X	X	1	0
0	1	X	X	0	1
1	1	X	X	no change	
0	0	0	↑	0	1
0	0	1	↑	1	0

X = Don't care
 ↑ = Rising edge

For all blocks: $2D = \overline{1D}$

Block Parameters

Table 5.14 lists the Logic blocks parameters and the units or format in which they are expressed.

Mnemonic	Parameter	Format*
ST	Block Status	HHHH
FC	Function Control Register	HHHH

Table 5.14 *Logic Blocks Parameters*

The Logic blocks' parameters ST and FC correspond exactly to the parameters of the Trigonometric blocks, which are described on page 5.9 in the Maths Blocks section. Please refer there for details.

*See Table 4.2 for an explanation of these formats

ASSIGNED BLOCKS

LOGIC BLOCKS: COMPARATORS

GT: GREATER THAN

LT: LESS THAN

Block Connections

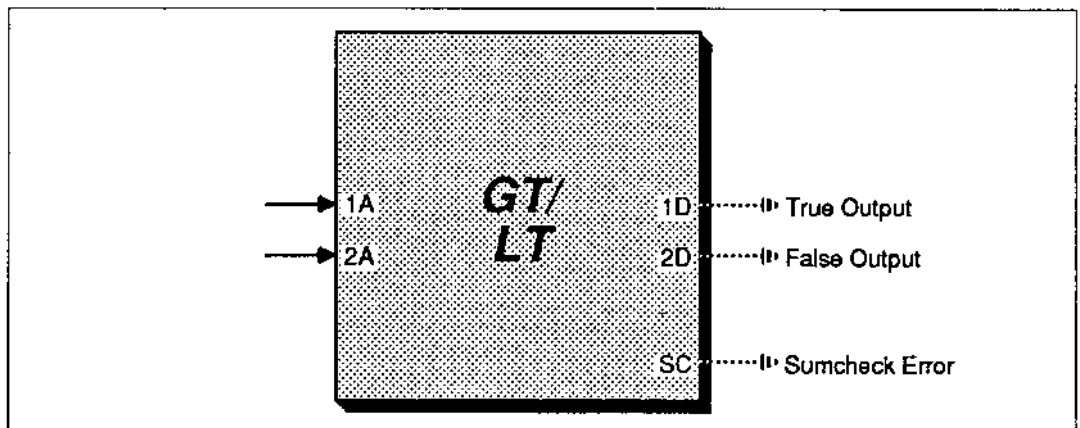

Figure 5.18 GT/LT Block Connections

Comparator blocks (Figure 5.18) compare two analogue inputs, and output a logical (0 or 1) 'true' output at 1D, and its 'false' inverse at 2D. That is, $2D = \overline{1D}$.

NOTE. Block names with less than four letters are actually followed by *spaces* to make them up to the standard four characters. You must key these spaces into the Hand-Held Terminal when entering 'short' block names, otherwise the instrument won't accept them.

Block Functions

In the following, the prime symbol (') indicates a *scaled* value, e.g. $1A' = 1K \times 1A$.

GT Block. $1D = 1A' \text{ GREATER THAN } 2A'$

LT Block. $1D = 1A' \text{ LESS THAN } 2A'$

For all blocks: $2D = \overline{1D}$

Block Parameters

Table 5.15 lists the GT and the LT blocks' parameters and the units or format in which they are expressed.

Mnemonic	Parameter	Format*
ST	Block Status	HHHH
1K	Scaling Constant for 1A	±Eng.
2K	Scaling Constant for 2A	±Eng.
HY	Hysteresis	Eng.
FC	Function Control Register	HHHH

Table 5.15 GT and LT Blocks Parameters

The GT and LT blocks' parameters ST, 1K, 2K, and FC correspond exactly to the parameters of the Arithmetic blocks, which are described on page 5.6 in the Maths Blocks section. Please refer there for details

ST Block Status

Figure 5.19 shows the meanings of each of the hexadecimal digits in the ST parameter of the GT and LT blocks. (The symbols used in the parameter diagram are explained in Figure 4.2.)

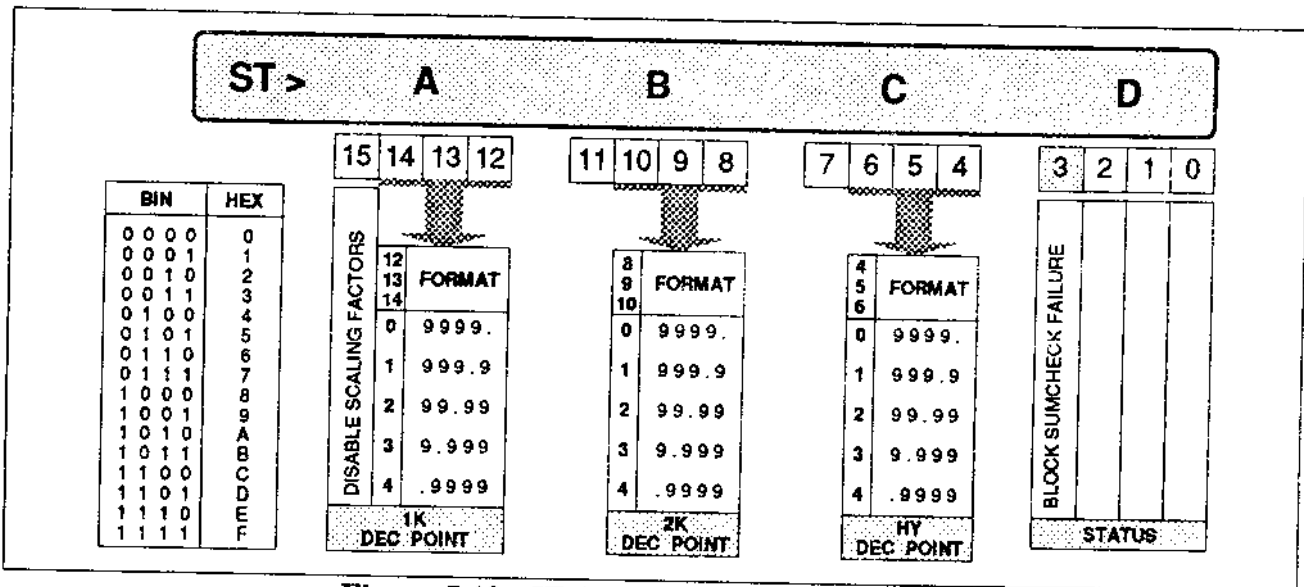

Figure 5.19 ST Parameters — GT/LT Blocks

Decimal Point Selection — Digits A to C

The least significant three bits of digits A to C set the decimal point positions for the 1K, 2K, and HY parameters respectively.

*See Table 4.2 for an explanation of these formats

HY Hysteresis

The Hysteresis parameter HY defines in engineering units the 'tolerance band' the GT and LT blocks allow when comparing two analogue inputs. Hysteresis is applied *asymmetrically*; i.e. it depends on the direction from which equality of the two inputs is approached. Figures 5.20 and 5.21 show for the GT and LT blocks, respectively, how the 1D 'true' output switches between 0 and 1 as the difference between the inputs ($1A' - 2A'$) varies.

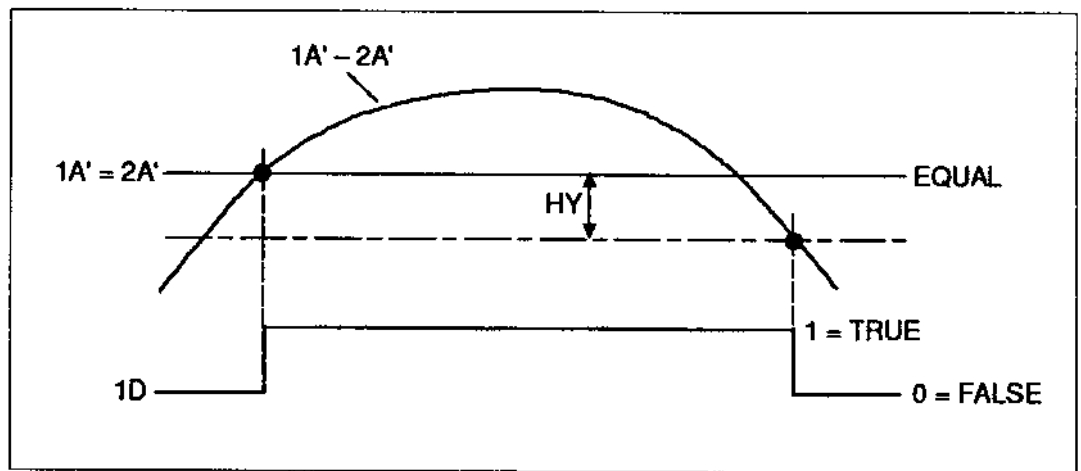

Figure 5.20 GT Block — Application of Hysteresis

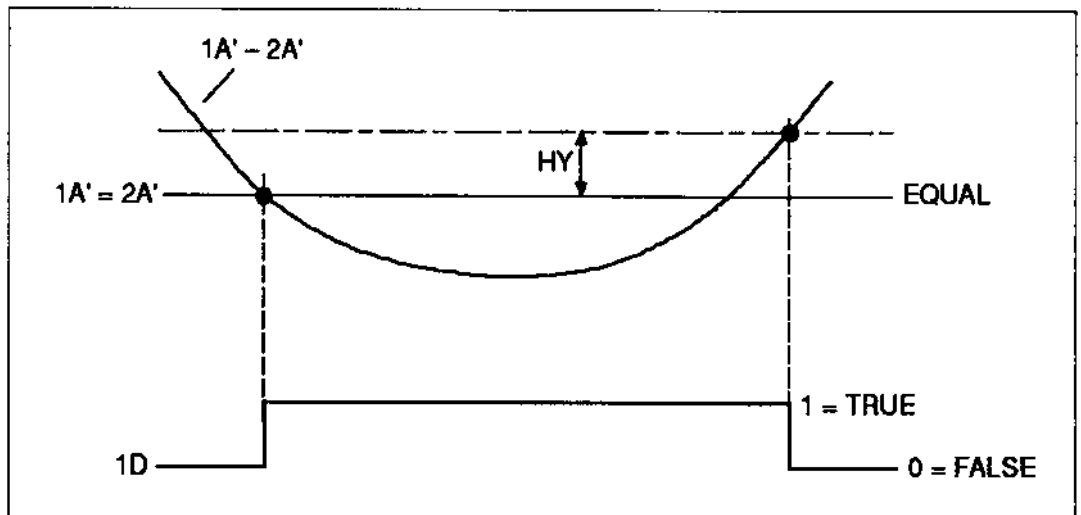

Figure 5.21 LT Block — Application of Hysteresis

LOGIC BLOCKS: COMPARATORS

EU: EQUAL

Block Connections

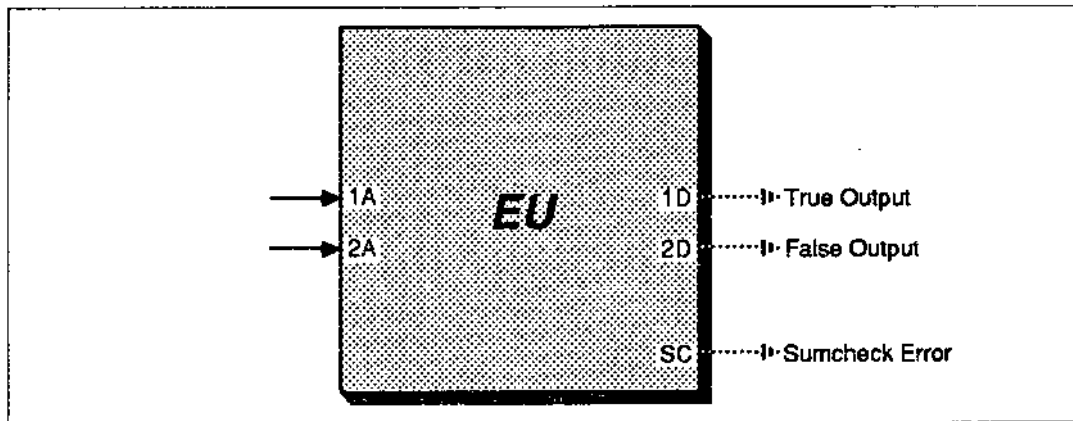

Figure 5.22 EU Block Connections

The EU block (Figure 5.22) compares two analogue inputs, and outputs a logical (0 or 1) 'true' outputs at 1D, and its 'false' inverse at 2D. That is, $2D = \overline{1D}$.

NOTE. Block names with less than four letters are actually followed by *spaces* to make them up to the standard four characters. You must key these spaces into the Hand-Held Terminal when entering 'short' block names, otherwise the instrument won't accept them.

Block Functions

In the following, the prime symbol (') indicates a *scaled* value, e.g. $1A' = 1K \times 1A$.

EU Block. $1D = 1A' \text{ EQUAL TO } 2A'$

For all blocks: $2D = \overline{1D}$

Block Parameters

Table 5.16 lists the EU block's parameters and the units or format in which they are expressed.

Mnemonic	Parameter	Format*
ST	Block Status	HHHH
1K	Scaling Constant for 1A	±Eng.
2K	Scaling Constant for 2A	±Eng.
HY	Hysteresis	Eng.
EB	Equal Band	Eng.
FC	Function Control Register	HHHH

Table 5.16 EU Block Parameters

The EU block parameters 1K, 2K, and FC correspond exactly to the Arithmetic blocks, which are described on page 5.7 in the Maths Blocks section. Please refer there for details

ST Block Status

Figure 5.23 shows the meanings of each of the hexadecimal digits in the ST parameter of the EU block. (The symbols used in the parameter diagram are explained in Figure 4.2.)

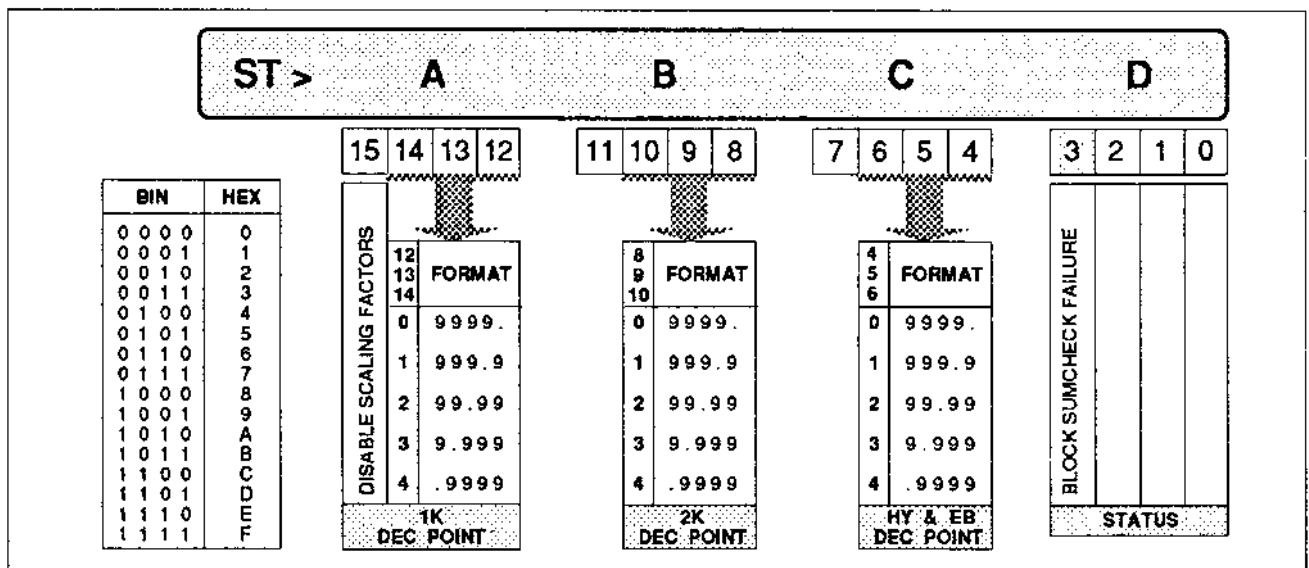

Figure 5.23 ST Parameters — EU Block

*See Table 4.2 for an explanation of these formats

Decimal Point Selection — Digits A to C

The least significant three bits of digits A and B set the decimal point positions for the 1K and 2K parameters respectively. Those of digit C set the (common) decimal point position for both the HY and EB parameters.

HY Hysteresis

The Hysteresis parameter HY defines in engineering units an outer 'tolerance band', added on top of the Equal Band (see next section), that the EU block allows when comparing two analogue inputs. Hysteresis is applied *asymmetrically*; i.e. it depends on the direction from which equality of the two inputs is approached.

EB Equal Band

The Equal Band parameter EB defines in engineering units an inner 'tolerance band' the EU block allows when comparing two analogue inputs. Hysteresis (see previous section) is applied on top of the Equal Band. Unlike hysteresis, the Equal Band is applied *symmetrically*; i.e. it is independent of the direction from which equality of the two inputs is approached.

Figure 5.24 shows how the 1D 'true' output switches between 0 and 1 as the difference between the inputs ($1A' - 2A'$) varies.

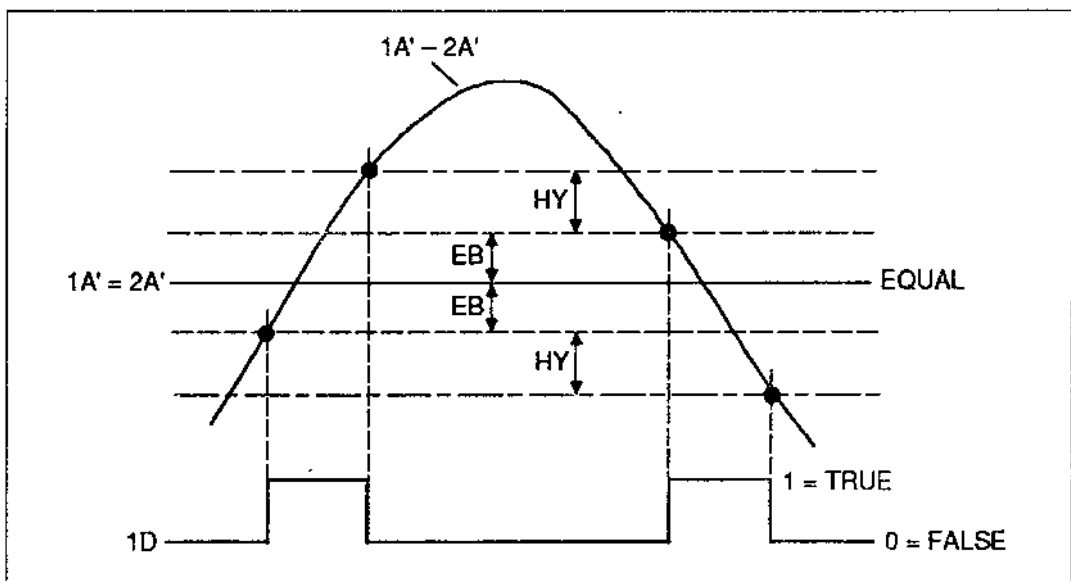

Figure 5.24 EU Block — Application of Equal Band & Hysteresis

ASSIGNED BLOCKS

SELECTOR BLOCKS

HSL2: HIGH SELECT

LSL2: LOW SELECT

Block Connections

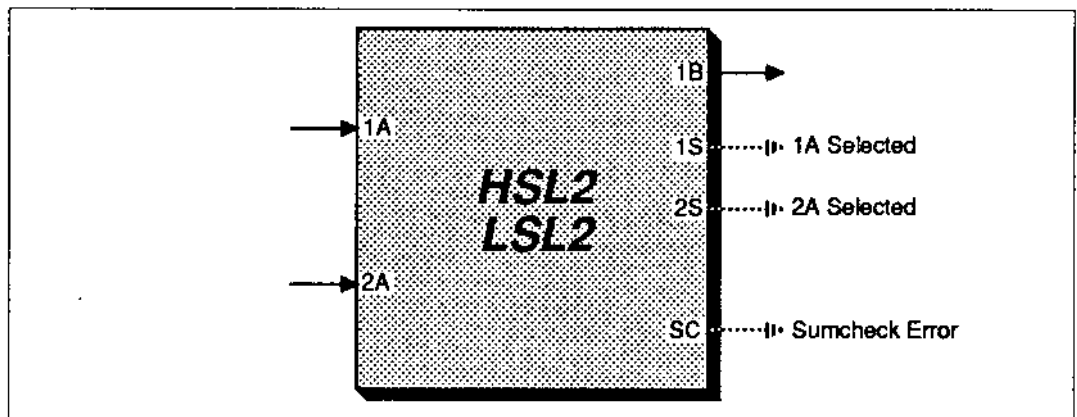

Figure 5.25 Selector Block Connections (2-input type)

The High (HSL2) and Low (LSL2) Select blocks let you compare two scaled signals and output the higher or lower, respectively. Digital output 1S (with inverse 2S) indicates which signal has been selected by the block for output.

Block Functions

In the following, the prime symbol (') indicates a *scaled* value, e.g. $1A' = 1K \times 1A$. Also, $2S = \text{NOT-}1S$.

HSL2 Block. IF $1A' > 2A'$ THEN $1B = 1A'$, $1S = 1$
ELSE $1B = 2A'$, $1S = 0$

LSL2 Block. IF $1A' < 2A'$ THEN $1B = 1A'$, $1S = 1$
ELSE $1B = 2A'$, $1S = 0$

NOTE. You may disable the scaling constants by setting bit 15 of the ST parameter to 1. Please refer to the parameter details.

Block Parameters

Table 5.17 lists the Selector blocks parameters and the units or format in which they are expressed.

Mnemonic	Parameter	Format*
ST	Block Status	HHHH
1K	Scaling Constant for 1A	±Eng.
2K	Scaling Constant for 2A	±Eng.
FC	Function Control Register	HHHH

Table 5.17 *Selector Blocks Parameters*

The Selector blocks parameters ST, 1K, 2K, and FC correspond exactly to the parameters of the Arithmetic blocks, which are described on page 5.6 in the Maths Blocks section. Please refer there for details.

SELECTOR BLOCKS

MSL3: MEDIAN SELECT

Block Connections

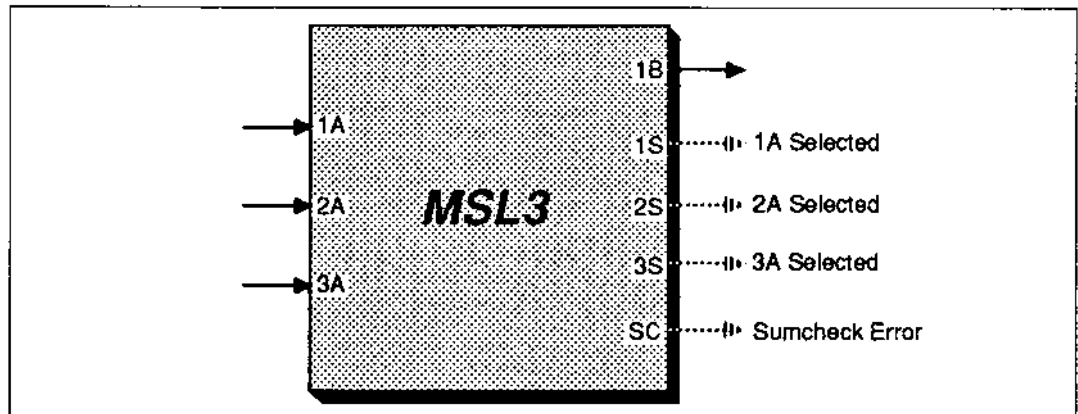

Figure 5.26 MSL3 Block Connections

The Median Select block (MSL3) outputs the middle-valued of three scaled analogue inputs. Digital outputs 1S, 2S, and 3S indicate which of the 1A, 2A, and 3A signals, respectively, has been selected by the block for output.

Block Function

In the following, the prime symbol (') indicates a *scaled* value, e.g. $1A' = 1K \times 1A$.

MSL3 Block.

```

IF 1A' > 2A'
    THEN IF 2A' > 3A'
        THEN 1B = 2A', 2S = 1, 1S = 3S = 0
        ELSE IF 1A' > 3A'
            THEN 1B = 3A', 3S = 1, 1S = 2S = 0
            ELSE 1B = 1A', 1S = 1, 2S = 3S = 0
    ELSE IF 1A' > 3A'
        THEN 1B = 1A', 1S = 1, 2S = 3S = 0
        ELSE IF 2A' > 3A'
            THEN 1B = 3A', 3S = 1, 1S = 2S = 0
            ELSE 1B = 2A', 2S = 1, 1S = 3S = 0
    
```

NOTE. You may disable the scaling constants by setting bit 15 of the ST parameter to 1. Please refer to the parameter details.

Block Parameters

Table 5.18 lists the MSL3 block parameters and the units or format in which they are expressed.

Mnemonic	Parameter	Format*
ST	Block Status	HHHH
1K	Scaling Constant for 1A	±Eng.
2K	Scaling Constant for 2A	±Eng.
3K	Scaling Constant for 3A	±Eng.
FC	Function Control Register	HHHH

Table 5.18 MSL3 Block Parameters

The Median Select block parameters 1K, 2K, and FC correspond exactly to the parameters of the other selector blocks HSL2, and LSL2, previously described. The 3K parameter is the scaling constant for the 3A input, with decimal point position selected by digit C of the ST parameter.

ST Status Block

Figure 5.27 shows the meanings of each of the hexadecimal digits in the ST parameter of the MSL3 block. (The symbols used in the parameter diagram are explained in Figure 4.2.)

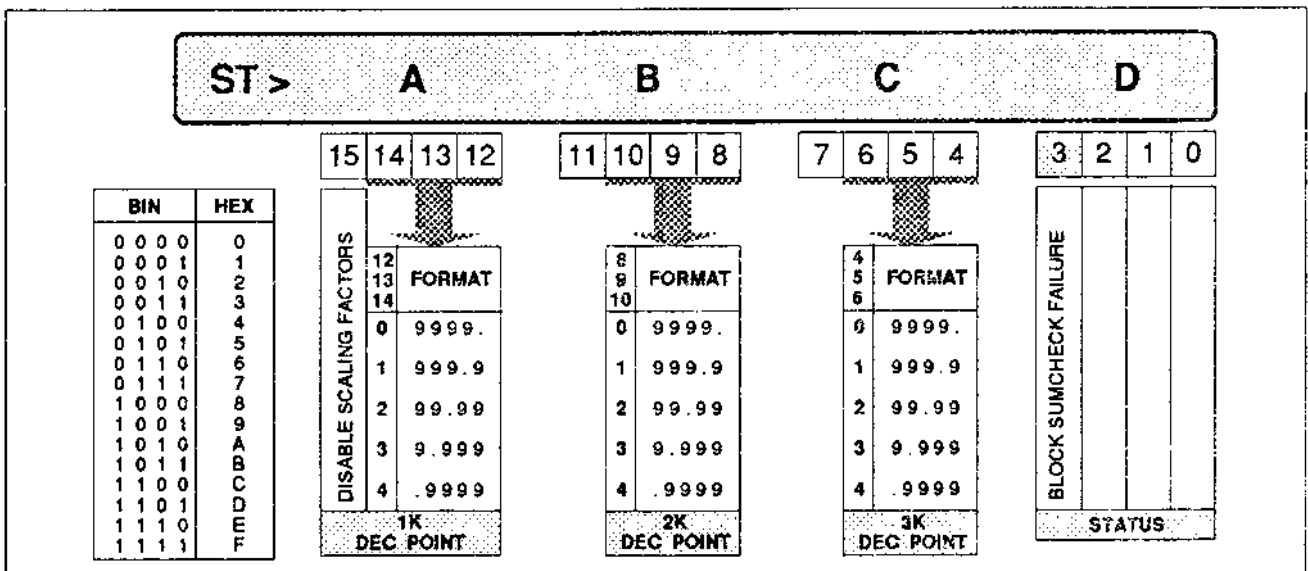

Figure 5.27 ST Parameters—MSL3 Block

SELECTOR BLOCKS

SLCT: SELECT

Block Connections

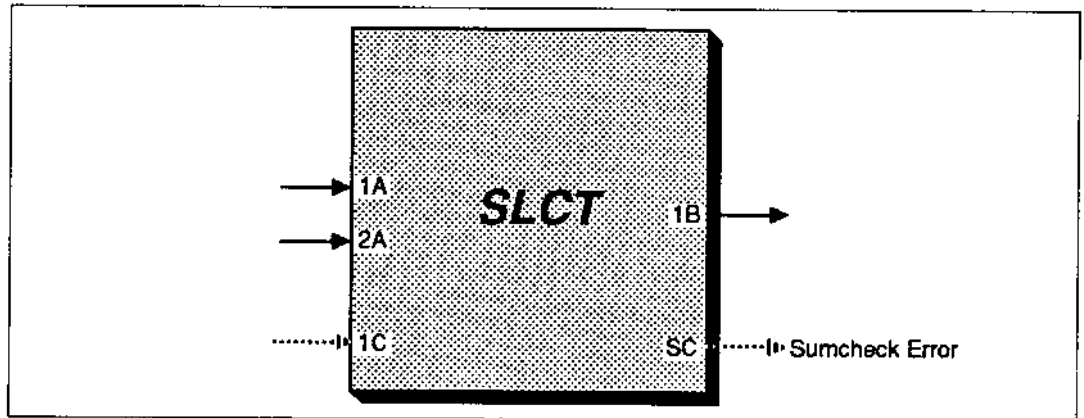

Figure 5.28 SLCT Block Connections

The SLCT block lets you select between outputting one of two scaled analogue inputs, using a digital input as the 'toggle'. See Figure 5.28.

Block Function

In the following, the prime symbol (') indicates a *scaled* value, e.g. $1A' = 1K \times 1A$.

SLCT Block. IF $1C = 1$ THEN $1B = 1A'$
 ELSE $1B = 2A'$

NOTE. You may disable the scaling constants by setting bit 15 of the ST parameter to 1. Please refer to the parameter details.

Block Parameters

Table 5.19 lists the SLCT block parameters and the units or format in which they are expressed.

Mnemonic	Parameter	Format*
ST	Block Status	HHHH
1K	Scaling Constant for 1A	±Eng.
2K	Scaling Constant for 2A	±Eng.
FC	Function Control Register	HHHH

Table 5.19 *SLCT Block Parameters*

The SLCT block parameters ST, 1K, 2K, and FC correspond exactly to the parameters of the Arithmetic blocks, which are described on page 5.6 in the Maths Blocks section. Please refer there for details.

ASSIGNED BLOCKS

TIME BLOCKS

RATE : RATE LIMIT

Block Function

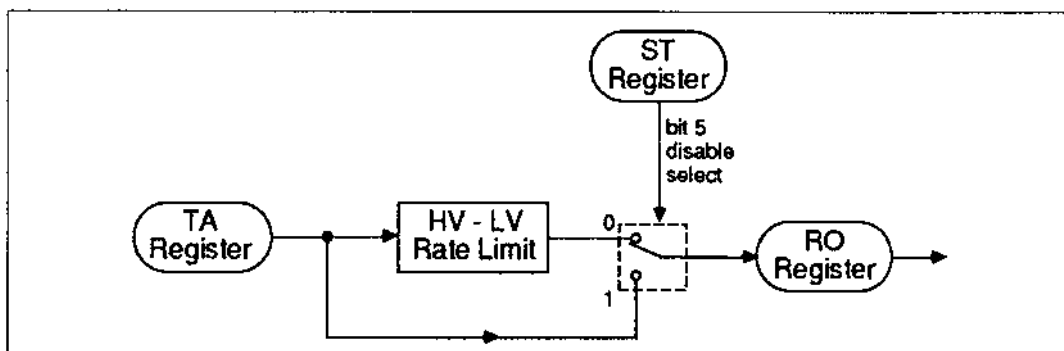

Figure 5.29 Rate Block Schematic

Please refer to Figure 5.29. The RATE block limits the rate of change of an analogue output RO as it tries to follow a dynamic variable TA, the target value input. A digital input (also ST bit 5) allows you to disable the limiting action. Incremental and decremental rates are separately set, via HV and LV respectively.

Block Connections

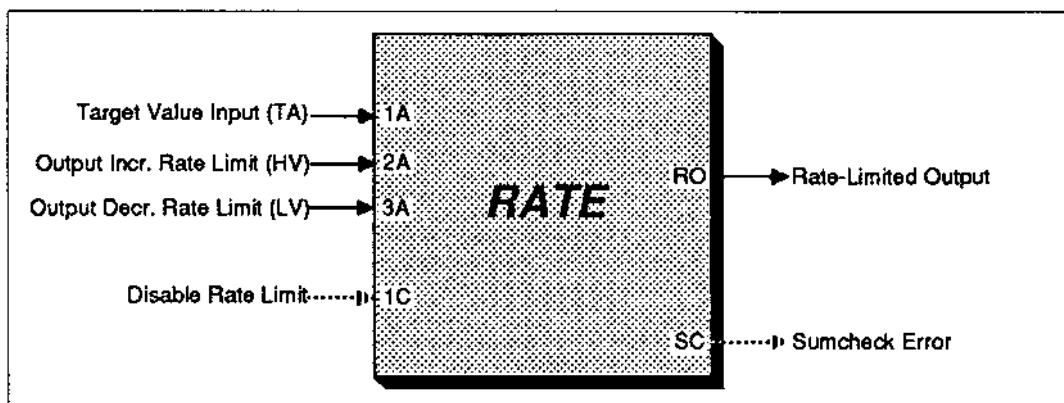

Figure 5.30 RATE Block Connections

Figure 5.30 represents the RATE block incoming and outgoing connections. The two-letter mnemonics in brackets are the parameters accessed by the connections.

NOTE. If left unconnected the parameters can be set via the HHT or RS422 data link.

Incoming Connections. The connections coming into the RATE block are summarised in Table 5.20.

Code	Connection	Function	Format*
1A	To TA parameter	Target Value Input	FP
2A	To HV parameter	Output Incremental Rate Limit	FP
3A	To LV parameter	Output Decremental Rate Limit	FP
1C		Disable Rate Limit	0/1

Table 5.20 *RATE Incoming Connections*

Outgoing Connections. Table 5.21 summarises the outgoing connections from the RATE block.

Code	Connection	Function	Format*
RO	Output data	Rate-Limited output	FP.
SC	Sumcheck Error	Latches to 1 on sumcheck failure	0/1

Table 5.21 *RATE Outgoing Connections*

Block Parameters

Table 5.22 lists the RATE block parameters and the units or format in which they are expressed.

Mnemonic	Parameter	Format*
ST	Block Status	HHHH
HV	Output Incremental Rate Limit	Eng./s
LV	Output Decremental Rate Limit	Eng./s
TA	Target Value Input	±Eng.
RO	Rate-Limited Block Output	±Eng.
FC	Function Control Register	HHHH

Table 5.22 *RATE Block Parameters*

These parameters are covered in more detail in the sections that follow.

*See Table 4.2 for an explanation of these formats

ST Block Status

Figure 5.31 shows the meanings of the hexadecimal digits in the ST parameter of the Rate Limit block. (The symbols used in the parameter diagram are explained in Figure 4.2.)

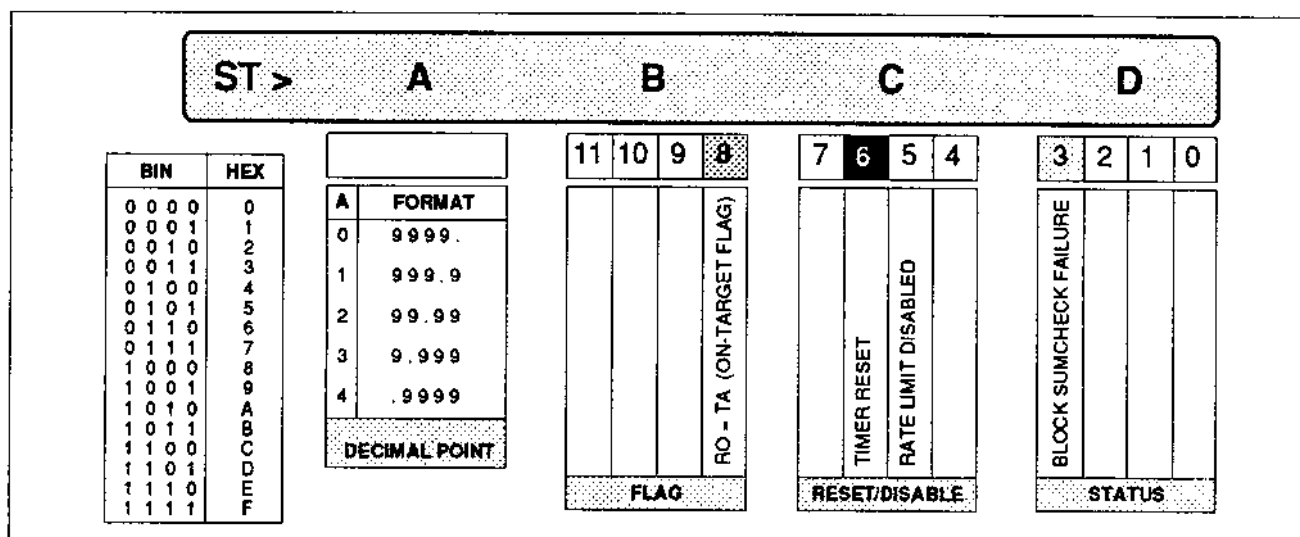

Figure 5.31 ST Parameter — Rate Block

Decimal Point Selection — Digit A

Digit A selects the decimal point position for the HV, LV, TA, and RO parameters.

On-Target Flag — Digit B

Read-only bit 8 sets to logic 1 whenever RO = TA, i.e. when the target output value is attained.

Timer Reset & Rate Limit Disable — Digit C

Set bit 6 to logic 1 to initialise the block's internal timer (done automatically at power up or program start). Bit 6 is write-only, and always reads back as logic 0.

Set bit 5 to logic 1 to disable the rate-limiting action and cause RO to track TA. Bit 5 is also set by logic 1 input to the block's digital input 1C.

Block Status — Digit D

Bit 3 of digit D automatically latches to logic 1 whenever the CPU detects a sumcheck failure in any of the parameters of the RATE block. To clear this condition, re-enter any corrupted parameters, and then write a zero to bit 3.

HV & LV Output Incremental & Decremental Rate Limits

HV (Incremental Rate Limit parameter) defines in engineering units per second the maximum rate at which the block's analogue output RO is allowed to *increase*. Similarly, LV (the Decremental Rate Limit parameter) defines the maximum rate at which RO is allowed to *decrease*.

TA Target Value

TA is the target value, in engineering units, input to the block. When TA is changed, RO is allowed to reach the new TA value at a rate limited by the HV and LV parameters.

RO Output Value

RO is the block's rate-limited analogue output value.

FC Function Control Register

The FC parameter is explained on page 4.19. Please refer there for details.

TIME BLOCKS

RAMP

Block Function

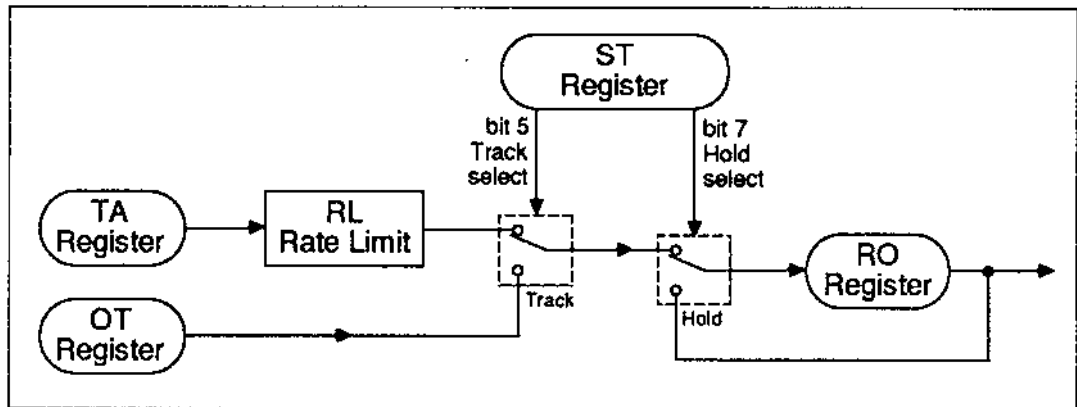

Figure 5.32 Ramp Block Schematic

Please refer to Figure 5.32. The RAMP block generates a ramp signal by using RL to control the rate of change of analogue output RO as it approaches TA, the target value input. Digital inputs (and also two ST bits) let you set the block to Track (OT), or Hold. A digital output flags the 'on target' (RO = TA) condition.

Block Connections

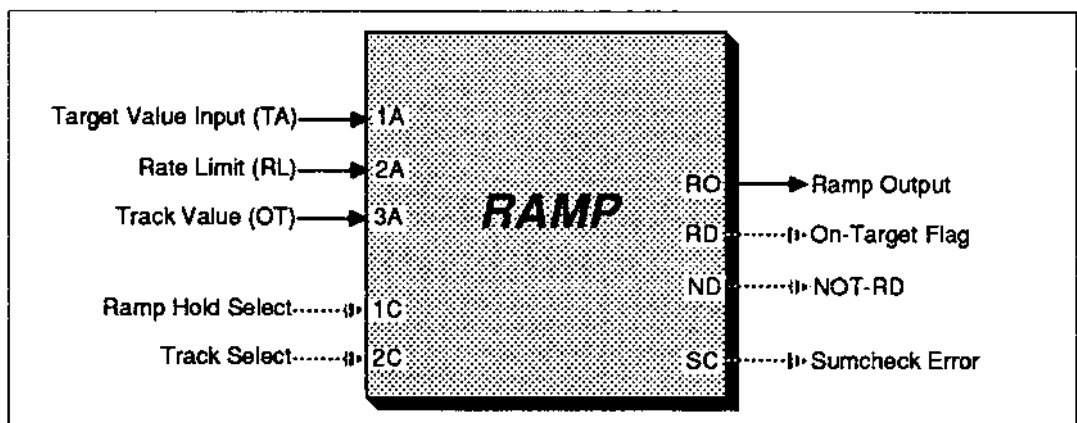

Figure 5.33 RAMP Block Connections

Figure 5.33 represents the RAMP block incoming and outgoing connections. The two-letter mnemonics in brackets are the parameters accessed by the connections.

NOTE. If left unconnected the parameters can be set via the HHT or RS422 data link.

Incoming Connections. The connections coming into the RAMP block are summarised in Table 5.23.

Code	Connection	Function	Format*
1A	To TA parameter	Target Value Input	FP
2A	To RL parameter	Rate Limiting Value	FP
3A	To OT parameter	Track Value	FP
1C		HOLD select (sets ST bit 7)	0/1
2C		TRACK select (sets ST bit 6)	0/1

Table 5.23 RAMP Incoming Connections

Outgoing Connections. Table 5.24 summarises the outgoing connections from the RAMP block.

Code	Connection	Function	Format*
RO	Output data	Rate-Limited Ramp Signal	FP
RD	On-Target Flag	Set when RO = TA	0/1
ND	NOT-RD	Set when RO \neq TA	0/1
SC	Sumcheck Error	Latches to 1 on sumcheck failure	0/1

Table 5.24 RAMP Outgoing Connections

Block Parameters

Table 5.25 lists the RAMP block parameters and the units or format in which they are expressed.

Mnemonic	Parameter	Format*
ST	Block Status	HHHH
RL	Output Rate Limit	Eng./s
OT	Track Value	\pm Eng.
TA	Target Value Input	\pm Eng.
RO	Ramp Output	\pm Eng.
FC	Function Control Register	HHHH

Table 5.25 RAMP Block Parameters

These parameters are covered in more detail in the sections that follow.

*See Table 4.2 for an explanation of these formats

ST Block Status

Figure 5.34 shows the meanings of the hexadecimal digits in the ST parameter of the Ramp block. (The symbols used in the parameter diagram are explained in Figure 4.2.)

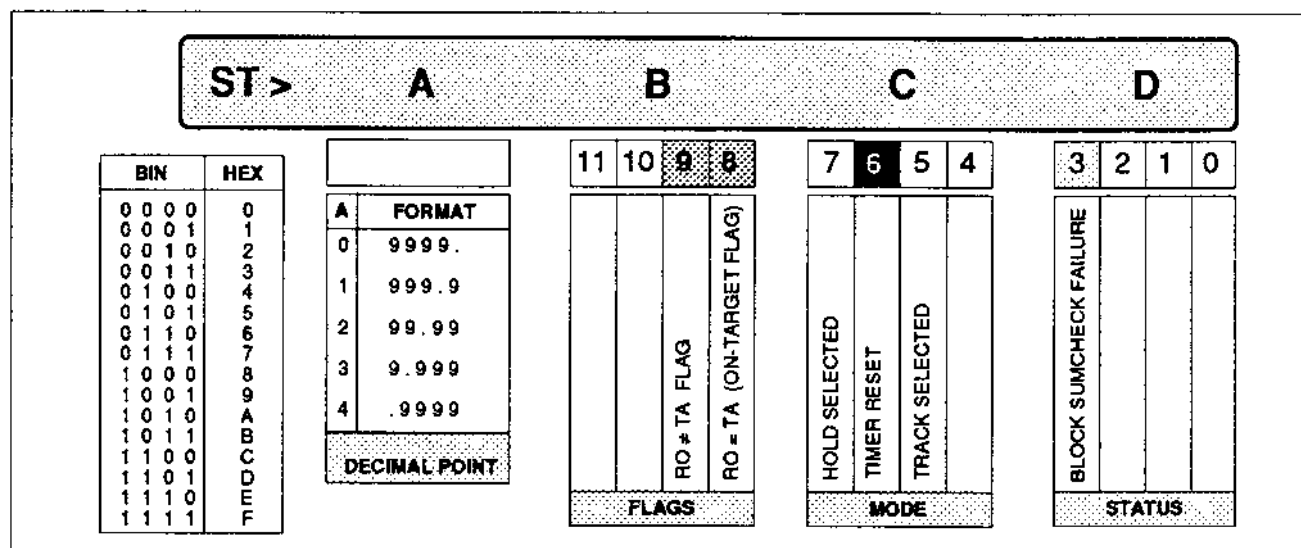

Figure 5.34 ST Parameter — Ramp Block

Decimal Point Selection — Digit A

Digit A selects the decimal point position for the TA, RL, OT, and RO parameters.

On-Target Flags — Digit B

Read-only bit 8 sets to logic 1 whenever RO = TA, i.e. when the target output value is attained. The block's digital output RD, the on-target flag, sets to logic 1 at the same time. Bit 9 is the inverse of bit 8, setting to logic 1 when RO ≠ TA, and output ND is the inverse of RD, acting as an 'off-target' flag. These bits are 'frozen' when the block is in HOLD or TRACK.

Hold/Track Selects & TimerReset — Digit C

Setting bit 7 to logic 1 selects HOLD, causing the current RO value to freeze. Setting bit 5 selects TRACK, when RO tracks the OT parameter. (Digital inputs 1C and 2C can be used to set these ST bits).

Set bit 6 to logic 1 to initialise the block's internal timer (done automatically at power up or program start). Bit 6 is write-only, and always reads back as logic 0.

Block Status — Digit D

Bit 3 of digit D automatically latches to logic 1 whenever the CPU detects a sumcheck failure in any of the parameters of the RAMP block. To clear this condition, re-enter any corrupted parameters, and then write a zero to bit 3.

RL Rate Limit

RL (the Rate Limit parameter) defines in engineering units per second the rate at which the block's analogue output RO ramps up ($TA > RO$) or down ($TA < RO$) as it approaches the target value TA. RL must have a positive value.

TA Target Value

TA is the ramp target value, in engineering units. When TA is changed, RO is allowed to reach the new TA value at a rate set by the RL parameter.

OT Track Value

OT is the ramp track value, in engineering units. With TRACK selected (via ST or digital input 1C), RO follows the OT parameter value, ignoring RL.

RO Output Value

RO is the block's ramp output analogue value.

FC Function Control Register

The FC parameter is explained on page 4.19. Please refer there for details.

ASSIGNED BLOCKS

TIME BLOCKS

TIME : TIMER

Block Function

The TIME block is a resettable incremental UP timer, outputting current time and a digital flag on reaching the preset End Time value, when the timer stops. Seconds, minutes, or hours may be preselected via the ST parameter.

Block Connections

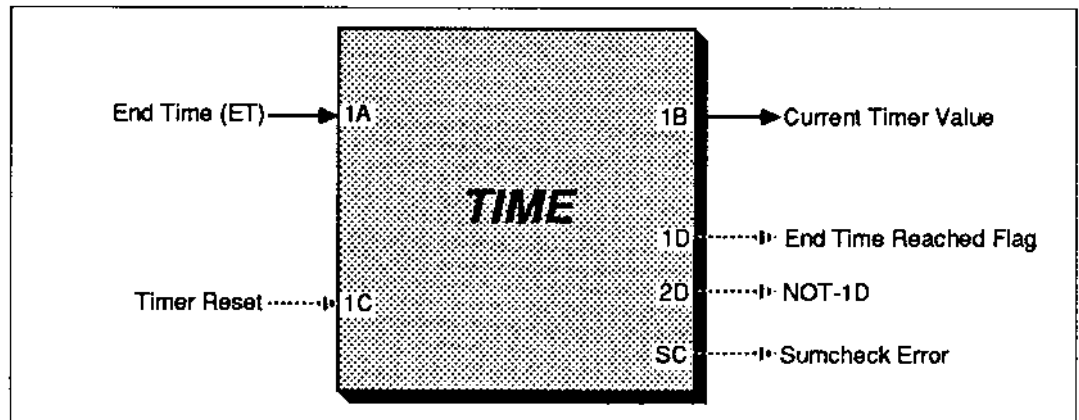

Figure 5.35 TIME Block Connections

Figure 5.35 represents the TIME block incoming and outgoing connections. The two-letter mnemonics in brackets are the parameters accessed by the connections

NOTE. If left unconnected the parameters can be set via the HHT or RS422 data link.

Incoming Connections. The connections coming into the TIME block are summarised in Table 5.26.

Code	Connection	Function	Format*
1A	To ET parameter	End-Time value	FP
1C	Timer Reset	Resets timer to zero (1B → 0)	0/1

Table 5.26 TIME Incoming Connections

*See Table 4.2 for an explanation of these formats

Outgoing Connections. Table 5.27 summarises the outgoing connections from the TIME block.

Code	Connection	Function	Format*
1B		Current Timer Value (hr/min/sec)	FP
1D	End-time Flag	Set when 1B \geq ET	0/1
2D	NOT-1D	Set when 1B < ET	0/1
SC	Sumcheck Error	Latches to 1 on sumcheck failure	0/1

Table 5.27 *TIME Outgoing Connections*

Block Parameters

Table 5.28 lists the TIME block parameters and the units or format in which they are expressed.

Mnemonic	Parameter	Format*
ST	Block Status	HHHH
ET	End-Time Value	100
FC	Function Control Register	HHHH

Table 5.28 *TIME Block Parameters*

These parameters are covered in more detail in the sections that follow.

*See Table 4.2 for an explanation of these formats

ST Block Status

Figure 5.36 shows the meanings of the hexadecimal digits in the ST parameter of the Timer block. (The symbols used in the parameter diagram are explained in Figure 4.2.)

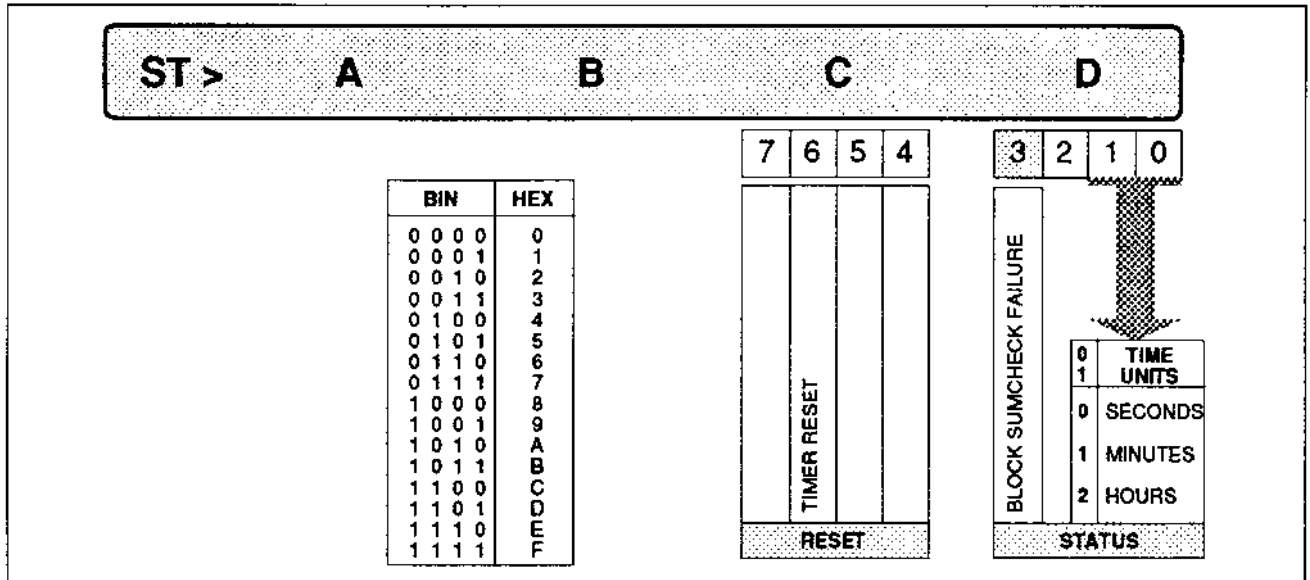

Figure 5.36 ST Parameter — Timer Block

Timer Reset — Digit C

Setting bit 6 to logic 1 resets the timer block. An input to 1C has the same effect.

Block Status & Timer Units — Digit D

Bit 3 of digit D automatically latches to logic 1 whenever the CPU detects a sumcheck failure in any of the parameters of the TIME block. To clear this condition, re-enter any corrupted parameters, and then write a zero to bit 3.

Bits 0 and 1 set the value of the timer units (seconds, minutes, or hours).

ET End-Time

ET defines in the chosen units (set via ST) the time (1B output) at which the timer stops. The digital 1D output goes high when this happens, and 2D goes low.

FC Function Control Register

The FC parameter is explained on page 4.19. Please refer there for details.

TIME BLOCKS

PGNT : PULSE GENERATOR

Block Function

The PGNT block produces a continuous train of rectangular-wave pulses. 'Mark' and 'space' values are individually controlled via a pair of scaled inputs to the block, with minimum values set by parameters.

Block Connections

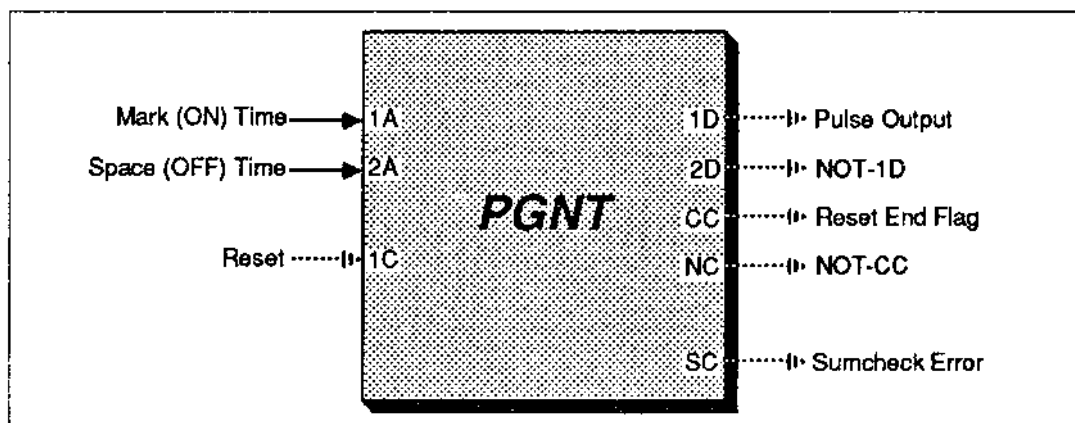

Figure 5.37 PGNT Block Connections

Figure 5.37 represents the PGNT block incoming and outgoing connections.

CAUTION. If you connect the PGNT block's digital pulse outputs to another block, both blocks should be in the *same loop* to avoid data loss due to loop scheduling mismatches. Also, if you use a Digital Output block (DGOP) to output the pulses, it may be unwise to choose the 'Loop 3' background program for this purpose. (Refer to Chapter 9, *Task Scheduling*, for details.)

Incoming Connections. The connections coming into the PGNT block are summarised in Table 5.29.

Code	Connection	Function	Format*
1A		On-Time ('Mark') value limited by MM	FP
2A		Off-Time ('Space') value limited by MS	FP
1C	Block Reset	Resets block output to zero output†	0/1

*See below under ST parameter for details of reset action

Table 5.29 PGNT Incoming Connections

Outgoing Connections. Table 5.30 summarises the outgoing connections from the PGNT block.

Code	Connection	Function	Format*
1D	Pulse Output	Rectangular-wave block output	0/1
2D	NOT-1D	Inverted pulse train	0/1
CC	Reset end flag	Reset cycle complete flag [†]	0/1
NC	NOT-CC	Reset cycle incomplete flag [†]	0/1
SC	Sumcheck Error	Latches to 1 on sumcheck failure	0/1

[†]See below under ST parameter for details of reset action

Table 5.30 *PGNT Outgoing Connections*

Block Parameters

Table 5.31 lists the PGNT block parameters and the units or format in which they are expressed.

Mnemonic	Parameter	Format*
ST	Block Status	HHHH
1K	Scaling Factor for 1A Input	Eng.
2K	Scaling Factor for 2A Input	Eng.
MM	Minimum 'Mark' (ON) Time	100
MS	Minimum 'Space' (OFF) Time	100
FC	Function Control Register	HHHH

Table 5.31 *PGNT Block Parameters*

These parameters are covered in more detail in the sections that follow.

*See Table 4.2 for an explanation of these formats

ST Block Status

Figure 5.38 shows the meanings of the hexadecimal digits in the ST parameter of the Pulse Generator block. (The symbols used in the parameter diagram are explained in Figure 4.2.)

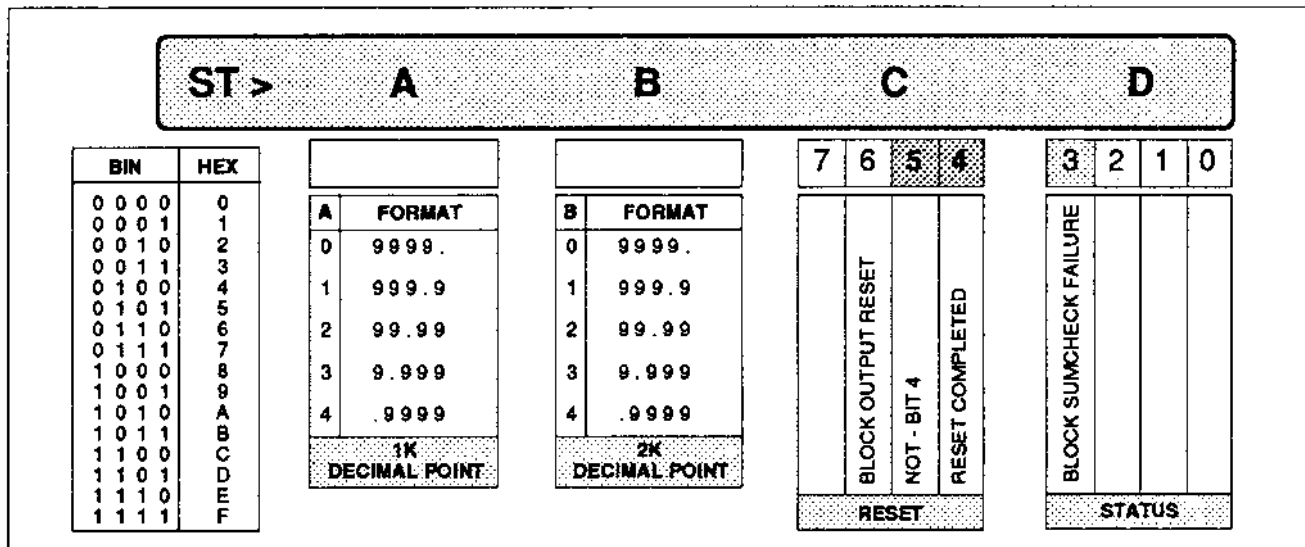

Figure 5.38 ST Parameter — Pulse Generator Block

Decimal Point Selection — Digits A & B

A and B select the decimal point positions for the 1K and 2K scale factor parameters, respectively.

Block Reset — Digit C

Setting bit 6 to logic 1 (or inputting a logic 1 to the block's input 1C) initiates a *reset cycle*, resulting in the 1D pulse train output becoming zero, usually after a delay. Bit 6 is also set automatically at power up or program start.

The aim of the reset cycle is to ensure that, whenever the bit 6 goes high, the pulse train ceases only at the end of a complete high-low cycle, with mark and space times no shorter than MM and MS. (Only if the reset happens to occur in the low part of the pulse train, after MS has elapsed, does the output switch off immediately.) After the reset cycle, if bit 6 is no longer active, the pulse train restarts at the beginning of a mark (ON) pulse.

Bit 4, and block output CC, flag logic 1 when the reset cycle is complete, dropping back to zero after one loop scan time if reset bit 6 is no longer active. Bit 5 and block output NC are the inverses of bit 4 and output CC, respectively.

Figures 5.39 to 5.41 show the reset action when bit 6 goes high at various stages in the pulse train.

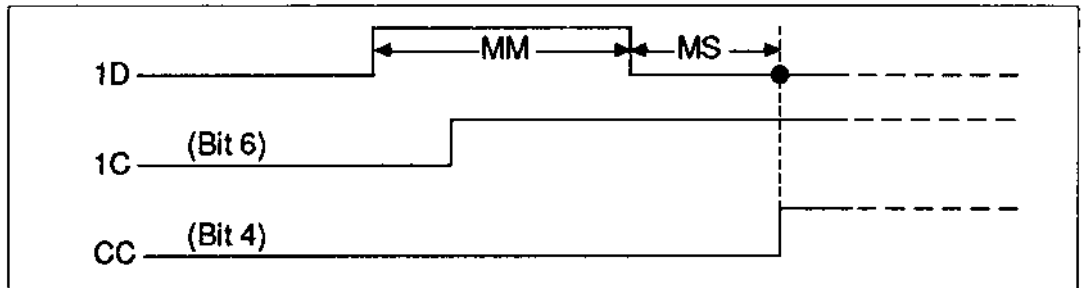

Figure 5.39 Reset During MM

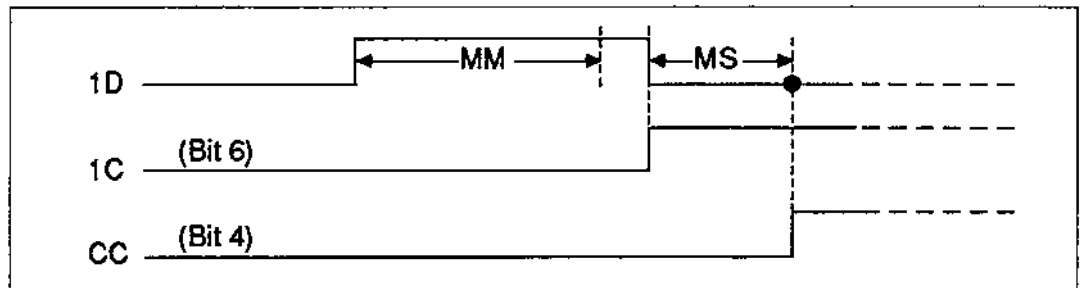

Figure 5.40 Reset After MM During ON Cycle

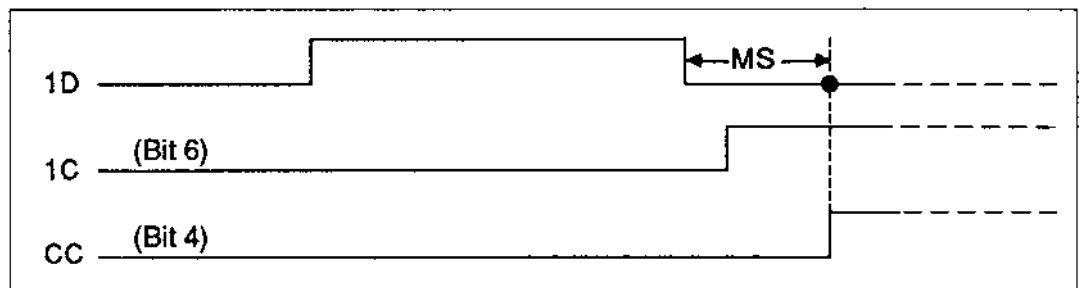

Figure 5.41 Reset During MS

Block Status — Digit D

Bit 3 of digit D automatically latches to logic 1 whenever the CPU detects a sumcheck failure in any of the parameters of the PGNT block. To clear this condition, re-enter any corrupted parameters, and then write a zero to bit 3.

1K & 2K Scaling Factors

1K and 2K are the multipliers of 1A ('mark' input) and 2A ('space' input) respectively. Their decimal point positions are set by bits in the block's ST parameter.

MM & MS Minimum 'Mark' & 'Space' Times

MM and MS define *minimum* pulse ON ('mark') and OFF ('space') times, respectively. The *actual* ON and OFF times of the pulse train output by the block depend on whether or not the 1A and 2A inputs are connected to, and if so, how their values compare with MM and MS. Table 5.32 shows this dependency. Note that the output can be held at zero, whatever the state of the reset input 1C, by connecting a signal to 1A such that $1K \times 1A$ is less than MM.





Scaled Mark $1K \times 1A$	Scaled Space $2K \times 2A$	Reset 1C	Output 1D
Unconnected	Unconnected	0	
Unconnected	$\geq MS$	0	
$\geq MM$	Unconnected	0	
$\geq MM$	$\geq MS$	0	
$< MM$	Don't Care	Don't Care	HELD LOW 
$\geq MM$ or Unconnected	$< MS$	Don't Care	HELD HIGH 

Table 5.32 PGNT Output Possibilities

NOTE. The ON and OFF times can never be less than the relevant loop repeat time, *even with zero values in MM, MS, 1K, and/or 2K.*

FC Function Control Register

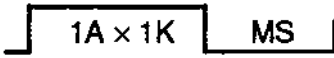
The FC parameter is explained on page 4.19. Please refer there for details.

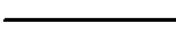
COUNT BLOCKS

PCNT : PULSE COUNTER

Block Function

The PCNT block counts the rising edges of a digital pulse input (1C), scales the count by 1K and outputs the result as an analogue pulse value (1B). When 1B reaches an End Pulse value (EP) the counter stops and a digital output flag (1D) is set. The counter can be zeroed via digital input 2C.

Block Connections

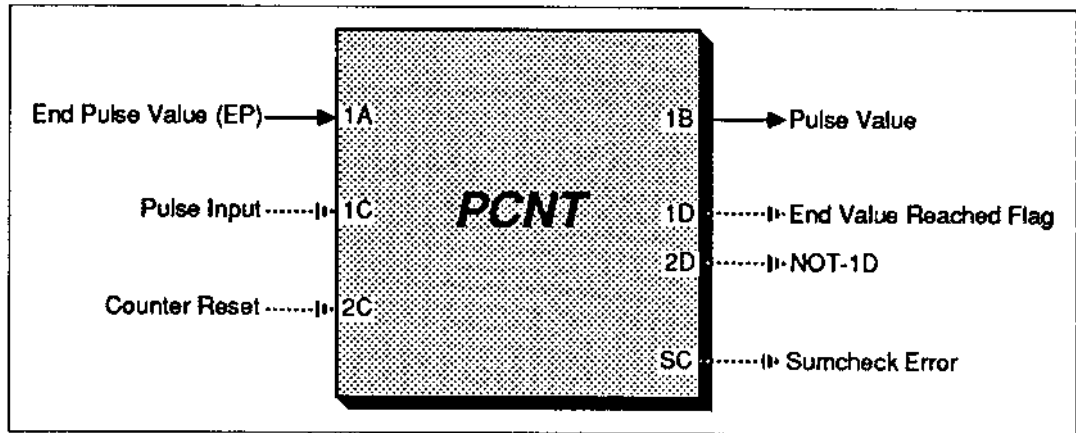

Figure 5.42 PCNT Block Connections

Figure 5.42 represents the PCNT block incoming and outgoing connections. The two-letter mnemonics in brackets are the parameters accessed by the connections.

NOTE. If left unconnected the parameters can be set via the HHT or RS422 data unit.

Incoming Connections. The connections coming into the PCNT block are summarised in Table 5.33.

Code	Connection	Function	Format*
1A	To EP parameter	End Pulse value	FP
1C		Pulse Input	0/1
2C	Counter Reset	Resets Pulse Value 1B to zero	0/1

Table 5.33 PCNT Incoming Connections

*See Table 4.2 for an explanation of these formats

Outgoing Connections. Table 5.34 summarises the outgoing connections from the PCNT block.

Code	Connection	Function	Format*
1B	Pulse Value	Scaled Pulse Count output	FP
1D	Count End Flag	Set when $1B \geq EP$	0/1
2D	NOT-1D	Set when $1B < EP$	0/1
SC	Sumcheck Error	Latches to 1 on sumcheck failure	0/1

Table 5.34 *PCNT Outgoing Connections*

Block Parameters

Table 5.35 lists the PCNT block parameters and the units or format in which they are expressed.

Mnemonic	Parameter	Format*
ST	Block Status	HHHH
1K	Scaling Factor for 1C Input	Eng.
EP	End Pulse Value	Eng.
FC	Function Control Register	HHHH

Table 5.35 *PCNT Block Parameters*

These parameters are covered in more detail in the sections that follow.

*See Table 4.2 for an explanation of these formats

ST Block Status

Figure 5.43 shows the meanings of the hexadecimal digits in the ST parameter of the Pulse Count block. (The symbols used in the parameter diagram are explained in Figure 4.2.)

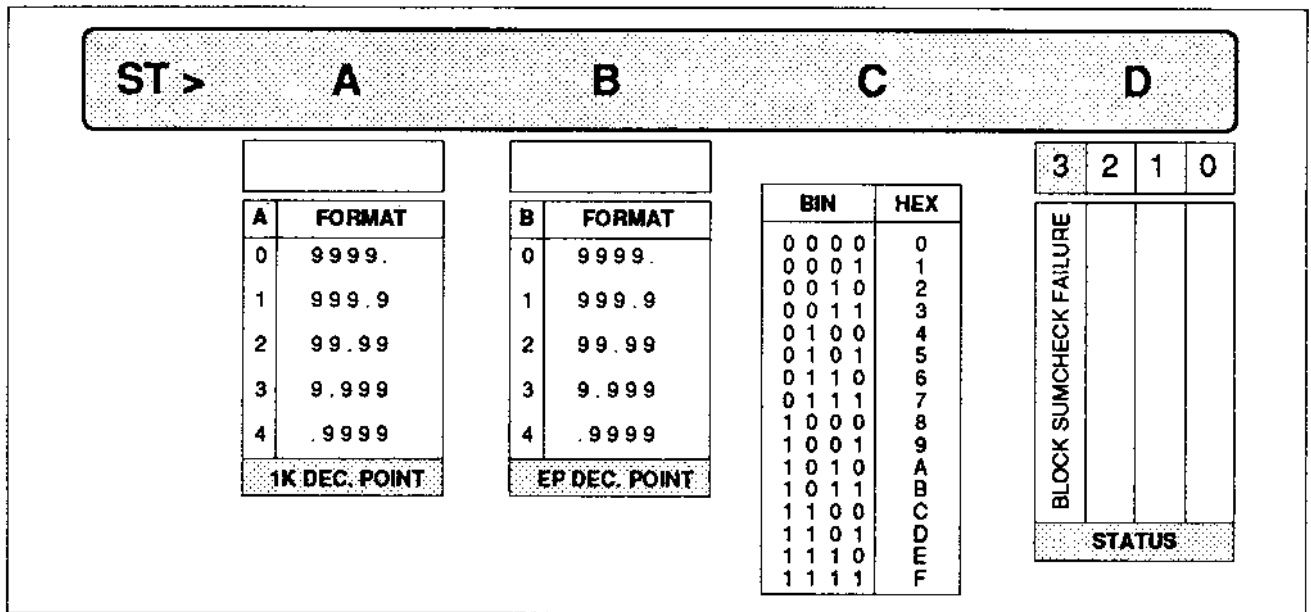

Figure 5.43 ST Parameter — Pulse Count Block

Decimal Point Selection — Digits A & B

A and B select the decimal point positions for the 1K scale factor and End Pulse Value (EP) parameters, respectively.

Block Status — Digit D

Bit 3 of digit D automatically latches to logic 1 whenever the CPU detects a sumcheck failure in any of the parameters of the PCNT block. To clear this condition, re-enter any corrupted parameters, and then write a zero to bit 3.

1K Scaling Factor

Provided the counter reset input 2C is not active, each time a digital rising edge appears at input 1C the Pulse Value parameter (1B) is increased by quantity 1K. 1K's decimal point position is set by digit A of the ST parameter.

EP End Pulse Value

When the pulse value calculated by the block reaches or exceeds the End Pulse Value EP, output 1B is made *equal* to EP. At the same time, the count-end flag (digital output 1D) sets to logic one. The 1B value actually *output* by the block is never allowed to exceed EP.

FC Function Control Register

The FC parameter is explained on page 4.19. Please refer there for details.

ASSIGNED BLOCKS

MAX/MIN BLOCKS

PEAK : PEAK DETECT (MAX/MIN)

Block Function

The PEAK block measures the maximum or minimum value of a varying analogue input and updates the block output with the result. An ST parameter bit sets maximum or minimum mode.

Block Connections

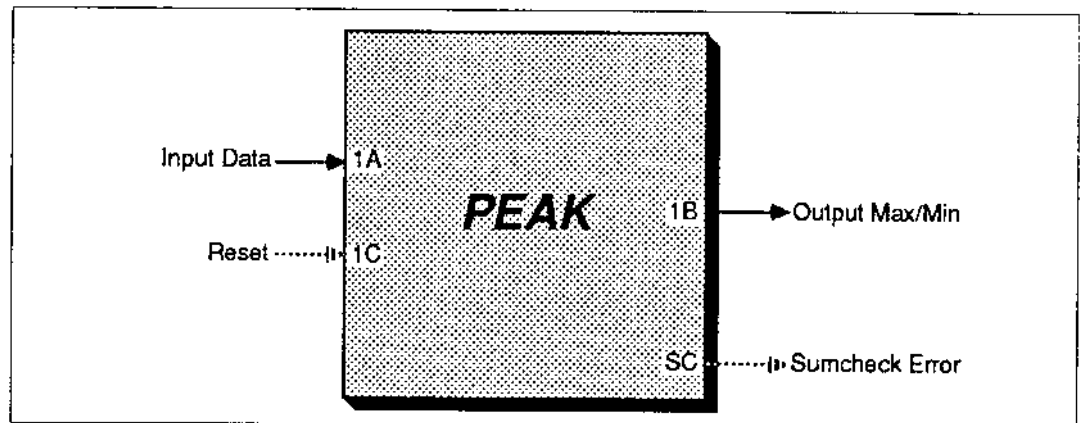

Figure 5.44 PEAK Block Connections

Figure 5.44 represents the PEAK block incoming and outgoing connections.

Incoming Connections. The connections coming into the PEAK block are summarised in Table 5.36.

Code	Connection	Function	Format*
1A	Input Data	Signal for Max/Min Detection	FP
1C	Reset	Makes 1B output = 1A input	0/1

Table 5.36 PEAK Incoming Connections

*See Table 4.2 for an explanation of these formats

Outgoing Connections. Table 5.37 summarises the outgoing connections from the PEAK block.

Code	Connection	Function	Format*
1B	Output data	Maximum or Minimum value	FP
SC	Sumcheck Error	Latches to 1 on sumcheck failure	0/1

Table 5.37 *PEAK Outgoing Connections*

Block Parameters

Table 5.38 lists the PEAK block parameters and the units or format in which they are expressed.

Mnemonic	Parameter	Format*
ST	Block Status	HHHH
FC	Function Control Register	HHHH

Table 5.38 *PEAK Block Parameters*

These parameters are covered in more detail in the sections that follow.

*See Table 4.2 for an explanation of these formats

ST Block Status

Figure 5.45 shows the meanings of the hexadecimal digits in the ST parameter of the Peak Detect (Max/Min) block. (The symbols used in the parameter diagram are explained in Figure 4.2.)

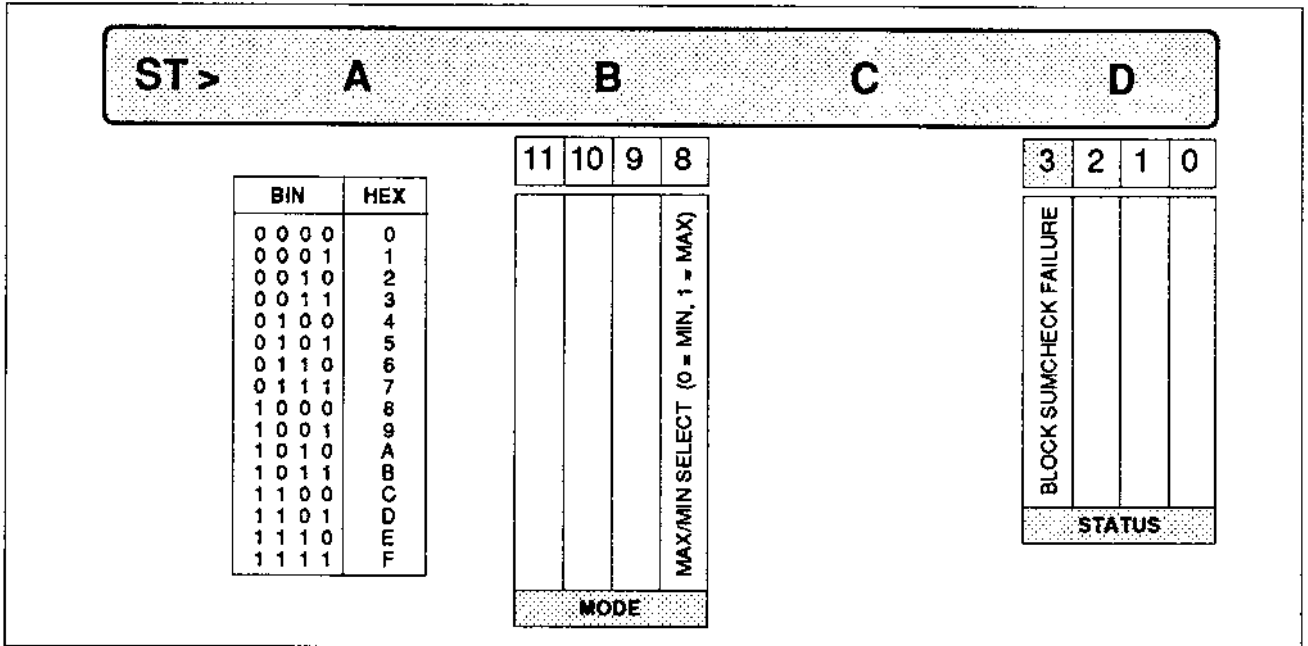

Figure 5.45 ST Parameter — Peak Detect (Max/Min) Block

Mode Select — Digit B

Set bit 8 to logic 1 to detect the maximum signal value, or to logic 0 to detect the minimum value.

Block Status — Digit D

Bit 3 of digit D automatically latches to logic 1 whenever the CPU detects a sumcheck failure in any of the parameters of the PEAK block. To clear this condition, re-enter any corrupted parameters, and then write a zero to bit 3.

FC Function Control Register

The FC parameter is explained on page 4.19. Please refer there for details.

PSEUDO I/O BLOCKS

AICB: SINGLE-CHANNEL PSEUDO ANALOGUE INPUT

AOCB: SINGLE-CHANNEL PSEUDO ANALOGUE OUTPUT

DICB: EIGHT-CHANNEL PSEUDO DIGITAL INPUT

DOCB: EIGHT-CHANNEL PSEUDO DIGITAL OUTPUT

Some supervisory computer systems are limited by not being able to communicate directly with Intelligent Loop Processors, although they can communicate with System 6000 6432 Signal Processors. Pseudo I/O blocks solve this problem by acting as '6432 I/O' accessible by both the limited supervisory system and the control strategy in the instrument.

Pseudo I/O Blocks Comms Addresses

Each pseudo I/O block in an Intelligent Loop Processor can be allocated an address (via digits C and D of its IN parameter), with a limit of eight different addresses per instrument. Each address can accommodate up to eight enabled and uniquely numbered channels, which must be of the same type (e.g. all AOCB), making a maximum of 64 pseudo channels of all types enabled per instrument. Because pseudo analogue blocks are single-channel but pseudo digital blocks are eight-channel, there can be up to *eight* analogue blocks enabled at any one address but only *one* digital block.

On the communications system a pseudo block appears as an instrument with decimal Instrument Number $INO_{dec} = (16 \times GID_{dec}) + UID_{dec}$. Note that pseudo I/O blocks appear only on the binary comms, not on the ASCII.

AICB: SINGLE-CHANNEL PSEUDO ANALOGUE INPUT BLOCK

Block Function

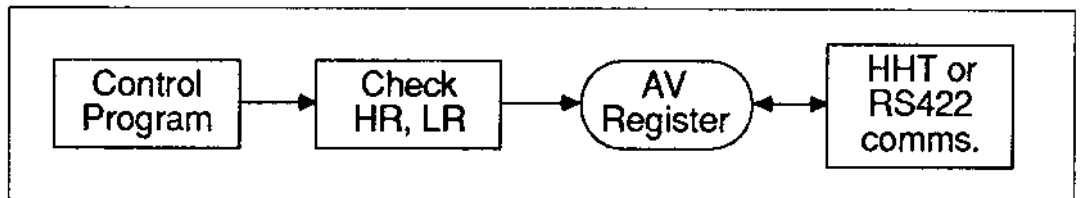

Figure 5.46 Pseudo Analogue Input Block Schematic

You can pass a ranged analogue value from your control program strategy into an AICB block (please refer to Figure 5.46). Here, the signal is checked against the HR and LR ranging parameters and stored in the AV parameter if it is within range; otherwise it is not allowed to update AV. AV is accessible by the supervisory computer system via its RS422 communications, and can also be read and updated via the Hand-Held Terminal.

Block Connections

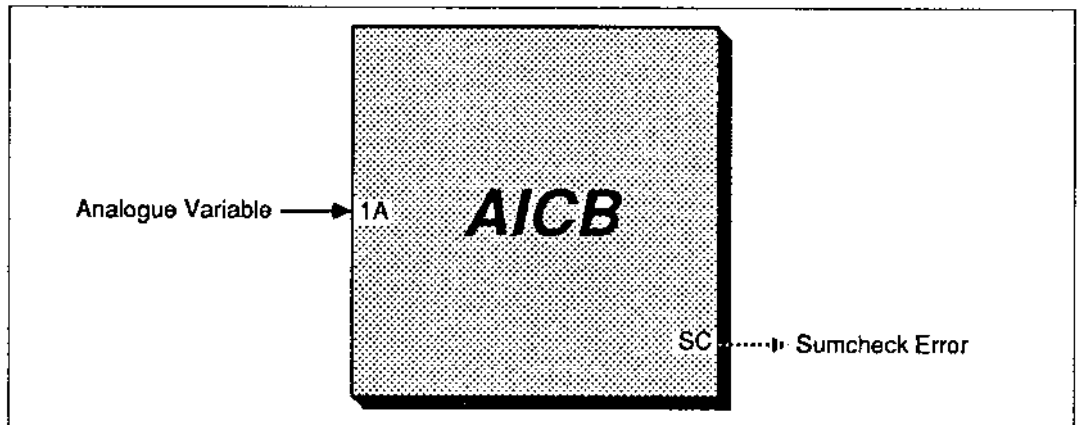

Figure 5.47 Pseudo Analogue Input Block Connections

Figure 5.47 represents the AICB block incoming and outgoing connections.

Incoming Connections. The (only) connection coming into the AICB block is summarised in Table 5.39.

Code	Connection	Function	Format*
1A	Analogue Variable	Scaled input value (from program)	FP

Table 5.39 AICB Incoming Connections

Outgoing Connections. Table 5.40 shows the (single) outgoing connection from the AICB block.

Code	Connection	Function	Format*
SC	Sumcheck Error	Latches to 1 on sumcheck failure	0/1

Table 5.40 *AICB Outgoing Connections*

Block Parameters

Table 5.41 lists the AICB parameters and the units or format in which they are expressed.

Mnemonic	Parameter	Format*
ST	Block Status	HHHH
IN	Block Identity	HHHH
HR	Analogue I/P High Range	±Eng.
LR	Analogue I/P Low Range	±Eng.
AV	Analogue Variable (scaled)	±Eng.
FC	Function Control Register	HHHH

Table 5.41 *AICB Block Parameters*

Each of these parameters is covered in more detail in the sections that follow.

ST Block Status

Figure 5.48 shows the meanings of the hexadecimal digits in the ST parameter of the Pseudo Analogue Input block. (The symbols used in the parameter diagram are explained in Figure 4.2.)

Decimal Point Selection — Digit A

Digit A selects the decimal point position for all the parameters in the AICB block that are in engineering units, i.e. HR, LR, and AV.

Status Bit — Digit D

Bit 3 of digit D automatically latches to logic 1 whenever the CPU detects a sumcheck failure in any of the parameters of the AICB block. To clear this condition, re-enter any corrupted parameters and then reset bit 3 to logic 0.

*See Table 4.2 for an explanation of these formats

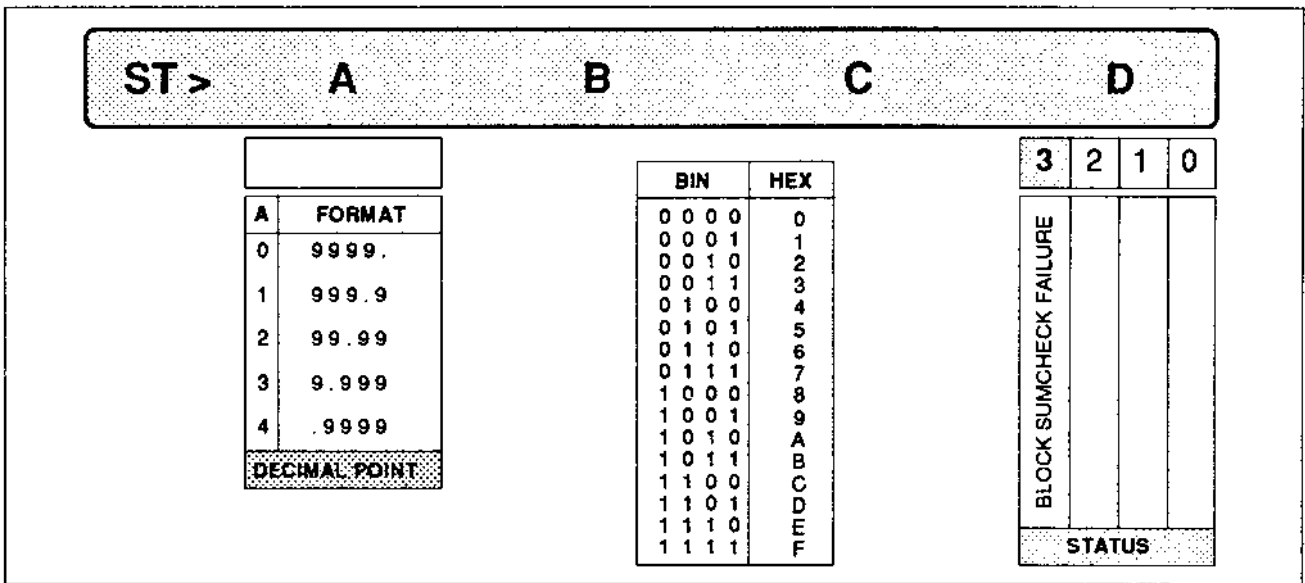

Figure 5.48 ST Parameter — Pseudo Analogue Input Block

IN Block Identity

Figure 5.49 shows the meanings of the hexadecimal digits in the IN parameter of the Single-Channel Pseudo Analogue Input block. (The symbols used in the parameter diagram are explained in Figure 4.2)

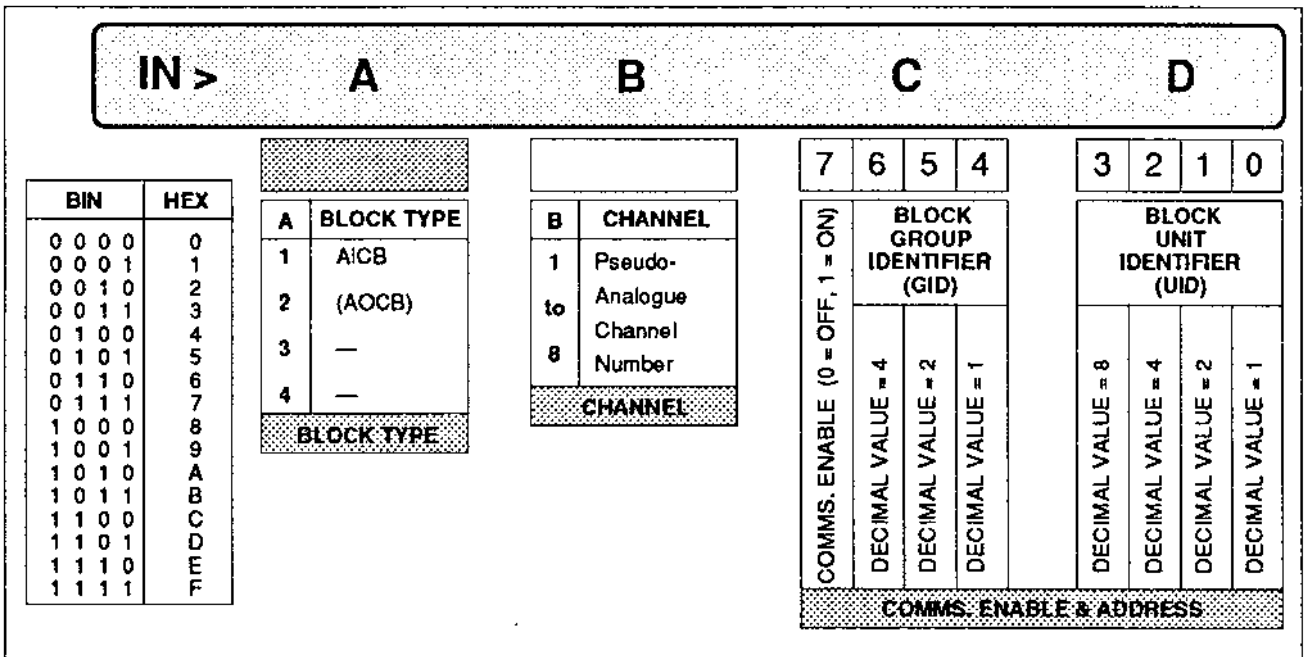

Figure 5.49 IN Parameter — Pseudo Analogue Input Block

Block Type — Digit A

Read-only digit A indicates the pseudo I/O block type: 1=AICB (2=AOCB, 3=DICB, 4=DOCB).

Channel Number — Digit B

Read/write digit B specifies the channel number allocated to the block, in the range 1 to 8.

Communications Enable & Address — Digits C & D

- **Comms Enable — Bit 7.** Set bit 7 to logic zero to suppress the block's response on the communications bus, or to logic 1 to enable (activate) communications. In the case of a sumcheck error occurring in the block, bit 7 automatically sets to zero ('off').
- **Block Group Identifier (GID) — Bits 6 to 4.** These three read/write bits set the block GID (from 0 to 7), which together with the block UID specifies the block Instrument Number (INO) on the comms.
- **Block Unit Identifier (UID) — Bits 3 to 0.** These read/write bits set the block UID (from 0 to 15).

Additionally, the decimal value of bits 1 and 0 determine the 6432 instrument block or 'slot number' that this pseudo block is emulating. Specifically:
Emulated 6432 Slot Number = $1 + (\text{bits } 1, 0)_{\text{dec}}$.

The decimal value of INO is calculated as $\text{INO}_{\text{dec}} = (16 \times \text{GID}_{\text{dec}}) + \text{UID}_{\text{dec}}$. Up to eight analogue channels, or eight digital channels, can be enabled at a single INO, and each Intelligent 6372/82 Loop Processor can have up to eight pseudo block INOs.

HR & LR Pseudo Analogue Input Ranging

HR (High Range) and LR (Low Range) define in engineering units the permitted span of the block's analogue variable input, AV. HR must exceed LR.

In the AICB block (unlike the ANIN block), HR and LR do not actually *range* the input signal, which is already in engineering units. Instead, they define the upper and lower limits of input signals that are allowed to update the AV parameter. Inputs outside this range are rejected by the block and do not alter AV.

AV Analogue Variable

The AV parameter holds the value of the ranged and checked (against HR, LR) analogue variable input signal, in engineering units. AV is accessible by the RS422 communications of a supervisory computer system, and also via the Hand-Held Terminal.

FC Function Control Register

The FC parameter is explained on page 4.19. Please refer there for details.

AOCB: SINGLE-CHANNEL PSEUDO ANALOGUE OUTPUT BLOCK

Block Function

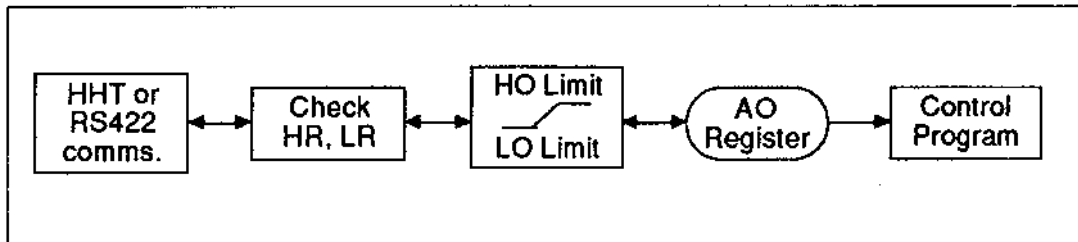

Figure 5.50 *Pseudo Analogue Output Block Schematic*

You can pass a ranged analogue value from a supervisory computer system (via its RS422 communications), or from the Hand-Held Terminal, into an AOCB block (please refer to Figure 5.50). Here, the signal is checked against the HR and LR ranging parameters. If it is within range it is stored in the AO parameter after limiting by HO and LO. If out of range it is not allowed to update AO. AO can pass values to your control program strategy, and can also be read by the HHT and comms.

Block Connections

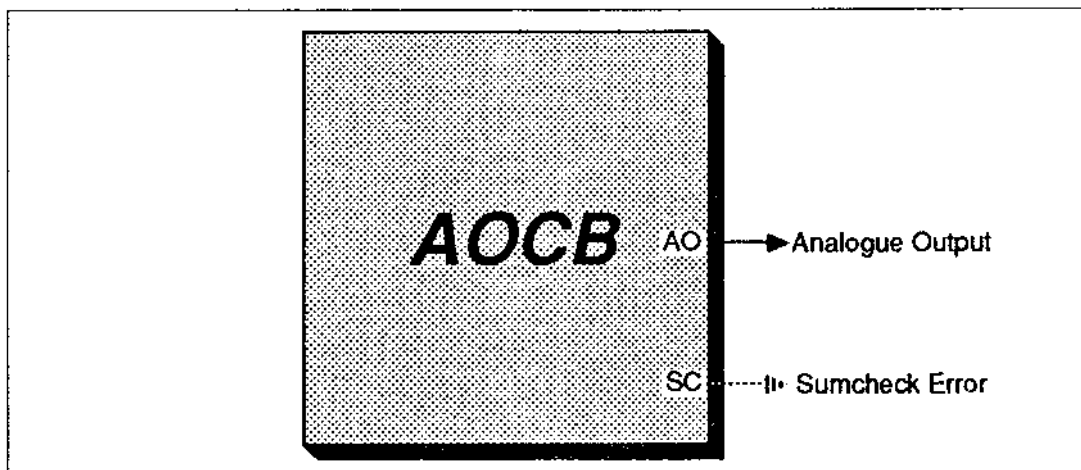

Figure 5.51 *Pseudo Analogue Output Block Connections*

Figure 5.51 represents the AOCB block outgoing connections.

Outgoing Connections. Table 5.42 shows the outgoing connections from the AOCB block.

Code	Connection	Function	Format*
AO	Analogue Output	Analogue Output value	FP
SC	Sumcheck Error	Latches to 1 on sumcheck failure	0/1

Table 5.42 AOCB Outgoing Connections

Block Parameters

Table 5.43 lists the AOCB parameters and the units or format in which they are expressed.

Mnemonic	Parameter	Format*
ST	Block Status	HHHH
IN	Block Identity	HHHH
HR	Analogue O/P High Range	±Eng.
LR	Analogue O/P Low Range	±Eng.
HO	High Output Limit	±Eng.
LO	Low Output Limit	±Eng.
AO	Analogue Output (scaled)	±Eng.
FC	Function Control Register	HHHH

Table 5.43 AOCB Block Parameters

Each of these parameters is covered in more detail in the sections that follow.

ST Block Status

The AOCB block's ST parameter exactly corresponds to that of the AICB block, described on page 5.64. Please refer there for details.

IN Block Identity

The AOCB block's IN parameter exactly corresponds to that of the AICB block, described on page 5.65. Please refer there for details.

*See Table 4.2 for an explanation of these formats

HR & LR Pseudo Analogue Output Ranging

HR (High Range) and LR (Low Range) define in engineering units the permitted span of the block's analogue output, AO. HR must be greater than LR.

In the AOCB block (unlike the ANOP block), HR and LR do not actually *de-range* the output signal, which remains in engineering units. Instead, they define the upper and lower limits of input signals that are allowed to update the AO parameter. Inputs outside this range are rejected by the block and do not alter AO.

NOTE. Changing HR and/or LR also changes the values of the HO and LO parameters. See the 'HO & LO' section for details.

HO & LO Analogue Output Limit

The HO (High Output Limit) and LO (Low Output Limit) parameters restrict the range (in engineering units) of AO. They operate on AO whatever its source: the Hand-Held Terminal or a serial data link. HO must be greater than LO. Also, HO cannot exceed HR, and LO cannot be less than LR.

HO and LO values are *automatically* altered by the instrument whenever you alter HR and LR. (The converse is not true: HO and LO do not affect HR and LR.) One aim of these automatic changes is to keep the HO-LO span at a constant ratio to the HR-LR span. The other is to keep the HO-LO span in the same relative position within the HR-LR span.

To achieve both these aims the instrument alters HO and LO to hold ratios $(HO-LO)/(HR-LR)$ and $(HR-HL)/(LO-LR)$ at constant values before and after HR, LR changes.

AO Analogue Output

The AO parameter holds the value of the checked (against HR, LR) and limited (by HO, LO) analogue output signal, in engineering units. AO can pass values to your control program and is accessible via the Hand-Held Terminal.

FC Function Control Register

The FC parameter is explained on page 4.19. Please refer there for details.

NOTE. Although the AOCB block has no input connections it must run in a specified User Task (1, 2, or 3) and therefore, exceptionally, has the FC parameter.

DICB: EIGHT-CHANNEL PSEUDO DIGITAL INPUT BLOCK

Block Function

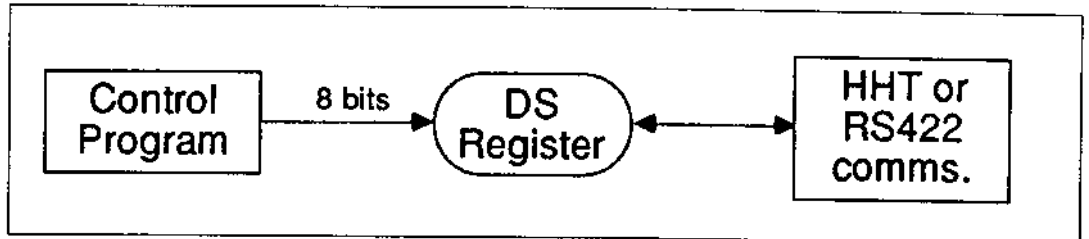

Figure 5.52 Pseudo Digital Input Block Schematic

You can pass digital signals from your control program strategy into an eight-way DICB block where they are held in the DS register (please refer to Figure 5.52). DS is accessible by the supervisory computer system via its RS422 communications, and can also be read and updated via the Hand-Held Terminal.

Block Connections

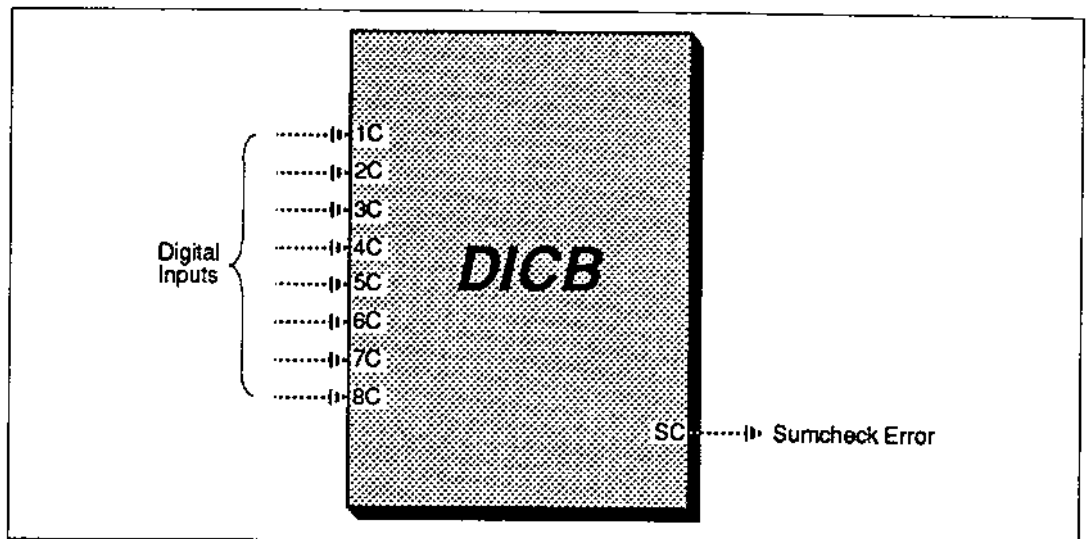

Figure 5.53 Pseudo Digital Input Block Connections

Figure 5.53 represents the DICB block incoming and outgoing connections.

Incoming Connections. The connections coming into the DICB block are summarised in Table 5.44.

Code	Connection	Function	Format*
1C to 8C	Digital Inputs	Inputs from control program	0/1

Table 5.44 *DICB Incoming Connections*

Outgoing Connections. Table 5.45 shows the (single) outgoing connection from the DICB block.

Code	Connection	Function	Format*
SC	Sumcheck Error	Latches to 1 on sumcheck failure	0/1

Table 5.45 *DICB Outgoing Connections*

Block Parameters

Table 5.46 lists the DICB parameters and the units or format in which they are expressed.

Mnemonic	Parameter	Format*
ST	Block Status	HHHH
IN	Block Identity	HHHH
WM	<i>(Dummy parameter only)</i>	HHHH
DS	Digital Input States	HHHH
FC	Function Control Register	HHHH

Table 5.46 *DICB Block Parameters*

Each of these parameters is covered in more detail in the sections that follow.

ST Block Status

The DICB block's ST parameter corresponds to that of the DGIN block, described on page 4.24. Please refer there for details.

IN Block Identity

Figure 5.54 shows the meanings of the hexadecimal digits in the IN parameter of the Eight-Channel Pseudo Digital Input block. (The symbols used in the parameter diagram are explained in Figure 4.2)

*See Table 4.2 for an explanation of these formats

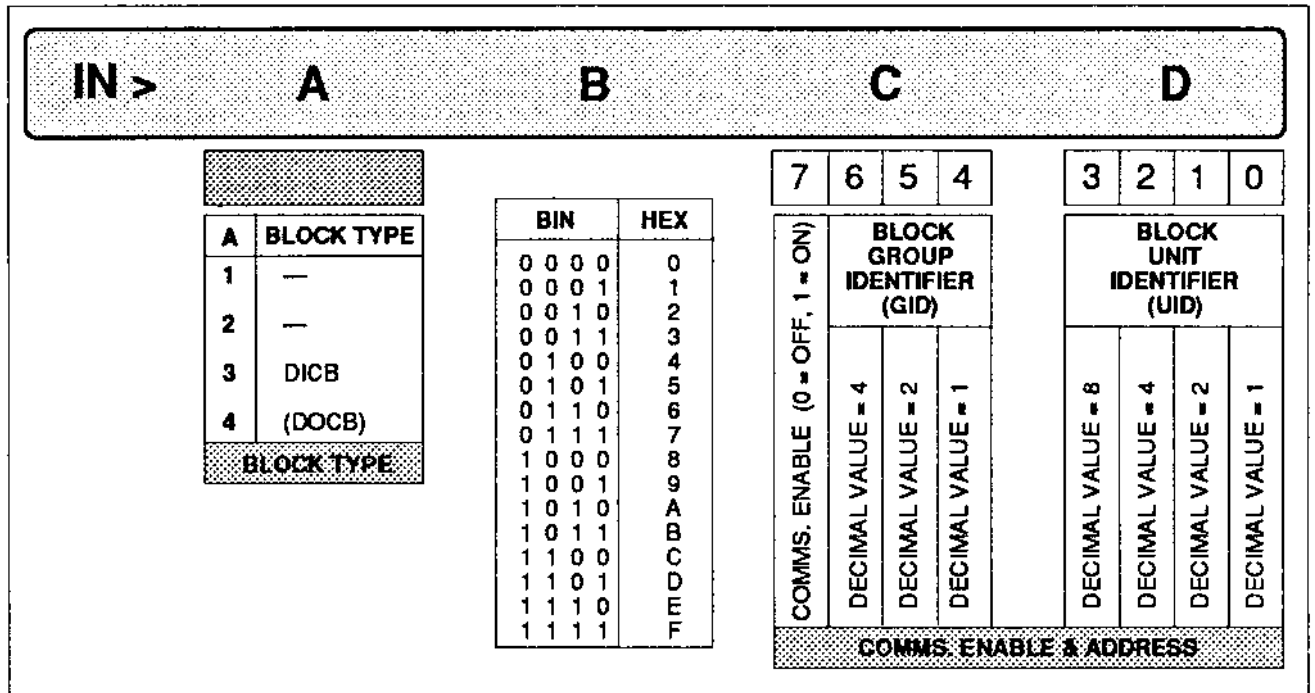

Figure 5.54 IN Parameter — Pseudo Digital Input Block

Digits A, C, and D correspond exactly to those of the AICB and AOCB blocks, already described on page 5.66. Digit B (*Channel Number* in pseudo analogue I/O blocks) has no meaning for the eight-channel pseudo digital blocks and is fixed at zero.

WM Write Mask

WM is a non-functioning *dummy parameter* in the DICB block, and has a 'don't care' value.

DS Digital Input States

Figure 5.55 shows the meanings of the hexadecimal digits in the DS parameter of the Pseudo Digital Input block. (The symbols used in the parameter diagram are explained in Figure 4.2.)

DS >																
A				B				C				D				
15	14	13	12	11	10	9	8	BIN		HEX						
DIGITAL INPUT 1 STATE	DIGITAL INPUT 2 STATE	DIGITAL INPUT 3 STATE	DIGITAL INPUT 4 STATE	DIGITAL INPUT 5 STATE	DIGITAL INPUT 6 STATE	DIGITAL INPUT 7 STATE	DIGITAL INPUT 8 STATE	0	0	0	0	0				
								0	0	0	1	1				
								0	0	1	0	2				
								0	0	1	1	3				
								0	1	0	0	4				
								0	1	0	1	5				
								0	1	1	0	6				
								0	1	1	1	7				
								1	0	0	0	8				
								1	0	0	1	9				
								1	0	1	0	A				
								1	0	1	1	B				
								1	1	0	0	C				
								1	1	0	1	D				
								1	1	1	0	E				
								1	1	1	1	F				
DIGITAL INPUT STATES																

Figure 5.55 DS Parameter — Pseudo Digital Input Block

Digits A and B indicate the logic states of the eight digital inputs of the DICB block. DS is read/write and you can alter logic states via the Hand-Held Terminal as well as via the RS422 communications link.

FC Function Control Register

The FC parameter is explained on page 4.19. Please refer there for details.

ASSIGNED BLOCKS

**DOCB:
EIGHT-CHANNEL PSEUDO DIGITAL OUTPUT BLOCK**

Block Function

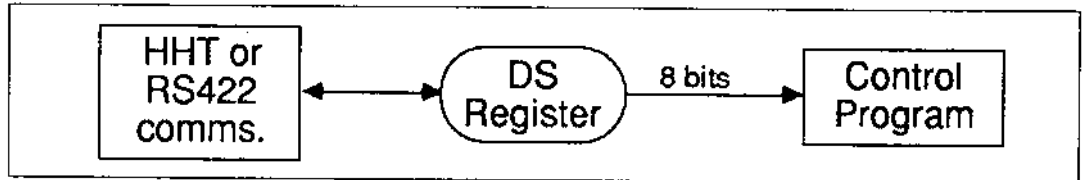

Figure 5.56 Pseudo Digital Output Block Schematic

You can pass digital signals from a supervisory computer system (via its RS422 communications), or from the Hand-held terminal, into an eight-way DOCB block where they are held in the DS register (please refer to Figure 5.56). DS is accessible by your control program strategy.

Block Connections

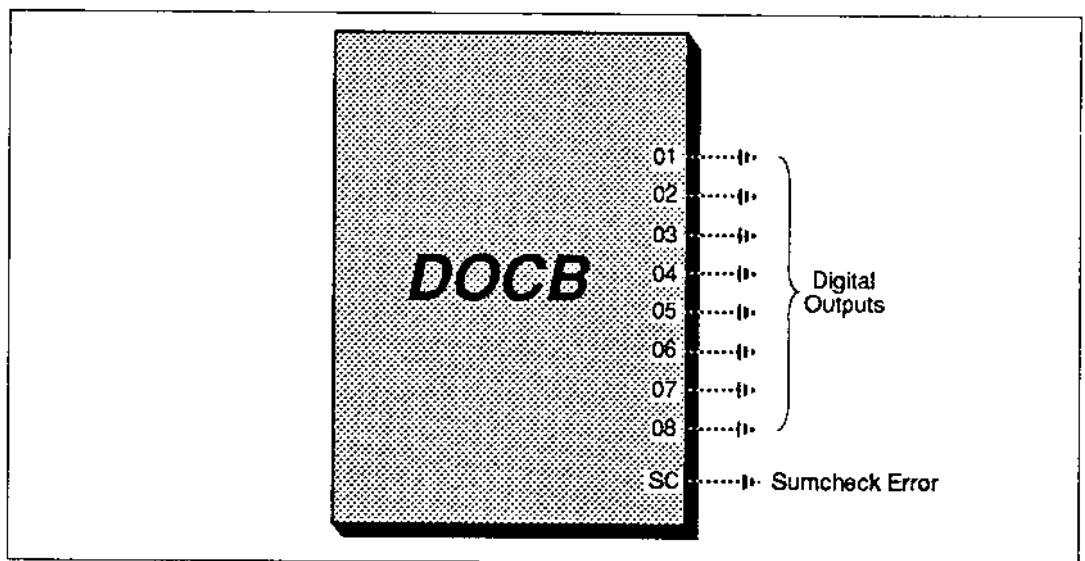

Figure 5.57 Pseudo Digital Output Block Connections

Figure 5.57 represents the DOCB block outgoing connections.

Outgoing Connections. Table 5.47 shows the outgoing connections from the DOCB block.

Code	Connection	Function	Format*
01 to 08	Digital Outputs	Outputs to control program	0/1
SC	Sumcheck Error	Latches to 1 on sumcheck failure	0/1

Table 5.47 DOCB Outgoing Connections

Block Parameters

Table 5.48 lists the DOCB parameters and the units or format in which they are expressed.

Mnemonic	Parameter	Format*
ST	Block Status	HHHH
IN	Block Identity	HHHH
XM	(Dummy parameter only)	HHHH
DS	Digital Output States	HHHH
FC	Function Control Register	HHHH

Table 5.48 DOCB Block Parameters

Each of these parameters is covered in more detail in the sections that follow.

ST Block Status

The DOCB block's ST parameter corresponds to that of the DGIN block, described on page 4.24. Please refer there for details.

IN Block Identity

The DOCB block's IN parameter corresponds to that of the DICB block, described on page 5.72. Please refer there for details.

XM Exclusive-OR Mask

XM is a non-functioning *dummy parameter* in the DOCB block, and has a 'don't care' value.

*See Table 4.2 for an explanation of these formats

DS Digital Output States

Figure 5.58 shows the meanings of the hexadecimal digits in the DS parameter of the Pseudo Digital Output block. (The symbols used in the parameter diagram are explained in Figure 4.2.)

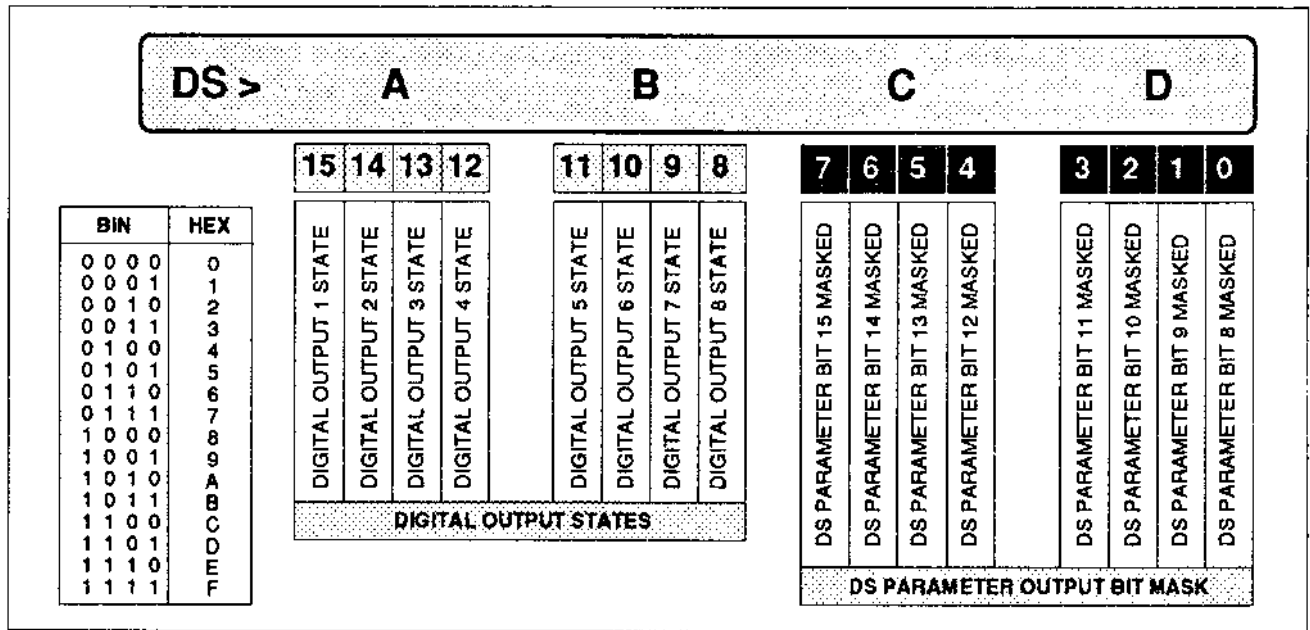

Figure 5.58 DS Parameter — Pseudo Digital Output Block

Digits A and B indicate the logic states of the eight digital outputs of the DOCB block. They are 'conditionally' read/write and you can alter logic states via the Hand-Held Terminal as well as via the RS422 communications link.

Digits C and D hold individual *mask bits* for each of the output bits in digits A and B. These write-only mask bits are used in the same way as those in the DGOP block's DS parameter, described on page 4.29.

NOTE. Although the mask bits and status bits of both pseudo (DOCB) and real (DGOP) digital output blocks have the same functionality, the allocation of bits to the four digits of the DS parameter is different.

FC Function Control Register

The FC parameter is explained on page 4.19. Please refer there for details.

NOTE. Although the DOCB block has no input connections it must run in a specified User Task (1, 2, or 3) and therefore, exceptionally, has the FC parameter.



Chapter 6

COMMAND MODE PARAMETERS

Command mode parameters let you check (or change) the instrument's identity, check (or change) the program identifier, review most of the motherboard switch settings, monitor the status of all front panel pushbuttons, identify blocks in sumcheck error, review the pseudo comms setup, test the front panel lamps, identify/store/recall EEPROM programs, and clear all control programs from the instrument. With 6372/82 instruments you can also check (or change) the displayed loop number.

The parameters are accessible via the ?? **CMD** prompt on the 8263 Hand-Held Terminal (or a VDU) plugged into the instrument's front panel RS232 socket. If you are new to the instrument you may find the section on 'Inspecting the Command Mode Parameters', in Chapter 2 of the User Guide, helpful.

Command Mode Parameters

Table 6.1 lists the command mode parameters and the units or format in which they are expressed.

Mnemonic	Parameter	Format*
II	Instrument Identity (read/write)	HHHH
ID	Instrument Identity (read-only)	HHHH
PI	Program Identifier	HHHH
SW	Motherboard Switch Settings	HHHH
PB	Front Panel Pushbutton Status	HHHH
SC	Fixed Block(s) Sumcheck Error	AB
P1 to P8†	Pseudo Comms. Setup	HHHH
LT	Lamp Test (front panel)	H
LN†	Loop Number (displayed)	1, 2, 3
E1	PI of EEPROM 1 Program	HHHH
E2	PI of EEPROM 2 Program	HHHH
FX	Store/Recall Database	S1-2, R1-2
CI	Clear Instrument	H

*See Table 4.2 for an explanation of these formats
†6372 & 6382 models only

Table 6.1 *Command Mode Parameters*

Each of these parameters is covered in more detail in the sections that follow.

II Instrument Identity (Read/Write)

II is the 'acting' instrument identity and is a read/write parameter. You can use II to make the instrument function totally like a different instrument, or merely *appear* to be a different instrument on the communications bus.

⚠ WARNING: Do not alter II whilst the instrument is controlling plant!

The first three digits of II tell you the acting instrument product code (omitting the leading '6'), and the last digit is the software issue number. So, for example, **II>3824** means a 6382 instrument with Issue 4 software.

Table 6.2 shows the possible values you can write to II for the range of Intelligent Loop Processors. Also listed are the resulting instrument functionality and appearance on the communications bus.

Instrument	ID	II Possibles†	Function	Comms.
6370	3704	3704	6370	6370
		3568	6370	1-loop 6356
		3508	6350*	6350
6380	3804	3804	6380	6380
		3668	6380	1-loop 6366
		3608	6360*	6360
6372	3724	3724	6372	6372
		3568	6372	6356**
		3508	6350*	6350
6382	3824	3824	6382	6382
		3668	6382	6366**
		3608	6360*	6360

*Power supply is isolated, unlike real 6350/60

**See Note 1 below

†See Note 2 below

Table 6.2 II Parameter & Instrument Functionality

COMMAND MODE PARAMETERS

NOTE 1. *6372/82 instruments only.* Set RS422 communications switches 5 and 6 of switchbank SW2. Please refer to Figure 1.5 on page 1.5 of the *User Guide*, or to the *Facts Book*, for details of switch positions. When II is set to 3568 or 3668, switch 6 is 'don't care' and switch 5 is OFF for single loop, ON for dual loop operation.

NOTE 2. Changing II may alter the baud rate and 'crash' the Hand-Held Terminal. If this happens, simply unplug then reconnect the terminal to allow it to reset its baud rate to the new value.

ID Instrument Identity (Read-Only)

ID indicates the *actual* model number and software issue of the instrument. It has the same format as II (see previous section), but is read-only.

PI Program Identifier

The read/write PI parameter is fully described in the section on the *General Purpose block* on page 4.91. Please refer there for details.

SW Motherboard Switch Settings

The read-only SW parameter indicates the settings of motherboard switchbanks SW1 and SW2. Figure 6.1 shows the meanings of the hexadecimal digits in the SW parameter. (The symbols used in the parameter diagram are explained in Figure 4.2.)

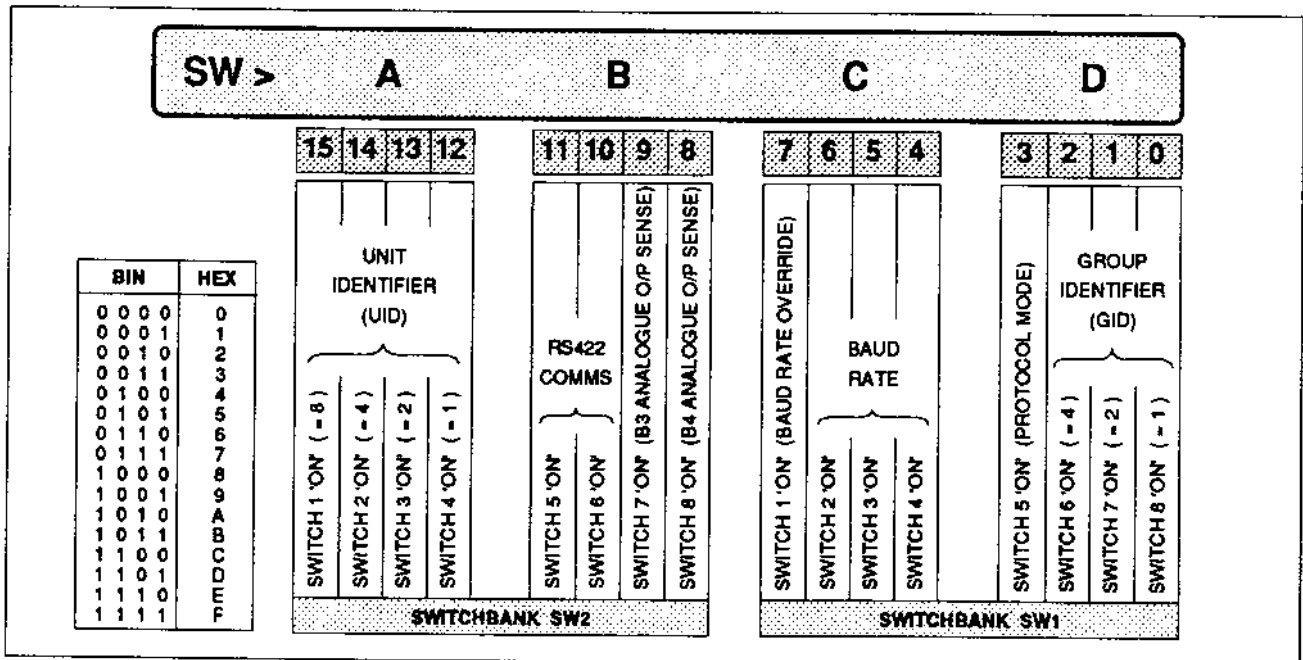

Figure 6.1 SW Parameter — Command Mode

The switches are illustrated and detailed in Chapter 1 of the *User Guide*, Figures 1.2 to 1.4.

PB Front Panel Pushbutton Status

Figure 6.2 shows the meanings of the hexadecimal digits in the Command Mode PB parameter. (The symbols used in the parameter diagram are explained in Figure 4.2.)

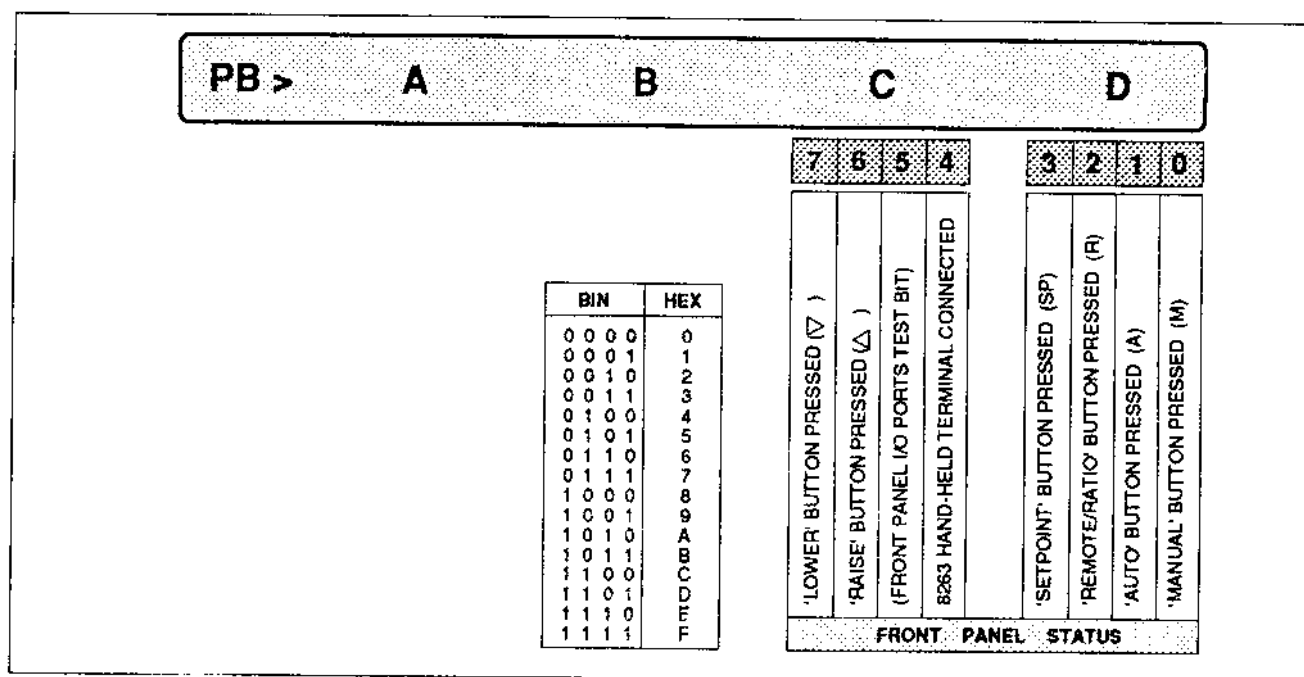

Figure 6.2 PB Parameter — Command Mode

Front Panel Status — Digits C & D

The PB parameter (digits C & D) lets you access the current state of the instrument's front panel controls, via the Hand-Held Terminal or supervisory data link.

- **Raise/Lower Buttons — Bits 6 & 7.** Normally at logic 0, these bits set to logic 1, respectively, whenever the RAISE (Δ) or LOWER (∇) pushbuttons are being pressed.
- **Test Bit — Bit 5.** Used as a test bit by the CPU to check out the functions of the front panel hardware input/output ports. Bit 5 can read as 0 or 1 and has no user significance.
- **Hand-Held Terminal Connected — Bit 4.** Sets to logic 1 whilst the 8263 Hand-Held Terminal is plugged into the front panel socket, and resets to logic 0 when it is removed.

COMMAND MODE PARAMETERS

NOTE. The supervisory computer and the Hand-Held Terminal cannot communicate with the instrument at the same time.

- **Manual, Auto, Remote/Ratio, and Setpoint Buttons — Bits 0 to 3.**
Normally at logic 0, these bits set to logic 1, respectively, whenever the MANUAL (M), AUTO (A), REMOTE/RATIO (R), or SETPOINT (SP) pushbuttons are being pressed.

SC Fixed Block(s) in Sumcheck Error

The read-only SC parameter holds the two-character address of any *fixed* block containing a sumcheck error. Exceptions are the Manual Station and Control blocks, which are flagged by the ??BCL mode prompt along with *assigned* blocks (see page 3.19).

If more than one fixed block is in error, SC 'stacks' the addresses and displays them singly one after another as you clear the errors in each sumcheck failed block.

P1 to P8 Pseudo Comms Setup

The read-only P1 to P8 parameters are fully described in the section on the *General Purpose block* on page 4.91. Please refer there for details.

LT Lamp Test

Writing any non-zero hexadecimal digit (1 to F) to the LT parameter simultaneously lights up every LED on the instrument's front panel for about 2 seconds, as a test. After the lamp test the value of LT resets to zero.

LN Loop Number

LN is a read/write parameter holding the number of the loop whose data is currently being displayed on the instrument front panel. For the 6370/80 single-loop instruments LN is omitted from the parameter list. Other models in the series can display loop 1, loop 2, and also 'loop 3' data. 'Loop 3' is the *display mode* which is described in Chapter 4, page 4.109, in connection with the DISP block. It does not refer here to a *control loop* or to the *User Task 3* background program.

NOTE. When the Loop Select (LN) input to the GENP block is unconnected you can normally alter the Loop Number parameter from the front panel (using the 'raise/lower' buttons) or via the Hand-Held Terminal or RS422 data link. But when LN is connected to a suitable (non-zero) signal, the parameter is *read-only*. Sometimes, however, when LN has been connected and afterwards disconnected, you may find you still cannot alter the loop number from the front panel. In this case use the HHT or RS422 link to alter LN and clear this condition.

E1, E2 EEPROM Stored Program Identifiers

The read-only E1 and E2 parameters hold the Program Identifiers (PI parameters) of the two control programs stored in EEPROM areas 1 and 2, respectively.

FX Store/Recall Database

FX lets you store up to two complete configuration databases to, or recall them from, the EEPROM area in the instrument. The stored databases, which include parameter values and block interconnections, can remain almost indefinitely in the instrument's memory independently of any power source.

Storing a Configuration

To store the entire configuration database currently in the RAM area of the instrument:

- Access the command mode prompt ?? **CMD**
- Key in FX, followed by Sn, where 'n' is 1 or 2 denoting the area of EEPROM where the database is to be stored.
- Press L to load the parameter value.

The message **Wait** appears. Then, after a few moments, the display on the Hand-Held Terminal (or VDU) screen changes to **FX OK**, showing that the database has been successfully copied to EEPROM.

COMMAND MODE PARAMETERS

The message **FX ER** means that storage has failed, either because of a faulty EEPROM or other instrument fault, or because the EEPROM is write-protected. The write-protect switch is switch 4 of motherboard switchbank SW3. This should be ON to enable read/write. (Figure 8.2 shows the switch details.)

⚠ WARNING: The RAM area of the instrument is not affected by the storage process, but the program pauses during the store operation, then continues.

Recalling a Configuration

This can only be done if PROGRAM write-protect is inactive, i.e. switch 3 of switchbank SW3 is ON (read/write).

To recall a configuration database from one of the two EEPROM areas to the RAM area of the instrument:

- Access the command mode prompt **?? CMD**
- Key in **FX**, followed by **Rn**, where 'n' is 1 or 2 denoting the area of EEPROM from which the database is to be recalled.
- Press **L** to load the parameter value.

The message **Wait** appears. Then, after a few moments, the display on the Hand-Held Terminal (or VDU) screen changes to **FX OK**, showing that the database has been successfully copied from EEPROM. The instrument front panel display blinks as the recalled database overwrites the RAM area, and the new program starts to run (if possible).

NOTE. The instrument power fail bit in the ST parameter of the General Purpose block (GENP) latches to logic 1 when a database is recalled to RAM. You may want to reset this bit; refer to Figure 4.37 on page 4.88 for ST parameter details.

CI Clear Instrument

CI is a write-only parameter used to trigger the *Instrument Cleanout* facility.

PROGRAM write-protect must be inactive, i.e. switch 3 of switchbank SW3 is ON (read/write).

- Type and load any non-zero hex digit to CI to display the message:

```
Clear Instrument
Sure (Y/N)?
```

- Press Y(es) to execute the cleanout, or N(o) to abort it. In either case CI automatically resets to zero, and the ?? CMD prompt returns.

Instrument Cleanout deletes all assigned blocks and their connections, resets all fixed block parameters to their default values, and clears any fixed block sumcheck errors. Programs stored in EEPROM are not affected.

NOTE. Whenever a block is newly installed from the *assigned block library* it is automatically cleared of any sumcheck errors and its parameters set to default values.

Chapter 7

CONTROL LOOP OPERATING MODES

The control blocks in Intelligent Loop Processors can operate in one of several different *control modes*, each having its own way of controlling the loop. The modes are listed in Table 7.1 together with their *priorities*.

Control Mode	Priority
HOLD	1 – highest
TRACK	2
FORCED MANUAL	3
MANUAL	4
AUTO (Local Setpoint)	5
REMOTE AUTO or RATIO	6
AUTO FALL-BACK	7 – lowest

Table 7.1 *Control Modes & Priorities*

Figure 7.1 represents the operating modes as a series of ‘switches’, and gives several types of information:

- **Mode Priority.** The nearer a ‘mode switch’ is to the MO (output) register the higher is its priority. E.g. when the TRACK mode (priority 2) switch is ‘on’ (*down*) the settings of all switches to its left have no effect on the control mode, which is TRACK. Only the HOLD mode (priority 1) switch can override TRACK.

If more than one mode is ‘switched on’ (enabled), only the mode with the highest priority will actually be operative in the loop. If the loop then exits its present mode, the enabled mode with the next highest priority takes over.

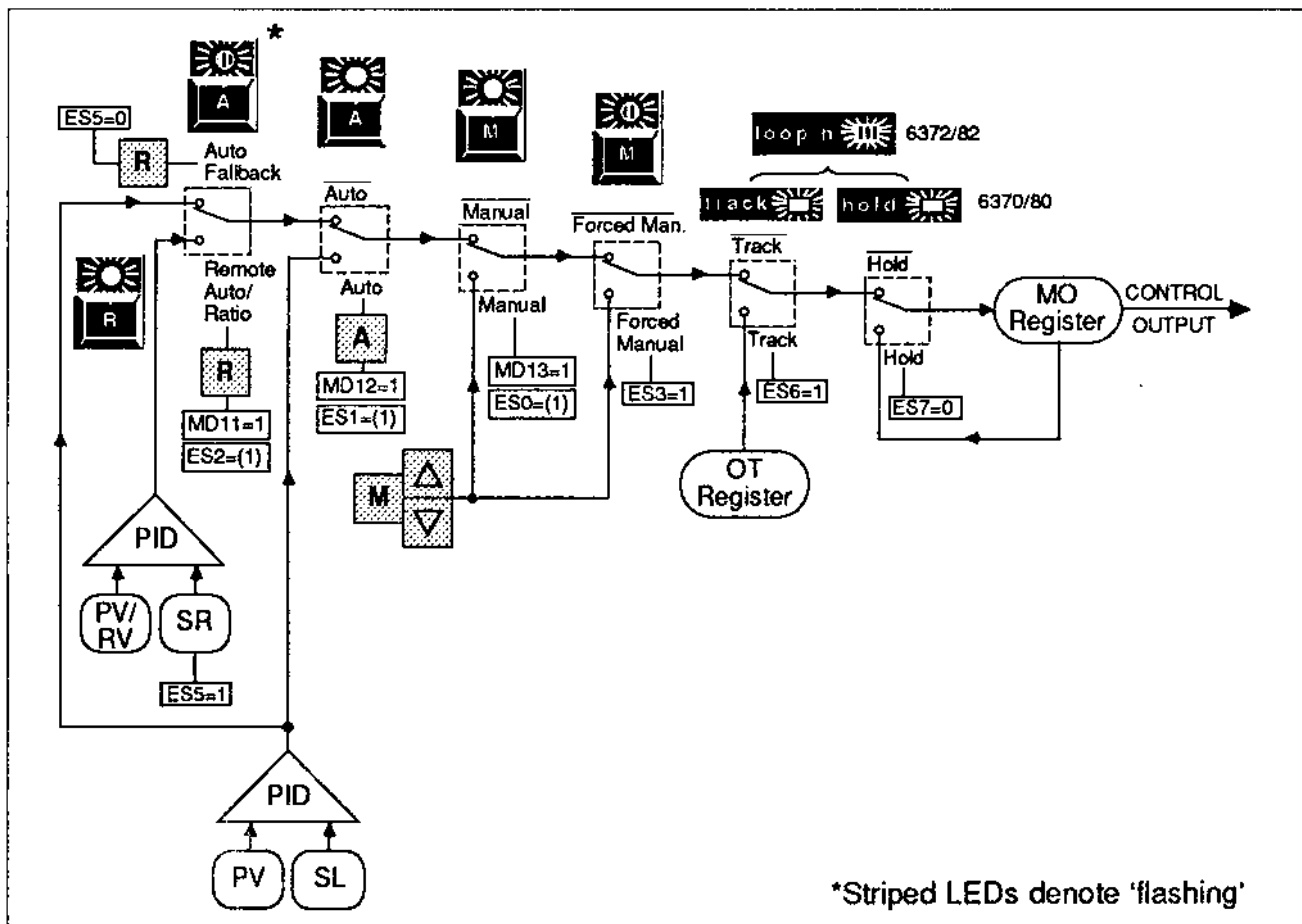

Figure 7.1 Control Loop Operating Modes

- Control Output Source.** This is shown for each mode as a (schematic) signal path to the MO register. E.g. in MANUAL mode MO can be varied via the 'M' and 'raise/lower' front panel pushbuttons. In AUTO mode MO derives from a PID calculation using PV and SL, the local setpoint.
- Mode Entry Conditions.** Which modes are enabled is determined by a set of *enabling conditions*. Some of these are shown below each of the 'mode switches'.

A complete list is given in Table 7.2.

E.g. AUTO mode can be enabled by pressing the front panel 'A' button, or by writing a logic 1 to bit 12 of control block parameter MD, or a logic 1 to ES parameter bit 1.

CONTROL LOOP OPERATING MODES

- **Front Panel Mode Indication.** The upper part of Figure 7.1 shows how each operating mode is indicated by LEDs on the instrument's front panel. (Note that TRACK and HOLD are indicated differently in different models of the instrument series.) In the figure, 'flashing' LEDs are shown as horizontally striped; steadily lit LEDs are white.

E.g. AUTO FALLBACK mode is indicated by the green LED on the 'A' button flashing, whereas a steadily lit LED indicates AUTO mode.

NOTE. It is possible for *two* enabled modes to be indicated simultaneously on the front panel (TRACK or HOLD, together with any one of the others). Only the higher priority mode is actually active; the second mode indicated is the 'suppressed' mode, which takes over if the higher mode is disabled.

Mode Entry & Operating Characteristics

Table 7.2 lists the conditions required to enable each of the seven loop operating modes. These comprise digital input states to the control block, parameter bit states, and front panel pushbutton operations.

Also listed are the main operating characteristics of each mode, in terms of control block digital outputs, status LED indications, parameter bit states, local setpoint behaviour, and control block output.

Mode	Enable Conditions ^[1]	Operating Characteristics ^[2]
Hold	HE=0 ^[3] or ES7=0 ^[4]	HS, NR=1 ^[5] ; Hold LED 'on' (or loop LED flashing); ST10=0: SL steady (variable via 'raise/lower' buttons); ST10=1: SL tracks PV; PID and MANS O/Ps fixed
Track	TE=1 or ES6=1	NR=1; HS=0; Track LED 'on'; Hold LED 'off' (or loop LED flashing); ST10=0: SL steady (variable via 'raise/lower' buttons); ST10=1: SL tracks PV; PID and MANS O/Ps follows OT
Forced Manual	^[6] FM=1 or ES3=1	<i>As for MANUAL mode, except:</i> Manual 'M' button LED 'flashing'; cannot exit mode by pressing pushbuttons
Manual	Press 'M' button or MD13=1 ^[7] or MA=1 or ES0=(1) ^[8]	MS, NR=1; HS, AS=0; 'M' button LED 'on'; vary MANS O/P via 'raise/lower' buttons; ST10=0: SL steady (variable via 'raise/lower' buttons); ST10=1: SL tracks PV
Auto	Press 'A' button or MD12=1 or AU=1 or ES1=(1)	AS, NR=1; HS, MS=0; 'A' button LED 'on'; vary SL via 'raise/lower' buttons; PID O/P computed from PV, SL
Remote Auto /Ratio ^[9]	[Press 'R' button or MD11=1 RA=1 or ES2=(1)] & [RE=1 or ES5=1]	NR, HS, AS, MS=0; 'R' button LED 'on'; or SL follows SR; PID O/P computed from PV, SR
Auto Fall-back	[Press 'R' button or MD11=1 or RA=1 or ES2=(1)] & [RE=0 or ES5=0]	<i>As for AUTO mode, except:</i> AS=0. 'A' button LED 'flashing'; reverts to REMOTE AUTO when RE=1 or ES5=1(re-enables remote setpoint)

Table 7.2 Control Mode Enable Conditions & Operating Characteristics

NOTES TO TABLE 7.2 [1] These conditions only *enable* modes. The one actually *active* is the enabled mode with the highest priority.

[2] In all modes, the 3-term PID control algorithm continuously adjusts the integral term so that transfer from one mode to another is usually bumpless and procedureless. The exception is changing to TRACK mode, when the control output is forced to equal the OT parameter in a single step.

[3] In this column, two-letter mnemonics are control block digital inputs, held at logic 0 or 1.

CONTROL LOOP OPERATING MODES

- [4] Two-letter mnemonics followed by a digit are individual bits of control block parameters. E.g. ES7 is bit 7 of parameter ES. Digital inputs to the control block automatically update any corresponding ES parameter bits.
- [5] In this column, two-letter mnemonics are control block digital outputs, at logic 0 or 1.
- [6] Unlike MANUAL mode, FORCED MANUAL mode cannot be exited by pressing any front panel pushbuttons. The enabling conditions must first be cancelled.
- [7] Selecting the mode by pressing the front panel 'M', 'A', or 'R' pushbutton automatically sets bit 13, 12, or 11, respectively, of the MD parameter.
- [8] Brackets '(1)' denote a write-only bit, which always reads back as 0.
- [9] REMOTE AUTO mode applies only to XPID and XCON control blocks. RATIO mode applies only to RPID and RCON blocks.

NOTE. If the program has connections to any of the control block's HE, TE, RE, or FM digital inputs, you cannot write to the corresponding ES parameter bit(s), which become(s) read-only. This applies whatever the state of the digital inputs.

If the program has active (i.e. at logic 1) connections to any of the control block's MA, AU, or RA digital inputs, you cannot override them by writing to the ES or MD parameters or by pressing the front-panel pushbuttons. If none are high, ES, MD, and the pushbuttons act normally.

Table 7.3 shows the logic states of the control block mode status output digital for all possible combinations of modes.

The 'suppressed' mode is the one that takes over if the higher priority 'active' mode becomes disabled.

The 'Dup.' (duplication) column shows which combinations of output states are identical, and so could give rise to ambiguity.

Active Mode	Suppressed Mode	Control Block Output Status				
		HS	NR	AS	MS	Dup.
Auto Fall Back	—	0	1	0	0	A
Remote/Ratio	—	0	0	0	0	B
Auto	—	0	1	1	0	C
Manual	—	0	1	0	1	D
Forced Manual	—	0	1	0	1	D
Track	Auto Fall Back	0	1	0	0	A
	Remote/Ratio	0	1	0	0	A
	Auto	0	1	1	0	C
	Manual	0	1	0	1	D
	Forced Manual	0	1	0	1	D
Hold	Auto Fall Back	1	1	0	0	E
	Remote/Ratio	1	1	0	0	E
	Auto	1	1	1	0	F
	Manual	1	1	0	1	G
	Forced Manual	1	1	0	1	G
Track	Auto Fall Back	1	1	0	0	E
	Remote/Ratio	1	1	0	0	E
	Auto	1	1	1	0	F
	Manual	1	1	0	1	G
	Forced Manual	1	1	0	1	G
Bit No. in Control Block MD word		15	4	12	13	

Table 7.3 Mode Information from 6370/80 Series Control Blocks

Summary	HS	= 1 if in HOLD
	NR	= 0 if in Remote or Ratio
	AS	= 1 if Auto selected
	MS	= 1 if Manual (or Forced Manual) selected

Control Loop Example

Figure 7.2 shows an example of a simple control strategy (configured in loop 1) based on the XCON control block, which has a built-in manual station. The strategy is intended to operate in three modes, AUTO, MANUAL, and FORCED MANUAL.

AUTO Mode. The process variable signal enters the instrument via an analogue input (ANIN) block, from where the scaled (AV) signal passes to the control block's PV connection. In the XCON block PV is compared with the setpoint (held in the SP parameter) and a 3-term (PID) value calculated and output via the MO connection. The control output passes out of the instrument to the actuator via an analogue output (ANOP) block.

CONTROL LOOP OPERATING MODES

NOTE. The B4 ANOP block is used because with *default mode* selected, in the event of an error causing a program halt, the block output is automatically supplied by the manual station (MANS, M1) block resident in the instrument, allowing immediate manual intervention.

Additionally, in loop 2 of 6372/82 instruments, ANOP block B3 switches to MANS M2 on program halt (default mode selected).

MANUAL Mode. In MANUAL mode, you control the output to the process using the front-panel 'raise' and 'lower' pushbuttons. The control algorithm continuously adjusts the integral term of the PID calculation, and (with bit 10 of the ST parameter set to 1) the local setpoint SL tracks the process variable PV. A switch back to AUTO mode can therefore be completely bumpless.

FORCED MANUAL Mode. The ANIN block's digital outputs SC and OC (see Figure 7.2) connect to an OR2 block, whose true output 1D connects to the FM input of XCON. This means that if the PV signal is open-circuited, or if an ANIN sumcheck error occurs, the control block is locked into FORCED MANUAL mode operation, with front-panel manual control of the MO output. Until the errors are rectified, you cannot exit this mode via the front panel pushbuttons.

NOTE. In all modes, to prevent the loop being permanently in HOLD, the HE input of the XCON block must be held at logic 1, or a logic 1 written to bit 7 of the ES parameter.

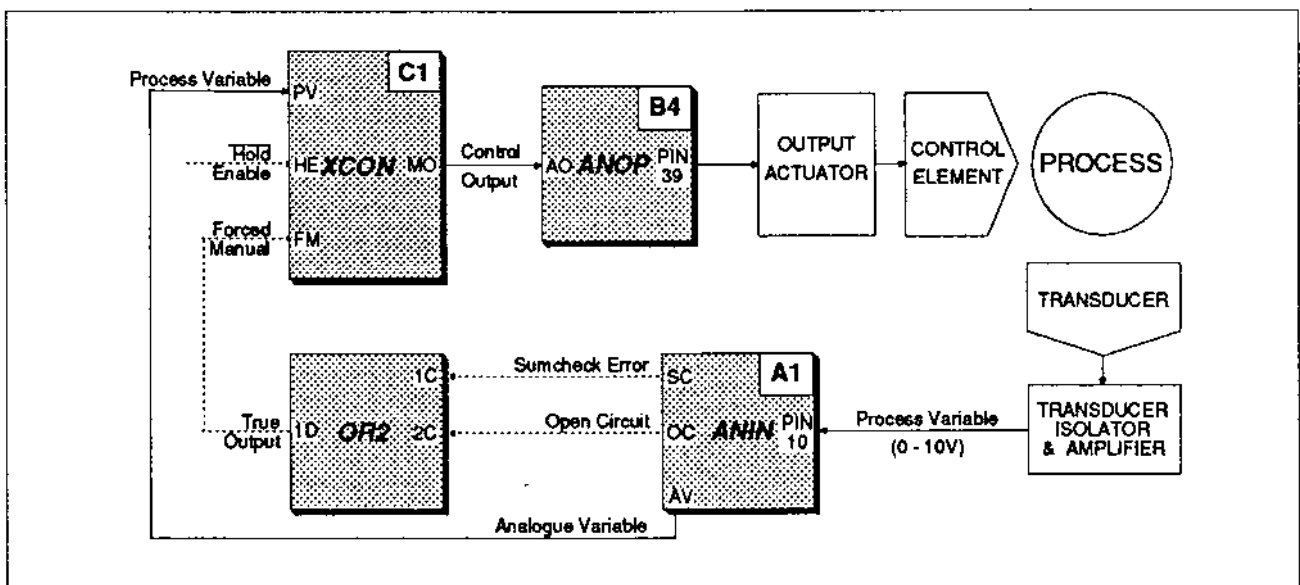

Figure 7.2 Example of AUTO/MANUAL Control Loop

Default Mode

Purpose

Allows use of fail-safe measures and manual intervention in case of program halt, when normal control strategy interconnections and safety measures may become ineffective.

Selection

Select default mode by setting switch 1 of Switchbank SW3 to ON. (OFF de-selects default mode.)

Action

With default mode selected, when a program halts:

- For a Loop 1 halt, the MO output of the Manual Station block MANS M1 automatically connects directly to Analogue Output block ANOP B4.
- For a Loop 2 halt, the MO output of the Manual Station block MANS M2 automatically connects directly to Analogue Output block ANOP B3.
- The relevant ANOP block High & Low Output Limit parameters (HL, LL) are disabled during the program halt.
- FORCED MANUAL control mode operation takes over for the halted loop.
- The DO08 field output of the Digital Output block DGOP (instrument pin 23) goes LOW (0V). With default mode selected it holds at HIGH (15V) only if *all* loop programs are running. A digital connection to DO08 ANDs with the default mode 'program running' flag. With default mode deselected the DO08 field output is not sensitive to program run status.

The default mode connections are independent of any control strategy connections. With default mode *deselected* these automatic connections are not made on program halt.

Bumpless Transfer. When the program first halts, MO is updated once from AO to make the transfer bumpless. Specifically, MO% is calculated from AO (engineering units) as:

$$MO = \frac{100(AO-LR)}{HR-LR}$$

CONTROL LOOP OPERATING MODES

Subsequently, during the program halt, AO is back-calculated from MO as:

$$AO = \frac{MO}{100}(HR-LR) + LR$$

so that return to program control is also bumpless.

The ANOP block's output to the field is held at the voltage equivalent of MO%. E.g. for 0 - 10V range, MO at 40%, the field output is 4V.

Note that the MANS block rate and output limits remain active during program halt.

Uses of Default Mode

The DGOP DO08 field output can be hard-wired to external monitoring equipment or interacting controllers to trigger appropriate action if any program halts.

By connecting the Loop 1 control output via Analogue Output block B4, immediate manual intervention is possible on program halt because the output will be automatically driven by the resident MANS M1 block. The same applies to MANS M2 if the Loop 2 control output is connected via ANOP B3.

NOTE. If the *default mode* of controller operation has been disabled (switch 1 of switchbank 3 set to OFF) the ANOP output sense in use should be input to the control block via its OS digital input connection. This sets bit 4 of the ES parameter.

If default mode has been enabled (switch 1 of switchbank 3 set to ON), then the ANOP output sense referred to by the control block at shutdown is the one for the default ANOP; i.e. B4 for M1, and B3 for M2. In this case you should leave input OS unconnected.

6370/80 Series 3-Term Control Algorithm

Analogue 3-Term Control Equation. The classical 3-term (PID) control equation, implemented by conventional analogue controllers using operational amplifiers, is usually written as:

$$OP = -\frac{100}{XP} \left[ER + \frac{1}{TI} \int ER dt + TD \frac{dER}{dt} \right] \quad (1)$$

where: OP = controller output
 XP = proportional band
 TI = integral time constant
 TD = derivative time constant
 ER = error (PV-SP).

This equation may be rewritten in the Y(s) terminology of the Laplace transformation:

$$\frac{OP(s)}{ER} = -\frac{100}{XP} \left(1 + \frac{1}{sTI} + sTD \right) \quad (2)$$

Limiting of the high frequency response introduces a digital limit filter, typically chosen to have a time constant equal to a quarter of the derivative time. The complete transfer function is then:

$$\frac{OP(s)}{ER} = -\frac{100}{XP} \left(1 + \frac{1}{sTI} + sTD \right) \left(\frac{1}{1 + sTD/4} \right) \quad (3)$$

Digital Control Algorithm. In microprocessor-based instruments like the 6370/80 Series Intelligent Loop Processors, sampling techniques must be used to calculate the terms of the control equation. It is also more convenient to rewrite the transfer function in terms of difference equations rather than the Y(s) Laplace transform terminology. Thus the 3-term calculated output after n samples is given by:

$$OP_n = -\frac{100}{XP} \left[ER_n + \frac{TS}{TI} \sum_{r=1}^{r=n} ER_r + \frac{TD}{TS} \Delta PV_n \right] + FF \quad (4)$$

where (additionally):

FF = feed-forward term
 OP_n = controller output after n samples
 ER_n = value of error at sample n
 ER_r = value of error at sample r
 ΔPV_n = change in filtered process variable value between samples n and n-1

CONTROL LOOP OPERATING MODES

ΔPV_n is obtained after first-order filtering with an effective time constant $TD/4$, thus:

$$\Delta PV_n = \Delta PV_{n-1} + \frac{4TS}{TD} (dN - \Delta PV_{n-1}) \quad (5)$$

where (additionally):

$$dN = PV_n - PV_{n-1}$$

The process variable PV is itself a filtered version of a sampled analogue input value, MV :

$$PV_n = PV_{n-1} + \frac{TF}{IF} (MV_n - PV_{n-1}) \quad (6)$$

where (additionally):

MV_n = value of analogue input at sample n
 TF = effective first-order time constant
 IF = input channel filter constant.

NOTE. The FF offset is apparent at zero error under proportional-only control action with the integral term disabled. This allows the output to respond to both positive and negative errors, if required.

Equivalence Between Analogue & Digital Equations.

When the setpoint is constant, the digital algorithm of equation (4) may be written as the following equivalent continuous transfer function:

$$\frac{OP(s)}{ER} = - \frac{100}{XP} \left(1 + \frac{1}{sTI} + sTD \right) \left(\frac{1}{1 + sTD/4} \right) \quad (7)$$

This can now be compared with the classical $Y(s)$ version of the analogue controller shown in equation (2). The proportional (P) and integral (I) terms are identical, but the derivative (D) term is slightly modified. This is because the additional first-order filtering is applied to the derivative value ΔPV , rather than to the error directly.

NOTE. The response to local setpoint (SL) changes is determined by the value of bit 11 of the control block's ST parameter, which can be set to disable integral term balancing on SL changes.

Integral balance is *automatically* done whenever the loop mode is changed to Auto, Auto Fall-back, or Remote Auto, or whenever the XP value is changed.

For further description of the 3-term algorithm refer to Section 3 of TCS publication *System 6000 Controller Applications Handbook*.

Integral Balance & Integral Desaturation

These are two calculating techniques, triggered by specific conditions, applied to the *integral term* of the PID algorithm to improve controller output behaviour when these conditions arise. Although the techniques are generally beneficial in a control loop, they do distinctively modify its response characteristics — a point that must be considered when designing and tuning a control system.

Integral Balance

Integral balance is applied to prevent abrupt changes — ‘bumps’ — in the output which might otherwise occur after control mode changes, and step changes in certain control parameters (e.g. setpoint). Output bumps are undesirable because they can damage valves and destabilise the process.

In essence, integral balance works by adjusting the integral accumulator ($TS/TI \cdot \Sigma ER_i$) in the PID calculation to keep the new output (almost) equal to the value it had before the triggering event. Mathematical details are given in a later section.

Effect of Integral Balance on Dynamics. Figures 7.3 and 7.4 show as an example the output (OP) and process variable (PV) responses to an abrupt setpoint (SP) change, without and with integral balance being applied, respectively. In this case applying integral balance markedly reduces the slope and peak value of the OP response, whilst at the same time bringing PV to the new SP just as rapidly but with half the overshoot.

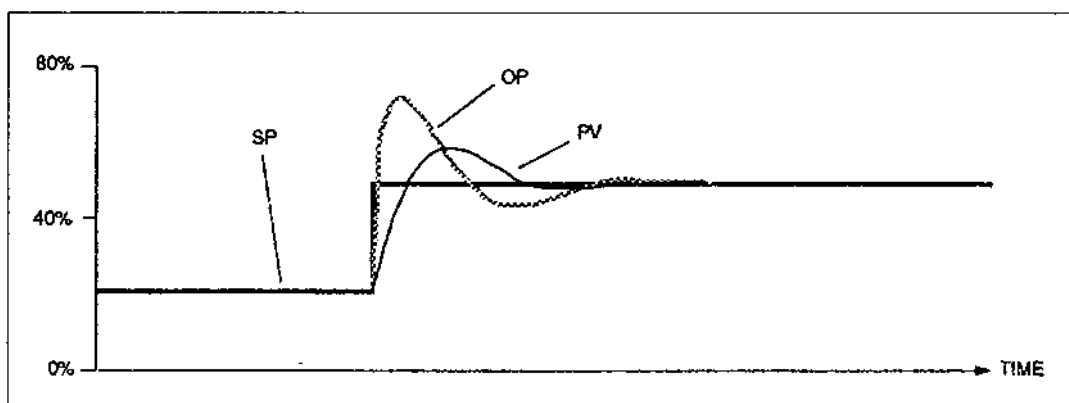

Figure 7.3 Response to Step Setpoint Change — Without Integral Balance

CONTROL LOOP OPERATING MODES

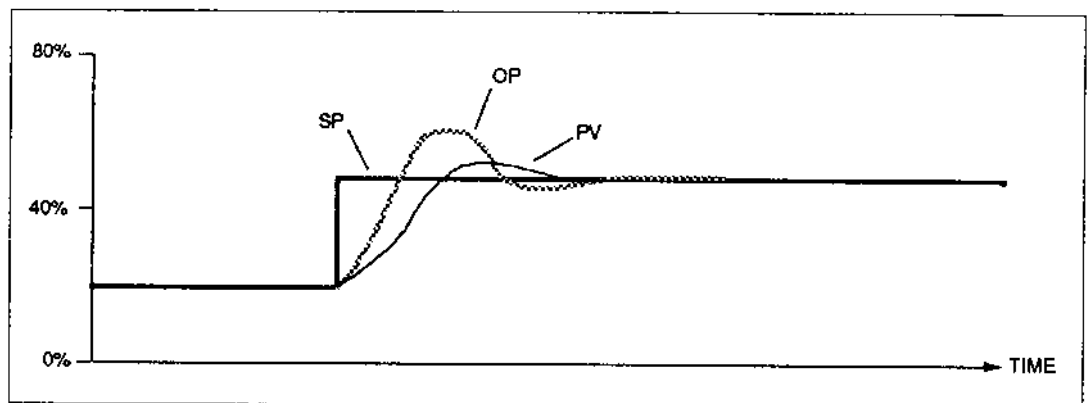

Figure 7.4 Response to Step Setpoint Change — With Integral Balance

Clearly, integral balance modifies the loop's response to setpoint changes, and this must be considered when a loop is being tuned using these changes. The response of a well-tuned loop with integral balance generally has less overshoot than one without.

Conditions Triggering Integral Balance Application

- Changing the local setpoint (SL) in AUTO mode. (Optional, via the control block's ST parameter).
- Changing the proportional band (XP) in AUTO or REMOTE.
- Changing operating mode to any automatic mode (AUTO, REMOTE, AUTO FALLBACK).
- Setting the control block's IB (Perform Integral Balance) input, or 3T parameter bit 6, to high.

Integral Balance & Adaptive Gain Control. Integral balance is particularly useful in plants where several sets of tuning constants are needed to cope with different process dynamics at different operating bands (e.g. pH titrations). Here, integral balance prevents bumps in the output each time the constants are changed at a boundary.

In some control applications the value of the proportional band XP must be varied *continuously* ('adaptive gain') resulting in an integral balance being performed at every iteration of the PID algorithm. This is not a problem because the output after a balance is never made *exactly* equal to the previous output, and so control can still be exercised. But because the output changes at each iteration by only a small increment, a controller using both adaptive gain and integral balance has a distinctive 'non-traditional' response. Figures 7.5 and 7.6 illustrate these differences for a non-linear process with XP varying as a

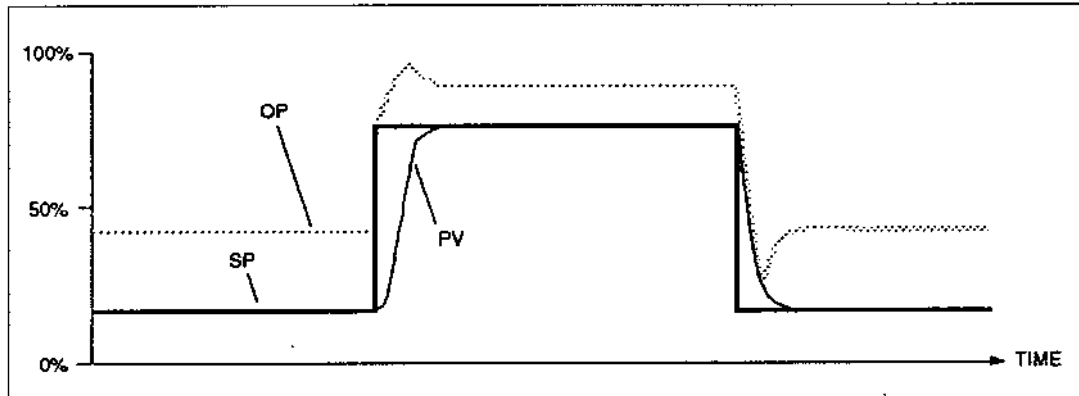

Figure 7.5 Adaptive Gain Responses — Without Integral Balance

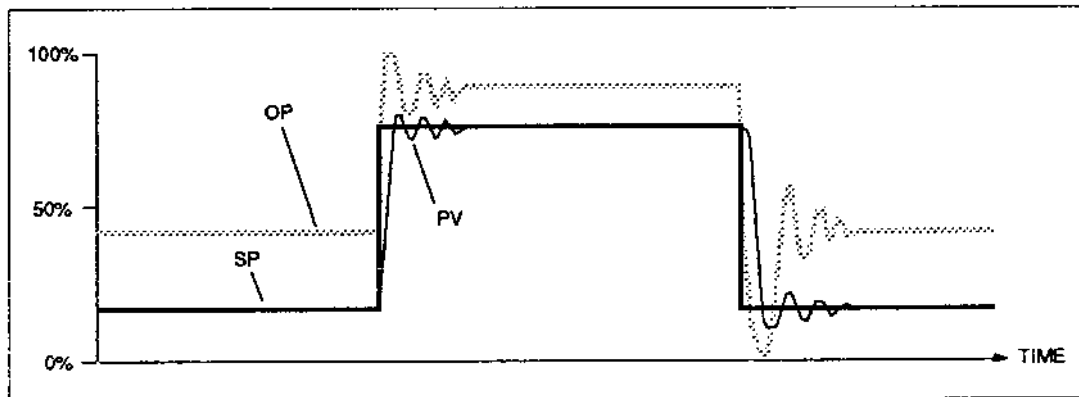

Figure 7.6 Adaptive Gain Responses — With Integral Balance

proportion of PV. Note the 'ringing' in PV caused by the application of integral balance at every XP change. If this feature is undesirable in a particular application it may be better to use XP *bands* rather than continuous XP variation.

Integral Desaturation

With a persistent error (ER), the PID algorithm's integral term ($TS/TL \cdot \sum ER_i$) can accumulate a large value ('integral term wind-up'), which begins to reduce only after ER has reversed. When large enough the integral accumulator holds the controller output against an output limit, and even whilst reducing it continues to do so for a further *dead-time* period until it has emptied sufficiently. The upper part of Figure 7.7 shows this effect schematically.

Integral desaturation eliminates this dead-time, allowing the output to move away from the limit as soon as the error reverses, and so avoids large PV overshoots. It does this by suspending integral action when an output limit is

CONTROL LOOP OPERATING MODES

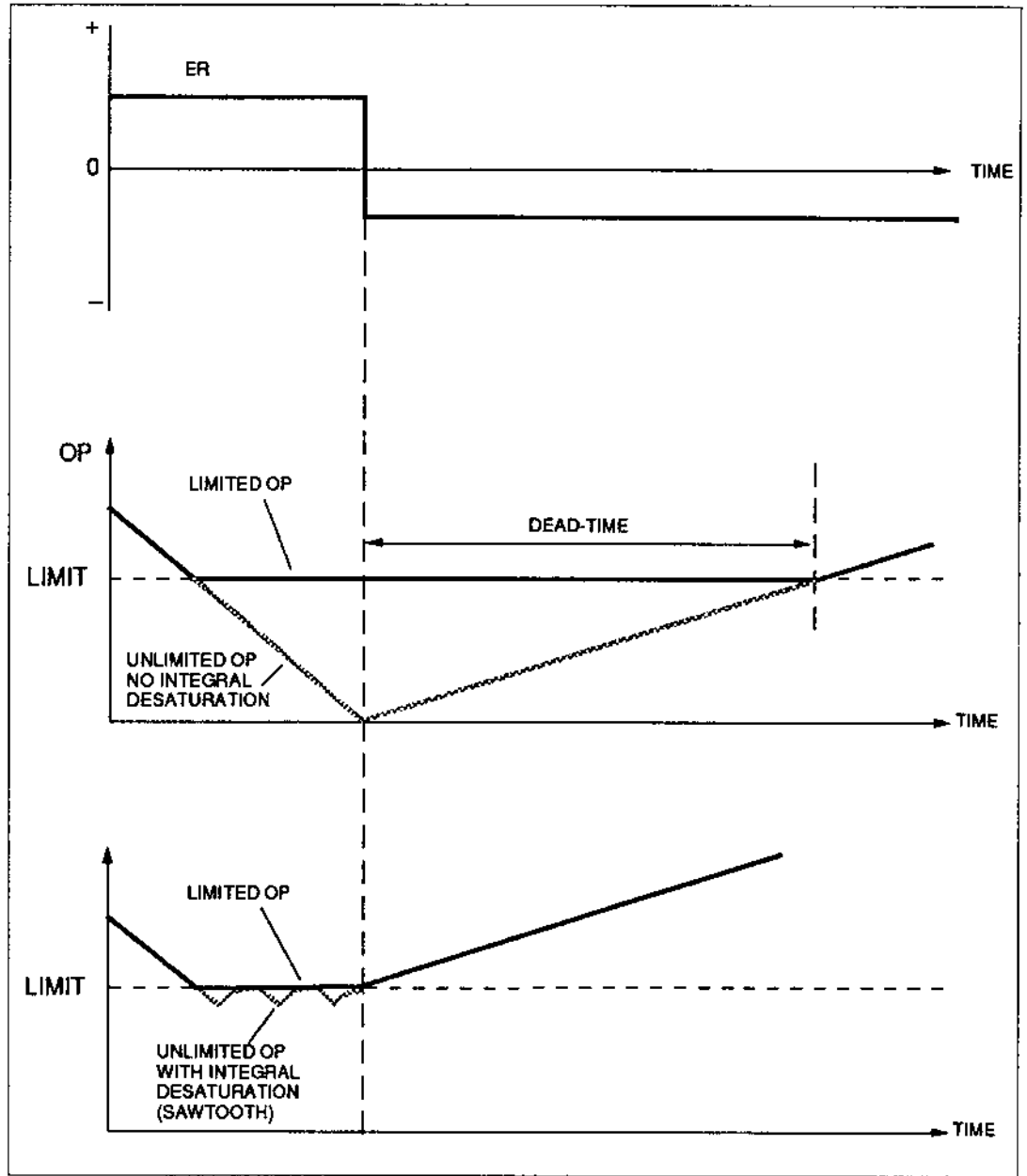

Figure 7.7 Effect of Integral Desaturation (Integral Action)

exceeded, and 'bleeding off' the integral accumulator until the calculated PID output is back on limit. At this point normal integral action is resumed. Integral desaturation is repeatedly activated if necessary to keep the output near the limit, until the error reverses. This is shown schematically in the lower part of Figure 7.7.

In this example the control action is *Integral only*, for clarity. The 'sawtooth' effect in the unlimited output arises from the repeated application of integral desaturation to bring it back to the limit. This is of course not seen in the limited output passed on to the plant.

Limit Detection. Approach to a limit is detected by comparing (at each iteration) the calculated output value OP with the corresponding feedback value FB, which has been limited in the manual station. If these differ by more than a small margin a limit is judged to have been reached and integral desaturation starts. Figure 7.8 shows this schematically. (Mathematical details are given later.)

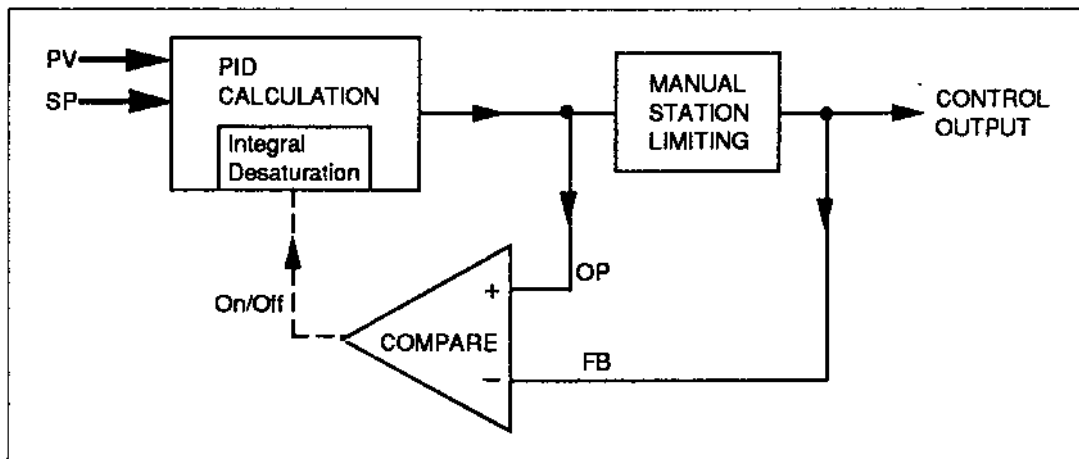

Figure 7.8 Application of Integral Desaturation (Schematic)

The margin between OP and FB needed to trigger integral desaturation is very small (.006% approx.), so the feedback signal should come directly from the manual station output whenever possible. FB can originate elsewhere provided excessive time delays in the feedback loop are avoided. Delays longer than the sample time (TS) could cause the feedback to differ from the last output enough to trigger unwanted integral desaturation, which would slow down the controller action.

Effect of Integral Desaturation on Dynamics. Figure 7.9 shows a more realistic example where integral desaturation is preventing excessive overshoot in a full PID control application. For comparison, Figure 7.10 shows the same setup *without* integral desaturation.

CONTROL LOOP OPERATING MODES

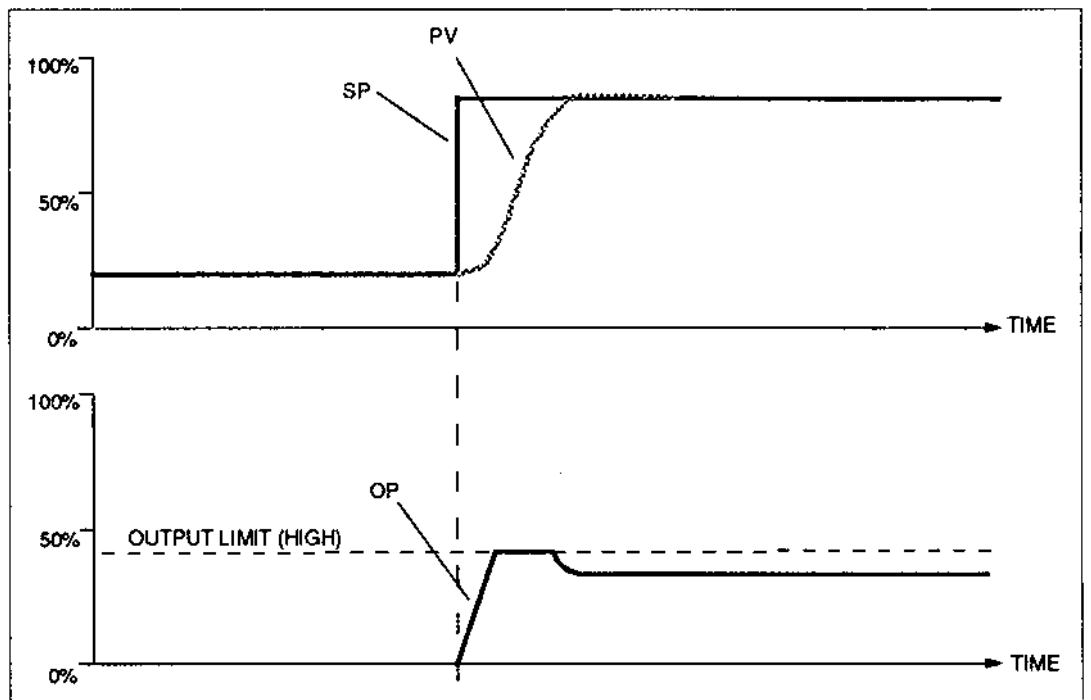

Figure 7.9 Application With Integral Desaturation (PID Action)

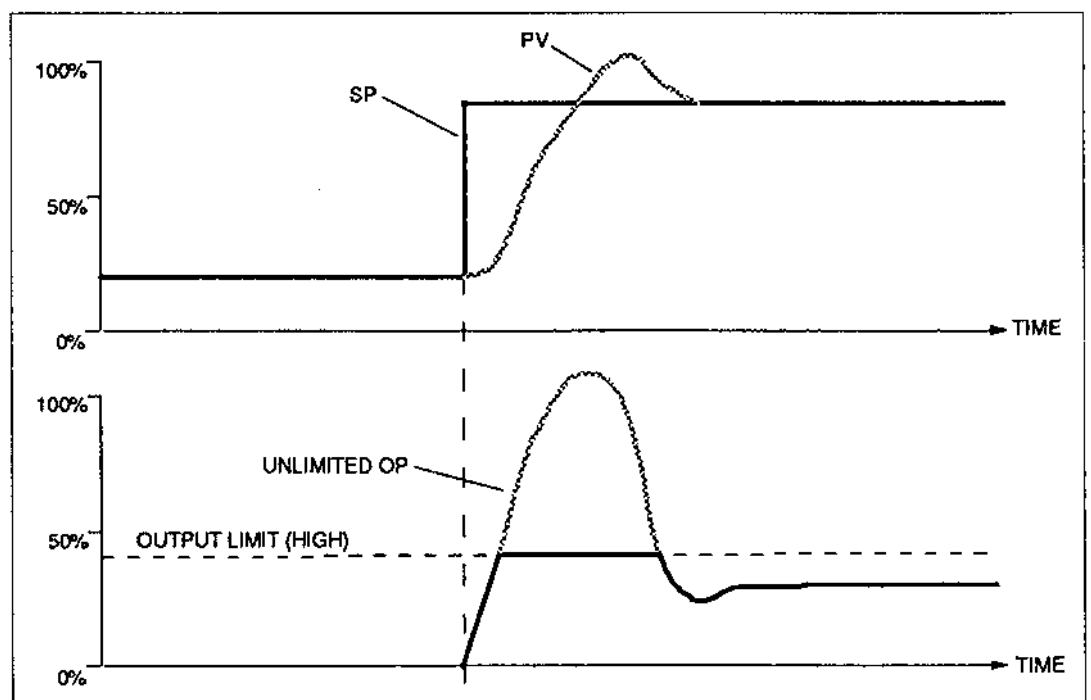

Figure 7.10 Application Without Integral Desaturation (PID Action)

Mathematical Implementation

Definition of Terms

OP	= PID output
XP	= Proportional band
ER	= Error (PV-SP)
TS	= Sample time (algorithm iteration period)
TI	= Integral time constant
TD	= Derivative time constant
FF	= Feed-forward value
FB	= Feedback value (normally $FB_n = OP_{n-1}$)
ΔPV	= $PV_n - PV_{n-1}$ (filtered)
PD	= Combined Proportional and Derivative term
I	= Integral term

(Subscripts denote algorithm iteration number)

In TCS instruments, the PID output algorithm is usually written in general terms as:

$$OP = \frac{-100}{XP} \left[ER + \frac{TS}{TI} \sum ER_i + \frac{TD}{TS} \Delta PV \right] + FF$$

The flow diagram in Figure 7.11 shows how integral balance and integral de-saturation are actually applied in the PID algorithm at each iteration. In the diagram, the proportional and derivative terms are combined for clarity into a single term:

$$PD_n = ER_n + \frac{TD_n}{TS_n} \Delta PV_n$$

and the standard integral term is called:

$$I_n = I_{n-1} + \frac{TS_n}{TI_n} ER_n$$

Balancing the Integral Term. Figure 7.11 shows the 'balancing' of the integral term as setting:

$$I_n = \frac{-XP_n}{100} [FB_n - FF_n] - PD_n + \frac{TS_n}{TI_n} ER_n$$

CONTROL LOOP OPERATING MODES

To see the effect this has on the calculated output, this balanced I_n can be substituted into the equation defining OP_n , which gives the result:

$$OP_n = FB_n - \left[\frac{100}{XP_n} \frac{TS_n}{TI_n} ER_n \right]$$

that is, OP_n (balanced) = OP_{n-1} (limited) - integral increment

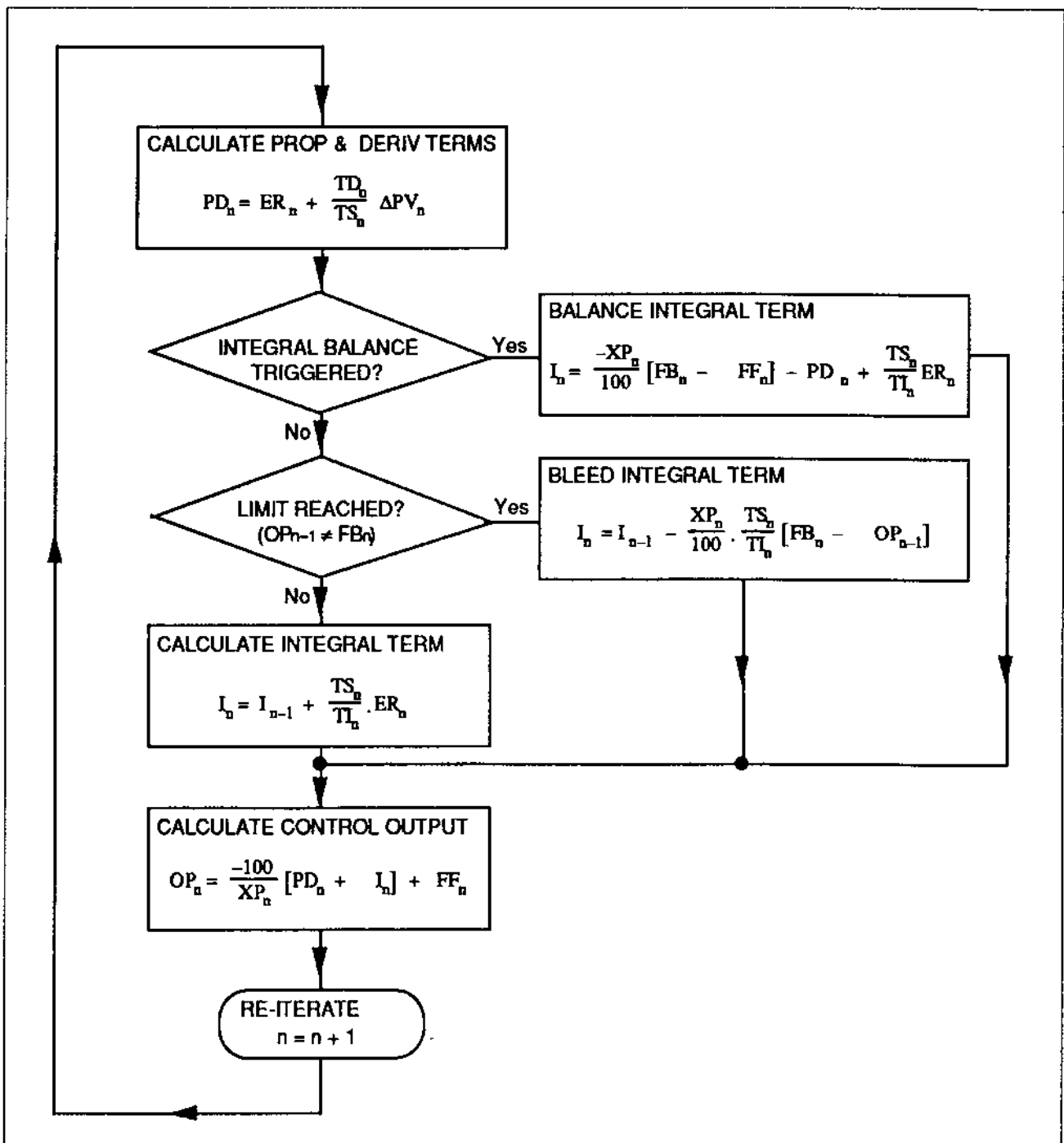

Figure 7.11 Implementation of Integral Balance & Integral Desaturation

(Because of the way the algorithm is executed the feedback at the n th iteration, FB_n , is derived from the output at the *previous* iteration, OP_{n-1} .) So balancing the integral term in this way results in the new output differing from the previous (limited) output by the integral term increment only, with no contribution from the proportional or derivative terms.

'Bleeding' the Integral Term. Figure 7.11 shows that each time integral desaturation is applied the integral term is reduced by the quantity:

$$\frac{XP_n}{100} \cdot \frac{TS_n}{TI_n} [FB_n - OP_{n-1}]$$

that is, by an amount proportional to $FB_n - OP_{n-1}$, the margin the calculated output is over limit. This causes the output to approach the limit exponentially until the margin is small enough (<0.006% approx.) not to trigger integral desaturation.

Chapter 8

COMPUTER SUPERVISION OF INTELLIGENT LOOP PROCESSORS

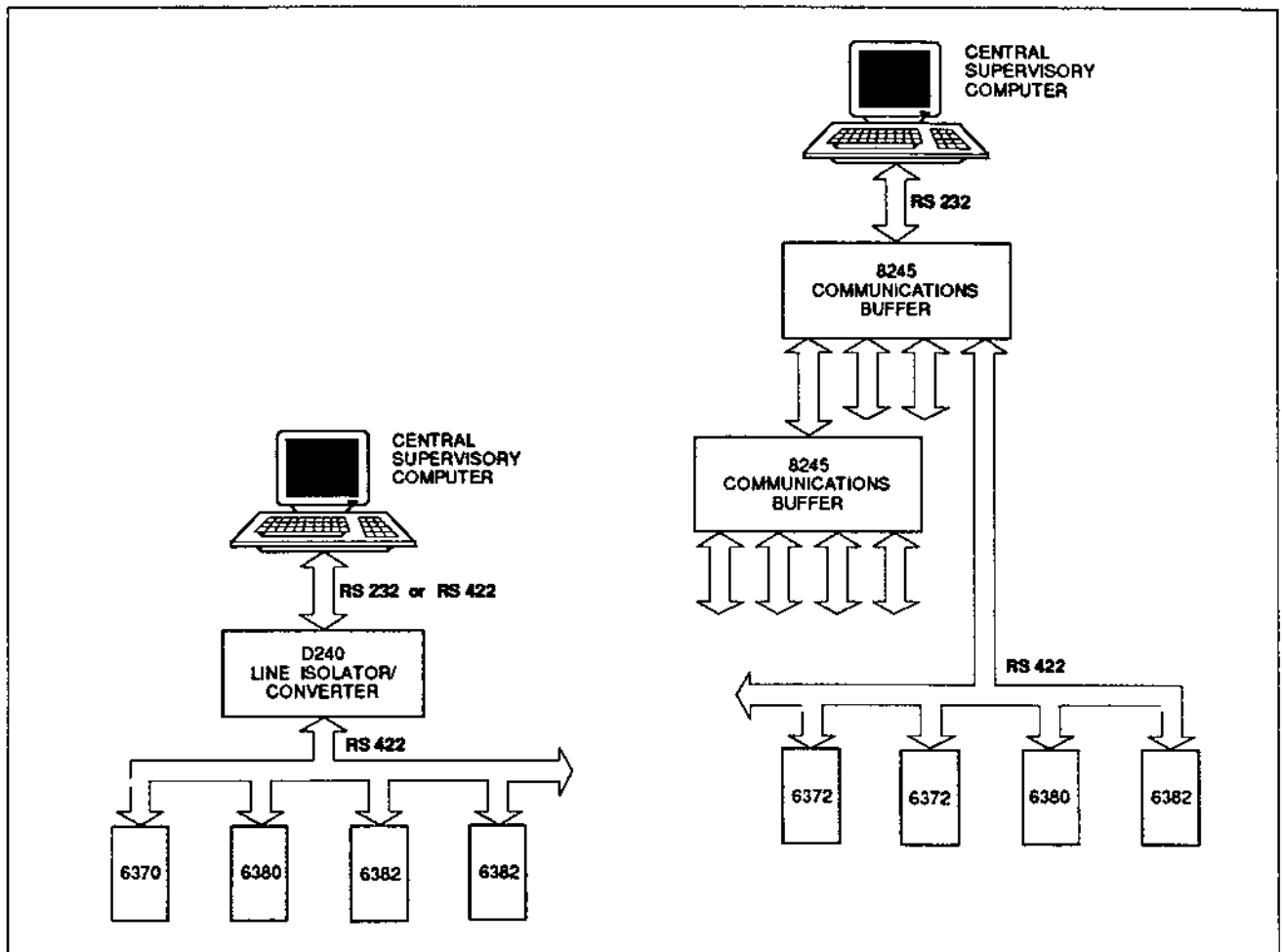

Figure 8.1 Multi-Drop Supervisory Systems—Possible Configurations

This chapter deals mainly with aspects of the computer supervision of 6370/80 Series Intelligent Loop Processors that are specific to these instruments. Other TCS publications, referred to below, give more general information.

Serial Data Communications

All Intelligent Loop Processors are fitted with a serial data communications port, accessible via either an RS232 socket on the front panel, or RS422 connectors at the rear of the instrument.

The RS232 Data Link. The front panel RS232 socket is used to connect the 8263 Hand-Held Terminal, or a computer/VDU terminal. It allows local operators to communicate on a one-to-one basis when entering the parameters needed to configure a control strategy.

The front panel socket has priority over the rear connectors: RS422 communications cease if a terminal is plugged into the RS232 socket.

The RS422 Data Link. RS422 communications are available on the module rear connector pins 35 to 38. The RS422 connectors of a number of Intelligent Loop Processors may be bussed onto a supervisory data link connected to a remote supervisory computer or other Intelligent device. Figure 8.1 shows such a configuration together with other possible arrangements. The bus structure allows the supervisory computer to monitor or update the parameters of a whole network of Loop Processors and other System 6000 instruments.

This 'multi-drop' supervisory link approach is applicable to all System 6000 instruments, and full details of the hardware and software required are given in the specialist TCS publications referred to below.

Serial Data Transmission. Chapter 1 of the 6370/80 Series User Guide (*Installation & Power-Up*) briefly covers the use of motherboard switchbanks SW1 and SW2 to set up the RS422 baud rate, Group Identifier (GID), and Unit Identifier (UID). Figure 8.2 reminds you of the motherboard switchbanks. GID and UID values are simply the binary number formed by the relevant switch pattern; 'on' is equivalent to 1 and 'off' to 0. The decimal value of each GID and UID switch is shown in Figure 8.2.

A more complete description is given in Section 4 of the *System 6000 Communications Handbook* (part no. HA 076 568) together with information on RS422 characteristics and technical specification, serial data transmission, binary synchronous communications data link control, and instrument group and unit addressing.

COMPUTER SUPERVISION

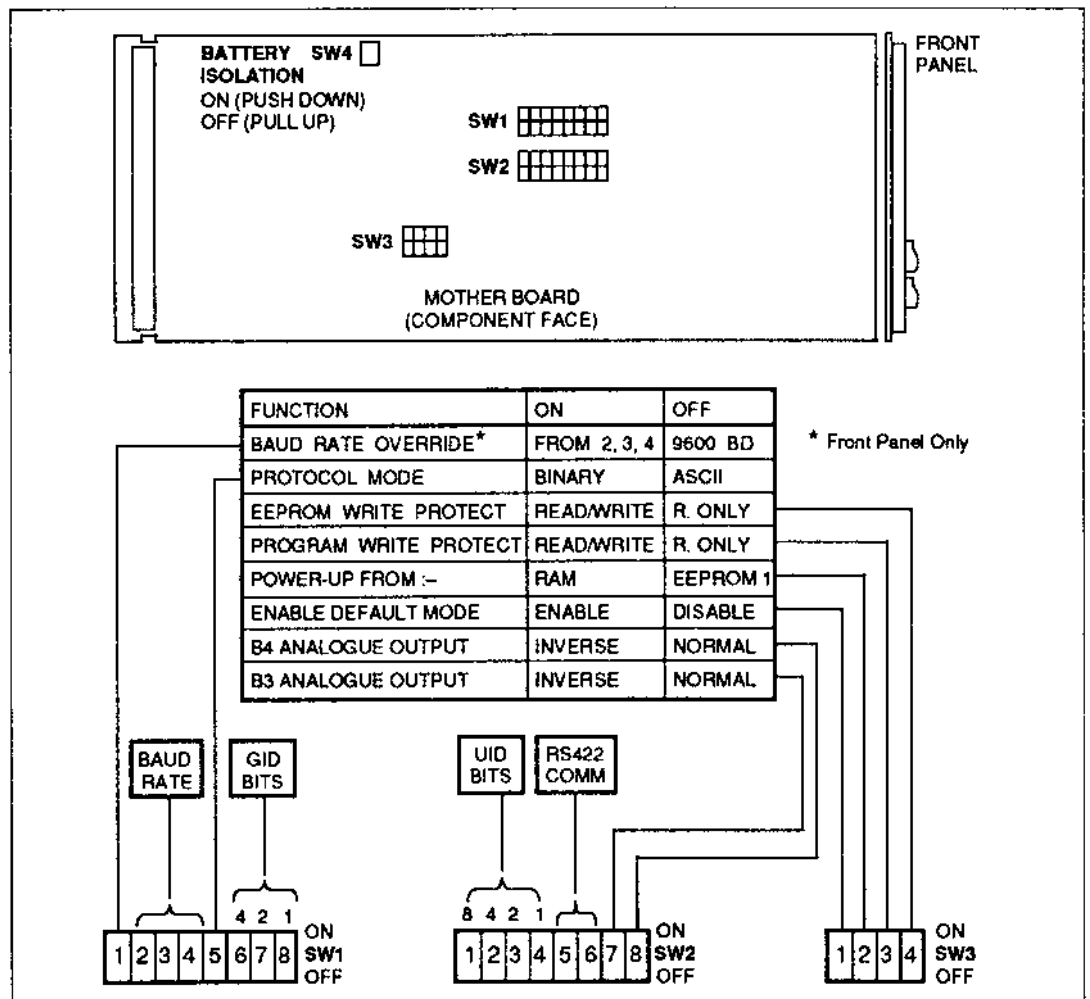

Figure 8.2 Motherboard Switch Functions

Communications Protocol

All data transfers between Intelligent Loop Processors and a supervisory computer via the RS422 data link are carried out using a communications protocol. TCS has chosen an ANSI standard protocol called BISYNC (Binary Synchronous) for System 6000 instruments and this is known by the abbreviation X3.28.

The Intelligent Loop Processors can operate this protocol in either *ASCII* or *Binary* modes depending on the setting of switchbank SW1 switch 5 (see Figure 8.2). ASCII mode sends all data as ASCII characters, making it easy to use with languages like BASIC, PASCAL, and FORTRAN. Binary mode is, however, much more efficient because messages are transmitted in a more compressed format.

ASCII Protocol

For full and general details of the ASCII mode of the protocol, please refer to the *System 6000 Communications Handbook*, section 5. What follows is information more specific to the Intelligent Loop Processor series of instruments.

In these instruments the ASCII protocol is used to send three basic message types:

- **Accessing Command Mode (??CMD) Parameters.** The *Command Mode* parameters (listed in Table 6.1 in Chapter 6) can be accessed via their standard two ASCII character command mnemonics, e.g. II, or SW. No block address is needed.

A typical message contains the following sequence of six ASCII characters, with square brackets '[']' denoting a single character:

[GID] [GID] [UID] [UID] [C1] [C2]

The functions of these characters are:

[GID] [GID]

These two data characters are the Group Address Identifier (in hexadecimal format) repeated twice for security. The Group Identifier is set up on switches 6, 7 and 8 of switchbank SW1 (Figure 8.2).

[UID] [UID]

These two characters are the Unit Address Identifier (hex), also repeated twice for security. The Unit Identifier is set up on switches 1 to 4 of switchbank SW2.

[C1] [C2]

These two alphanumeric characters specify the required command mode parameter mnemonic e.g. [C1] = I and [C2] = D is the ID parameter, etc.

NOTE. All the command mode parameters are *read-only* via the ASCII protocol.

Example The sequence of characters 6 6 F F S W sent by the supervisory computer accesses the instrument with GID = 6, UID = 15 (F hex), and its SW 'mother-board switch settings' parameter. The instrument responds with the value of SW, as four hexadecimal digits.

■ **Accessing/Assigning Blocks at Addresses.**

This kind of ASCII message is used to access the function block at a given address, or to assign a block to that address. A complete list of blocks and their addresses for each of the instruments in the series is given in Table 4.1 of Chapter 4.

A typical message contains the following sequence of ASCII characters:

[GID] [GID] [UID] [UID] [B1] [B2] [=]

The functions of these characters are:

[GID] [GID] [UID] [UID]

These are the Group and Unit Identifiers as described in the previous section on command mode parameters.

[B1] [B2]

These two characters are the block address, e.g. [B1] = A and [B2] = 1 (address A1).

[=]

This character is used as an optional delimiter. If it is present the message is being used to assign a block to an address. If absent, the message elicits the name of the block already there.

Example 1 The message 5 5 C C 0 1 sent by the computer causes the instrument with GID = 5 and UID = 12 (C hex) to respond with the name of the assigned block at address 01 (e.g. ADD2).

Example 2 The message 5 5 C C 0 1 = ' A D D 2 assigns an ADD2 block to address 01 of the same instrument. (The ' character denotes string variables to follow, 'ADD2' in this case.)

■ **Accessing a Block Parameter .** This message type is used to access the individual block parameters. It can either elicit the existing parameter value, or write in a new value. A typical message contains the following sequence of ASCII characters:

[GID] [GID] [UID] [UID] [B1] [B2] [C1] [C2]

The functions of these characters are:

[GID] [GID] [UID] [UID] [B1] [B2]

These are the Group and Unit Identifiers and the block address, as described above in previous sections.

[C1] [C2]

These two characters are the parameter mnemonic within the block, e.g. HA, etc.

Example 1 The message 5 5 C C 0 1 F C sent by the computer causes the instrument with GID = 5 and UID = 12 to respond with the value of the FC (function control) parameter of the block at address 01 (e.g. ADD2).

Example 2 The message 5 5 C C 0 1 F C > 0 2 1 E writes the four hex digits 021E to the FC parameter of the block at address 01 of the same instrument. (The > character denotes hexadecimal digits to follow, '021E' in this case.)

Binary Protocol

For full and general details of the binary mode of the protocol, please refer to the *System 6000 Communications Handbook*, section 6. What follows is information more specific to the Intelligent Loop Processor series of instruments.

Intelligent Loop Processors can emulate the parameters of the following TCS instruments in the binary protocol mode:

- 6370/80/72/82 Intelligent Loop Processors
- 6350/60/56/66 Process Controllers
- 6432 Signal Processor

Instrument Parameter Number (PNO). Each instrument parameter has a 7-bit number associated with it, called the Parameter Number (PNO), covering the range 0 to 127. All the possible PNOs for this series of instruments are given in Tables 8.2 to 8.9, at the end of this chapter.

Writing an instrument identity to the II parameter (see Chapter 6) selects which set of instrument parameters is to be emulated, and also to which Table of PNOs you should refer. Then, setting switches 5 and 6 of Switchbank SW2 (Figure 8.2) selects the required RS422 capability within that parameter set.

NOTE. Writing to II can only be done using the Hand-Held Terminal, because II is read-only via the RS422 communications.

Instrument Number (INO). In the binary mode of the protocol, the Group Identifier (GID) and Unit Identifier (UID) are combined into a single 7-bit number called the *Instrument Number* (INO). INO bits 0-3 contain the UID bits, and INO bits 4-6 contain the GID bits (Figure 8.3). The INO decimal value, equal to $(16 \times \text{GID}) + \text{UID}$, ranges from 0 to 127. Actually, bit 7 is also used to show mode.

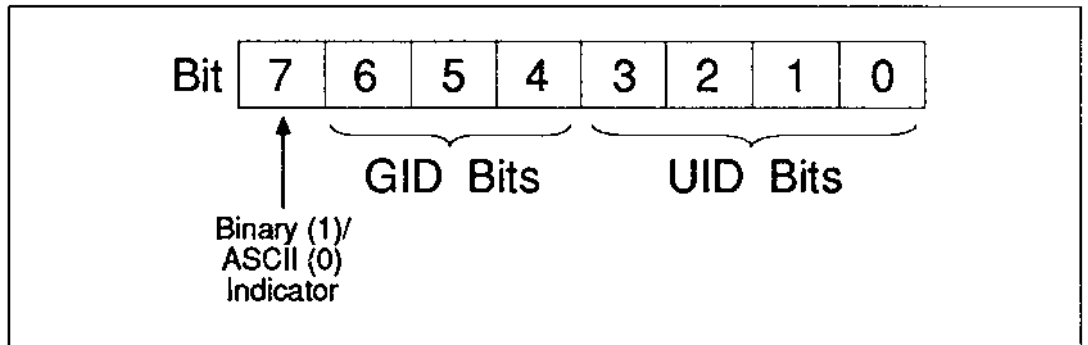

Figure 8.3 *Instrument Number (INO) Bits*

INO is the overall instrument address. It also acts as a datum from which the addresses of the different loop parameter sets *within* an emulated instrument are calculated.

Table 8.1 shows the addresses (based on INO) of the possible parameter sets. The type of instrument being emulated is determined by the ID of your instrument and what you have written to the II parameter. All possibilities are shown in the table.

Which sub-set of the complete range of instrument parameters you can access is determined by the settings of switches 5 and 6 of motherboard switchbank SW2 (Figure 8.2). (The bigger the sub-set the more addresses it uses up in the communications system.)

INOs can sometimes take only certain values, depending on the parameter sub-sets in use. Table 8.1 shows these permissible values.

SW2		Instrument Parameter Subset	Subset Address	INOs Allowed
5	6			
Off	Off	(No Loops accessible)		
On	Off	6372/82 Loop 1	INO + 0	(Any)
Off	On	6372/82 Loop 2	INO + 0	(Any)
On	On	6372/82 Loop 1 6372/82 Loop 2	INO + 0 INO + 1	0, 2, 4, 6, 8,

Table 8.1 *Instrument Parameter Subset Addresses*

NOTE. Table 8.1 applies only to 6372/82 instruments, which have two loops and pseudo I/O communications blocks, enabling them to emulate the 32 I/O channels of 6432 instruments. For 6370/80 instruments, switches 5 and 6 of switchbank SW2 are not used (and have no effect). II and ID alone determine the parameter set available. When II is set to 3568 or 3668, switch 6 is 'don't care' and switch 5 is OFF for 1 loop, ON for 2 loops.

Example *Accessing the ST parameter of the loop 2 Lead/Lag (LLAG) block in a 6382 instrument.*

- Set switchbank SW2 switches 5, 6 to Off, On respectively. This allows access to loop 2, at comms address [INO]. Please refer to Table 8.1
- Refer to Table 8.4 for the parameter numbers (PNOs) in loop 2 of a 6382 instrument.
- The block address of the loop 2 LLAG function block within the instrument's database is F2. Locate the entry F2.ST in the table, which has a PNO = 103 (decimal).
- The general format of the required message is: [comms. address] [PNO], with square brackets '[']' denoting a single binary number. In this case it is [INO] [103]. The instrument responds with the value of the LLAG block's ST parameter.

Instrument Parameter Numbers

Tables 8.2 to 8.9 list all the PNOs possible for the range of Intelligent Loop Processors.

In each cell of the tables, the first two bold characters are the instrument *block address*, and the second two bold characters (after the period) are the block *parameter mnemonic*. The block address may contain the symbol 'n' which can equal 1 or 2 for blocks that form a pair. The smaller number at the top right of each cell is the corresponding *PNO*.

For example, in Table 8.2 **Mn.ST** is the ST parameter (Status Word) of the Manual Station block at block addresses M1 or M2. The corresponding PNO (for both these blocks) is 88.

0	1	2	3	4	5	6	7
GP . II	Cn . ST	Cn . PH	Cn . PL	Cn . HD	Cn . LD	Cn . MD	Cn . SP
8	9	10	11	12	13	14	15
Cn . PV	Mn . OP	Cn . HA	Cn . LA	Cn . HS	Cn . LS	Mn . HL	Mn . LL
16	17	18	19	20	21	22	23
Cn . HR	Cn . LR	Cn . SL		Cn . XP	Cn . TI	Cn . TD	
24	25	26	27	28	29	30	31
				Cn . RS	Cn . RB		GP . SW
32	33	34	35	36	37	38	39
		Cn . TS	Cn . ER				
40	41	42	43	44	45	46	47
GP . ST	(Dummy)	(Dummy)	(Dummy)	GP . PB			
48	49	50	51	52	53	54	55
A1 . ST	A1 . HR	A1 . LR	A1 . AI	A1 . AV		A2 . ST	A2 . HR
56	57	58	59	60	61	62	63
A2 . LR	A2 . AI	A2 . AV		A3 . ST	A3 . HR	A3 . LR	A3 . AI
64	65	66	67	68	69	70	71
A3 . AV		B1 . ST	B1 . HR	B1 . LR	B1 . HL	B1 . LL	B1 . AO
72	73	74	75	76	77	78	79
DI . ST	DI . XM	DI . DS	DO . ST	DO . WM	DO . DS	Cn . SR	Cn . SB
80	81	82	83	84	85	86	87
Cn . RL	Cn . RA	Cn . RT		Cn . 3T	Cn . FF	Cn . FB	Cn . OP
88	89	90	91	92	93	94	95
Mn . ST	Mn . HV	Mn . LV	Mn . MO	Mn . OT		(Dummy)	(Dummy)
96	97	98	99	100	101	102	103
(Dummy)	(Dummy)	Cn . ES	Cn . SM		En . ST	En . H1	En . L1
104	105	106	107	108	109	110	111
En . H2	En . L2	En . PV	En . SP	En . HY	(Dummy)	(Dummy)	(Dummy)
112	113	114	115	116	117	118	119
(Dummy)	(Dummy)	(Dummy)	Fn . ST	Fn . XK	Fn . 1T	Fn . 2T	Fn . FF
120	121	122	123	124	125	126	127
Fn . FI	Fn . OP	Dn . ST	Dn . DT	Tn . ST	Tn . FS	Tn . FT	

Table 8.2 Parameter Numbers for 6356/66 ($n = 1, 2$)

NOTE. Enquiry Polling is available only for parameters in *shaded* cells.

COMPUTER SUPERVISION

0	1	2	3	4	5	6	7
GP . II	C1 . ST	C1 . PH	C1 . PL	C1 . HD	C1 . LD	C1 . MD	C1 . SP
8	9	10	11	12	13	14	15
C1 . PV	M1 . OP	C1 . HA	C1 . LA	C1 . HS	C1 . LS	C1 . HR	C1 . LR
16	17	18	19	20	21	22	23
C1 . SL	C1 . RL	C1 . XP	C1 . TI	C1 . TD	C1 . SR	C1 . SB	C1 . TS
24	25	26	27	28	29	30	31
C1 . RA	C1 . RT	C1 . RS	C1 . RB	C1 . ER	C1 . 3T	C1 . FF	C1 . FB
32	33	34	35	36	37	38	39
C1 . OP	C1 . ES	C1 . SM	M1 . ST	M1 . HL	M1 . LL	M1 . HV	M1 . LV
40	41	42	43	44	45	46	47
M1 . MO	M1 . OT	M1 . MP	A1 . ST	A1 . HR	A1 . LR	A1 . AV	A2 . ST
48	49	50	51	52	53	54	55
A2 . HR	A2 . LR	A2 . AV	A3 . ST	A3 . HR	A3 . LR	A3 . AV	A4 . ST
56	57	58	59	60	61	62	63
A4 . HR	A4 . LR	A4 . AV	A5 . ST	A5 . HR	A5 . LR	A5 . AV	A6 . ST
64	65	66	67	68	69	70	71
A6 . HR	A6 . LR	A6 . AV	A7 . ST	A7 . HR	A7 . LR	A7 . AV	A8 . ST
72	73	74	75	76	77	78	79
A8 . HR	A8 . LR	A8 . AV	B1 . ST	B1 . HR	B1 . LR	B1 . HL	B1 . LL
80	81	82	83	84	85	86	87
B1 . AO	B2 . ST	B2 . HR	B2 . LR	B2 . HL	B2 . LL	B2 . AO	B3 . ST
88	89	90	91	92	93	94	95
B3 . HR	B3 . LR	B3 . HL	B3 . LL	B3 . AO	B4 . ST	B4 . HR	B4 . LR
96	97	98	99	100	101	102	103
B4 . HL	B4 . LL	B4 . AO	D1 . ST	D1 . DS	DO . ST	DO DS	F1 . ST
104	105	106	107	108	109	110	111
F1 . XK	F1 . 1T	F1 . 2T	F1 . FF	F1 . FI	F1 . OP	D1 . ST	D1 . MT
112	113	114	115	116	117	118	119
D1 . DT	T1 . ST	T1 . FS	T1 . FT	E1 . ST	E1 . H1	E1 . L1	E1 . H2
120	121	122	123	124	125	126	127
E1 . L2	E1 . PV	E1 . SP	E1 . HY	GP . ST	PB	SW	

Table 8.3 Parameter Numbers for 6372/82 Loop 1

0	1	2	3	4	5	6	7
GP . II	C2 . ST	C2 . PH	C2 . PL	C2 . HD	C2 . LD	C2 . MD	C2 . SP
8	9	10	11	12	13	14	15
C2 . PV	M2 . OP	C2 . HA	C2 . LA	C2 . HS	C2 . LS	C2 . HR	C2 . LR
16	17	18	19	20	21	22	23
C2 . SL	C2 . RL	C2 . XP	C2 . TI	C2 . TD	C2 . SR	C2 . SB	C2 . TS
24	25	26	27	28	29	30	31
C2 . RA	C2 . RT	C2 . RS	C2 . RB	C2 . ER	C2 . 3T	C2 . FF	C2 . FB
32	33	34	35	36	37	38	39
C2 . OP	C2 . ES	C2 . SM	M2 . ST	M2 . HL	M2 . LL	M2 . HV	M2 . LV
40	41	42	43	44	45	46	47
M2 . MO	M2 . OT	M2 . MP	A1 . ST	A1 . HR	A1 . LR	A1 . AV	A2 . ST
48	49	50	51	52	53	54	55
A2 . HR	A2 . LR	A2 . AV	A3 . ST	A3 . HR	A3 . LR	A3 . AV	A4 . ST
56	57	58	59	60	61	62	63
A4 . HR	A4 . LR	A4 . AV	A5 . ST	A5 . HR	A5 . LR	A5 . AV	A6 . ST
64	65	66	67	68	69	70	71
A6 . HR	A6 . LR	A6 . AV	A7 . ST	A7 . HR	A7 . LR	A7 . AV	A8 . ST
72	73	74	75	76	77	78	79
A8 . HR	A8 . LR	A8 . AV	B1 . ST	B1 . HR	B1 . LR	B1 . HL	B1 . LL
80	81	82	83	84	85	86	87
B1 . AO	B2 . ST	B2 . HR	B2 . LR	B2 . HL	B2 . LL	B2 . AO	B3 . ST
88	89	90	91	92	93	94	95
B3 . HR	B3 . LR	B3 . HL	B3 . LL	B3 . AO	B4 . ST	B4 . HR	B4 . LR
96	97	98	99	100	101	102	103
B4 . HL	B4 . LL	B4 . AO	DI . ST	DI . DS	DO . ST	DO DS	F2 . ST
104	105	106	107	108	109	110	111
F2 . XK	F2 . 1T	F2 . 2T	F2 . FF	F2 . FI	F2 . OP	D2 . ST	D2 . MT
112	113	114	115	116	117	118	119
D2 . DT	T2 . ST	T2 . FS	T2 . FT	E2 . ST	E2 . H1	E2 . L1	E2 . H2
120	121	122	123	124	125	126	127
E2 . L2	E2 . PV	E2 . SP	E2 . HY	GP . ST	PB	SW	

Table 8.4 Parameter Numbers for 6372/82 Loop 2

COMPUTER SUPERVISION

0	1	2	3	4	5	6	7
GP . II	C1 . ST	C1 . PH	C1 . PL	C1 . HD	C1 . LD	C1 . MD	C1 . SP
8	9	10	11	12	13	14	15
C1 . PV	M1 . OP	C1 . HA	C1 . LA	C1 . HS	C1 . LS	C1 . HR	C1 . LR
16	17	18	19	20	21	22	23
C1 . SL	C1 . RL	C1 . XP	C1 . TI	C1 . TD	C1 . SR	C1 . SB	C1 . TS
24	25	26	27	28	29	30	31
C1 . RA	C1 . RT	C1 . RS	C1 . RB	C1 . ER	C1 . 3T	C1 . FF	C1 . FB
32	33	34	35	36	37	38	39
C1 . OP	C1 . ES	C1 . SM	M1 . ST	M1 . HL	M1 . LL	M1 . HV	M1 . LV
40	41	42	43	44	45	46	47
M1 . MO	M1 . OT	M1 . MP	A1 . ST	A1 . HR	A1 . LR	A1 . AV	A2 . ST
48	49	50	51	52	53	54	55
A2 . HR	A2 . LR	A2 . AV	A3 . ST	A3 . HR	A3 . LR	A3 . AV	A4 . ST
56	57	58	59	60	61	62	63
A4 . HR	A4 . LR	A4 . AV	(Dummy)	(Dummy)	(Dummy)	(Dummy)	(Dummy)
64	65	66	67	68	69	70	71
(Dummy)	(Dummy)	(Dummy)	(Dummy)	(Dummy)	(Dummy)	(Dummy)	(Dummy)
72	73	74	75	76	77	78	79
(Dummy)	(Dummy)	(Dummy)	B1 . ST	B1 . HR	B1 . LR	B1 . HL	B1 . LL
80	81	82	83	84	85	86	87
B1 . AO	B2 . ST	B2 . HR	B2 . LR	B2 . HL	B2 . LL	B2 . AO	B3 . ST
88	89	90	91	92	93	94	95
B3 . HR	B3 . LR	B3 . HL	B3 . LL	B3 . AO	B4 . ST	B4 . HR	B4 . LR
96	97	98	99	100	101	102	103
B4 . HL	B4 . LL	B4 . AO	DI . ST	DI . DS	DO . ST	DO DS	(Dummy)
104	105	106	107	108	109	110	111
(Dummy)	(Dummy)	(Dummy)	(Dummy)	(Dummy)	(Dummy)	(Dummy)	(Dummy)
112	113	114	115	116	117	118	119
(Dummy)	(Dummy)	(Dummy)	(Dummy)	E1 . ST	E1 . H1	E1 . L1	E1 . H2
120	121	122	123	124	125	126	127
E1 . L2	E1 . PV	E1 . SP	E1 . HY	GP . ST	PB	SW	

Table 8.5 Parameter Numbers for 6370/80

	0	1	2	3	4	5	6	7
	II	S1	A1	S2	A2	S3	A3	S4
	8	9	10	11	12	13	14	15
	A4	SW	MD					ID
Ch 1	16	17	18	19	20	21	22	23
	n1 . ST	n1 . HR	n1 . LR	n1 . HA	n1 . LA	n1 . AV	(Dummy)	
Ch 2	24	25	26	27	28	29	30	31
	n2 . ST	n2 . HR	n2 . LR	n2 . HA	n2 . LA	n2 . AV	(Dummy)	
Ch 3	32	33	34	35	36	37	38	39
	n3 . ST	n3 . HR	n3 . LR	n3 . HA	n3 . LA	n3 . AV	(Dummy)	
Ch 4	40	41	42	43	44	45	46	47
	n4 . ST	n4 . HR	n4 . LR	n4 . HA	n4 . LA	n4 . AV	(Dummy)	
Ch 5	48	49	50	51	52	53	54	55
	n5 . ST	n5 . HR	n5 . LR	n5 . HA	n5 . LA	n5 . AV	(Dummy)	
Ch 6	56	57	58	59	60	61	62	63
	n6 . ST	n6 . HR	n6 . LR	n6 . HA	n6 . LA	n6 . AV	(Dummy)	
Ch 7	64	65	66	67	68	69	70	71
	n7 . ST	n7 . HR	n7 . LR	n7 . HA	n7 . LA	n7 . AV	(Dummy)	
Ch 8	72	73	74	75	76	77	78	79
	n8 . ST	n8 . HR	n8 . LR	n8 . HA	n8 . LA	n8 . AV	(Dummy)	
	80	81	82	83	84	85	86	87
	88	89	90	91	92	93	94	95
	96	97	98	99	100	101	102	103
	104	105	106	107	108	109	110	111

Table 8.6 Parameter Numbers for '6432 Analogue Input Boards'*

*In the Intelligent Loop Processor series of instruments the single-channel pseudo analogue input blocks (AICB) assigned to block addresses n1 to n8 (in the range 01 to 80) emulate the analogue inputs of a 6432 Signal Processor. All eight channels need not be assigned, and the n1 to n8 addresses can be in any order.

- NOTE 1.** When the '6432' SW parameter is requested on the comms, the response is actually the 6372/82 instrument SW parameter.
- NOTE 2.** '6432' parameters S1 to S4 (Slots 1 - 4 status) respond only when interrogated at the INO address of the pseudo block(s) emulating the corresponding 'slot'. Slot number and address are specified in a pseudo block's IN parameter (see Chapter 5, Pseudo I/O Blocks, for details). Using the wrong address returns <EOT>.
- NOTE 3.** The parameter numbers inside the bold rectangle are accessible only via the RS422 binary comms, for use by a supervisory computer system. They are not available via the Hand-Held Terminal, ASCII comms, or the instrument's control strategy.

COMPUTER SUPERVISION

	0	1	2	3	4	5	6	7
	I1	S1	A1	S2	A2	S3	A3	S4
	8	9	10	11	12	13	14	15
	A4	SW	MD					ID
Ch 1	16 n1 . ST	17 n1 . HR	18 n1 . LR	19 n1 . AO	20 n1 . HO	21 n1 . LO	22	23
Ch 2	24 n2 . ST	25 n2 . HR	26 n2 . LR	27 n2 . AO	28 n2 . HO	29 n2 . LO	30	31
Ch 3	32 n3 . ST	33 n3 . HR	34 n3 . LR	35 n3 . AO	36 n3 . HO	37 n3 . LO	38	39
Ch 4	40 n4 . ST	41 n4 . HR	42 n4 . LR	43 n4 . AO	44 n4 . HO	45 n4 . LO	46	47
Ch 5	48 n5 . ST	49 n5 . HR	50 n5 . LR	51 n5 . AO	52 n5 . HO	53 n5 . LO	54	55
Ch 6	56 n6 . ST	57 n6 . HR	58 n6 . LR	59 n6 . AO	60 n6 . HO	61 n6 . LO	62	63
Ch 7	64 n7 . ST	65 n7 . HR	66 n7 . LR	67 n7 . AO	68 n7 . HO	69 n7 . LO	70	71
Ch 8	72 n8 . ST	73 n8 . HR	74 n8 . LR	75 n8 . AO	76 n8 . HO	77 n8 . LO	78	79
	80	81	82	83	84	85	86	87
	88	89	90	91	92	93	94	95
	96	97	98	99	100	101	102	103
	104	105	106	107	108	109	110	111

Table 8.7 Parameter Numbers for '6432 Analogue Output Boards'*

*In the Intelligent Loop Processor series of instruments the single-channel pseudo analogue output blocks (AOCB) assigned to block addresses n1 to n8 (in the range 01 to 80) emulate the analogue outputs of a 6432 Signal Processor. All eight channels need not be assigned, and the n1 to n8 addresses can be in any order.

NOTE 1. When the '6432' SW parameter is requested on the comms, the response is actually the 6372/82 instrument SW parameter.

NOTE 2. '6432' parameters S1 to S4 (Slots 1 - 4 status) respond only when interrogated at the INO address of the pseudo block(s) emulating the corresponding 'slot'. Slot number and address are specified in a pseudo block's IN parameter (see Chapter 5, Pseudo I/O Blocks, for details). Using the wrong address returns <EOT>.

	0	1	2	3	4	5	6	7
	II	S1	A1	S2	A2	S3	A3	S4
	8	9	10	11	12	13	14	15
	A4	SW	MD					ID
Ch 1-8	16	17	18	19	20	21	22	23
	n. ST	n. WM	n. DS					
	24	25	26	27	28	29	30	31
	32	33	34	35	36	37	38	39
	40	41	42	43	44	45	46	47
	48	49	50	51	52	53	54	55
	56	57	58	59	60	61	62	63
	64	65	66	67	68	69	70	71
	72	73	74	75	76	77	78	79
	80	81	82	83	84	85	86	87
	88	89	90	91	92	93	94	95
	96	97	98	99	100	101	102	103
	104	105	106	107	108	109	110	111

Table 8.8 *Parameter Numbers for '6432 Digital Input Boards'**

*In the Intelligent Loop Processor series of instruments the eight-channel pseudo digital input block (DICB) assigned to block address n (in the range 01 to 80) emulates the digital inputs of a 6432 Signal Processor.

- NOTE 1.** When the '6432' SW parameter is requested on the comms, the response is actually the 6372/82 instrument SW parameter.
- NOTE 2.** '6432' parameters S1 to S4 (Slots 1 - 4 status) respond only when interrogated at the INO address of the pseudo block emulating the corresponding 'slot'. Slot number and address are specified in a pseudo block's IN parameter (see Chapter 5, Pseudo I/O Blocks, for details). Using the wrong address returns <EOT>.

COMPUTER SUPERVISION

	0	1	2	3	4	5	6	7
	II	S1	A1	S2	A2	S3	A3	S4
	8	9	10	11	12	13	14	15
	A4	SW	MD					ID
Ch 1-8	16	17	18	19	20	21	22	23
	n. ST	n. XM	n. DS					
	24	25	26	27	28	29	30	31
	32	33	34	35	36	37	38	39
	40	41	42	43	44	45	46	47
	48	49	50	51	52	53	54	55
	56	57	58	59	60	61	62	63
	64	65	66	67	68	69	70	71
	72	73	74	75	76	77	78	79
	80	81	82	83	84	85	86	87
	88	89	90	91	92	93	94	95
	96	97	98	99	100	101	102	103
	104	105	106	107	108	109	110	111

Table 8.9 Parameter Numbers for '6432 Digital Output Boards'*

*In the Intelligent Loop Processor series of instruments the eight-channel pseudo digital output block (DOCB) assigned to block address n (in the range 01 to 80) emulates the digital outputs of a 6432 Signal Processor.

- NOTE 1.** When the '6432' SW parameter is requested on the comms, the response is actually the 6372/82 instrument SW parameter.
- NOTE 2.** '6432' parameters S1 to S4 (Slots 1 - 4 status) respond only when interrogated at the INO address of the pseudo block that is emulating the corresponding 'slot'. Slot number and address are specified in a pseudo block's IN parameter (see Chapter 5, Pseudo I/O Blocks, for details). Using the wrong address returns <EOT>.



Chapter 9

TASK SCHEDULING

Intelligent Loop Processors perform all their in-built and user-programmed instructions *serially*, i.e. one at a time. This chapter describes the scheduling of these various software functions ('tasks') within the instrument, including the three User Tasks, Loops 1 and 2, and the Background Program. An understanding of the timings and priorities of these tasks helps you to use the instrument at maximum efficiency. Table 9.1 summarises the task scheduling, and further explanation is given after the table.

Priority	Function	Schedule
1. Task 1	Instrument supervisory (RS422) comms.	Event driven
2. Task 2	Instrument real I/O updates	Every 9ms
3. Task 3	Maintenance routines (Hand-Held Terminal, front panel, diagnostics, etc.)	Every 112ms
4. User Task 1	Loop 1 block-structured program	Every 100ms (or multiple)
5. User Task 2*	Loop 2 block-structured program	Every 100ms (or multiple)
6. User Task 3†	Background program	Unscheduled

*Not 6370/80

†Dummy program in 6370/80

Table 9.1 6370/80 Series Task Scheduling

Task 1 — RS422 Supervisory Communications

Task 1 has the highest priority and runs immediately when requested by the external supervisory system, interrupting *all* other tasks. When Task 1 is completed, the task with the next highest priority continues running where it left off.

Task 2 — Instrument Real I/O Updates

Task 2 is run by the scheduler every 9 milliseconds, subject to interruptions from Task 1. During Task 2 a set of analogue and digital inputs from the field is measured and the corresponding block parameters updated with the new values (although these values are not yet passed into the strategy). The outputs to the field are updated with the existing output block parameter values (which have not yet been updated from the control strategy). The blocks are scanned in sequence; e.g. only one AI and one AO parameter is updated each 9ms. This means that each 6372/82 AI is updated every 72ms (36ms for 6370/80), and each AO is updated every 36ms.

Task 3 — Maintenance Routines

Task 3 runs every 112 milliseconds, subject to interruptions from Tasks 1 and 2. During this task the Hand-Held terminal, front panel displays and pushbuttons etc. are read/updated, and hardware IDs, battery state, and other house-keeping and diagnostic monitoring functions carried out.

User Task 1 — Loop1 Block-Structured Program

User Task 1 is run by the scheduler every 100 milliseconds, or a multiple of this, subject to interruptions from higher priority tasks. The schedule period in operation is held in the *Loop 1 Repeat Time (L1)* parameter for the loop.

NOTE. Provided there are no control blocks in the loop you can input an L1 value via the General Purpose block. (L1 defaults to 3 seconds if the input is unconnected.) With control blocks present the scheduler runs the loop as often as possible and in this case you should *not* generally input to L1.

User Task 1 consists of a single execution of all function blocks in Loop 1, in the proper order, and its automatic scheduling (in the presence of a control block) depends on how long it takes to do this. This depends in turn on the number and type of function blocks and links in the loop. 100ms is the minimum schedule period, but if execution takes longer than this L1 is automatically rounded up to the nearest multiple of 100ms.

Control Blocks. The execution of *control blocks* in the loop is treated in a special way. In a control block, the PID calculation must be performed, and the block output value updated, once every *Algorithm Sampling Period (TS)*. TS is self-setting and depends on TI and TD. It is never less than the loop repeat time.

TASK SCHEDULING

When TS *equals* the loop repeat time there is no problem in having the control block fully execute every time the User Task is scheduled. But if TS turns out to be *greater than* the loop repeat time, the control block cannot recalculate the PID output every time the task runs. Instead, it freezes the output and updates only the other parameters (PV, SP etc.), until its internal timer indicates that a time not less than TS has elapsed. Only then, possibly after many loop repeats, does the control block run the PID algorithm (using the actual TS value), reset its internal timer, and update its output with the new value.

User Task 2 — Loop2 Block-Structured Program

(*Not 6370/80 instruments*) User Task 2 corresponds to the Loop 2 program and is handled in the same way as User Task 1, except that it has lower priority, running only after User Task 1 has finished. The loop repeat time is L2, which can be user-set when no control blocks are in the loop, but is otherwise optimised by the scheduler automatically.

User Task 3 — Background Program

User Task 3, the 'background program', has the lowest priority of all the tasks. It is unscheduled, running only when no other task is active, and cannot contain any control blocks.

Watchdog Timer. The background program performs the vital function of resetting the watchdog timer every time one of its program instructions has been executed. This means that if User Task 3 is prevented from completing even a single instruction for more than 500ms, watchdog failure occurs. Therefore the watchdog, via the background program, indirectly monitors all tasks. If *any* task takes too long to complete for any reason, leaving no time available for User Task 3 to run, the watchdog trips.

NOTE. In 6370/80 instruments User Task 3 is an inaccessible *dummy program* only, but it does reset the watchdog timer.

The Intelligent Scheduler. Although Task 1 is event-driven and Tasks 2 and 3 have fixed schedules, User Tasks 1 and 2 (when they contain control loops) are constantly adjusted by the scheduler to run as often as possible, subject to higher priorities. The scheduler automatically runs them *less* often if higher tasks become overloaded and would otherwise suppress the background program long enough to trip the watchdog.

Excessive Loop Repeat Times & Watchdog Failure

As a general guide the loop repeat times for User Tasks 1 and 2 (L1 and L2) should not together total more than 500ms. This assumes both loops contain control blocks and the L1 and L2 inputs are not connected to. If their sum exceeds 500ms watchdog failure is likely to occur despite the efforts of the intelligent scheduler.

Checking Loop Repeat Times. Measuring the working values of L1 and L2 realistically should be done with all the RS422 communications operating, as Task 1 (comms activity) can extend loop repeat times via the intelligent scheduler. Having the comms connected means that you cannot at the same time simply plug in the Hand-Held Terminal to read the L1 and L2 parameters: this would disable the RS422 rear-panel socket. Also, L1 and L2 are not accessible via the RS422 binary comms. One solution is to display the parameters on the front panel in *display mode* via a Display block. Another is to infer the loop repeat times from the corresponding TS parameters, which *are* available on the comms. If you make TS as short as possible (via TI and TD) TS is automatically made *equal* to the loop repeat time.

Reducing Loop Repeat Times. If you do find excessive loop repeat times and cannot design your control strategy with fewer or faster blocks, it may be possible to move some of the slower blocks into User Task 3, the background program, which is unscheduled.

An alternative and less attractive option is to bypass the scheduler, which is actually causing the problem by trying to run the loops as often as possible, and to input your own longer loop repeat time for one of the loops. You can do this by connecting, for example, a Constants block to the L1 (or L2) input of the General Purpose block in the nominated loop. Set the GENP block to the lowest priority (FF), and make the loop repeat time about 200ms longer than the worst-case value you measured for the loop. Now the loop is forced to run less often (which may adversely affect its control), but this allows the background program to run more often, preventing watchdog failure.

NOTE. You can monitor watchdog failure via the instrument power fail bit 9, in the General Purpose block. Bit 9 latches to logic 1 on watchdog trip as well as on power fail.

Connecting Blocks Between Loops — Task Scheduling Implications

User Tasks 1 and 2 may run at different as well as varying loop repeat rates, and the unscheduled background program runs as and when it can. This has implications for control strategies that pass signals from one loop to another, particularly short pulses or edges. For example a logic 1 output generated in a Loop 1 block may persist for only one loop cycle, before resetting to logic 0 at the second cycle. If this digital signal is being input to a block in Loop 2, which happens to be running at only half the Loop 1 rate, it will have reset before the slower Loop 2 destination block has had a chance to update its input. That is, the signal will be lost. This could mean, for example, a Digital Output block missing counts from a Totaliser block.

You are therefore recommended not to pass digital signals between loops unless you can control or take account of the relative loop repeat rates. This is particularly true if the background program is involved.

Transmitting Digital Pulses to the Field. A Digital Output block in the background program of your strategy may output pulses to an electromechanical counter, for example, which works reliably only if the pulse-lengths lie within a specified range. If the background program is running rather slowly, because of a lot of higher priority task activity, it is possible for a logic 1 output to last a relatively long time before being reset at the next block update. (Remember that only *one* background program instruction need be executed every half-second to prevent the watchdog tripping.)

This variation in the pulse-lengths could cause miscounting or even damage to the counter, and so this type of control arrangement is not recommended.

There are obviously many alternative ways of implementing a control strategy, and distributing blocks and connections between the three User Tasks. You should always consider the possible effects the task scheduling and priorities have on the operation of the strategy, especially when digital signals are involved.



Chapter 10

ERROR MESSAGES & DIAGNOSTICS

In this chapter error conditions are dealt with in two parts: errors involving invalid Hand-Held Terminal key-presses, and instrument failure or other errors. Tables 10.1 and 10.2 summarise the symptoms and possible causes of these two types of error condition. More detailed information is given in the numbered text paragraphs after the tables.

Symptom on HHT	Possible Fault(s)	Para.
??CMD mode prompt not displayed and/or continuous 'beep'	Initialisation Error	1
??CMD or ??BCMD prompts repeated after parameter mnemonic entered	Illegal Parameter Mnemonic	2
Data characters ignored	Illegal Data Entry	3
Load Key (L+ or M-) ignored	Illegal Load Key	4
Data entry causes redisplay of original or truncated parameter value	Illegal Input to Read-Only Parameter	5
	Invalid or Out-of-Range Data	6
??BCL mode: cursor jumps back to source block address	Undefined Interconnection Address (Source)	7
	Invalid Connection Mnemonic (Source)	9
??BCL mode: cursor jumps back to start of destination block address as soon as entered	Undefined Interconnection Address (Destination)	7
	Illegal Block Loop Number	8

Table 10.1 . . . *Hand-Held Terminal Error Conditions*

Symptom on HHT	Possible Fault(s)	Para.
??BCL mode: cursor jumps back to start of destination block address when load key pressed (L+)	Invalid Connection Mnemonic (Destination)	9
??BCL mode: all key presses ignored (except W, Z, SP, and L1 or L2)	Program Write-Protect Active	10
??BCMD mode: FC parameter cannot be altered; original value redisplayed when L+ pressed	Program Write-Protect Active	10
??BCMD mode: cannot assign or re-assign a block to an address; all key presses ignored (except W and Z)	Program Write-Protect Active	10
??BCMD mode: control block ES and/or MD parameter bit-changes ignored	Connections to block's mode-select digital I/Ps may prevent writing to ES, MD. (See Ch. 7)	
??BCMD mode: cannot access MANS block (M1 or M2); XCON/RCON appears instead (W returns to mode prompt)	MANS block has been incorporated into control block (XCON or RCON) where parameters can be accessed	
??CMD mode: cannot alter II parameter; original value redisplayed when load key (L+) pressed	Program or E ² PROM Write-Protect Active	10
??CMD mode: FX parameter disabled; load key (L+) ignored for store or recall	Program Write-Protect Active	10
??CMD mode: FX parameter partially disabled; cannot store database to memory; 'FX ER' message displayed	E ² PROM Write-Protect Active	11

Table 10.1 (contd.) *Hand-Held Terminal Error Conditions*

ERROR MESSAGES & DIAGNOSTICS

Symptoms	Possible Fault(s)	Action
All displays blank	Power supply failure	Check supply
All displays blank except power-on LED(s); all comms disabled; pin 9 at 0V	Watchdog failure (hardware)	Replace unit
Unused decimal points flashing; GENP ST bit 11 set	Battery voltage low	Replace battery
Digital readout flashing; program halts; ??BCL Ln SC xy error message; GENP ST bits (3, 6, 7, and/or 8) set	Function block* sumcheck error in loop n	Re-enter params. in block at address xy
Digital readout flashing; GENP ST bits 6 or 7 set	Program not started	Execute program from ??BCL mode
ANIN ST bits 1 & 2 set	Open-circuit input >3 sec.	Apply input
ANIN ST bit 2 set	Open-circuit or out-of-range input	Apply suitable input
ANOP B3 malfunction	Loop 2 halted with Default Mode selected. This connects MANS M2 to ANOP B3, locking it	Run Loop 2 with MANS M2 installed as dummy
Front-panel M, A, and R mode keys disabled	Control block SM parameter active	Write 0 to SM
	Display mode active	Select a loop
	Control block mode-select digital I/P(s) high	Alter program if required (See Ch. 7)

Space for User's notes:

Table 10.2 *Instrument Failure Error Conditions*

*See para. 12

1 Initialisation Error

If the 8263 terminal plug is not pushed fully home in the instrument's front panel socket, or if it is connected before power-up, the terminal may not properly initialise and so will not display the command mode prompt (?? CMD). The 8263 may also generate a continuous 'beep' when this happens.

Unplugging then properly plugging-in the terminal to the *powered-up* instrument should initialise it successfully.

2 Illegal Parameter Mnemonic

If, in response to a mode prompt, a non-existent two-character parameter mnemonic is keyed in, the instrument rejects the illegal entry and repeats the mode prompt (?? CMD and ?? BCMD modes). This happens after the second character has been keyed in.

3 Illegal Data Entry

After a valid two-character parameter mnemonic has been successfully entered, the instrument expects to receive the correct number and type of data characters, according to the particular parameter's data format. It will also accept the terminal control characters Q, W, and Z.

All other characters are illegal, and are simply ignored until a valid entry is made. Then the flashing cursor steps on to the next character position, as normal.

(An example would be entering alpha characters A, B, C, etc. where decimal numbers are expected.)

4 Illegal Load Key

After the four data characters of the parameter have been successfully entered, the instrument expects to receive a positive or negative load key character (L+ or M-) appropriate to the parameter's data format before loading the data into memory. Terminal control characters Q and Z (but not W) will also be accepted.

All other characters are illegal, and are simply ignored until a valid entry is made.

(An example would be pressing the negative (M-) load key to load data into an ST parameter, which has the HHHH format and is therefore always *positive*.)

5 Illegal Input to Read-Only Parameter

Certain parameters are for monitoring purposes only and therefore have a *read-only* status. When these parameter mnemonics have been entered, the only characters that will be accepted are the terminal control characters W (to scroll) and Z (to return to mode prompt).

Any other character is illegal, and causes the display to clear and be refreshed with the parameter mnemonic and current value.

6 Invalid or Out-Of-Range Data

An error condition arises if you try to load a parameter with invalid or out-of-range data. In this case, when the load key is pressed, the instrument responds by refreshing the display with either the *original* value of the parameter, or with a value that has been *truncated* to be in-range.

(An example would be trying to load SL, currently at 30.00, with the value 99.99, when HS = 40.00. In this case SL is redisplayed with its new and truncated value of 40.00.)

7 Undefined Interconnection Address

(?? BCL mode) An error condition arises if you try to configure an interconnection involving an address that has no block assigned to it. The terminal response is slightly different according to whether the invalid address is in the *source* block or *destination* block.

Invalid Source Address. You can enter the invalid source block address, but after the connection mnemonic has been keyed in the flashing asterisk cursor moves back to the start of the address again (instead of jumping over to the right of the display). You cannot proceed until a valid (assigned) address is entered.

Invalid Destination Address. As soon as you enter the invalid destination block address the cursor jumps back to its first character, awaiting a valid entry.

8 Illegal Block Loop Number

(?? BCL mode) An error can arise when you are interconnecting blocks with different loop numbers (defined by their FC parameters). To do this, the *destination* block loop number must equal 'n' in the ??BCL Ln mode prompt. Errors always occur if you try to interconnect blocks with unassigned (zero) loop numbers, or with loop numbers both different from the mode prompt number 'n'.

When you enter the address of the incompatible *destination* block the cursor jumps back to its first character, and you cannot proceed until the incompatibilities have been removed.

NOTE. You should properly assign loop numbers to the FC parameters of all the required blocks (in ?? BCMD mode), *before* configuring any interconnections (in ?? BCL mode).

9 Invalid Connection Mnemonic

(?? BCL mode) An error condition arises if you try to configure an interconnection involving a non-existent or illegal block connection mnemonic. The terminal response is slightly different according to whether the invalid connection is in the *source* block or *destination* block.

Invalid Source Connection. After the invalid connection mnemonic has been keyed in the flashing asterisk cursor moves right back to the start of the block address (instead of jumping over to the right of the display). You cannot proceed until a valid connection mnemonic is entered.

(An example of an illegal source connection would be:

```

@11A
Ø1=ADD2
  
```

Here, the flashing asterisk cursor has returned to the start of the ADD2 address (Ø1) because 1A is an *incoming* not an *outgoing* connection; only 1B and SC are valid.)

Invalid Destination Connection. When you press the load key (L+), after keying-in the invalid connection, the cursor jumps back to the first character of the destination block address. To proceed, you must then re-enter the address and a valid connection mnemonic.

10 Program Write-Protect Active

In motherboards, switch 3 of switchbank 3 (SW3 as shown in Figure 10.1) is used for protecting the program in RAM.

When switch 3 is OFF (or plug 11 pins 2 and 3 are linked) you cannot create, delete, or edit a block interconnection, install blocks at addresses (assigned blocks or control blocks), write to II or an FC parameter, or use the FX (store/recall database) parameter. However, you can still write values to any other parameter.

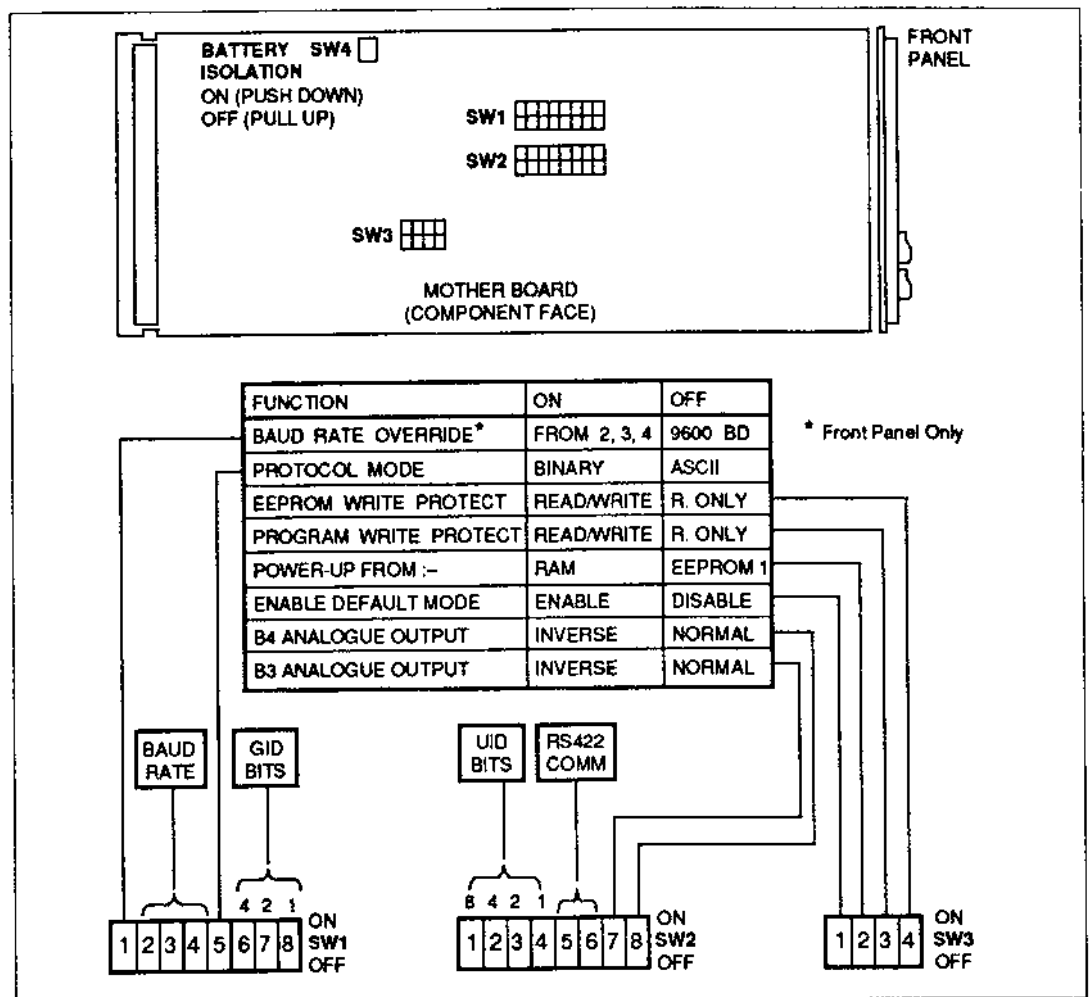

Figure 10.1 Motherboard Switch Functions

When Program write-protect is active, Hand-Held Terminal key presses that would normally alter the protected RAM contents are illegal and are either ignored, or the original parameter value is redisplayed on pressing the load key.

11 EEPROM Write-Protect Active

Switch 4 of switchbank 3 (SW3 as shown in Figure 10.1) is used for EEPROM write-protection. When switch 4 is OFF you cannot use the FX parameter (in ?? CMD mode) to store a database in any of the instrument's two EEPROM areas. The II parameter becomes read-only.

When EEPROM write-protect is active, pressing the L+ load key (after entering S1 or S2) is illegal and causes the message 'FX ER' to appear, instead of 'FX OK'. The *recall* function is unaffected, however.

12 Function Block Sumcheck Error

If a sumcheck error occurs in a function block, the control program containing the block usually halts, and the front panel digital readout display (for the relevant loop) starts to flash.

Also, for all blocks assigned to a given loop the ?? BCL mode prompt indicates the address of the faulty block in the message:

?? BCL In SC xy

where *n* is the relevant loop number, and *xy* the 2-character block address. For all *fixed* blocks (except Control and Manual Station blocks) the Command Mode SC parameter indicates addresses of faulty blocks.

NOTE. Sumcheck failures in blocks without FC parameters, namely ANIN, AOCB, DGIN, DOCB, and CONS, do not necessarily halt the program. Therefore you should connect up their SC digital outputs (or the GENP block CS output) to trigger any required action in the event of a sumcheck failure. (Figure 7.2 in Chapter 7 shows an example of this.)

A sumcheck failure in any block always sets ST bit 3 of the failed block, and also (for fixed blocks) ST bit 8 of the GENP block (fixed block sumcheck error). If the control program is halted, the appropriate bit (5, 6, or 7) in GENP ST also sets to indicate which loop is affected. Bits 0, 1, and 2 of GENP ST indicate the loop in which a sumcheck error has occurred.

When the failed block has been found, inspect its parameters (in ?? BCMD mode) and re-enter any corrupted data.

Chapter 11

SPECIFICATIONS

Figure 11.1 shows a hardware block schematic for the 6370/80 series of Intelligent Loop Processors. Figure 11.2 (page 11.15) shows a block schematic of the I/O structure and zero volts.

Analogue Inputs (ANIN Blocks)

Number of Channels

4 (6370/80) or 8 (6372/82) non-isolated inputs.

6350/60 Configuration: 3 direct (1 - 5V) non-isolated inputs, or 3 direct (0 - 10V) non-isolated inputs

Channel Functions

6370/72/80/82: User configurable.

6350/60 Configuration: Ch1 = Process Variable input, Ch2 = Remote Setpoint/ Ratio input, Ch3 = Setpoint Trim/ Track/ Measured Power input

Input Signal Levels

6370/72/80/82: 0 - 10V or 1 - 5V range (software selectable), with open-circuit detection. Out-of-range detection, 0 - 10V range: $< -0.75\text{V}$; 1 - 5V range: $< 0.6\text{V}$. (1 - 5V typically derived from 4 - 20mA across 250 Ω burden resistor).

6350/60 Configuration: Direct inputs are 0 - 10V or 1 - 5V range. (1 - 5V typically derived from 4 - 20mA across 250 Ω burden resistor).

Resolution

12 bit binary ADC (0 - 10V: 0.025%; 1 - 5V: 0.03%) hardware applied to inputs.

15 bit binary representation obtained after digital filtering and signal averaging giving resolution of 1 digit in ± 9999 .

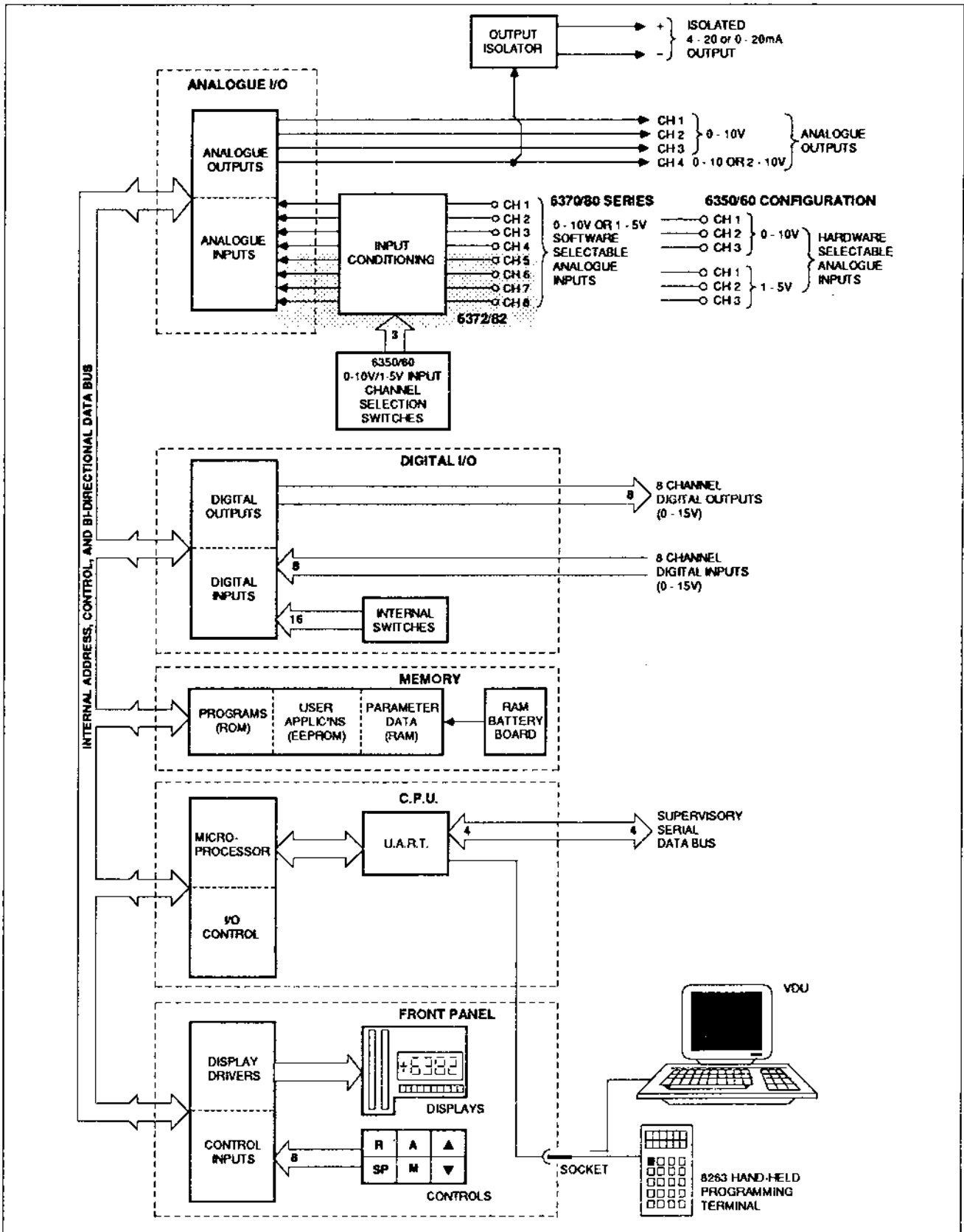

Figure 11.1 Intelligent Loop Processor Hardware Block Schematic

SPECIFICATIONS

Accuracy

±1 LSB (typical) over 0 - 50°C range for hardware.
±1 digit of reading for 0 - 4000 range,
±2 digits of reading for 0 - 8000 range,
±3 digits of reading for 0 - 9999 range, after input filtering.

Sampling Rate

ADC samples 1 channel every 9ms so that each channel is sampled once every 72ms (6372/82), or once every 36ms (6370/80).

Input Impedance

1 MΩ pull-down to -1.5V all channels (0 - 10V or 1 - 5V).

Input Signal Processing

Linear (normal or inverse).
Normalised square root.
Type J, K, T, S, R, E, B thermocouples.
Platinum resistance thermometers.
Five user-specified linearisation functions.

Input Filter Range

0.04 to 60.0 seconds (first order).

Analogue Outputs (ANOP Blocks)

Number of Channels

4 direct non-isolated outputs with 1 (channel 4, i.e. ANOP block B4) available as an isolated output.

Channel Functions

6370/72/80/82: User configurable.
6350/60 Configuration: Ch1 = 3-Term Control O/P, Ch2 = Process Variable O/P, Ch3 = Setpoint O/P or Error, Ch4: tracks Ch1 but rescaled to 2-10V; also drives 4-20mA isolated output.

Output Signal Levels

6350/60 Configuration: Direct outputs 0 - 10V range. Isolated output 4-20mA, capable of driving into 750Ω load.
6370/72/80/82: Direct outputs 0-10V range.
Ch4: 0-10V or 2-10V software selectable. Isolated output.
0-20mA or 4-20mA driven from Ch4 only, capable of driving into 750Ω load.

Output Circuit Type

Medium-term analogue sample-and-hold circuits preceded by DAC.

Output Resolution

12 bit binary (.025%) giving minimum analogue voltage steps of 2.5mV.

0 - 10V Output Accuracy

± 1 LSB (typical) over 0 - 50°C range.

Isolated Output Accuracy

$\pm 0.5\%$ of full scale.

Sample & Hold

DAC updates 1 channel every 9ms. Each channel is updated once per 36ms (50/60/70/80), or 72ms (72/82).

Output Drift Rate Under Watchdog Failure Conditions

0.5mV/sec maximum, equivalent to 1% of full scale in 3 minutes.

Output Drive Capability

± 5 mA for direct voltage outputs.

Isolation Voltage

± 50 V minimum with respect to system ground.

Digital Inputs (8-Way DGIN Block)**Number of Inputs**

8 external non-isolated inputs.

Input Functions

6370/72/80/82: All are user configurable.

6350/60 *Configuration*: I/Ps 1 - 4 = UID binary address, I/P5 = computer enable, I/P6 = Remote Setpoint/Ratio enable, I/P7 = Track enable, I/P8 = NOT-Hold enable.

Input Voltage Levels

15V nominal (threshold range 8 - 15V) = logic 1.

0V nominal (threshold range 0 - 2.5V) = logic zero.

Input Impedance

Inputs <10V: 100k Ω , with 100k Ω pull-down to 0V.

Inputs >10V: 100k Ω via diode to 5V.

SPECIFICATIONS

Bit Inversion

Exclusive OR mask allows individual bits to be inverted for use within programs (not 6350/60).

Digital Outputs (8-Way DGOP Block)

Number of Outputs

8 external non-isolated outputs plus Watchdog.

Output Function

6370/72/80/82: All are user configurable.

6350/60 Configuration: O/P1 = NOT-High Alarm, O/P2 = NOT-Low Alarm, O/P3 = NOT-Hardware alarm, O/P4 = NOT-Battery voltage low, O/P5 = NOT-Remote Auto/NOT-Ratio status, O/P6 = NOT-[Hold + Manual] status, O/P7 = User logic bit 1, O/P8 = User logic bit 2.

Output Voltage Levels

15V \pm 0.7V = logic 1; 0V -0 +0.4V = logic zero.

Output Drive Capability

Logic 1: 2.2k Ω open-collector pull-up to +15V supply rail, Watchdog 1k Ω open-collector pull-up to +15V.

Logic 0: sinks up to 16mA via 68 Ω from external load.

Logic drive can be supplied externally (15V max.).

Write Protection

Write-protect mask prevents individual bits being changed via the serial links.

Control Block (XPID)

Setpoint

Range, Limits, Rate Limits, low to high: -9999 to +9999

Alarms, Absolute PV, low to high: -9999 to +9999, with hysteresis of 0.5% of Process Variable span.

Alarms, Deviation, low to high: 0 to 9999, with hysteresis of 0.5% of Setpoint span

3-Term (PID) Control

Proportional Band range: (6370/72/80/82): 0 to 999.9%; (6350/60): 0 = on/off control action (integral time constant generates % hysteresis level above setpoint).

Integral & Derivative Time Constants Ranges:

(6350/60 emulation): 0.04 to 99.99 secs. or 0.01 to 99.99 mins (0 = off).

(6370/72/80/82): 0.1 to 99.99 secs. or 0.01 to 99.99 mins (0 = off).

Feed-forward term: -99.99% to +99.99%

Feed-back term: 0 - 99.99%

Control output range: 0 - 99.99% (with reverse action option)

PID Algorithm Sampling Period: 100ms to 11.4s, set by instrument.

Control Block (XCON)**Setpoint**

(as for XPID block)

3-Term (PID) Control

(as for XPID block)

Manual Station

(as for MANS block).

Ratio Control Block (RPID)**Setpoint**

(as for XPID block)

3-Term (PID) Control

(as for XPID block)

Ratio

Ratio setting range, low to high: 0 to 9999 with Inverse Ratio option.

Ratio Trim range, low to high: -9999 to +9999.

Ratio Bias: same range as setpoint.

Ratio Control Block (RCON)**Setpoint**

(as for XPID block)

3-Term (PID) Control

(as for XPID block)

Manual Station

(as for MANS block)

SPECIFICATIONS

Ratio

(as for RPID block).

Manual Station Block (MANS)

Output Range

0 to 99.99%.

Limits

High, low, rate: 0 to 99.99%.

Polarity

Inverse output mode (via Analogue Output block, software/switch selectable).

Raise/Lower rate in Manual

0 - 99.99% in 10s, accelerating action.

General Purpose Block (GENP)

Status Indications

Power fail, battery, common block sumcheck errors, loop repeat time(s)
(range: 0.1 to 999.9 sec).

Lead/Lag Block (LLAG)

(6372/82 only)

Filter Type

Lead/lag

Filter Gain Range

-99.99 to +99.99.

Lead & Lag Time Constants Range

(0 = off) 0.04 to 99.99 seconds or 0.01 to 99.99 minutes.

Feed-Forward/Output Bias

-99.99% to +99.99%.

Deadtime Block (DTIM)

(6372/82 only)

Delay Range

100ms to 2.7 hours

Delay Buffer

80 segments, with linear interpolation between segments. (Input first-order filtered.)

Totalisation Block (TOTL)

(6372/82 only)

Type

Integrating flow totaliser — $\sum[\text{flow signal}] * \Delta T$ — where ΔT is the loop scan time.

Flow Total Range

0 to 9999, with automatic roll-over.

Totalisation Input Timescales

/second, /minute, /hour, or /day.

Flow Scaling Factor

0.0001 to 9999

Display Block (DISP)

(6372/82 only)

In Display Mode, the front panel displays are assignable to any analogue or digital variable in a control strategy.

Indication

Both loop LEDs lit.

Displays Assignable

6372/82 : Digital display, -9999 to +9999 (unranged), decimal point. Horizontal output bargraph, ranged, 0 to 100%.

6372 only: Deviation bargraph, ranged, 0 to $\pm 8\%$ displayed.

6382 only: Left- & Right-hand vertical bargraphs, ranged, 0 to 100%.

SPECIFICATIONS

Alarm Block (ALRM)

Number of Alarms

2 high and 2 low alarms.

Alarm Types

User-configurable for Absolute, Deviation, or Rate alarms.

Alarm Ranges

Deviation: Low, High, 0 to 9999

Absolute: Low, High, -9999 to +9999

Rate: Same range as PV, in engineering units/sec

(All with programmable common decimal point position.)

Characteriser Block (CHAR)

(6372/82 only)

Type

16-breakpoint user-programmable characterisation function, with linear interpolation between data points

X-Coordinates (Input) Range

-9999 to +9999, monotonically increasing.

Y-Coordinates (Output) Range

-9999 to +9999.

Assigned Blocks

The following is a selection of the assigned blocks presently available from TCS. New ones are being introduced on a continuing basis.

Maths Blocks

Scale factor range: 0 to ± 9999

Analogue value range: 0 to $\pm 10^{38}$ within and between blocks (rounded to ± 9999 for front-panel displays).

ADD2	— Add	ROOT	— Square root
SUBT	— Subtract	EXP	— Exponential
MPLY	— Multiply	ABS	— Absolute value
DIVD	— Divide	NEGT	— Inverse (negation)
AVG2	— Average	NLOG	— Natural logarithm
		EXPN	— Y^X
SIN	— Sine	INT	— Integer
COS	— Cosine	RANG	— Range & Limit
TAN	— Tangent		

Constants Blocks

4 constants, ranges: -9999 to +9999.

CONS — read-only constants (within control strategy)

SAMP — conditional read/write constants.

Logic Blocks

AND2	— ANDs two inputs
OR2	— ORs two inputs
XOR2	— Exclusive-ORs two inputs
AND4	— ANDs four inputs
OR4	— ORs four inputs
NOT	— NOTs one input
LTCH	— 'Set/reset' latch

Comparator Blocks

GT	— Greater than
LT	— Less than
EU	— Equal to

Selector Blocks

HSL2	— High Select
LSL2	— Low Select
MSL3	— Median Select
SLCT	— Select. (Digital input state outputs one of two analogue inputs.)

Time Blocks

RATE	— Rate Limit
RAMP	— Ramp
TIME	— Timer
PGNT	— Pulse Generator

SPECIFICATIONS

Count Blocks

PCNT — Pulse Counter

Max/Min Blocks

PEAK — Peak Detect (Max/Min)

Communications Blocks

AICB — Eight-channel Pseudo Analogue Input

AOCB — Eight-channel Pseudo Analogue Output

DICB — Single-channel Pseudo Digital Input

DOCB — Single-channel Pseudo Digital Output

Timing Accuracy — All Timer Blocks

Timebase Accuracy (Crystal)

±0.05%

Communications Blocks (AICB, AOCB, DICB, DOCB)

Number of Communications Channels

2 serial data links, full duplex hardware capability, half duplex software implemented.

Front-Panel (8263 Hand-Held Terminal) Data Link

- Transmission Standard: 2-wire RS232/V24 (±12V nominal).
- Data Rate: self-setting to match instrument, from 300, 600, 1200, 2400, 3600, 4800, or 9600 baud.
- Character Length: 10 bits made up of 1 start + 7 data + 1 parity (even) + 1 stop.

Rear Connector Multi-Drop (Supervisory Computer) Data Link

- Transmission Standard: 4-wire RS422 (0-5V).
- Line Impedance: 120 - 240Ω twisted pair.
- Line Length: 4000ft (1220m) max., at 9600 baud.
- Number of Units per Line: 16, but nesting of buffers provides max. total of 128 addresses.
- Data Rate: Selectable from 110, 300, 600, 1200, 2400, 3600, 4800, or 9600, baud.

- Character Length:
- ASCII mode 110 baud 11 bits made up of 1 start + 7 data + 1 parity (even) + 2 stop.
300 - 9600 baud 10 bits made up of 1 start + 7 data + 1 parity (even) + 1 stop.
 - Binary mode 110 baud 12 bits made up of 1 start + 8 data + 1 parity (even) + 2 stop.
300 to 9600 baud 11 bits made up of 1 start + 8 data + 1 parity (even) + 1 stop.

Operator Front Panel Displays

Refer to Chapter 2 for full details of front panel features.)

All instruments:

Digital Readout

Configurable 4-digit, orange LED display with sign (\pm) and decimal point that can be programmed to show 4, 3, 2, 1, or zero decimal places. (Assignable to any variable in Display Mode via the DISP block.)

Horizontal Bargraph

Configurable horizontal yellow LED bargraph with 10 segments to indicate 0-100% output in 10% steps. (Assignable to any variable in Display Mode via the DISP block.)

6370/2 only:

Deviation Bargraphs

Two red 8-segment LED bargraphs for positive and negative error in 1% steps. Green LED in centre of bargraphs indicates power-on and zero error. (Assignable to any variable in Display Mode via the DISP block.)

6380/2 instruments only:

Vertical Bargraphs

Two configurable 101-segment red LED bargraph displays for Process Variable and Setpoint, from 0 - 100% with resolution of 1%. Lowest segment of each bargraph indicates power-on and zero reading. (Assignable to any variables in Display Mode via the DISP block.)

SPECIFICATIONS

6372/82 only:

Loop Indicators

Two yellow rectangular LEDs to indicate loop 1 or loop 2 being displayed on front panel. Both lit indicates Display Mode. Flashing LED indicates Track or Hold control mode for relevant loop.

6370/80 only:

Control Loop Mode Indicators

Two yellow rectangular LEDs to indicate Track or Hold control loop mode active.

Operator Front Panel Controls

Control Mode Selectors

3 momentary-action illuminated push-buttons:

- Manual (M) with integral yellow LED
- Local Auto (A) with integral green LED
- Remote Auto or Ratio (R) with integral green LED.

Function Selectors

2 momentary-action non-illuminated push-buttons:

- 'Raise' (Δ in 1-loop, or Δ^2 in 2-loop instruments) *either* selects PID loop 2 if operated alone (2-loop instruments), *or* increments the 3-term output with (M) pressed, *or* increments the setpoint or ratio setting with (SP) pressed.
- 'Lower' (∇ in 1-loop, or ∇_1 in 2-loop instruments) *either* selects PID loop 1 if operated alone (2-loop instruments), *or* decrements the 3-term output or setpoint/ratio setting as above. Pressing *both* accesses Display Mode.

Display Selector

1 momentary-action non-illuminated push-button (SP) causing the digital readout to display the current setpoint (SL, or RS in RATIO mode) whilst pressed.

3-Term Control Output Display

Pressing either the Manual (M), Auto (A), or Remote (R) button causes the digital readout to display the current 3-term control output level as a 4-digit value in the range 0 to 99.99%.

Hand-held Terminal Socket

Accepts the 8263 Hand-Held Terminal, or computer/VDU terminal, for RS232 configuration of the instruments. Alternatively (but not simultaneously), the rear-panel RS422 data link can be used with a supervisory computer.

Power Supplies

Input Voltage

(May be unsmoothed full-wave rectified AC).
20 - 30V DC recommended operating range.
19 - 35V DC absolute maximum input limits.

Input Current

At 24V DC typical:
330mA without Hand-Held Terminal
335mA with Hand-Held Terminal.

Input Fuse Rating

1A.

Internal Supply Rails

Nominal Voltage	Voltage Tolerance	Power Limit
+15V analogue	±0.7V	Total output power limited to 25W
+15V digital	±0.7V	
+15V logic O/P	±0.7V	
+5V	±10mV	
-15V analogue	±0.7V	

Power Failure Detect Threshold

When input voltage falls below $16.5 \pm 2V$.

Power Limiting

When 25W output is exceeded, 'trip-and-try again' circuitry is activated.

Remote Transmitter Supply

26V $\pm 1.5V$ at 4mA output. 30V $\pm 0.5V$ at 20mA output. $\pm 50V$ minimum isolation with respect to system ground.

Memory Standby Battery

Lithium type.
3.0V nominal output at 160mAh.
8 - 10 year shelf life typical.
5 year life typical on continuous standby.
20 minute holdup time minimum with battery board removed.

RFI Susceptibility

Conforms to IEC 801-3 and CEGB DN5.

SPECIFICATIONS

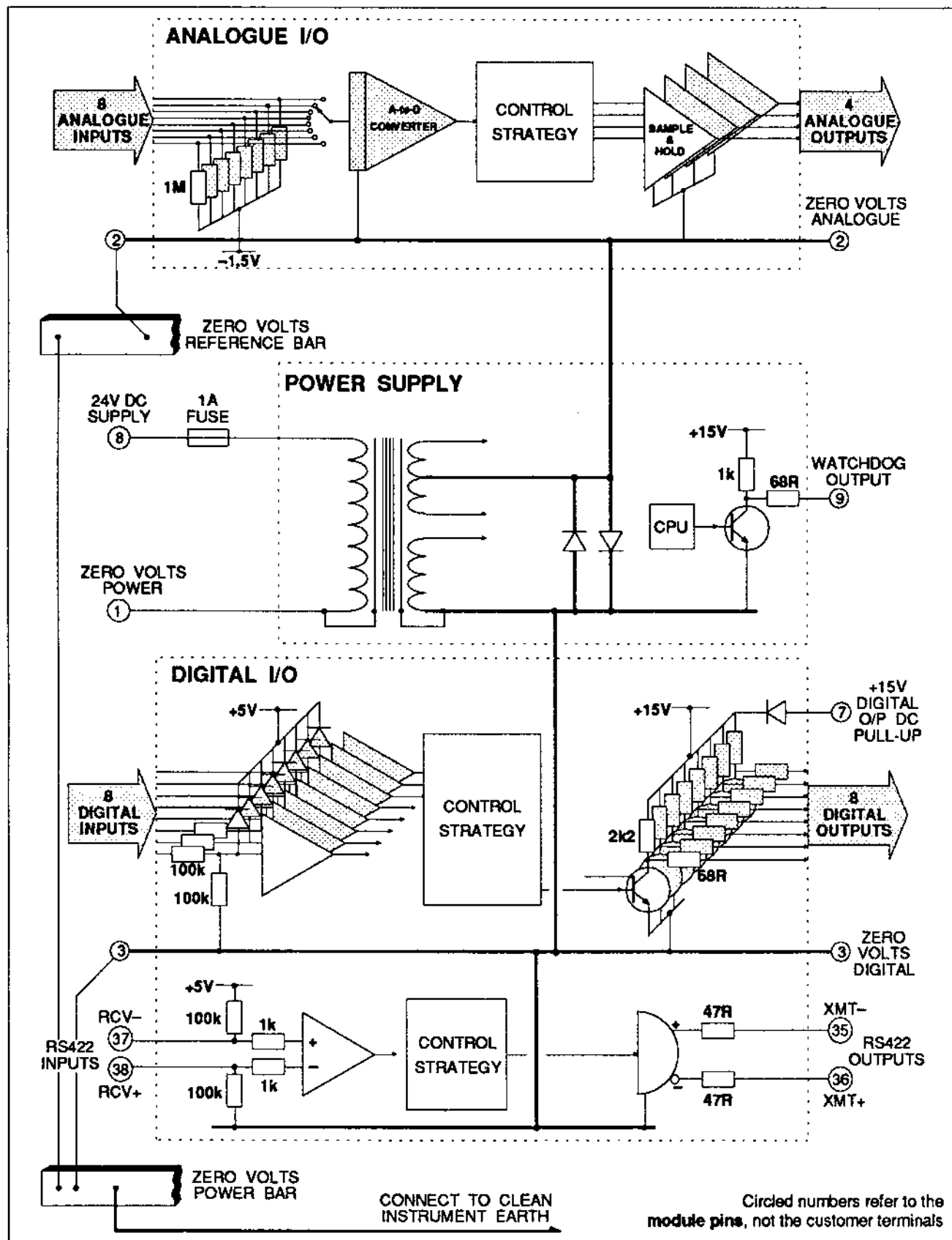

Figure 11.2 6370/80 Series I/O & Zero Volts Block Schematic

System Grounding

To obtain optimum performance the zero volt system should be connected as shown schematically in Figure 11.2.

Zero Volts Analogue. Provides reference connections for all precision analogue measurements and is common to all modules in the system. Minute current-flows are normal in the zero volt analogue circuits, but any *additional* injected currents may reduce measurement and control accuracy.

Zero Volts Digital. Provides reference and current return connections for all digital signals including RS422 communications.

Zero Volts Power. Provides the return path for the 24V DC supply. The power supply circuit should be connected to the zero volts power after taking into account the system polarity.

The instrument earth connection can be the mains safety earth if this is noise-free. Alternatively, an independent low impedance earth source via a suitable conductor driven into the soil may be used.

⚠ WARNING: Improper use of the above connections may degrade or damage the system.

Physical Specification

Mechanical

Housing Supplied: 72mm wide metal housings fitted with front panel fascias and catch handles for module retention.

Mounting: 7930 DIN sleeves, or 7950 Universal Packaging System (recommended).

(Alternatively, can be fitted into other suppliers' housings, on application).

Dimensions (mm): 72W × 142H × 300D.

Weight: 1.16kg (without sleeve).

Environmental

Operating Temperature: 0 to +50 °C.

Storage Temperature: -20 to +55 °C.

Relative Humidity: 5 to 90 % non-condensing.

Ventilation: rack or bin mounted instruments must have at least a 1U gap above and below the case for proper ventilation. Sleeve mounted instruments should be mounted as specified in the relevant sleeve data sheet.

SPECIFICATIONS

8263 Hand-Held Terminal

Physical

Dimensions (mm): 82W × 156H × 35D.

Weight: 250g.

Case Material: black moulded ABS

Display: 2 × 16 characters, 7 × 5 dot matrix LCD, with contrast/viewing angle control

Keyboard: 40 keys (5 columns at 12mm pitch × 8 rows at 10mm pitch)

Electrical

Interface: serial ASCII (see Communications specification above for details)

Power: 5 ± 0.25V at 20mA from host instrument (0.1W)

Cable: helical telephone style, 2m stretched length

Plug: 7-way sub-miniature connector and guides (refer to Chapter 3 for wiring details)

Environmental

Storage temperature: -20 to 55°C

Operating temperature: 0 to 50°C.

Ordering Codes

63XX/CASE: 63XX instrument with case.

63XX/DIN: 63XX instrument without case. *Available only when ordered with a 7930 DIN sleeve.*

8263: 8263 Hand-Held Terminal with integral cable/plug.

Example: 6382/CASE.

Warranty & After-Sales Service

TCS Ltd will normally repair/replace an instrument which is found to be defective within 24 months of delivery. *Full details of the Warranty are given in our Terms & Conditions, available from the Sales Office.*

TCS Ltd offers a comprehensive range of services including Training, Systems Support, Field Service/Commissioning, Custom Linearisation, and Repair/Recalibration. For further information please contact our Customer Services Division, tel. Worthing (0903) 205277.

Documentation & Software Issue Definition

Issue X/Y denotes documentation that refers to an instrument with software issue number X (all releases covered), at edition Y (Y is a letter). E.g. Issue 3/D refers to software Issue 3 and manual edition D (the fourth).

Manuals start at edition A. New editions of the manual are produced to correct typographic or factual errors or omissions, or to update the manual with the latest software *release* information. The new edition letter increments to the next letter in alphabetical order.

When a new *issue* of software appears (not just a new release of the existing issue), the related documentation has the new issue number and starts at edition A again.

Appendix A

637X/8X MOD PIN No.	TA637X/8X TERMINAL NUMBER	637X/8X INSTRUMENT FUNCTION	6350/60 INSTRUMENT FUNCTION
1	14	0 VOLTS SUPPLY	0 VOLTS SUPPLY
2	16,17,18,19	0 VOLTS ANALOGUE	0 VOLTS ANALOGUE
3	43	0 VOLTS DIGITAL	0 VOLTS DIGITAL
7	28	DIG OUT. DC. P/UP	DIG OUT. DC. P/UP
8	15	DC SUPPLY I/P	DC SUPPLY I/P
9	13	WATCH DOG OUT 1	WATCH DOG OUT 1
10	1	AN1. IN	PV. IN (1 - 5V)
11	2	AN2. IN	REM. SP. IN (1 - 5V)
12	3	AN3. IN	SP. TRIM IN (1 - 5V)
13	4	AN4. IN	PV. IN (0 - 10V)
14	31	AN5. IN *	REM. SP. IN (0 - 10V)
15	32	AN6. IN *	SP. TRIM IN (0 - 10V)
16	20	DIG1. OUT	HI. ALM. OUT (0)
17	21	DIG2. OUT	LO. ALM. OUT (0)
18	22	DIG3. OUT	HW. ALM. OUT (0)
19	23	DIG4. OUT	BAT. LOW OUT (0)
20	24	DIG5. OUT	REM. AUT. OUT (0)
21	25	DIG6. OUT	HLD + MAN. OUT (0)
22	26	DIG7. OUT	BIT 1 OUT (1)
23	27	DIG8. OUT	BIT 2 OUT (1)
24	5	DIG1. IN	ADD1 IN (1)
25	6	DIG2. IN	ADD2 IN (1)
26	7	DIG3. IN	ADD4 IN (1)
27	8	DIG4. IN	ADD8 IN (1)
28	9	DIG5. IN	COMP. EN. IN (1)
29	10	DIG6. IN	REM. SP. EN. IN (1)
30	11	DIG7. IN	TRACK EN. IN (1)
31	12	DIG8. IN	HOLD EN. IN (0)
32	37	AN1. OUT	3T OUT (0 - 10V)
33	38	AN2. OUT	PV OUT
34	39	AN3. OUT	SP/DEV OUT
35	29	XMT. OUT (-) RS422	XMT. OUT (-) RS422
36	30	XMT. OUT (+) RS422	XMT. OUT (+) RS422
37	44	RCV. IN (-) RS422	RCV. IN (-) RS422
38	45	RCV. IN (+) RS422	RCV. IN (+) RS422
39	40	AN4. OUT	3T OUT (2 - 10V)
40	35	TX. SUPPLY (-)	TX. SUPPLY (-)
41	36	TX. SUPPLY (+)	TX. SUPPLY (+)
43	41	OS4 ISOL (-)	3T. OUT ISOL 4 - 20mA (-)
45	42	OS4 ISOL (+)	3T. OUT ISOL 4 - 20mA (+)
47	33	AN7. IN *	
48	34	AN8. IN *	
	A	DC SUPP1 IN (20 - 30V)	DC SUPP1 IN (20 - 30V)
	B	24V SUPP OUT	24V SUPP OUT
	C	DC SUPP2 IN (20 - 30V)	DC SUPP2 IN (20 - 30V)

*Not available
with the 6370/80
models

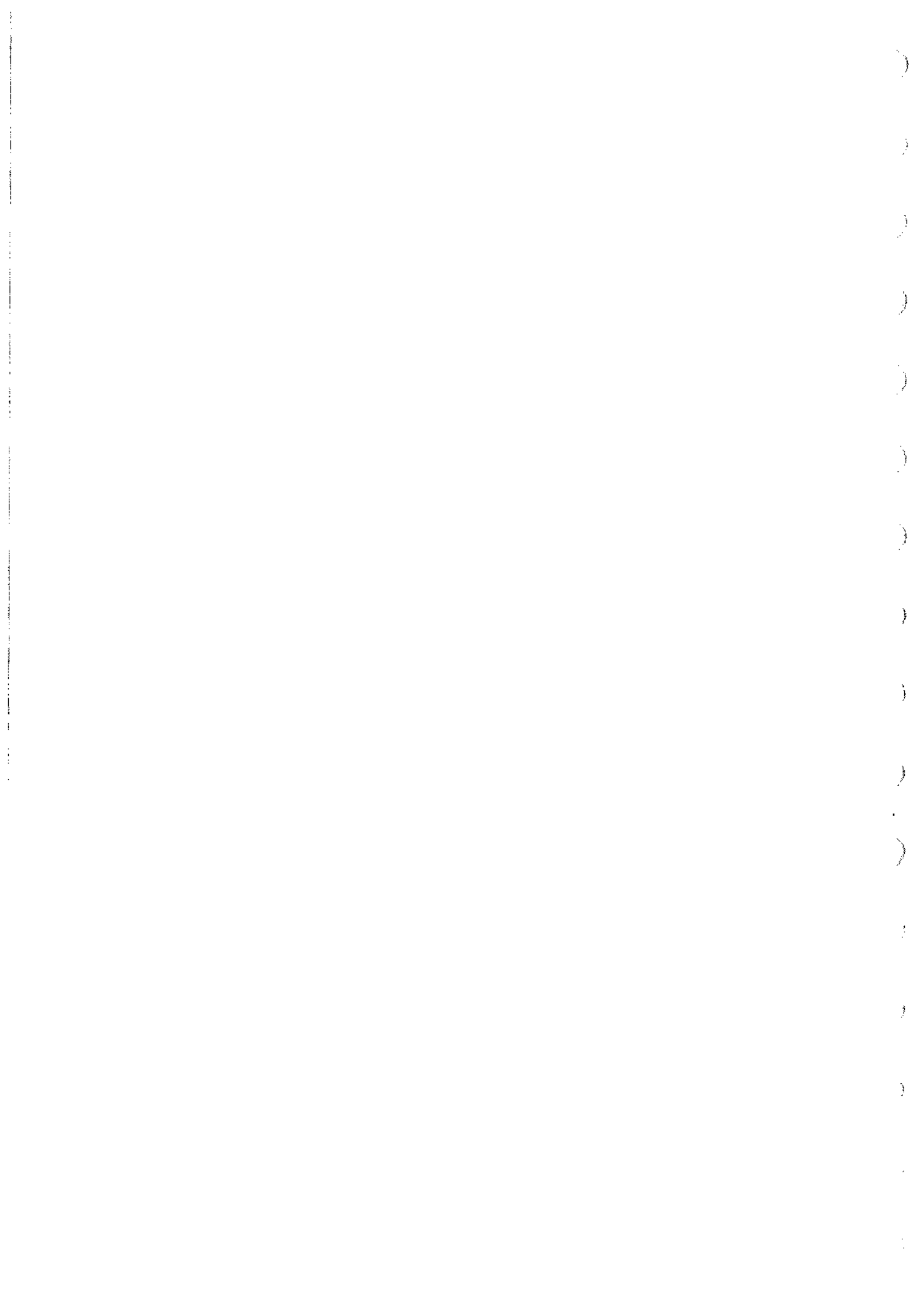

INDEX

& key, 3.25
' symbol, 3.30
> symbol, 3.9, 3.30
??BCL, 3.19
??BCMD, 3.12
??CMD, 3.9, 6.1

1B (display block), 4.114
1H & 1L (display block), 4.112
1K (pulse counter block), 5.57
1K (pulse generator block), 5.53
1K & 2K (maths arithmetic blocks), 5.7
1K - 4K (constants blocks), 5.20
1K - 4K (SAMP block), 5.22
1T & 2T (lead/lag block), 4.97
2B (display block), 4.114
2H & 2L (display block), 4.114
3-term control algorithm, 7.10
3B (display block), 4.115
3H & 3L (display block), 4.114
3T (XCON control block), 4.64
3T (XPID control block), 4.47
6350/60 emulation, 1.3
6370 front panel, 2.2
6370/80 range, 1.1
6372 front panels, 2.3
6380 front panel, 2.4
6382 front panel, 2.5
7930 sleeve, 1.3
7950 Universal Packaging System, 1.3, 1.6
8263 Hand-Held Terminal, 1.5, 3.1

8263 Hand-Held Terminal errors, *10.1*
8263 Hand-Held Terminal specifications, *11.16*
8750 power supply, *1.6*

ABS block, *5.11*
ADD2 block, *5.5*
address, undefined, *10.5*
AI (characteriser block), *4.124*
AI (analogue input block), *4.13*
AICB block, *5.63*
alarm block, *4.116*
alarm block specifications, *11.9*
alarm indication, *2.6*
alarm settings (6360), *2.9*
ALRM block, *4.116*
analogue I/O circuit block, *1.9*
analogue input block, *4.7*
analogue inputs specifications, *11.1*
analogue output block, *4.14*
analogue outputs specifications, *11.3*
AND2 block, *5.23*
AND4 block, *R.23*
ANIN block, *4.7*
ANOP block, *4.14*
AO (analogue output block), *4.19*
AO (pseudo analogue output block), *5.7*
AOCB block, *5.68*
arrow symbol, *3.23*
ASCII codes, Hand-Held Terminal, *3.5*
ASCII mode communications protocol, *8.4*
assigned block connection diagrams key, *5.3*
assigned block installation, *3.12*
assigned block names, *5.3*
assigned blocks, *1.2, 5.1*
assigned blocks specifications, *11.10*
auto/manual control loop example, *7.7*
auto fall-back mode, *7.1*
auto mode, *7.1*
auto mode select button, *2.8*
auto-prioritisation, *3.25*
AV (analogue input block), *4.13*

AV (pseudo analogue input block), 5.67
average block, 5.5
AVG2 block, 5.5

backspace/refresh key, 3.27
balancing, 7.18
bargraph flashing, 2.6
battery, 2.5
battery board, 1.9
battery failure, 1.8
battery voltage, 1.9
baud rate setting, Hand-Held Terminal, 3.6
binary mode communications protocol, 8.6
block command mode, 3.12
block connection mode, 3.19
block execution order, 3.21, 3.25
block installation, 3.12
block interconnection configuration, 3.20
block interconnection editing, 3.21
block interconnection scrolling, 3.28
block loop number, illegal, 10.6
block parameter access, 3.14, 3.16
blocks/functions available, 1.2
burden resistors, 1.7

C key, 3.27
CGP option, 1.6
CHAR block, 4.122
characteriser block, 4.122
characteriser block specifications, 11.9
CI (command mode), 6.6
command mode, 3.9
command mode parameters, 6.1
command mode prompt, 3.7
communications, 1.3
communications blocks specifications, 11.9
communications protocol, 8.3
communications, serial data, 8.2
computer supervision of instruments, 8.1
connection mnemonic, invalid, 10.6
CONS block, 5.9

control algorithm, 7.10
control block (XCON), 4.59
control block (XCON) specifications, 11.6
control block (XPID), 4.37
control block (XPID) specifications, 11.5
control block assignment, 3.14, 4.2
control loop operating modes, 7.1
control output source, 7.2
controller output, 2.6
controller output adjustment, 2.9
COS block, 5.8
CPU, 1.5
CPU circuit block, 1.8

data format symbols, 4.6
DD (display block), 4.115
deadtime block, 4.99
deadtime block specifications, 11.8
decimal point display, 3.17
decimal point position, 3.31
decimal points flashing, 2.5
default mode, 7.8
DEL key, 3.24
deleting interconnections, 3.24
destination address, invalid, 10.5
destination of block interconnection, 3.21
deviation alarms, 2.2
deviation bargraphs, 2.2
DGIN block, 4.21
DGOP block, 4.31
diagnostics & error messages, 10.1
diagnostics & reliability, 1.3
DICB block, 5.71
digital I/O circuit block, 1.9
digital input block, 4.21
digital inputs, 1.5
digital inputs specifications, 11.4
digital inputs to control strategy, 2.7
digital output block, 4.26
digital outputs, 1.5
digital outputs specifications, 11.5

digital readout, 2.4
digital readout flashing, 2.5
DIN-compatible sleeve, 1.3
DISP block, 2.3, 2.5, 4.109
display block, 4.109
display block specifications, 11.8
display mode, 2.3, 2.6, 2.7, 2.9
displays specifications, front panel, 11.12
DIVD block, 5.5
divide block, 5.5
DOCB block, 5.75
documentation & software issue definition, 11.18
DS (digital input block), 4.25
DS (digital output block), 4.29
DS (pseudo digital input block), 5.74
DS (pseudo digital output block), 5.77
DT (deadtime block), 4.102
DTIM block, 4.99

E1, E2 EEPROM (command mode), 6.7
E key, 3.25
EB (equal block), 5.32
editing assigned block name, 3.27
editing source/destination of interconnection, 3.28
EEPROM area, 1.8
EEPROM storage of databases, 6.6
EEPROM write-protect active, 10.8
emulation capability, 1.3
emulation of instruments, 8.6
enquiry polling, 8.10
EP (pulse counter block), 5.58
equal block, 5.30
ER (XPID control block), 4.47
error conditions, Hand-Held Terminal, 3.32
error messages & diagnostics, 10.1
errors, 1.3, 2.2
ES (XPID control block), 4.52
escape (to current mode prompt), 3.29
ET (timer block), 5.49
EU block, 5.30
execution of control program, 3.25

EXP block, 5.11
EXPN block, 5.13
exponent block, R.13
exponential block, 5.11

FB (XPID control block), 4.51
FC function control register, 4.19
FC parameter, 3.21, 10.6
FC parameter, blocks without, 10.8
FC parameter, blocks without, 10.8
feedback, 7.16
FF (XPID control block), 4.51
FF (lead/lag block), 4.98
FI (lead/lag block), 4.98
Filter (LLAG) block, 4.94
fixed block connection diagrams, key, 4.3
fixed function blocks, 1.2, 4.1
forced auto mode, 2.8
forced manual mode, 7.1
formats of parameters, 3.30
front panel, 1.5, 2.1
front panel controls specifications, 11.13
front panel daughter board, 1.7
front panel displays specifications, 11.12
front panel mode indication, 7.3
FS (totalisation block), 4.107
FT (totalisation block), 4.108
function block sumcheck error, 10.8
functional descriptions of circuits, 1.7
fuse, 1.11
FX (command mode), 6.6
FX ER message, 6.6
FX OK message, 6.6
FX parameter, 10.8

general purpose block (GENP), 4.85
general purpose block specifications, 11.7
GENP block, 2.7, 4.85
GID, 8.2
GID and INO, 8.7
greater-than block, 5.27
GT block, 5.27

- H1 & L1 (alarm block), 4.119
- H2 & L2 (alarm block), 4.120
- HA & LA (XPID control block), 4.45
- halted program, 3.25
- Hand-Held Terminal, 3.1
- Hand-Held Terminal cable & plug, 3.2
- Hand-Held Terminal display, 3.3
- Hand-Held Terminal error conditions, 3.32, 10.1
- Hand-Held Terminal initialisation, 3.6
- Hand-Held Terminal keyboard, 3.4
- Hand-Held Terminal modes, 3.7
- Hand-Held Terminal socket, 2.10
- Hand-Held Terminal specifications, 11.16
- hardware block schematic, 1.4, 11.2
- HD & LD (XPID control block), 4.45
- hexadecimal parameters, 3.30
- high absolute alarm limit (HA), 2.9
- high deviation alarm limit (HD), 2.9
- high select block, 5.33
- HL & LL (analogue output block), 4.19
- HL & LL (manual station block), 4.35
- HO & LO (pseudo analogue output block), 5.70
- hold & track mode indicators, 2.3
- hold mode, 7.1
- HR & LR (analogue input block), 4.12
- HR & LR (analogue output block), 4.18
- HR & LR (pseudo analogue input block), 5.66
- HR & LR (pseudo analogue output block), 5.70
- HR & LR (RPID ratio control block), 4.77
- HS & LS (XPID control block), 4.45
- HSL2 block, 5.33
- HV & LV (manual station block), 4.35
- HV & LV (rate limit block), 5.42
- HY (alarm block), 4.119
- HY (equal block), 5.32

- I/O schematic, 11.15
- ID (command mode), 6.3
- ID (general purpose block), 4.90
- IH & IL (range & limit block), 5.18
- II (command mode), 6.2

II (general purpose block), 4.90
II parameter, 1.3
II parameter and PNO, 8.8
illegal data entry, 10.4
illegal load key, 10.4
illegal parameter mnemonic, 10.4
IN (AICB Block), 5.65
IN (AOCB Block), 5.69
IN (DICB Block), 5.72
IN (DOCB Block), 5.76
initialisation error, 10.4
INO, 8.7
input processing routines (ANIN), 4.9
instrument address, 8.7
instrument errors & diagnostics, 10.3
instrument identity parameter, 6.2
instrument number (INO), 8.7
instrument parameter number (PNO), 8.6, 8.9
INT block, 5.14
integer block, 5.14
integral balance, 7.12
integral desaturation, 7.12, 7.14
interconnecting blocks, 3.19
interconnection address, undefined, 10.6
interconnection destination query, 3.26
interconnection order, 3.21
interconnection types (existing & new), 3.22
invalid connection mnemonic, 10.6
invalid data, 10.5
invalid destination address, 10.5
invalid source address, 10.5
IP (range & limit block), 5.18
isolated output circuit block, 1.10
issue definition (documentation), 11.18

L key, 3.11, 3.14, 3.30
L1 & L2 (general purpose block), 4.91
lamp test parameter, 6.5
latch block, 5.23
less-than block, 5.27
lithium battery, 1.9

LLAG block, 4.94
LN (command mode), 6.5
load keys, 3.11
local setpoint, 2.4, 2.8
logic blocks, comparators, 5.27, 5.30
logic blocks, gates, 5.23
loop display indicators, 2.6
loop number changing (display), 3.19
loop number parameter, 6.5
loop number selection, 4.20
loop number, illegal, 10.6
loops 1 & 2 display, 2.9, 3.19
loops 1 & 2 task scheduling, 9.1
low absolute alarm limit (LA), 2.9
low deviation alarm limit (LD), 2.9
low select block, 5.33
lower button, 2.9
LT (command mode), 6.5
LT block, 5.27
LTCH block, 5.23

M key, 3.11, 3.17, 3.30
MANS block, 4.31
manual intervention on program halt, 4.14
manual mode, 7.1
manual mode select button, 2.8
manual station block, 4.31
manual station block specifications, 11.7
manual station output, 2.6
masking pushbuttons, 2.7
maths blocks, arithmetic, 5.5
maths blocks, operators, 5.11, 5.14, 5.16
maths blocks, operators (two inputs), 5.13
maths blocks, trigonometric, 5.8
MD (RPID ratio control block), R.74
MD (XPID control block), 4.55
mechanical structure, 1.6
median select block, 5.35
memory circuit block, 1.5, 1.8
microprocessor, 1.5
MM & MS (pulse generator block), 5.54
MO (XCON control block), 4.64

MO (manual station block), 4.35
mode entry & operating characteristics, 7.3
mode priorities, 7.1
mode prompt, 3.29
motherboard, 1.5
motherboard switch settings parameter (SW), 6.3
MP (manual station block), 4.36
MPLY block, 5.5
MSL3 block, 5.35
MT (deadtime block), 4.102
multi-drop supervisory link, 8.2
multiply block, 5.5

natural logarithm block, 5.11
negation block, 5.11
negative data loading, 3.11
negative parameters, 3.30
NEGT block, 5.11
NLOG block, 5.11
NOT block, 5.23

OH & OL (range & limit block), 5.18
OP (lead/lag block), 4.98
OP (manual station block), 4.35
OP (range & limit block), 5.18
OP (XCON control block), 4.65
OP (XPID control block), 4.52
open-circuit detection, 1.10
operating modes, 7.1
operator front panel controls specifications, 11.13
operator front panel displays specifications, 11.12
OR2 block, 5.23
OR4 block, 5.23
ordering codes, 11.17
OT (manual station block), 4.35
OT (RAMP block), 5.46
out-of-range data, 10.5
out-of-range detection, 1.10
output, 2.4
output bargraph, 2.6
output isolator circuit block, 1.10

OY to FY (characteriser block), 4.124
OX to FX (characteriser block), 4.124

P1 to P8 (command mode), 6.5
P1 to P8 (general purpose block), 4.91
packaging, 1.3
panel mounting, 1.3
parameter access, 3.9, 3.15
parameter diagrams key, 4.4
parameter entry, 3.10
parameter formats, 3.30
parameter number (PNO), R.6, 8.9
parameter value entry, 3.16
PB (command mode), 6.4
PCNT block, 5.55
PEAK block, 5.59
peak detect max/min block, 5.59
PGNT block, 5.50
PH & PL (XPID control block), 4.45
physical specification, 11.16
PI (general purpose block), 4.91
PID control algorithm, 7.10
pin numbering, 4.3, A.1 (*Appendix A*)
PNO, 8.6, 8.9
polarising pegs, 1.6
positive data loading, 3.11
positive parameters, 3.30
power interruptions, 2.5
power supplies specifications, 11.13
power supply circuit block, 1.10
power supply failure, 2.1
power-on indicators, 2.1
priority number selection, 4.20
process alarm settings, 2.9
process variable, 2.4
process variable bargraph, 2.6
program execution, 3.25
program halt, 2.5, 10.8
program halt error, 1.8
program halt manual intervention, 7.7
PROGRAM write-protect active, 10.7

pseudo analogue input block, 5.63
pseudo analogue output block, 5.68
pseudo digital input block, 5.71
pseudo digital output block, 5.75
pseudo I/O blocks, 1.3
pulse counter block, 5.55
pulse generator block, 5.50
pushbuttons, 2.4, 2.7
PV (alarm block), 4.52
PV (XPID control block), 4.120

Q key, 3.27

RA (RPID ratio control block), 4.76
raise button, 2.9
RAM area, 1.8
RAM battery, 2.5
RAMP block, 5.43
RANG block, 5.16
range & limit block, 5.16
RATE block, 5.39
rate limit block, 5.39
ratio control block (RCON), 4.79
ratio control block (RCON) specifications, 11.6
ratio control block (RPID), 4.66
ratio control block (RPID) specifications, 11.6
ratio mode, 2.4
ratio mode select, 2.8
ratio setpoint display, 2.8
ratio setting, 2.4
RB (RPID ratio control block), 4.78
RCON block, 4.79
read-only parameters, illegal input, 10.5
read/write constants block, 5.21
reliability, 1.3
remote auto or ratio mode, 7.1
remote/ratio mode select, 2.8
RFI susceptibility, 11.14
RL (RAMP block), 5.46
RL (XPID control block), 4.47
RO (RAMP block), 5.46

RO (rate limit block), 5.42
ROM area, 1.8
ROOT block, 5.11
RPID block, 4.66
RS (RPID ratio control block), 4.78
RS232 port, 1.3
RS232 socket, 8.2
RS422 communications, 1.3
RS422 communications task scheduling, 9.1
RS422 connectors, 8.2
RT (RPID ratio control block), 4.78

SAMP block, 5.21
SB (XPID control block), 4.47
SC digital outputs (in strategy), 10.8
SC (command mode), 6.6
SC OK message, 3.19
scroll facility, 3.15
scroll key, 3.28
scroll keys, assigned blocks, 3.18
select block, 5.37
selector blocks, 5.33, 5.35, 3.37
serial data communications, 8.2
serial data transmission, 8.2
setpoint adjustment, 2.9
setpoint bargraph, 2.7
setpoint display, 2.8
shift mode, Hand-Held Terminal, 3.4
SI, S1 - S4, AA, 1T - 4T (general purpose block), 4.91
sign display, 3.17
SIN block, 5.8
single-board technology, 1.3
SL (XPID control block), 4.46
SLCT block, 5.37
SM (XPID control block), 4.57
SM parameter, 2.7
source address, invalid, 10.5
source of block interconnection, 3.20
SP (alarm block), 4.120
SP (XPID control block), 4.52
space key, 3.12

specifications, *11.1*
square root block, *5.11*
SR (RPID ratio control block), *4.77*
SR (XPID control block), *4.46*
ST (alarm block), *4.118*
ST (analogue input block), *4.9*
ST (analogue output block), *4.17*
ST (characteriser block), *4.123*
ST (constants blocks), *5.20*
ST (deadtime block), *4.101*
ST (digital input block), *4.24*
ST (digital output block), *4.28*
ST (display block), *4.112*
ST (equal block), *5.31*
ST (general purpose block), *4.88*
ST (greater than/less than blocks), *5.28*
ST (lead/lag block), *4.96*
ST (manual station block), *4.34*
ST (maths arithmetic blocks), *5.6*
ST (maths trigonometric blocks), *5.9*
ST (median select block), *5.36*
ST (peak detect max/min block), *5.60*
ST (pulse counter block), *5.57*
ST (pulse generator block), *5.52*
ST (pseudo analogue input block), *5.64*
ST (pseudo analogue output block), *5.69*
ST (pseudo digital input block), *5.72*
ST (pseudo digital output block), *5.76*
ST (RAMP block), *5.45*
ST (range & limit block), *5.17*
ST (rate limit block), *5.41*
ST (SAMP block), *5.22*
ST (timer block), *5.49*
ST (totalisation block), *4.106*
ST (XPID control block), *4.43*
standby, *1.9*
steering diodes, *1.7*
store/recall database, *6.6*
string variables, *3.30*
SUBT block, *5.5*
subtract block, *5.5*

sumcheck error message, 3.19
sumcheck error, function block, 10.8
supervisory computer, 1.56, 8.1
SW (command mode), 6.3
system grounding, 11.14

TA (RAMP block), 5.42
TA (rate limit block), 5.42
TAN block, 5.8
task scheduling, 9.1
terminal control keys, 3.11, 3.27
termination assembly, 1.6
TI & TD (XPID control block), 4.50
TIME block, 5.47
timer block, 5.47
timing accuracy, 11.11
totalisation block, 4.103
totalisation block specifications, 11.8
TOTL block, 4.103
track mode, 7.1
transmitter power supply, 1.10
trip-and-try again circuit, 1.11
TRU option, 1.6
TS (XPID control block), 4.51

UID, 8.2
UID and INO, 8.7
unsigned parameters, 3.30

VDU terminal socket, 2.10

W key, 3.14, 3.28
WAIT message, 3.25
warranty & after-sales service, 11.17
watchdog circuit, 1.8
watchdog failure, 2.1, 9.4
WM (digital output block), 4.29
WM (pseudo digital input block), 5.73
write-protect (EEPROM) active, 10.8
write-protect (PROGRAM) active, 10.7
write-protection, 1.8

XCON block, 4.50
XK (lead/lag block), 4.97
XM (digital input block), 4.24
XM (pseudo digital output block), 5.73
XOR2 block, 5.23
XP (XPID control block), 4.50
XPID block, 4.37

Z key, 3.12, 3.29