



# 7300S User Manual

Three Phase Solid State Contactor  
Issue 4

HA176661ENG  
July 2012



---

**7000 RANGE**

***7300S***  
***SMART CONTROLLER***

**THREE-PHASE**  
**SOLID STATE CONTACTOR**

**User Manual**

© Copyright Eurotherm Limited 2003

All rights reserved. All reproduction or transmission in any form whatsoever and using any procedure (electronic or mechanical, including photocopying and recording) without written permission from Eurotherm is strictly prohibited.

# COMMISSIONING FLOWCHART

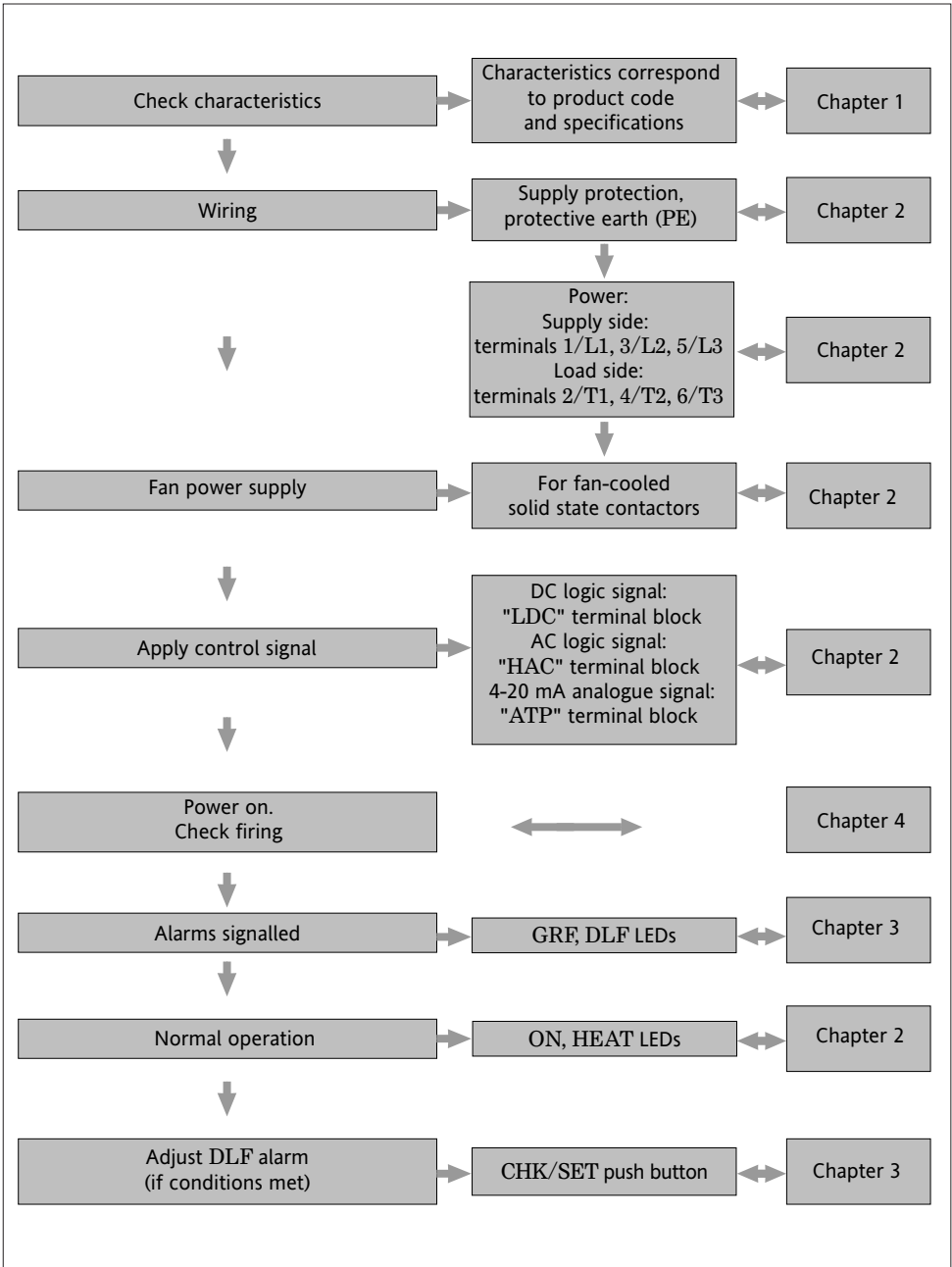

## CONTENTS

	Page
Commissioning flowchart .....	.ii
European directives and applicable standards .....	.iv
<b>Chapter 1</b> Identification of solid state contactor .....	.1-1
<b>Chapter 2</b> Installation .....	.2-1
<b>Chapter 3</b> Alarms .....	.3-1
<b>Chapter 4</b> Maintenance .....	.4-1
<b>Eurotherm Limited</b> .....	.5-1

## PURPOSE OF MANUAL

This manual ( Issue **4** ) describes the Basic Version and all Options for 7300S series solid state contactors with current ratings **up to 160 A**.

# EUROPEAN DIRECTIVES AND APPLICABLE STANDARDS

## COMPLIANCE WITH PRODUCT STANDARD

7300S products comply with the terms of product standard **EN 60947-4-3** 'Contactors and motor-starters - AC semiconductor controllers and contactors for non-motor loads'.

## CE LABELLING

7300S products, installed and operated in accordance with their user manual, bear CE labelling on the basis of compliance with the essential requirements of :

- the **European Low Voltage Directive** 73/23 EEC dated 19 February 1973 modified by 93/68 EEC dated 22 July 1993
- the **Electromagnetic Compatibility Directive** 89/336/EEC dated 3 May 1989 modified by 92/31/EEC dated 28 April 1992 and 93/68/EEC dated 22 July 1993.

## SAFETY

The units have IP20 protection rating as defined by standard IEC 60529. External wiring must comply with standards IEC 60364-4-43 and IEC 60943. Copper cables and conductors must be used, rated to a temperature of 75°C (167°F).

## ELECTROMAGNETIC COMPATIBILITY (EMC) TEST STANDARDS

7300S products installed and used in accordance with the user manual, are designed for an industrial environment and not a commercial or light industrial premises and must not be used in the home.

## IMMUNITY

The EMC immunity test standards required by product standard EN 60947-4-3 are given in the table following :

Test type	Minimum level	EMC test standard
Electrostatic discharge	4 kV on contact; 8 kV in air	EN 61000-4-2
Radiated, radio frequency electromagnetic field	10 V/m 80 MHz $\leq f \leq$ 1 GHz ; 80% modulation 1 kHz sinusoid	EN 61000-4-3
Electrical fast transient / burst	2 kV / 5 kHz	EN 61000-4-4
Electrical Surge	4 kV line to earth 2 kV line to line	EN 61000-4-5
Conducted disturbances	140 dB $\mu$ V; 150 kHz $\leq f \leq$ 80 MHz	EN 61000-4-6
Voltage dips and short interruptions	5 s interruptions	EN 61000-4-11

Table 1 EMC immunity standards compliance

## EMISSIONS

The EMC emissions test standards required by product standard EN 60947-4-3 are given in the table following :

<b>Emission type</b>	<b>Firing mode</b>	<b>EMC test standard</b>
Radiated at radio frequencies	All firing modes	CISPR 11 Class A
Conducted at radio frequencies	All firing modes	CISPR 11 Class A Group 2

Table 2 EMC emissions standards compliance

## EMC GUIDE

To help you deal with installation-dependent electromagnetic interference effects, Eurotherm provides an ‘Electromagnetic compatibility’ installation guide (ref. HA 025464) which sets out best current practice regarding EMC.

## DECLARATION OF CONFORMITY

A CE declaration of conformity is available on request.

---



# Chapter 1

## 1. IDENTIFICATION OF SOLID STATE CONTACTOR UNITS

Contents	Page
1.1. General presentation .....	1-2
1.2. Technical specifications .....	1-5
1.2.1. Use .....	1.5
1.2.2. Power .....	1.5
1.2.3. Load .....	1.5
1.2.4. Signalling .....	1.5
1.2.5. Firing Modes .....	1.6
1.2.6. Inputs .....	1.6
1.2.7. Control .....	1.6
1.2.8. Alarms .....	1.7
1.2.9. Protection .....	1.7
1.2.10. Environment .....	1.8
1.2.11. Dimension .....	1.8
1.2.12. Mounting .....	1.8
1.2.13. Digital Communication .....	1.8
1.3. Coding .....	1-10

# 1. Chapter 1 IDENTIFICATION

## 1.1 GENERAL PRESENTATION

7300S series solid state contactors control the **electrical power** to three-phase industrial loads such as low temperature coefficient and short wave infrared elements.

Standard ratings in the series range from **16 A** to **160 A**, at voltages from **200 V** to **500 V**.

7300S series solid state contactors comprise three channels, **controlled by thyristors**.

Depending on the type of control signal and the type of input specified, 2 operating modes are available: logic ('on/off') or modulation ('Burst mode').

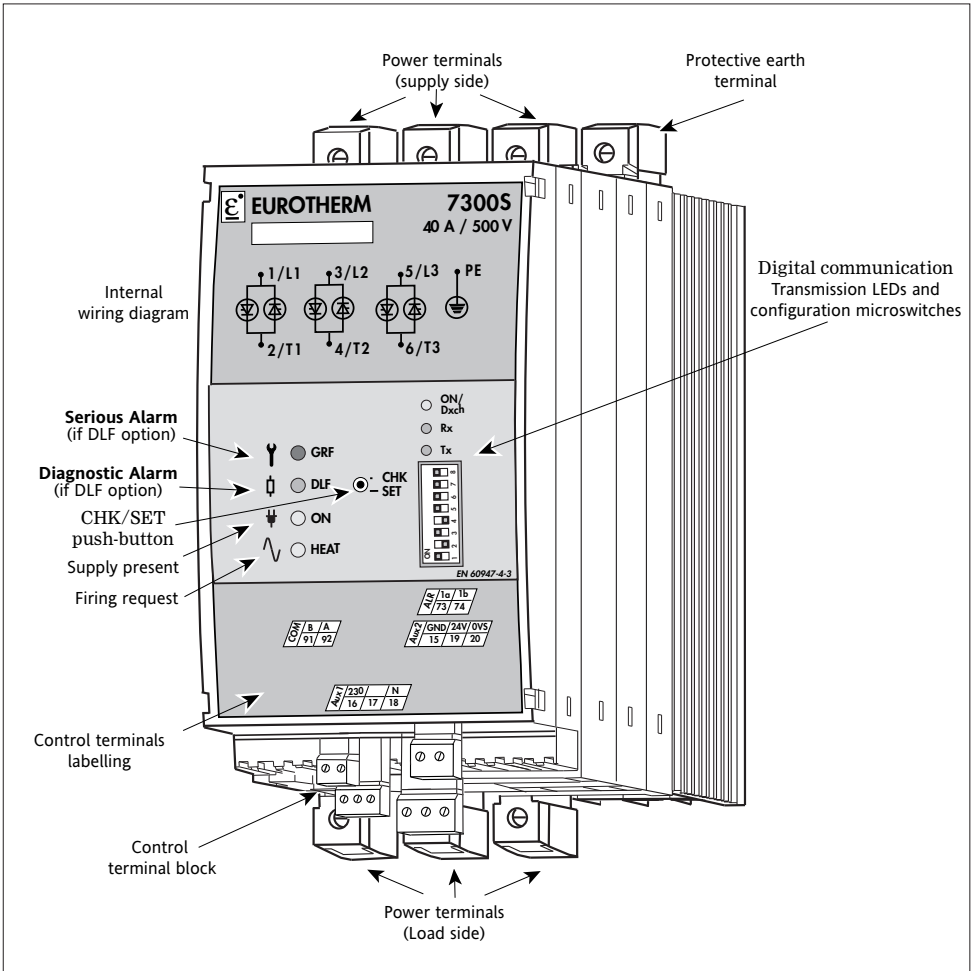

Figure 1-1 General view of 7300S with digital communication control - ratings from 16 A to 40A

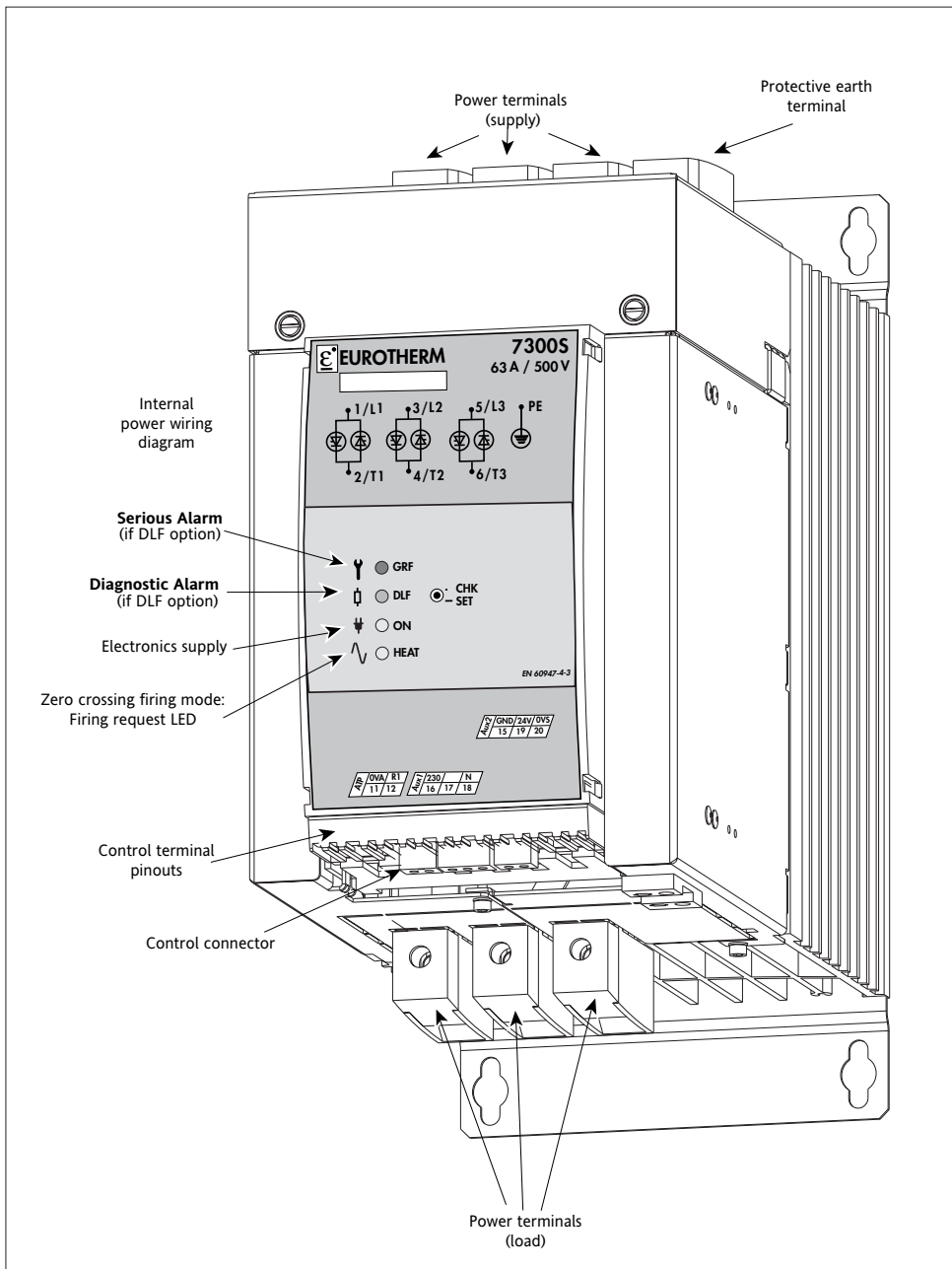

Figure 1-2 General view of 7300S with analogue control - ratings from 63 A to 100 A

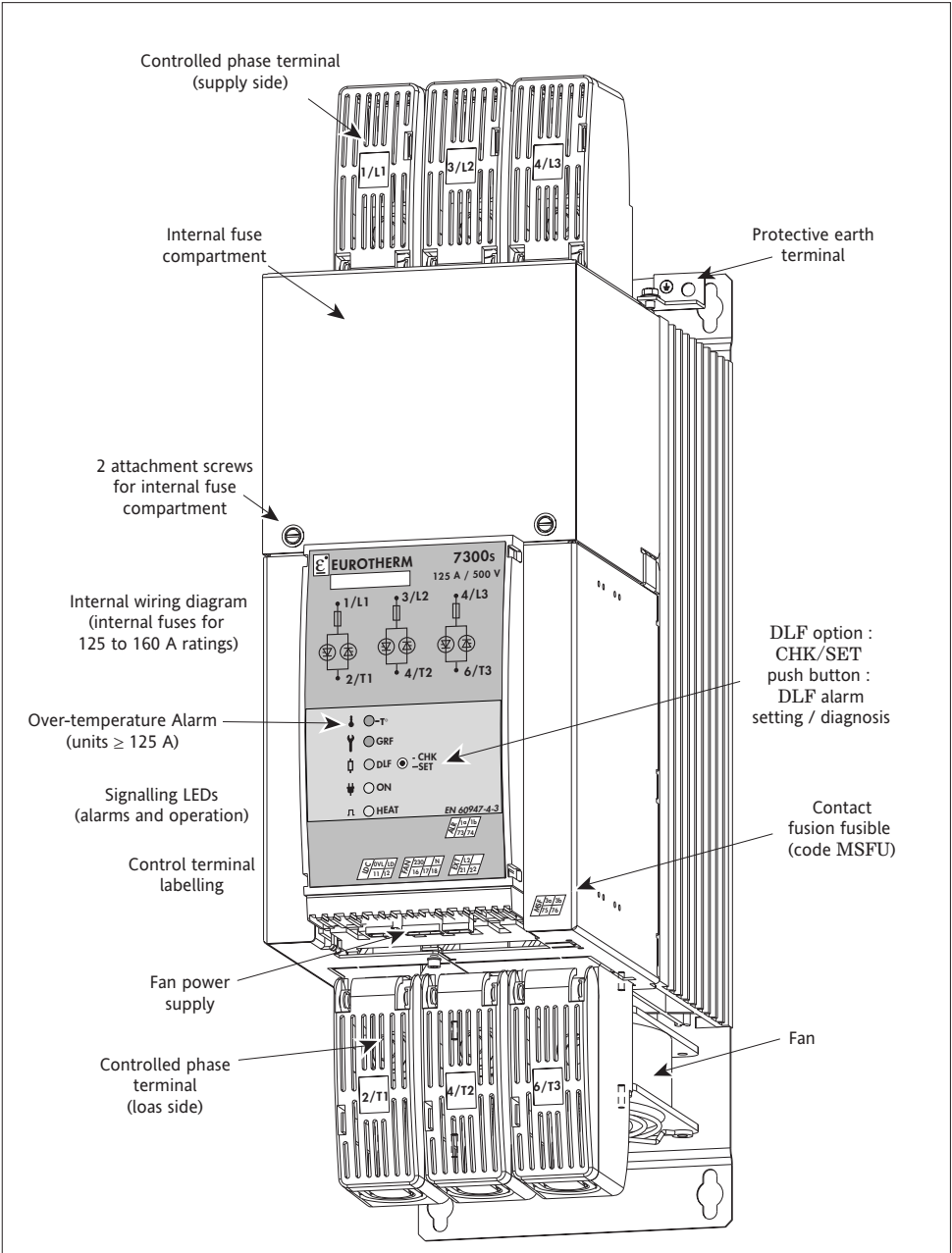

Figure 1-3 General view of 7300S with analogue control - ratings  $\geq 125$  A

## 1.2. TECHNICAL SPECIFICATIONS

### 1.2.1. USE

In accordance with product standard EN 60947-4-3:

Units for uninterrupted service :

1. Semiconductor contactor (DOL) variant 5 :  
logic input signal : DC (LDC input) or AC (HAC input).
2. Thyristor unit variant 4 :  
4-20 mA analogue input signal : ATP input or  
digital communication option.

Configuration on order.

### 1.2.2. POWER

Nominal current per phase

16 A to 160 A (defined at 45°C) depending on product code  
The unit can be used up to 60°C ambient temperature,  
following derating curves. Please consult Eurotherm.

Nominal line to line voltage

200 V to 500 V depending on product code (+10% and -15%).

Frequency

Use from 47 to 63 Hz (automatic matching)

Dissipated power

Approx : 1.3 W (typical) - 2 W max per amp and per phase  
(with fuses).

Cooling

Ratings  $\leq$  100 A: natural convection

Ratings  $\geq$  125A: fan (115 V or 230 V external supply),  
consumption 10 VA.

### 1.2.3. LOAD

Categories of use

Three-phase Industrial Load.

The categories of use applicable for each unit are indicated  
on the identification label

- AC-51 Non-inductive or low inductance loads, furnace  
resistances  
(Resistive load with low temperature coefficient).
- AC-55b Switching of incandescent lamps, short wave  
infrared elements (SWIR), for  $\leq$  100 A units.

Connections

Independent of order of phase rotation

Load configuration

- Star with neutral (4 wires)
- Star without neutral (3 wires)
- Closed delta (3 wires)
- Open delta (6 wires).

### 1.2.4. SIGNALLING

#### Basic version

Supply present

Green 'ON' LED.

Thyristor firing request

Green 'HEAT' LED.

#### With options

Alarms

Red and orange LEDs, alarm relay contact.

## 1.2.5. FIRING MODES

### Thyristor switching

At thyristor zero voltage crossing.

#### 'Logic' mode

DC signal applied to LDC input (Low Direct Current).  
AC signal applied to HAC input (High Alternating Current).

#### 'Burst' mode

Supply voltage modulated by the 4-20 mA analogue signal applied to the ATP input (Analogue to Time Proportional).  
Firing base time: 0.3 s (approx. 15 cycles at 50 Hz).

- with 'Digital Communication' option  
base modulation time: from 1 cycle ('Single-cycle' mode)  
(or 1 half-cycle in 'Advanced single-cycle' mode)  
to 255 cycles.

## 1.2.6. INPUTS

### Power Supply

Self-powered electronics.

#### 'Logic' firing:

- DC signal  
(LDC input)

Conducting from 4.5 Vdc to 32 Vdc max, current  $\geq 9$  mA.  
Off  $< 1.5$  V or  $< 0.1$  mA. Response time  $\leq 10$  ms.  
If the unit has the DLF option, ant that you want to drive it using a REMIO output or i7000, please contact the Eurotherm's application services

- AC signal  
(HAC input)

Conducting from 85 to 253 Vac max. Impedance  $\approx 7$  k $\Omega$  at 50 Hz.  
Off  $< 10$  Vac. Response time  $\leq 60$  ms.  
(If an RC snubber contact protection circuit or control optotriac is used, the maximum capacitor value is 22 nF for 240 Vac).

- With DLF option :

- According to the control signal, one of the two following criteria must be respected:
  - $T_{\text{conduction min}} = T_{\text{non-conduction min}} \geq 0.3$  second
  - $T_{\text{modulation}} \geq 4$  seconds

*If DLF option is used with Short Wave Infrared loads (SWIR), the product is not UL approved.*

#### 'Burst mode' firing:

- Analogue signal  
(ATP input)

4 - 20 mA (10 Vdc max).  
Modulation depending on signal.  
Firing base time: 0.4 s @ 50 % and 50 Hz.

- Digital communication  
(MOP option)

Digital signals, Modbus® protocol

## 1.2.7. CONTROL - ATP input only

### Control type

Open loop

### Linearity and Stability

Better than  $\pm 2\%$  of full scale.

## 1.2.8. ALARMS (Options)

### DLF option

Serious alarms	Total load failure (TLF) and thyristor short circuit (THSC) detection.
Signalling	When a serious alarm is detected: <ul style="list-style-type: none"> <li>• the red 'GRF' LED is lit</li> <li>• the alarm relay contact is activated.</li> </ul>
Diagnostic alarm	Partial load failure detection and diagnosis.
Signalling	If a partial load failure (PLF fault) is detected: <ul style="list-style-type: none"> <li>• the orange 'DLF' LED is lit</li> <li>• the alarm relay contact is activated.</li> </ul>
Settings	The front panel push button is used for: <ul style="list-style-type: none"> <li>• monitoring and diagnosis</li> <li>• adjusting and resetting the alarm.</li> </ul>
Sensitivity	Detects the failure of at least : <b>1 element out of 4 in 3S, 4S, 6D configuration</b> <b>1 element out of 3 in 3D configuration</b>

### Over-temperature alarm

For all fan-cooled units ( $\geq 125$  A), the unit cuts out if the temperature threshold is exceeded, whether or not options are fitted.

Signalling	If an over-temperature alarm is detected: <ul style="list-style-type: none"> <li>• the red 'T°' LED is lit</li> <li>• the alarm relay contact is activated</li> </ul> provided one of the alarm options is selected.
------------	--

### Alarm relay

Available with one of the Alarm options.  
 The relay contact (0.25 A/230 Vac or 30 Vdc) is either open on alarm or closed on alarm depending on the product code.

## 1.2.9. PROTECTION

Short circuits	Type 1 (high-speed fuses).
co-ordination type	IP20 without adding additional protection.
Electrical protection	Varistors and RC snubbers.
Thyristors	High-speed fuses: <ul style="list-style-type: none"> <li>• ratings <math>\leq 100</math> A: external (selected in product code)</li> <li>• ratings <math>\geq 125</math> A: internal.</li> </ul>
Replacement fuses	No fuse for short wave infrared elements. See chapter 4.

### 1.2.10. ENVIRONMENT

Use	0 to 45°C at nominal current, at maximum altitude of 1000 m.
Storage	-10°C to 70°C.
Isolation voltage	Assigned isolation voltage $V_i = 500 V_{rms}$
Pollution	Degree 2 acceptable (defined by IEC 60664).
Humidity	RH 5% to 95%, non-condensing, non-streaming.
Over-voltage	Over-voltage category II (as defined by IEC 60664) $V_{imp} = 4 \text{ kV}$ .

### 1.2.11. DIMENSIONS

Ratings	Height	Width	Depth (mm)			
			Basic	With Modbus only	With DLF only	With Modbus and DLF
16 A to 40 A	220 mm	96 mm	164	189	214	239
63 A to 100 A	305 mm	144 mm	295	295	372	372
125 A to 160 A	498 mm	144 mm	295	295	372	372

Table 1-1 Units dimensions according to the ratings and the options chosen

### 1.2.12. MOUNTING

Attachment	Attachment plate fixed to unit: <ul style="list-style-type: none"> <li>• on symmetrical EN50022 DIN rail or</li> <li>• bulkhead mounting</li> </ul> (for ratings $\geq 63 \text{ A}$ : bulkhead mounting only).
------------	---

### 1.2.13. DIGITAL COMMUNICATION

Availability	The digital communication option is exclusive with: <ul style="list-style-type: none"> <li>• control using the logic or analogue input signal.</li> </ul>
Protocol Compliance	Modbus® RTU. Communication complies with the specifications given in 'GOULD MODICON Protocol Reference Guide PI-MBUS-300 rev J'.
Power supply	24 Vac ( $\pm 20\%$ ), 47 to 63 Hz or 24 Vdc ( $\pm 20\%$ ) non-polarised. Typical consumption 1.5 VA Protection: external 2 A fuse. External wiring should comply with standard IEC 60364.
Transmission	Standard RS485, 2 wires. Speed: 9600 or 19200 baud. Selected by switch on front panel. The speed is factory set to correspond to the selected product code.



---

Termination	The communication bus must have termination resistors fitted at each end: <ul style="list-style-type: none"><li>• one line impedance matching resistor.</li><li>• two RS485 bus polarisation resistors.</li></ul>
Address	Adjustable between 1 and 127 using front panel switches only. The physical address is factory configured to 32 by default.
Diagnostic	<ul style="list-style-type: none"><li>• Green LED on front panel indicates power presence, waiting for frames, communication established.</li><li>• Two orange LEDs show the status of the communication bus (transmission or reception).</li></ul>
Control	Supply voltage compensation operates for variations up to $\pm 20\%$ of nominal voltage, using $V^2$ control
Parameters and operating mode	Read and write by digital communication (see Digital communication manual, part No. HA176664ENG).
Firing base time	Configurable over communication link (@ 50% of power): <ul style="list-style-type: none"><li>• 1 or 255 cycles ('Burst mode').</li></ul> The default base time is factory configured to 16 cycles.

## CODING

## 7300S Current / Voltage / Fan / Configuration / Fuses / Input / Language / Options

1. Nominal current per phase	Code
16 amps	<b>16A</b>
25 amps	<b>25A</b>
40 amps	<b>40A</b>
63 amps	<b>63A</b>
80 amps	<b>80A</b>
100 amps	<b>100A</b>
125 amps	<b>125A</b>
160 amps	<b>160A</b>

2. Nominal line-to-line voltage	Code
200 volts to 230 volts	<b>230V</b>
277 volts	<b>277V</b>
400 volts to 500 volts	<b>500V</b>

3. Fan	Code
≤ 100 A : no fan	<b>XXXX</b>
≥ 125 A: fan	
• 115 V supply	<b>115V</b>
• 230 V supply	<b>230V</b>

4. Load configuration	Code
Star without neutral	<b>3S</b>
Star with neutral	<b>4S</b>
Closed delta	<b>3D</b>
Open delta	<b>6D</b>

5. High-speed fuses	Code
Thyristor protection fuses only	
• without microswitch	<b>FUSE</b>
• with microswitch	<b>MSFU</b>
( ≤ 100 A: external fuses ≥ 125 A: internal fuses)	
No fuses or control of Short wave infrared elements	<b>NONE</b>

6. Input	Code
'On/off' firing	
DC logic signal	
4.5 Vdc to 32 Vdc	<b>LDC</b>
AC logic signal	
85 Vac to 253 Vac	<b>HAC</b>
'Burst mode' firing	
Analogue DC signal	
4 mA to 20 mA	<b>ATP</b>

7. Manual language	Code
French	<b>FRA</b>
English	<b>ENG</b>
German	<b>GER</b>

8. Selected options	Code
No options	
<b>End of code</b>	<b>NONE</b>
Selection of options	<b>YES</b>

<b>Alarm option:</b> <b>Communication option: Certificate</b> <b>/ Alarm / Load / Contact / Protocol / Transmission / option / Warranty</b> <b>selected    Type            Type</b>
---

9. Alarm option <i>(Options selected: YES)</i>	Code
Partial load failure and Serious alarms	<b>DLF</b>
No alarms	<b>NONE</b>

12. Communication option	Code
Digital communication Communication protocol: Modbus®	<b>MOP</b>
No communication	<b>NONE</b>

10. Load type	Code
<i>For DLF option:</i> • Resistive load with low temperature coefficient Short wave infrared elements*	<b>LTCL</b> <b>SWIR</b>
<i>Without DLF option</i>	<b>XXXX</b>

13. Transmission speed <i>(Comm. option other than NONE)</i>	Code
Transmission speed: 9.6 kbaud 19.2 kbaud	<b>9K6</b> <b>19K2</b>
No communication	<b>XXXX</b>

11. Alarm relay contact	Code
<i>GRF or DLF option:</i> Alarm relay contact • Closed on alarm • Open on alarm	<b>NC</b> <b>NO</b>
<i>Without alarm option</i>	<b>XX</b>

14. Certification option	Code
Without Certificate of 'Compliance with Order'	<b>NONE</b>
With certificate of 'Compliance with Order'	<b>CFMC</b>

*\*DLF Option with SWIR loads is not UL approved.*

15. Warranty Extension	Code
Without warranty extension	<b>NONE</b>
With warranty extension to 5 years	<b>CFMC</b>



## Chapter 2

### INSTALLATION

Contents	Page
<b>2.1. Safety during installation</b> .....	2-2
<b>2.2. Mounting</b> .....	2-3
<b>2.2.1. Types of mounting</b> .....	2-3
<b>2.2.2. Attachment plates</b> .....	2-3
<b>2.2.3. Mounting on DIN rails</b> .....	2-3
<b>2.2.4. Bulkhead mounting</b> .....	2-4
<b>2.3. Wiring</b> .....	2-5
<b>2.3.1. General connection diagram</b> .....	2-5
<b>2.3.2. Power connections</b> .....	2-7
<b>2.3.2.1. General</b> .....	2-7
<b>2.3.2.2. Power connection details</b> .....	2-7
<b>2.3.2.3. Three-phase load wiring schemes</b> .....	2-7
<b>2.3.3. Control terminal blocks</b> .....	2-9
<b>2.3.3.1. Control signal</b> .....	2-9
<b>2.3.3.2. Alarm relay contact (option)</b> .....	2-9
<b>2.3.3.3. Connecting the reference neutral voltage</b> .....	2-10
<b>2.3.3.4. Fan power supply</b> .....	2-10
<b>2.3.3.5. Connecting the digital communication</b> .....	2-11

## 2. Chapter 2 INSTALLATION

### 2.1. SAFETY DURING INSTALLATION (MOUNTING AND WIRING)

#### Danger!



- 7300S solid state contactors must be installed and wired by qualified staff authorised to work on low voltage industrial electrical facilities.

- Units must be installed in a fan-cooled cabinet, to ensure that condensation and pollution are excluded, with a class of at least 2 (according to IEC 60664). We recommend fitting fan-cooled cabinets with a fan failure detection device or a safety cut-out triggered by the internal temperature of the cabinet. Cabinets must be closed and connected to the protective earth according to IEC 60364 or applicable national standards.

#### Important!



- Units must be mounted with the heatsink positioned vertically, and with no obstructions above or below the unit which could reduce or hamper air flow. If several units are fitted in the same cabinet, arrange them such that air from one unit is not drawn in by the unit above.

The ambient temperature beneath the unit must not exceed 45°C. Leave a gap of at least 10 mm between adjacent units.

#### Important!



- Nominal currents correspond to use at ambient temperatures of no more than 45°C. Overheating may cause incorrect operation and may even lead to components being damaged.

#### Danger!



- It is the user's responsibility to wire and protect the facility according to best practice and applicable standards.

A suitable device, ensuring that the unit can be electrically isolated from the supply, must be installed upline to enable work to be performed safely.

Conductor cross-sections should comply with IEC 60943.

Only use copper cables and wires rated for use at 75°C.

- Before connecting or disconnecting the unit check that power and control cables and leads are isolated from voltage sources.

The protective earth must be connected before any other connections are made and should be the last cable to be disconnected.

The protective earth connection terminal is marked with the symbol:



#### Important!



- To ensure that 7300S solid state contactors comply with Electromagnetic Compatibility requirements, ensure that the panel or DIN rail to which they are attached is correctly grounded.

The ground connection, designed to ensure **ground continuity**, is not in any way a substitute for the protective earth connection.

- Run low voltage and power cables in separate cable ducts or trays.

## 2.2. MOUNTING

### 2.2.1. TYPES OF MOUNTING

- DIN rail mounting - 16 A to 40 A only
- Bulkhead mounting with screws  $\geq 63$  A.

DIN rail mounting ( $\leq 40$ A only)		Bulkhead mounting	
<b>Attachment plate</b> Two horizontal plates	<b>DIN rail</b> Two symmetrical rails EN 50022	<b>Attachment plate</b> Two horizontal plates	<b>Screws</b> $4 \times M4$ ( $\leq 40$ A) $4 \times M6$ ( $\geq 63$ A)

Table 2-1 Attachment details for both mounting types

### 2.2.2. Attachment plates (figures 2-1 to 2-4)

Two factory-fitted attachment plates on the rear of the 7300S solid state contactor are used :

- to clip the unit to a DIN rail, or
- to screw the unit to a bulkhead.

Each attachment plate has:

- attachment holes for bulkhead mounting, and
- two fixed hooks and two mobile hooks for clipping to a DIN rail. (the mobile hooks are moved using a catch and spring).

### 2.2.3. Mounting on DIN rails

- fix two symmetric DIN rails (for units rated 16 A to 40 A) in accordance with the unit dimensions and safety recommendations
- bring the unit up against the top rail, engaging the two fixed hooks on the top attachment plate
- push the unit against the rail
- clip the unit onto the bottom rail using the mobile hooks on the bottom attachment plate, ensuring that they are properly engaged.

To **remove** the unit:

- move the mobile hooks downwards by pulling the catch on the bottom attachment plate
- unclip the unit from the rail.

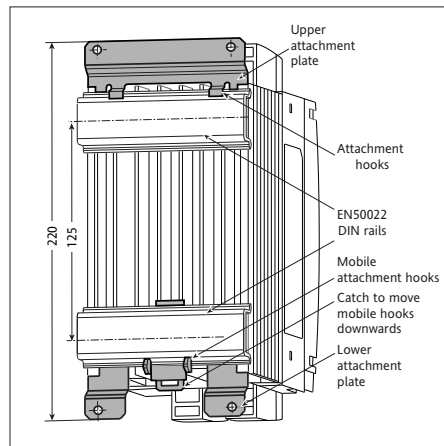

Figure 2-1 Attaching the 7300S to DIN rails

### 2.2.4. Bulkhead mounting

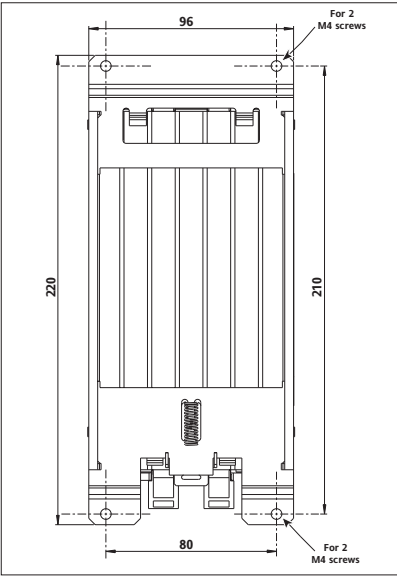

Figure 2-2 Units from 16 A to 40 A

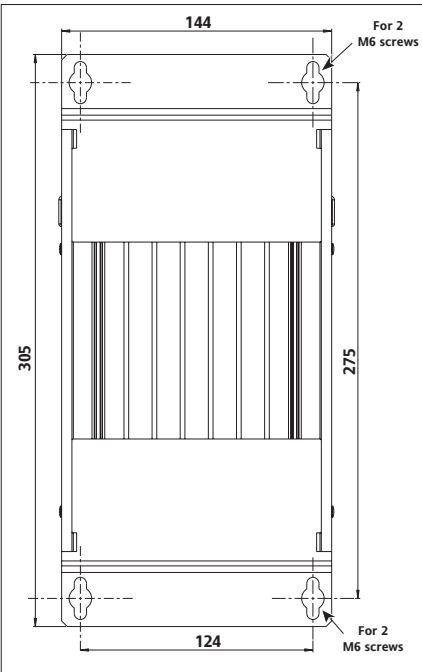

Figure 2-3 Units from 63 A to 100 A

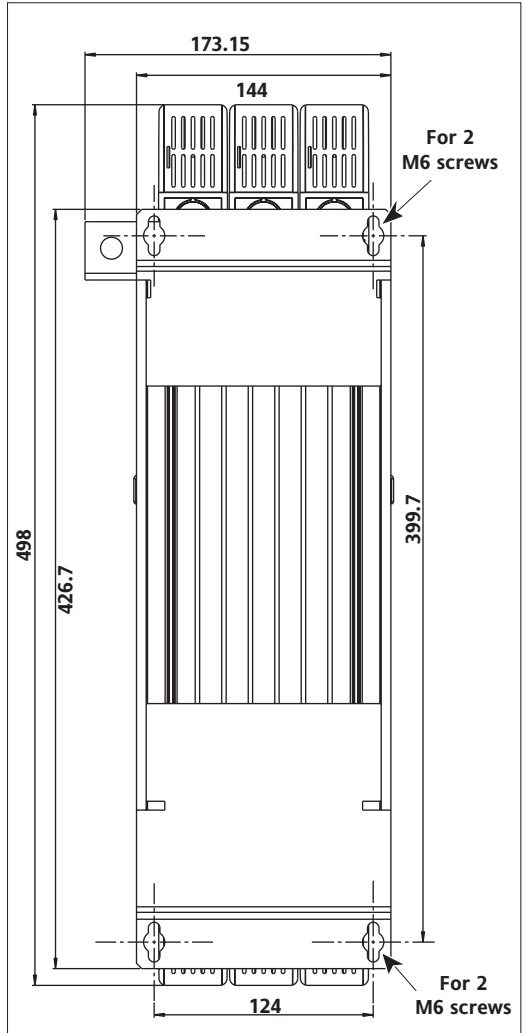

Figure 2-4 Units  $\geq$  125 A



## 2.3. WIRING

### 2.3.1. GENERAL CONNECTION DIAGRAM

The general connection diagram shows the power terminals (independent of the three-phase load configuration) and control connectors.

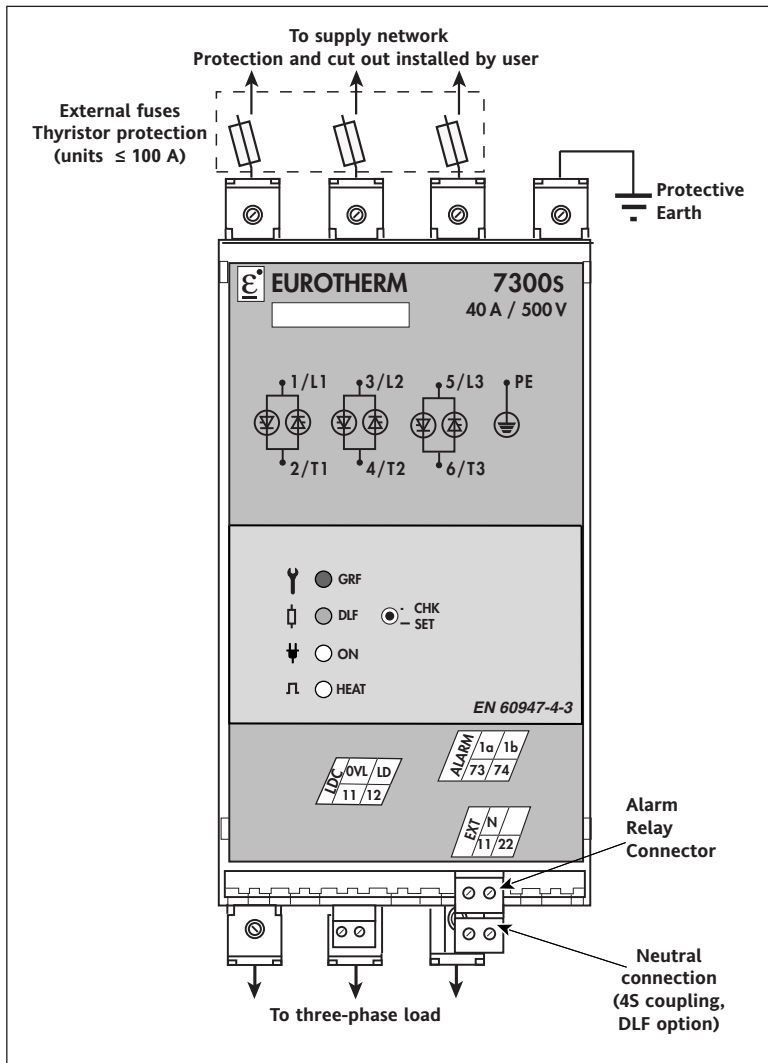

Figure 2-5 General connection diagram for ≤ 100 A units

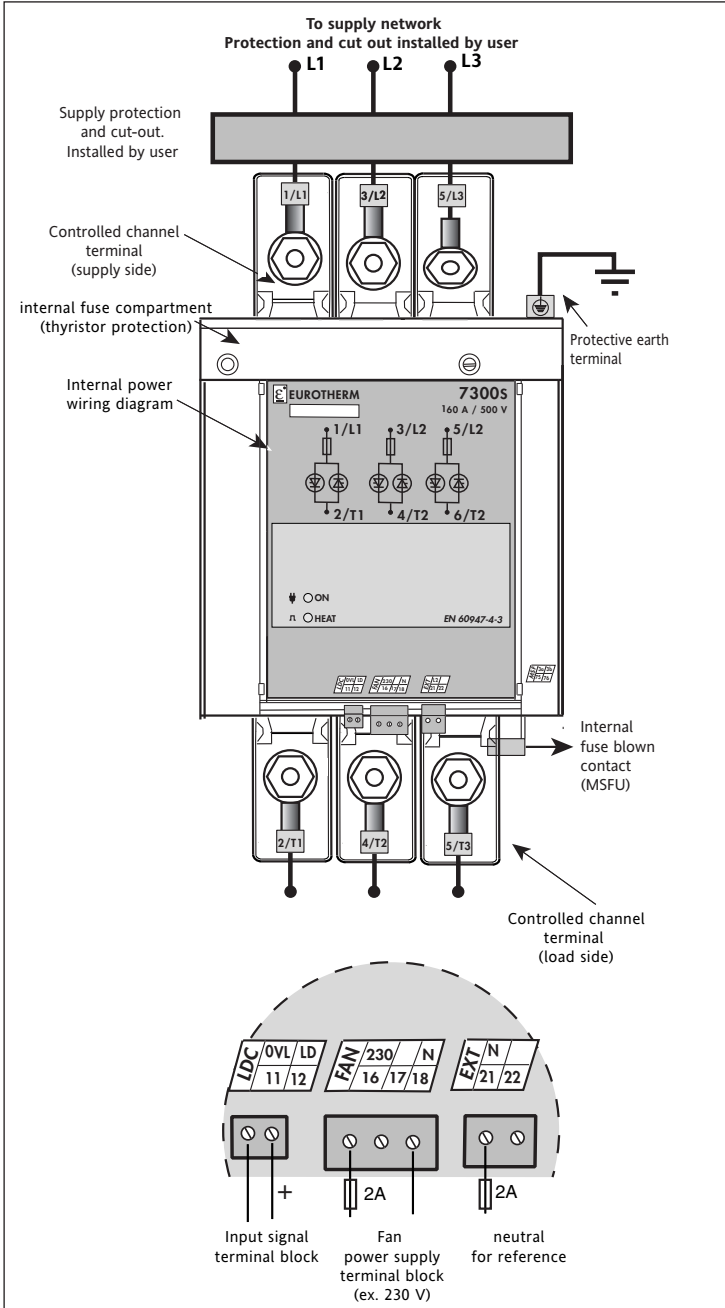

Figure 2-6 General connection diagram for  $\geq 125$  A units

## 2.3.2. POWER CONNECTIONS

### 2.3.2.1. General

7300S solid state contactors comprise three channels controlled by thyristors.

Terminals 1/L1, 3/L2 and 5/L3 must be wired to the three-phase supply network. Terminals 2/T1, 4/T2 and 6/T3 must be wired to the three-phase load.

The protective earth terminal PE (marked with the earth symbol) must be wired to the protective earth (see section 'Safety during installation' - page 2-2).

### 2.3.2.2. Power connection details

Rating A	Terminal capacity		Torque Nm	Stripping length mm
	mm <sup>2</sup>	AWG		
16 to 25	2.5 to 6	13 to 9	1.2	13
40 to 63	6 to 16	9 to 5	1.8	13
80 to 100	16 to 35	5 to 2	3.8	20
125	50 to 120	0	16.4 (or 28.8)	ø 10 (or ø 12)
160	70 to 120	00	M10 nut (17 mm wrench) to attach eyelet and terminal.	

Table 2-2 Power connection details for ratings from 16 A to 160 A

Conductor cross-sections should comply with IEC 60943.

Use 75°C copper wire only.

### 2.3.2.3. Three-phase load wiring schemes

Power connections to the unit depend on the load configuration.

The following four configuration schemes may be used for three-phase loads:

- star without neutral (3 connection wires, code 3S), figure 2-7
- closed delta (3 connection wires, code 3D), figure 2-8
- star with neutral (4 connection wires, code 4S), figure 2-9
- open delta (6 connection wires, code 6D), figure 2-10.

Configuration type	Load voltage	Load current	Important note
Star without neutral	$V_{L-L} / \sqrt{3}$	Current in one line of thyristors $I_{Th}$	-
Star with neutral	$V_{L-N}$	Current in one line of thyristors $I_{Th}$	-
Closed delta	$V_{L-L}$	$I_{Th} / \sqrt{3}$ Balanced load	-
Open delta	$V_{L-L}$	Current in one line of thyristors $I_{Th}$	It is essential to connect the loads as shown in figure 2-10

Table 2-3 Characteristics of different balanced three-phase load configuration schemes

$V_{L-L}$ : Line-to-line voltage;  $V_{L-N}$ : Line-to-neutral voltage;  $I_{Th}$ : Thyristor line current

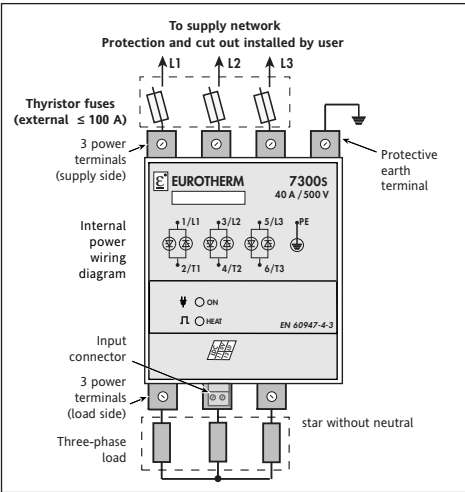

Figure 2-7 Connecting a three-phase load using Star without neutral configuration

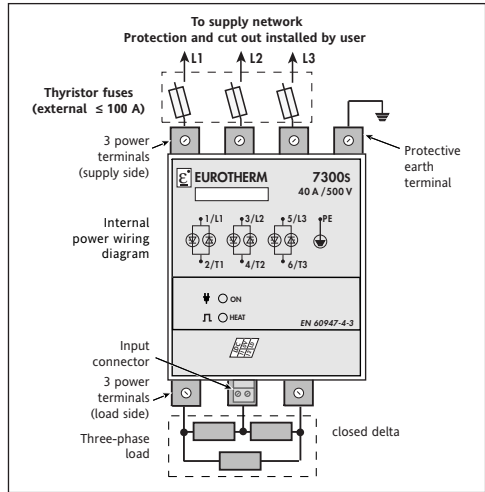

Figure 2-8 Connecting a three-phase load using Closed Delta configuration

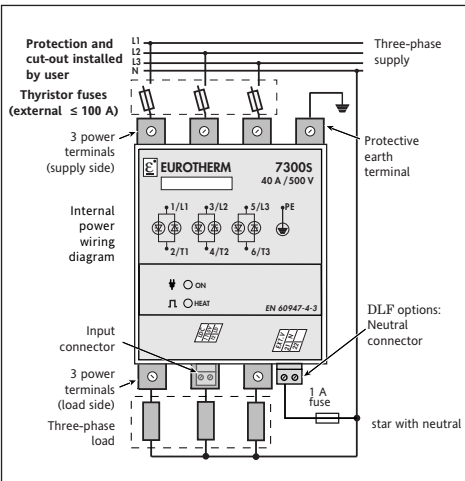

Figure 2-9 Connecting a three-phase load using Star with Neutral configuration

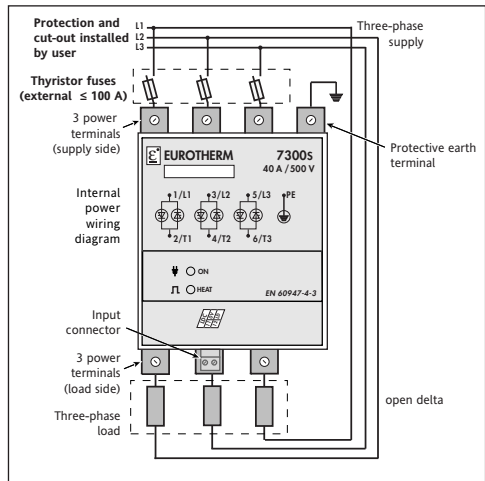

Figure 2-10 Connecting a three-phase load using Open Delta configuration

**Note :** for units  $\geq 125$  A the fuses are internal

### 2.3.3. CONTROL TERMINAL BLOCKS

The control terminal blocks are plug-in screw connectors, located on the **underside** of the solid state contactor

#### 2.3.3.1. Control signal

The control signal input terminal block corresponds to the input type and solid state contactor version selected in the product code. The terminal names and numbers for the corresponding terminal blocks are marked on the front panel.

Input code and type	Terminal block	Terminal number	Terminal reference	Terminal capacity		Torque Nm	Stripping mm
				mm <sup>2</sup>	AWG		
<b>LDC</b> : logic, 4.5 - 32 Vdc	LDC	11 12	0V LD	1.5	16	0.5	6 to 7
<b>HAC</b> : logic, 85 - 253 Vac	HAC	11 12	A1 A2	2.5	14	0.7	6 to 7
<b>ATP</b> : analogue, 4 - 20 mA DC	ATP	11 12	0V RI	1.5	16	0.5	6 to 7

Table 2-4 Description of control input terminal block

#### Important!



- The DC inputs (**LDC** and **ATP**) are polarised.  
The '+' of the control signal must be connected to terminal 12 (labelled **LD** for the LDC input and **RI** for the ATP input).
- If an RC snubber contact protection circuit is used (**HAC** input), the maximum capacitor value is **22 nF** for 240 Vac.  
Increasing this value may lead to continuous firing.

#### 2.3.3.2. Alarm relay contact (option)

If one of the alarm options is fitted, an alarm relay contact is available on the '**ALARM**' terminal block. Contact switching capacity: 0.25 A (maximum 250 Vac or 30 Vdc). The type of contact (closed or open on alarm) is selected on ordering and determines the terminal numbers.

Option code	Terminal block	Terminal number	Terminal reference	Terminal capacity		Torque Nm	Stripping mm
				mm <sup>2</sup>	AWG		
<b>DLF</b> : DLF alarm and serious alarms	ALARM	73, 74	1a, 1b	2.5	14	0.7	6 to 7

Table 2-5 Description of Alarm relay contact terminal block

### 2.3.3.3. Connecting the reference neutral voltage

To enable the **DLF** options to operate with **4S** load configuration, the neutral voltage of the three-phase supply (**reference neutral**) must be applied to terminal **21**, marked **N (EXT)** connector, external voltage).

Terminal capacity: **2.5 mm<sup>2</sup>**; torque **0.7 Nm**.

This connection must be protected by a **1 A** fuse (see figure 2-11).

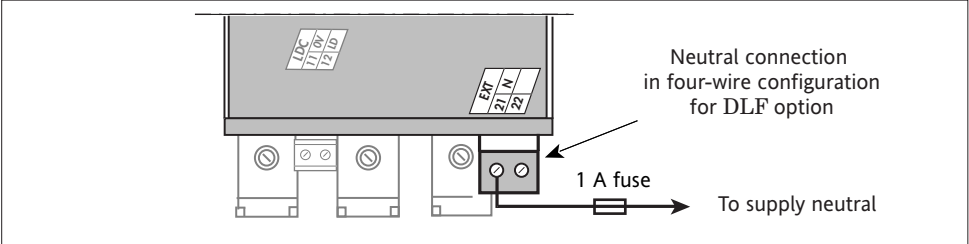

Figure 2-11 Connecting the supply neutral voltage (code 4S and DLF)

### 2.3.3.4. Fan power supply

The fan (current rating 125 A or higher) may be powered at **115 V** or **230 V** depending on the product code.

The fan power supply terminal block (marked '**FAN**') has three terminals (16 to 18). Only one terminal (**16** for 230 V or **17** for 115 V depending on the code) is to be used to connect to a phase of the supply.

Terminal **18** (marked **0V**) must be connected to the neutral of the external supply or to the second phase (if the supply is taken between two phases).

The fan power consumption is approx. 10 VA.

If a supply other than 230 V or 115 V is used, the fan must be powered via a transformer

Terminal capacity: **2.5 mm<sup>2</sup>**; torque **0.7 Nm**.

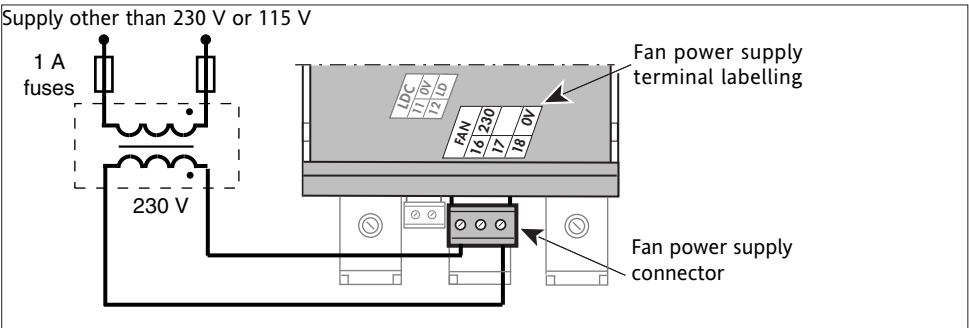

Figure 2-12 Typical fan power supply connection (code 230V, supply other than 230 or 115 V)

### 2.3.3.5. Connecting the digital communication

Digital communication option basic diagram.

Please refer to the 7000 Digital Communication user manual ref : HA176664ENG.

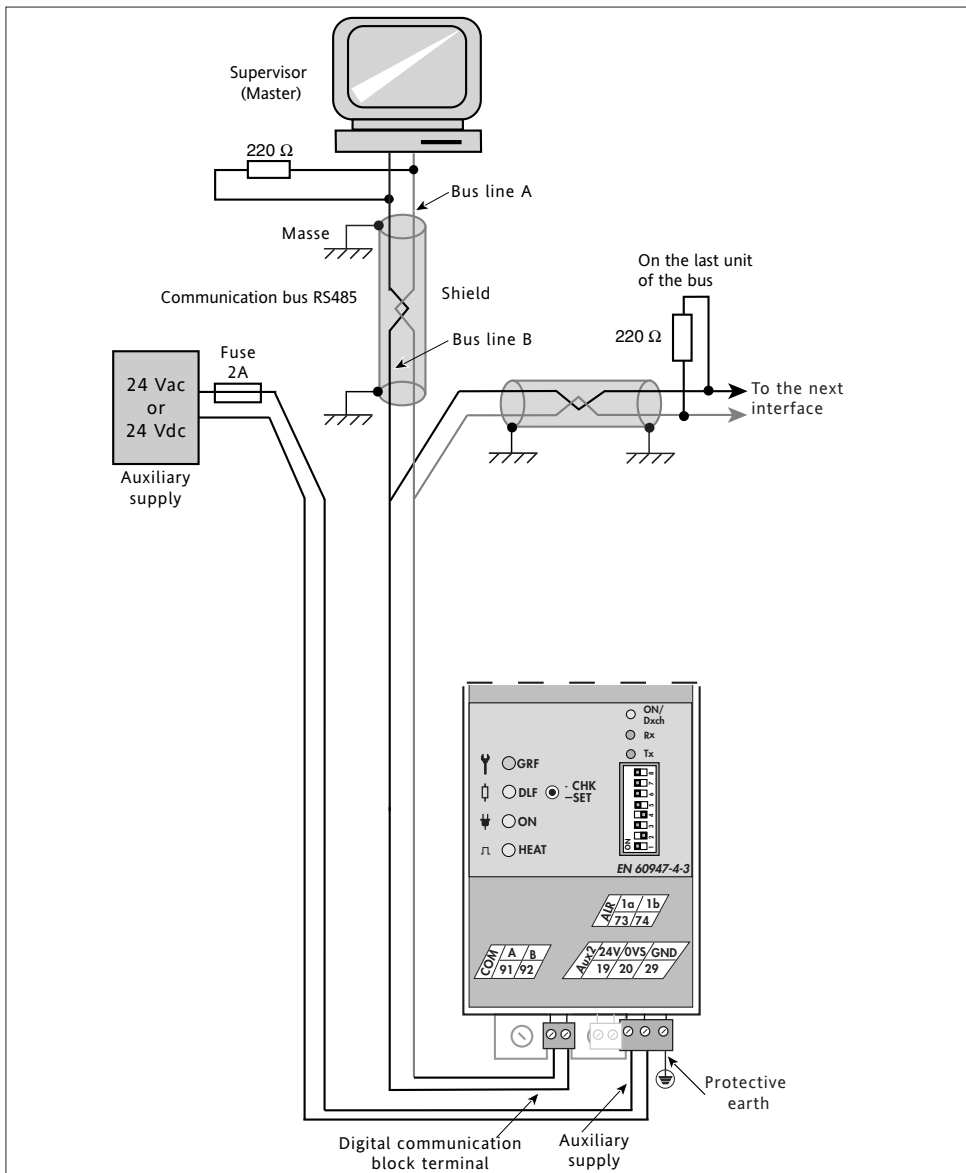

Figure 2-13 Digital communication connection





---

## Chapter 3

### 3. ALARMS (Options)

Contents	Page
<b>Alaram Diagnostic Strategy</b> .....	3-2
<b>3.1. Safety mechanisms</b> .....	3-3
<b>3.2. Alarm Signalling</b> .....	3-3
<b>3.3. Alarm Strategy</b> .....	3-3
<b>3.3.1. Setting DLF alarm</b> .....	3-5
<b>3.3.2. Partial or Total Load failure detection</b> .....	3-5
<b>3.3.3. Partial Load Failure detection sensitivity</b> .....	3-5
<b>3.4. Signalling of channel for load fault</b> .....	3-6
<b>3.5. Load type matching</b> .....	3-6
<b>3.6. Disabling alarm and diagnostic for load failure signalling</b> ....	3-6
<b>3.7. Functions od DLF alarm push button</b> .....	3-7
<b>3.7.1. Setting Request</b> .....	3-7
<b>3.7.2. Diagnosis</b> .....	3-7
<b>3.7.3. Disabling</b> .....	3-7

## ALARM DIAGNOSTIC SUMMARY

The table below summarises all status LED information needed to **diagnose the fault**















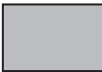
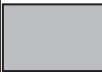

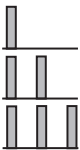





<b>OPTIONS ▶</b> <b>LEDs (Front panel)</b> ▼	<b>Basic Version or options</b>		<b>DLF</b>			
  <b>T°</b> Red (≥ 125 A)						
  <b>GRF</b> Red						
  <b>DLF</b> Orange						
  <b>ON</b> Green						
  <b>HEAT</b> Green						
<b>DIAGNOSIS:</b>	Ready for firing		Firing. No alarms		Over-temperature Firing stopped	
	Ready for firing		Thyristors short-circuit		Total Load Failure on phase or channel indicated	
	Firing. No alarms		Partial Load Failure on phase indicated		Partial Load Failure on phase indicated	

Table 3-1 Diagnosing operation and alarms according to front panel LEDs status

## 3. Chapter 3 ALARMS (Options)

### 3.1. SAFETY MECHANISMS

The alarms on the 7200S solid state contactor, protect the thyristors and the load against certain types of abnormal operation and provide the user with the information about the type of fault.



#### Danger!

- Alarms are not under any circumstances a replacement for personnel protection.
  - The user is responsible for installing independent safety mechanisms which must be inspected regularly. Given the value of the requirement controlled by the 7300S, this is strongly recommended
- Eurotherm can supply various types of suitable alarm detector.

### 3.2. ALARMS SIGNALLING

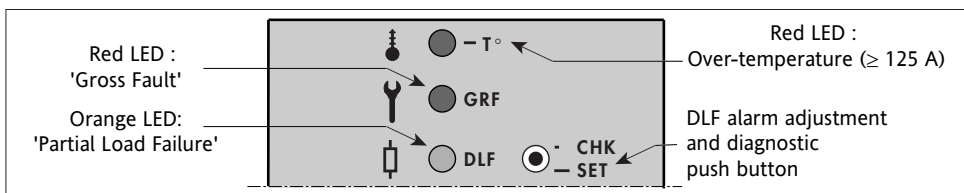

Figure 3-1 Layout of front panel LEDs with 'DfL' option

### 3.3. ALARM STRATEGY

	Description	Signaling
<b>DfL Alarms</b>	Serious Alarm : Total Load Failure TLF, Thyristor Short Circuit THSC, Over-temperature.  Partial Load Failure PLF : monitoring, setting, diagnosing	Alarm Relay Contact & Corresponding LED lit on front panel
<b>Conduction stopped</b>	over-temperature fault detected (fan-cooled products $\geq 125$ A)	Only if one Alarm option has been selected
<b>Alarm Relay</b>	Every alarm change the Alarm Relay Contact position. This contact is : <ul style="list-style-type: none"> <li>• Open on alarm or</li> <li>• Closed on alarm (according to the code)</li> </ul> Cut off alarm contact capacity is 0.25 A (230 Vac or 30 Vdc)	
<b>Memorisation and Reset</b>	No Alarm are memorised. 'Partial Load Failure' signalling can temporarily be out of alarm using the push-button	

Table 3-2 Summary of available alarms

Fault	LED State				Firing stopped	Temps de réaction typique
	'T°' red	'GRF' red	'DLF' orange	'HEAT' green		
Partial Load Failure (PLF)	OFF	OFF	Flashing	ON or Flashing	No	5 s to 13 s
Total Load Failure (TLF)	OFF	ON	Flashing			
Thyristor Short-Circuit (THSC)	OFF	ON	OFF			
Over-temperature (T°)	ON	OFF	OFF	OFF*	Yes	

Table 3-3 LEDs for serious alarms or faults with 'DLF' options

\* Even if the control signal is present.

The indicators for serious alarms detected return to normal (LEDs and relays in non-alarm position) after the fault condition ceases.

#### Important!

- The DLF LED is used to distinguish between TLF or THSC fault.
- The DLF indicator flashes in a particular way to indicate the channel on which the load failure has occurred (see figure 3-2). DLF option with SWIR is not UL approved.
- The red T° LED is only fitted for fan-cooled units (rating  $\geq 125$  A) and if one of the alarm options is selected..

### 3.3.1. Setting the DLF alarm

Adjusting PLF detection involves calculating and storing the value of the reference impedance from the measured rms current and voltage values.

This can be set using the push button on the front panel. The PLF detection setting can only be adjusted (reference impedance recalculated) in the following conditions :

- rms voltage across load is greater than **40 %** of the nominal voltage
- rms current is greater than **30%** of the rated current
- no over-temperature or thyristor short-circuit faults.
- each time PLF setting is required the three-phase load must be balanced.
- in order to guarantee the full scale sensitivity, settings must be done at the load's nominal temperature

Note : PLF settings stay memorised even if a supply cut-out occurred

### 3.3.2. Partial or Total Load Failure Detection

**Partial Load Failure PLF** monitoring involves comparing the load impedance with a reference impedance stored during setting. This comparison allows the detection of the load impedance increase. The load impedance is calculated from the continuous measure of the rms values of current and voltage.

PLF detection is only possible under the following conditions :

- no over-temperature or thyristor short-circuit faults.
- rms voltage across the load greater than **40%** of the nominal voltage and,
- rms load current greater than **5%** of the rated current.

**Total Load Failure TLF** monitoring is only possible under the following conditions :

- no over-temperature or thyristor short-circuit faults.
- the rms voltage across load is greater than **40 %** of the nominal voltage

### 3.3.3. Partial Load Failure Detection Sensitivity

Partial Load Failure Detection Sensitivity can be expressed in terms of a **maximum number** of load elements connected in parallel for which the unit can detect the failure of one element. The DLF sensitivity guaranteed for identical three-phase loads connected in parallel is :

3D coupling - 1 element out of 3

3S, 4S and 6D coupling - 1 element out of 4

### 3.4. SIGNALLING OF CHANNEL FOR LOAD FAILURE

With the DLF option, the DLF LED flashes in particular ways to indicate the number of controlled channel (of the two thyristor channels) on which load failure (TLF or PLF) has occurred.

Figure 4-3 shows the three types of flashing if a load failure is detected on one of the channels of the 7300S solid state contactor.

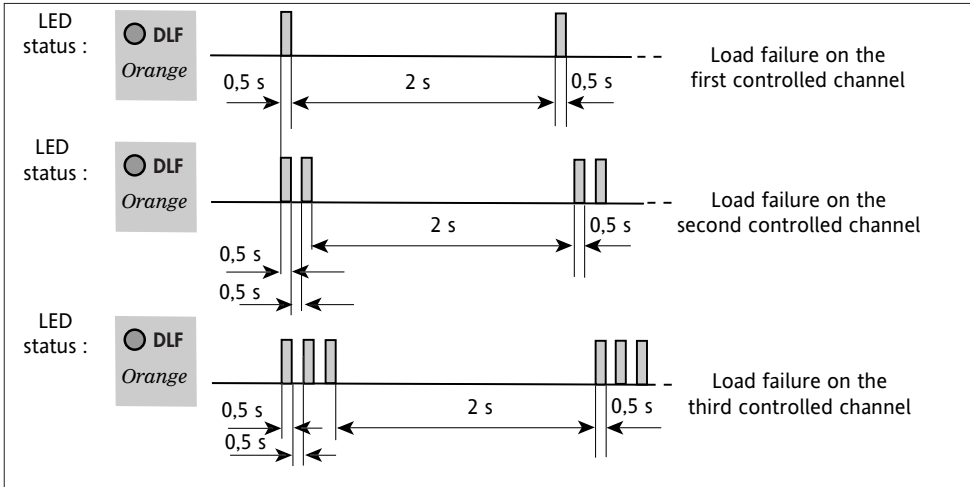

Figure 3-2 Signalling of channel for load failure on the DLF LED

#### Important !

- The number of times the DLF LED flashes indicates the thyristor channel number connected to the failed load phase.
- In 3S three-phased load configuration, the load phase connected to the channel indicated by the DLF LED has failed..
- In 3D three-phased load configuration, on one (or two) branch(es) of the delta connected to the channel indicated by the DLF LED has failed.

### 3.5. LOAD TYPE MATCHING

PLF detection is adapted to the load type.

The type of load controlled is selected when ordering, with the product code :

- **LTCL** (Low Temperature Coefficient Load) or
- **SWIR** (Short Wave InfraRed)

### 3.6. DISABLING ALARMS AND DIAGNOSTICS FOR LOAD FAILURE SIGNALLING

PLF fault signalling (DLF indicator and relay) can be temporarily excluded from alarms, in order to diagnose the presence of the fault and the monitoring status, by pressing the 'CHK / SET' (Check / Setting) push button.

If the fault persists, DLF signalling returns to the alarm position.

### 3.7. FUNCTIONS OF DLF ALARM PUSH BUTTON

The push button on the front panel of the unit with the DLF option is labelled : «CHK / SET» («Checking / Setting»).

Pushing this push button as shown on the timing diagrams below, sets and diagnoses the status of the PLF detection circuit..

#### 3.7.1. Setting request

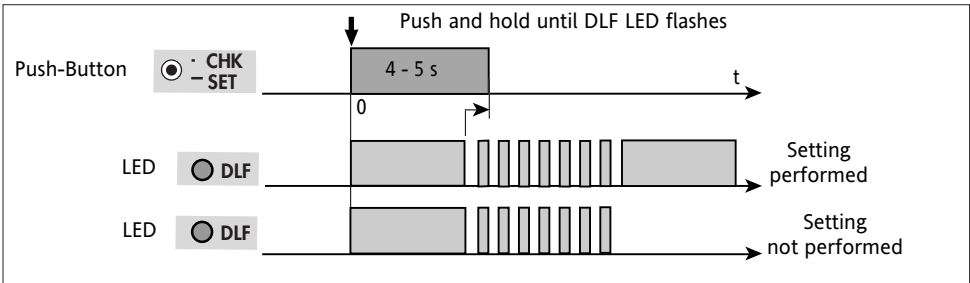

Figure 3-3a PLF detection setting request

#### 3.7.2. Diagnosis

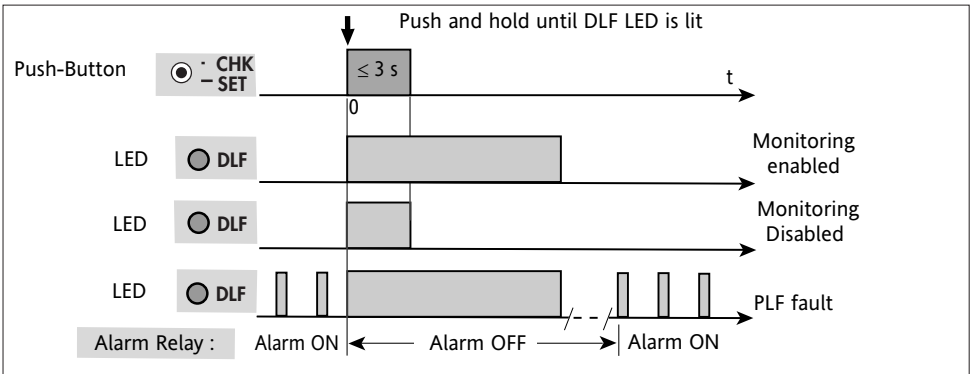

Figure 3-3b PLF monitoring diagnosis

#### 3.7.3. Disabling

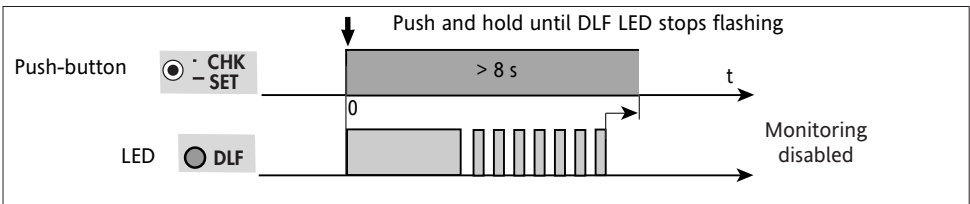

Figure 3-3c Disabling PLF monitoring





## Chapter 4

### 4. COMMISSIONING AND MAINTENANCE

Contents	Page
4.1. Safety during commissioning and maintenance .....	4-2
4.2. Commissioning .....	4-2
4.2.1. Checking the characteristics .....	4-2
4.2.1.1. Load current .....	4-2
4.2.1.2. Supply voltage .....	4-2
4.2.1.3. Input signal .....	4-2
4.2.1.4. Load Type (DLF Option) .....	4-2
4.2.2. Checking wiring .....	4-3
4.2.2.1. Cut-off and isolation systems .....	4-3
4.2.2.2. Protective earth, power and control connections ..	4-3
4.2.3. Power up .....	4-3
4.2.3.1. Power and auxiliary voltages and input signal ...	4-3
4.2.3.2. Adjust the partial load failure detection setting ..	4-3
4.3. Maintenance .....	4-4
4.4. Thyristor protection fuses .....	4-4

## 4. Chapter 4 COMMISSIONING AND MAINTENANCE

### 4.1. SAFETY DURING COMMISSIONING AND MAINTENANCE

Please read carefully before commissioning the unit

**Important!**



- Eurotherm shall not be held responsible for any damage, injury, losses or expenses incurred by inappropriate use of the product or failure to comply with this manual.
- Accordingly the user is responsible for checking, before commissioning the unit, that all the nominal characteristics correspond to the conditions under which it is to be installed and used.

**Danger!**



- The product must be commissioned and maintained by qualified personnel, authorised to work in an industrial low voltage environment. Users must not attempt to access internal parts. The heatsink temperature may exceed 100°C. The heatsink remains hot for approx. 15 minutes after the unit is shut down. Avoid touching the heatsink even briefly while the unit is operating.

### 4.2. COMMISSIONING

#### 4.2.1. CHECKING THE CHARACTERISTICS



Before powering up the unit, check that the **identification code** corresponds to the code specified on the order and that the characteristics are **compatible** with the facility.

##### 4.2.1.1. Load current

The maximum load current must be less than or equal to the nominal current value of the solid state contactor, taking account of supply and load variations.

##### 4.2.1.2. Supply voltage

The nominal voltage value must be greater than or equal to the line-to-line or line-to-neutral supply voltage (depending on the connection scheme).



Never use the unit on a supply with a voltage greater than the nominal value +10% as this could damage the protection components or even the thyristors.

##### 4.2.1.3. Input signal

The signal type is factory configured depending on the option ordered. Check that the signal used corresponds to the input type indicated on the front panel of the unit (LDC, HAC or ATP).

##### 4.2.1.4. Load Type (DLF Option)

For correct operation of the partial load failure detection system, ensures that load type used corresponds to the product code (LTCL or SWIR).

## 4.2.2. CHECKING THE WIRING

### 4.2.2.1. Cut-off and isolation systems

It is the user's responsibility to wire and protect the facility according to best practice and applicable standards.



**Danger!**

A suitable device ensuring that the unit can be electrically isolated from the supply must be installed upline to enable work to be performed safely.

### 4.2.2.2. Protective earth, power and control connections

- Before checking the wiring, ensure that the power and control wires are **isolated** from power sources.
- Check that the **protective earth** cable is connected to the earth terminal on the unit.
- Check that the **wiring** corresponds to the connection diagram (figure 2-5 for ratings up to 100 A and figure 2-6 for ratings of 125 A and above).
- for ratings of 125 A or more, check that the **reference voltage** is connected to terminal **L2** on the **EXT** terminal block (figure 2-11).
- For fan-cooled units (125 A and above) check the **fan** power supply (voltage, connections and fuse).
- Check the **polarity** of DC input signals (code **LDC** or **ATP**) Table 2-4.

## 4.2.3. POWER UP

### 4.2.3.1. Power and auxiliary voltages and input signal

- Check that there is no input signal then power up the unit.  
Check that there is no current in the load.
- Check the auxiliary voltage for **COM** options (**Aux2** terminal block) see page 2-11.
- Apply the logic signal (**LDC** or **HAC** inputs) for a short period or the analogue signal with a low value (**ATP** input) and check that the load current appears and the 'HEAT' LED is lit during firing.
- Apply the necessary input signal.

### 4.2.3.2. Adjust the partial load failure detection setting (DLF option).

- Check that the DLF alarm operating conditions are correct and that the load failure detection conditions are met (page 3-5).
- The partial load failure detection settings are adjusted with the **push button** on the front panel of units fitted with the DLF option. The procedure and conditions for this setting are described the 'DLF option' section in (page 3-7).

### 4.3. MAINTENANCE

- Every six months, check that the power and protective earth cables are correctly **tightened**.
- If the load parameters **change**, the operation of the PLF detection must be diagnosed (see 'DLF option' section - chapter 3).
- If a **DLF alarm** occurs, check the load wiring and condition of contacts. Use the push button to **confirm** the DLF alarm **diagnosis**.
- To ensure that the unit is cooled correctly, the heatsink should be **cleaned** regularly, depending on how dirty the environment is, as should the fan protection grille for fan-cooled units rated at 125 A or more.

**Danger!**

Power down the unit before cleaning and allow 15 minutes for it to cool down.

### 4.4. THYRISTOR PROTECTION FUSES

A **high speed fuse** protects the thyristors in the 7300S unit against excessive current. For current ratings up to **100 A** the fuses are **external**.

For current ratings of **125 A** and above the fuses are **internal**, located in a special compartment, under a cover held by two captive screws.

**Danger!**

High-speed fuses **do not** provide protection for the installation. Upline protection must be fitted (non-high-speed fuses, circuit breakers).

If the 'Fuse' field of the product code is '**NONE**' (i.e. the user did not order a thyristor protection fuse or the load comprises short wave infrared elements), the fuse is **not supplied** (ratings **16 A** to **100 A**) or is **not installed** inside the unit (ratings **125 A** and over).

**Important!**

For all loads (other than short wave infrared elements), using a thyristor protection fuse **other** than the recommended fuses listed in the tables below **voids** the product guarantee.

An **external** high speed fuse protects the thyristors in 7300S units with a current rating of 16 A to 100 A.

An **internal** high speed fuse protects the thyristors in 7300S units with a current rating of 125 A to 160 A.

The **product code** indicates whether a fuse is included in the unit ordered and the type of fuse. With the **FUSE** or **MSFU** (**M**icro **S**witch **F**Use) codes, a fuse and fuse holder assembly (corresponding to the current rating) is supplied with the product.

- **FUSE** code: the fuse does not have a fuse blown striker bar
- **MSFU** code: the fuse has a striker bar and the fuse holder is fitted with a blown fuse microswitch to be connected by the customer.

Rating	A fuse part number	Fuses and fuse-holder assembly			
		Part number	Dimensions (mm)		
			H	W	D
16A	CH260034	FU3038/16A	77	54	61
25A	CH260034	FU3038/25A	77	54	61
40A	CH330054	FU3451/40A	106	78	76
63A	CS173087U080	FU3258/63A	124	104	76
80A	CS173087U100	FU3258/80A	124	104	76
100A	CS173246U160	FU3760/100A	146	120	94

Table 4-1 Tripolar Fuses **without microswitch**, recommended for rating 16 A to 100 A (code **FUSE**)

Rating	A fuse part number	Fuses and fuse-holder assembly			
		Part number	Dimensions (mm)		
			H	W	D
16A	CS176513U032	MSFU3451/16A	77	54	61
25A	CS176513U032	MSFU3451/25A	77	54	61
40A	CS176513U050	MSFU3451/40A	106	78	76
63A	CS176461U080	MSFU3258/63A	124	104	76
80A	CS176461U100	MSFU3258/80A	124	104	76
100A	CS173246U160	MSFU3760/100A	146	120	94

Table 4-2 Tripolar Fuses **with microswitch**, recommended for rating 16 A to 100 A (code **MSFU**)

Rating	Fuse part number with or without fuse-holder assembly internal fuse
125A	CS176762U160
160A	CS176762U315

Table 4-3 Unipolar fuses recommended for rating  $\geq 125$  A

**Note :** Thyristor protection is achieved with one external tripolar fuse and fuse-holder for 7300S units  $\leq 100$ A.

**Important!**

For all loads (other than short wave infrared elements), using a thyristor protection fuse **other than** the recommended fuse **voids** the product guarantee.

---

# EUROTHERM LIMITED

For over thirty years **Eurotherm Limited** have been providing an unparalleled level of service and expertise to customers in the control of Processes and Power.

From requirement assessment, through to equipment specification and plant commissioning.

**Eurotherm Limited** is able to offer expertise and equipment in the following areas:

- Input conditioning
- Process and Temperature Indicators
- Single Loop Process and Temperature Controllers with Programming facilities
- Programmable Multi loop Process Controllers
- Solid State Contactors
- Power Controllers
- Paper and Paperless Data Recorders
- Data Acquisition and Management Instrumentation
- Supervisory Systems (SCADA)
- Process Automation Systems

**Eurotherm** manufactures at a number of locations in Europe and the USA, and is a major supplier to the world's processing and manufacturing industries.

**Eurotherm Limited** is ISO9001 approved and operates TickIT protocols for software management.

Please contact your local **Sales Office**.



# Eurotherm : International Sales and Service

## **AUSTRALIA** Melbourne

Invensys Process Systems  
Australia Pty. Ltd.

**T** (+61 0) 8562 9800

**F** (+61 0) 8562 9801

**E** [info.eurotherm.au@invensys.com](mailto:info.eurotherm.au@invensys.com)

## **AUSTRIA** Vienna

Eurotherm GmbH

**T** (+43 1) 7987601

**F** (+43 1) 7987605

**E** [info.eurotherm.at@invensys.com](mailto:info.eurotherm.at@invensys.com)

## **BELGIUM & LUXEMBOURG**

Moha

Eurotherm S.A./N.V.

**T** (+32) 85 274080

**F** (+32) 85 274081

**E** [info.eurotherm.be@invensys.com](mailto:info.eurotherm.be@invensys.com)

## **BRAZIL** Campinas-SP

Eurotherm Ltda.

**T** (+5519) 3707 5333

**F** (+5519) 3707 5345

**E** [info.eurotherm.br@invensys.com](mailto:info.eurotherm.br@invensys.com)

## **CHINA**

Eurotherm China

**T** (+86 21) 61451188

**F** (+86 21) 61452602

**E** [info.eurotherm.cn@invensys.com](mailto:info.eurotherm.cn@invensys.com)

Beijing Office

**T** (+86 10) 5909 5700

**F** (+86 10) 5909 5709/10

**E** [info.eurotherm.cn@invensys.com](mailto:info.eurotherm.cn@invensys.com)

## **FRANCE** Lyon

Eurotherm Automation SA

**T** (+33 478) 664500

**F** (+33 478) 352490

**E** [info.eurotherm.fr@invensys.com](mailto:info.eurotherm.fr@invensys.com)

## **GERMANY** Limburg

Invensys Systems GmbH

>EUROTHERM<

**T** (+49 6431) 2980

**F** (+49 6431) 298119

**E** [info.eurotherm.de@invensys.com](mailto:info.eurotherm.de@invensys.com)

## **INDIA** Mumbai

Invensys India Pvt. Ltd.

**T** (+91 22) 67579800

**F** (+91 22) 67579999

**E** [info.eurotherm.in@invensys.com](mailto:info.eurotherm.in@invensys.com)

## **IRELAND** Dublin

Eurotherm Ireland Limited

**T** (+353 1) 4691800

**F** (+353 1) 4691300

**E** [info.eurotherm.ie@invensys.com](mailto:info.eurotherm.ie@invensys.com)

## **ITALY** Como

Eurotherm S.r.l.

**T** (+39 031) 975111

**F** (+39 031) 977512

**E** [info.eurotherm.it@invensys.com](mailto:info.eurotherm.it@invensys.com)

## **KOREA** Seoul

Invensys Operations Management  
Korea

**T** (+82 2) 2090 0900

**F** (+82 2) 2090 0800

**E** [info.eurotherm.kr@invensys.com](mailto:info.eurotherm.kr@invensys.com)

## **NETHERLANDS** Alphen a/d Rijn

Eurotherm B.V.

**T** (+31 172) 411752

**F** (+31 172) 417260

**E** [info.eurotherm.nl@invensys.com](mailto:info.eurotherm.nl@invensys.com)

## **POLAND** Katowice

Invensys Eurotherm Sp z o.o.

**T** (+48 32) 7839500

**F** (+48 32) 7843608/7843609

**E** [info.eurotherm.pl@invensys.com](mailto:info.eurotherm.pl@invensys.com)

Warsaw

Invensys Systems Sp z o.o.

**T** (+48 22) 8556010

**F** (+48 22) 8556011

**E** [biuro@invensys-systems.pl](mailto:biuro@invensys-systems.pl)

## **SPAIN** Madrid

Eurotherm España SA

**T** (+34 91) 6616001

**F** (+34 91) 6619093

**E** [info.eurotherm.es@invensys.com](mailto:info.eurotherm.es@invensys.com)

## **SWEDEN** Malmo

Eurotherm AB

**T** (+46 40) 384500

**F** (+46 40) 384545

**E** [info.eurotherm.se@invensys.com](mailto:info.eurotherm.se@invensys.com)

## **SWITZERLAND** Wollerau

Eurotherm Produkte (Schweiz) AG

**T** (+41 44) 7871040

**F** (+41 44) 7871044

**E** [info.eurotherm.ch@invensys.com](mailto:info.eurotherm.ch@invensys.com)

## **UAE DUBAI**

Invensys Middle East FZE

**T** (+971 4) 8074700

**F** (+971 4) 8074777

**E** [marketing.mena@invensys.com](mailto:marketing.mena@invensys.com)

## **UNITED KINGDOM** Worthing

Eurotherm Limited

**T** (+44 1903) 268500

**F** (+44 1903) 265982

**E** [info.eurotherm.uk@invensys.com](mailto:info.eurotherm.uk@invensys.com)

## **U.S.A.** Ashburn VA

Invensys Eurotherm

**T** (+1 703) 724 7300

**F** (+1 703) 724 7301

**E** [info.eurotherm.us@invensys.com](mailto:info.eurotherm.us@invensys.com)

ED68

© Copyright Eurotherm Automation 2003

All rights reserved. All reproduction or transmission in any form whatsoever and using any procedure (electronic or mechanical, including photocopying and recording) without written permission from Eurotherm is strictly prohibited.

Represented by:

i n v e n s y s  
Eurotherm