

Altivar 61/71

Variable speed drives
for synchronous and asynchronous motors

PROFINET[®] Communication Manual VW3A3327

01/2014

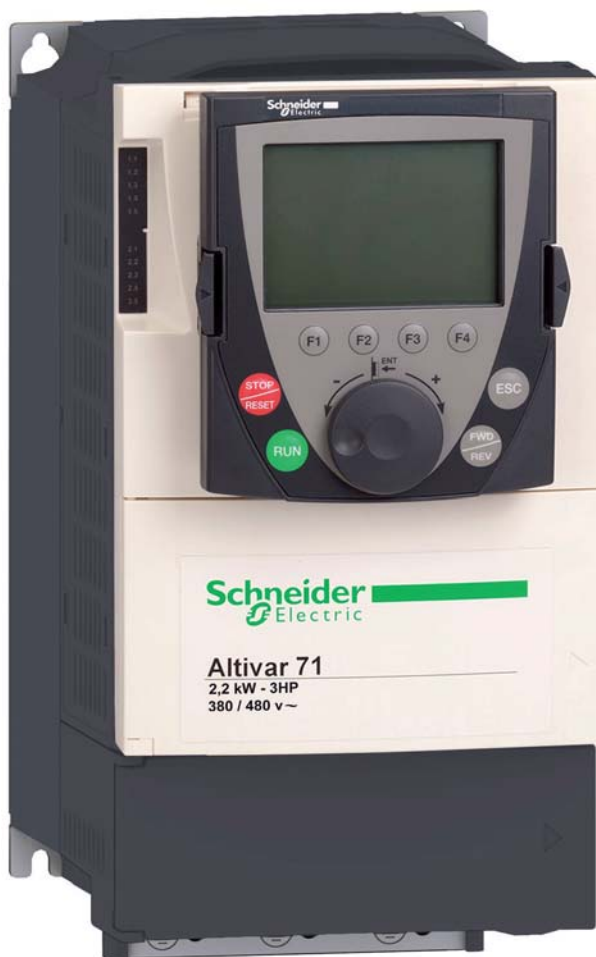

The information provided in this documentation contains general descriptions and/or technical characteristics of the performance of the products contained herein. This documentation is not intended as a substitute for and is not to be used for determining suitability or reliability of these products for specific user applications. It is the duty of any such user or integrator to perform the appropriate and complete risk analysis, evaluation and testing of the products with respect to the relevant specific application or use thereof. Neither Schneider Electric nor any of its affiliates or subsidiaries shall be responsible or liable for misuse of the information contained herein. If you have any suggestions for improvements or amendments or have found errors in this publication, please notify us.

No part of this document may be reproduced in any form or by any means, electronic or mechanical, including photocopying, without express written permission of Schneider Electric. All pertinent state, regional, and local safety regulations must be observed when installing and using this product. For reasons of safety and to help ensure compliance with documented system data, only the manufacturer should perform repairs to components.

When devices are used for applications with technical safety requirements, the relevant instructions must be followed.

Failure to use Schneider Electric software or approved software with our hardware products may result in injury, harm, or improper operating results.

Failure to observe this information can result in injury or equipment damage.

© 2013 Schneider Electric. All rights reserved.

Table of Contents

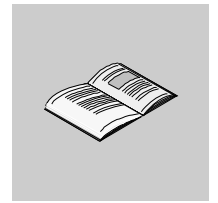

	Safety Information	5
	About the Book	6
Chapter 1	Altivar PROFINET Overview	9
	Overview	10
	PROFINET communication Card Features Overview	10
	PROFINET	11
	Modbus TCP	11
	PROFINET and Ethernet Features	11
	Webserver	11
	Notation rules in this manual	11
Chapter 2	Hardware Setup	13
	Hardware Presentation	14
	Firmware and GSDML Version Compatibility	14
	Installation	14
	Wiring	16
	Installation Topology	17
Chapter 3	Configuration and Parameters	19
	Network Settings	20
	iPar Settings	22
	Modbus TCP Settings	23
Chapter 4	Configuration	25
	Configuring the Control Channel	26
	Configuring Monitor Parameters	29
	Configuring Communication Interruption Management	30
Chapter 5	Diagnostics and monitoring	31
	LED Indicators	32
	Communication Diagnostics	34
	Monitoring of communication Channels	36
	Control-Signal Diagnostics	38
Chapter 6	Telegram 100	41
	Overview	42
	Configuring an ATV61/71 With a Siemens® S7-300	44
	Configuration of the Altivar 61/71 With the Telegram 100	45
	Parameters Management With the telegram 100	47
Chapter 7	Telegram 1	49
	Overview	50
	State Diagram	51
	Command Word and Status Word	52
	Speed Setpoint	55
	PROFIdrive / Acyclic Messaging	55
Chapter 8	Embedded Webserver	57
	Overview	58
	Connection to the Webserver	58

	Pages Description	59
	FTP SERVER	65
Chapter 9	Common Additional Features	67
	Identification and Maintenance Data	68
	I&M Records Description	68
Chapter 10	Annexes	69
	Annex A - Simple CONT Language FC (Controlling the Drive in CiA402 Mode)	70
	Annex B - The PROFIdrive Parameters Channel	75
	Annex C - iPar Service	80
	Glossary	82

Safety Information

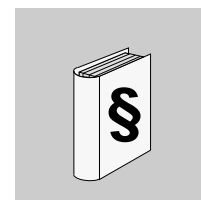

Important Information

NOTICE

Read these instructions carefully, and look at the equipment to become familiar with the device before trying to install, operate, or maintain it. The following special messages may appear throughout this documentation or on the equipment to warn of potential hazards or to call attention to information that clarifies or simplifies a procedure.



The addition of this symbol to a Danger or Warning safety label indicates that an electrical hazard exists, which will result in personal injury if the instructions are not followed.



This is the safety alert symbol. It is used to alert you to potential personal injury hazards. Obey all safety messages that follow this symbol to avoid possible injury or death.

▲ DANGER

DANGER indicates an imminently hazardous situation, which, if not avoided, **will result** in death or serious injury.

▲ WARNING

WARNING indicates a potentially hazardous situation, which, if not avoided, **can result** in death, serious injury or equipment damage.

▲ CAUTION

CAUTION indicates a potentially hazardous situation, which, if not avoided, **can result** in injury or equipment damage.

NOTICE

NOTICE, used without the safety alert symbol, indicates a potentially hazardous situation which, if not avoided, **can result** in equipment damage.

PLEASE NOTE

The word "drive" as used in this manual refers to the controller portion of the adjustable speed drive as defined by NEC.

Electrical equipment should be installed, operated, serviced, and maintained only by qualified personnel. No responsibility is assumed by Schneider Electric for any consequences arising out of the use of this product.

© 2013 Schneider Electric. All Rights Reserved.

About the Book

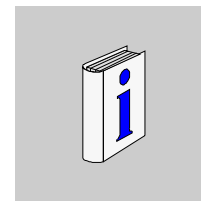

Document Scope

The purpose of this document is to:

- show you how to install the PROFINET communication module on your Altivar,
- show you how to configure the Altivar to use PROFINET fieldbus

NOTE: Read and understand this document and all related documents (see below) before installing, operating, or maintaining your ATV61/71.

Validity Note

This documentation is valid for the Altivar 61/71 PROFINET fieldbus.

Related Documents

Title of Documentation	Reference Number
ATV61 Quick Start guide	S1B86974
ATV71 Quick Start guide	S1B86982
ATV61 > 75kW Installation manual	1760655
ATV71 > 75kW Installation manual	1755849
ATV61 0,37kW to 75 kW Installation manual	1760643
ATV71 0,37kW to 75 kW Installation manual	1755843
ATV61 Programming manual	1760649
ATV71 Programming manual	1755855
ATV71 S383 Programming manual	AAV49426
ATV71 Communication Parameters manual	1755861
ATV61 Communication parameters manual	1760661
ATV71 Integrated Modbus manual	1755863
ATV71 Modbus Plus manual	1755869
ATV71 Uni-Telway manual	1755867
ATV71 Modbus with Uni-Telway manual	1755875
ATV61/71 CC-Link manual	AAV49429
ATV61/71 Standard Fipio manual	1755883
ATV61 LonWorks card manual	1765273
ATV61 BACnet manual	1765274
ATV61/71 DeviceNet manual	1755877
ATV61 Metasys N2 manual	AAV33578
ATV61 APOGEE FLN P1 manual	BBV10543
ATV61/71 INTERBUS manual	1755871
ATV61/71 Profibus DP manual	1755873
ATV61/71 Profibus DPv1 manual	AAV52935
ATV61/71 Controller Inside manual	1757062
ATV61/71 CANopen manual	1755865
ATV61/71 EtherNet-IP manual	AAV68822
ATV61/71 Ethernet - Modbus TCP-IP manual	1755879
ATV61/71 Modbus TCP-IP manual - Daisy Chain Ethernet card manual	AAV69931
ATV61/71 ModbusTCP manual_VW3A3320	HRB10064
ATV61/71 EthernetIP manual VW3A3320	HRB10065
ATV61/71 LIFT Safety integrated function manual	S1A91443
ATV61/71 certificates, see www.schneider-electric.com	

You can download the latest versions of these technical publications and other technical information from www.schneider-electric.com.

User Comments

We welcome your comments about this document.

You can reach us by e-mail at techpub.drives@schneider-electric.com.

Product related information

⚠ DANGER

UNINTENDED EQUIPMENT OPERATION

- Read and understand this manual before installing or operating the Altivar 32 drive.
- Any changes made to the parameter settings must be performed by qualified personnel.

Failure to follow these instructions will result in death or serious injury.

⚠⚠ DANGER

HAZARD OF ELECTRIC SHOCK, EXPLOSION, OR ARC FLASH

- Only appropriately trained persons who are familiar with and understand the contents of this manual and all other pertinent product documentation and who have received safety training to recognize and avoid hazards involved are authorized to work on and with this drive system. Installation, adjustment, repair and maintenance must be performed by qualified personnel.
- The system integrator is responsible for compliance with all local and national electrical code requirements as well as all other applicable regulations with respect to grounding of all equipment.
- Many components of the product, including the printed circuit boards, operate with mains voltage. Do not touch. Use only electrically insulated tools.
- Do not touch unshielded components or terminals with voltage present.
- Motors can generate voltage when the shaft is rotated. Prior to performing any type of work on the drive system, block the motor shaft to prevent rotation.
- AC voltage can couple voltage to unused conductors in the motor cable. Insulate both ends of unused conductors of the motor cable.
- Do not short across the DC bus terminals or the DC bus capacitors or the braking resistor terminals.
- Before performing work on the drive system:
 - Disconnect all power, including external control power that may be present.
 - Place a "Do Not Turn On" label on all power switches.
 - Lock all power switches in the open position.
 - Wait 15 minutes to allow the DC bus capacitors to discharge. The DC bus LED is not an indicator of the absence of DC bus voltage that can exceed 800 Vdc.
 - Measure the voltage on the DC bus between the DC bus terminals using a properly rated voltmeter to verify that the voltage is < 42 Vdc.
 - If the DC bus capacitors do not discharge properly, contact your local Schneider Electric representative.
- Install and close all covers before applying voltage.

Failure to follow these instructions will result in death or serious injury.

Failure to follow these instructions will result in death or serious injury.

⚠ WARNING

DAMAGE DRIVE EQUIPMENT

Do not operate or install any drive or drive accessory that appears damaged.

Failure to follow these instructions can result in death, serious injury, or equipment damage.

▲ WARNING**LOSS OF CONTROL**

- The designer of any control scheme must consider the potential failure modes of control paths and, for critical control functions, provide a means to achieve a safe state during and after a path failure. Examples of critical control functions are emergency stop, overtravel stop, power outage, and restart.
- Separate or redundant control paths must be provided for critical control functions.
- System control paths may include communication links. Consideration must be given to the implications of unanticipated transmission delays or failures of the link.
- Observe all accident prevention regulations and local safety guidelines.(1)
- Each implementation of the product must be individually and thoroughly tested for proper operation before being placed into service.

Failure to follow these instructions can result in death, serious injury, or equipment damage.

(1) For USA: Additional information, refer to NEMA ICS 1.1 (latest edition), "Safety Guidelines for the Application, Installation, and Maintenance of Solid State Control" and to NEMA ICS 7.1 (latest edition), "Safety Standards for Construction and Guide for Selection, Installation and Operation of Adjustable Speed Drive Systems."

Altivar PROFINET Overview



What Is in this Chapter?

This chapter contains the following topics:

Topic	Page
Overview	10
PROFINET communication Card Features Overview	10
PROFINET	11
Modbus TCP	11
PROFINET and Ethernet Features	11
Webserver	11
Notation rules in this manual	11

Overview

The VW3A3327 is a dual port PROFINET communication card that can be used in a PROFINET industrial fieldbus. The VW3A3327 also offers an embedded web server (5 languages) which offers comfortable monitoring and commissioning functions directly from a standard web browser.

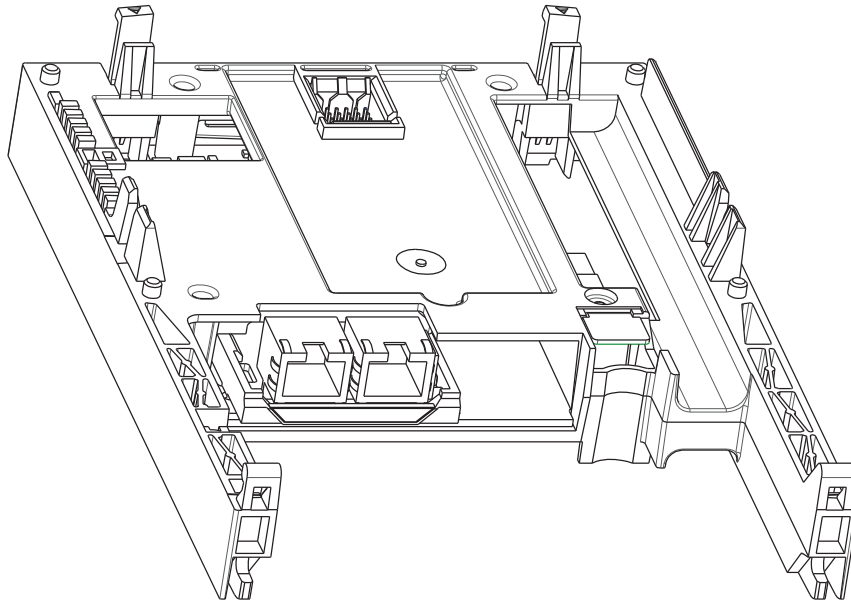

Basic Overview According to the Simplified TCP/IP Model

Application	PROFINET / IP Services	PROFINET RT
Transport	TCP/UDP	–
Network	IP	–
Link	Ethernet	Ethernet

PROFINET communication Card Features Overview

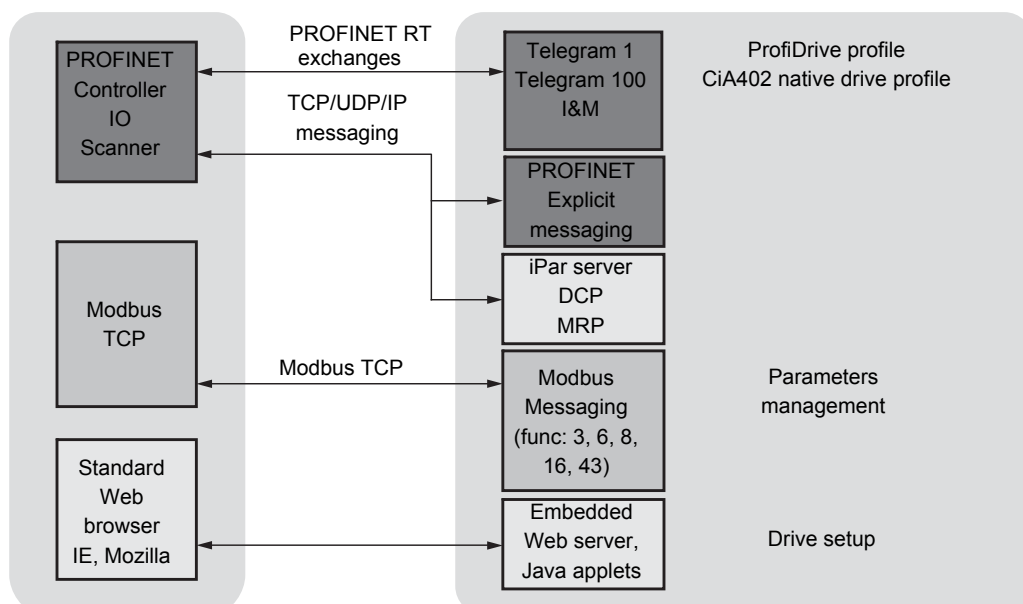

PROFINET

PROFINET RT extends Ethernet by an advanced industrial protocol management as an application layer for automation applications in this way, Ethernet is excellently suited for industrial control. PROFINET relies on TCP and UDP for non-RT informations. Products from different manufacturers can be networked by using a PROFINET compliant switch.

Modbus TCP

The Modbus application layer is standard. Thousands of manufacturers are already implementing this protocol. Many have already developed a Modbus TCP/IP connection and numerous products are currently available. With the simplicity of its protocol and the fast Ethernet throughput data rate of 100 Mbps, Modbus TCP/IP achieves excellent performance.

PROFINET and Ethernet Features

The product supports the following functions:

- Automatic IP address assignment via DHCP and DCP
- Support of MRP (Media Redundancy Protocol)
- Automatic configuration data via iPar-Server
- Commissioning via commissioning SoMove software
- Support of LLDP (Link Layer Discovery Protocol) available with the version \geq V1.3IE02
- Diagnostics and configuration via integrated web server

Webserver

The standard web server provides access to the following pages:

- Drive monitor
- Data viewer/editor
- Save and restore configuration
- Network parameters
- iPar client settings
- Administration
- TCP/UIP statistics
- Modbus statistics

Notation rules in this manual

Drive Terminal Displays

The graphic display terminal (to be ordered separately - reference VW3A1101) menus are shown in square brackets.

Example: **[COMMUNICATION]**

The integrated 7-segment display terminal menus are shown in round brackets.

Example: **(C D n -)**

Parameter names are displayed on the graphic display terminal in square brackets.

Example: **[Fallback speed]**

Parameter codes are displayed on the integrated 7-segment display terminal in round brackets.

Example: **(L F F)**

Formats

In this manual, hexadecimal values are written as follows: 16#

Binary values are written as follow: 2#

Hardware Setup



2

What Is in this Chapter?

This chapter contains the following topics:

Topic	Page
Hardware Presentation	14
Firmware and GSDML Version Compatibility	14
Installation	14
Wiring	16
Installation Topology	17

Hardware Presentation

The following figure shows the dual RJ45 connector, PROFINET module:

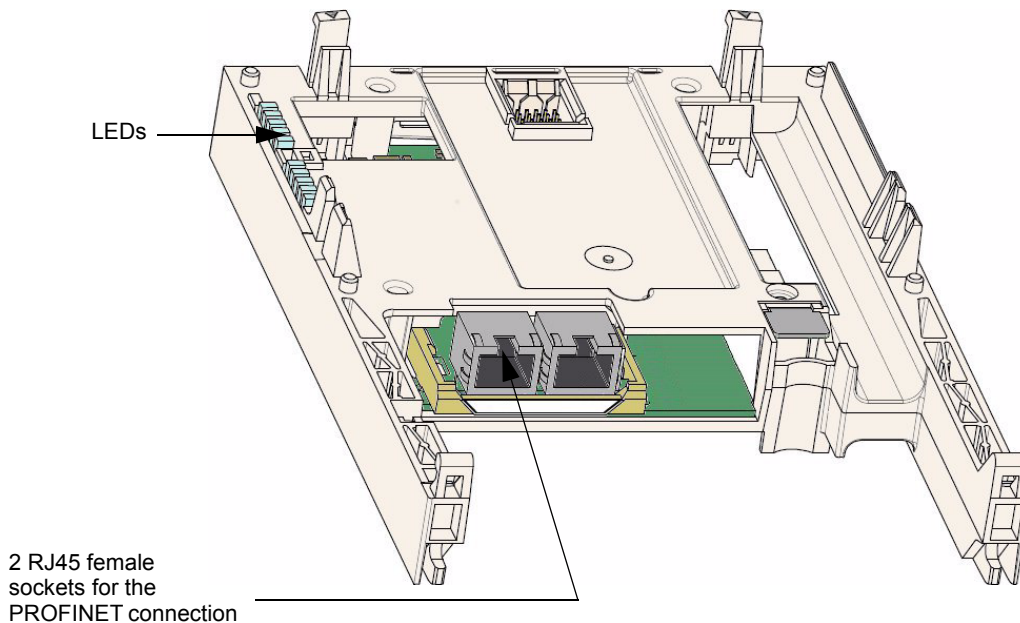

Firmware and GSDML Version Compatibility

VW3A3327 option card is compliant with Altivar61 V5.8 IE36 and Altivar71 V5.7 IE70 minimum versions.

Check the firmware version, on the packaging label (on the right part of the label).

The associated GSDML are named as the following example:

- GSDML-V2.5-Schneider-ATV71-20121001.xml
- GSDML-V2.5-Schneider-ATV61-20121001.xml

The files are available on www.schneider-electric.com.

Installation

Check that the card catalog number marked on the label is the same as that on the delivery note corresponding to the purchase order.

Remove the communication module from its packaging and check that it has not been damaged in transit.

NOTICE

RISK OF DAMAGE TO THE DRIVE

Install only communication modules designed for ATV61/71. See part numbers in the catalog.

Failure to follow these instructions can result in equipment damage.

Install the PROFINET module in ATV61/71

Refer to the installation manual (1755849 or 1755843, 1760655 or 1760643)

First remove the control front panel.

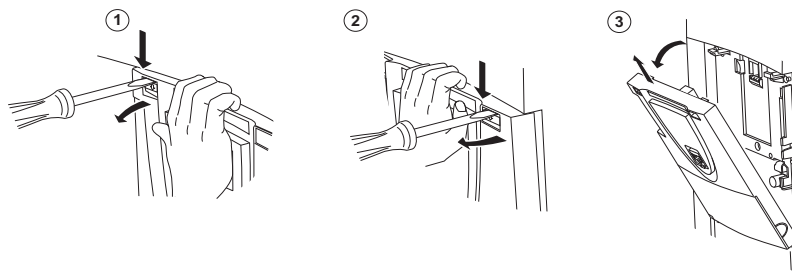

NOTICE

RISK OF DAMAGE TO THE CONNECTOR

Ensure good positioning of the option card on the clasps to avoid damage to the connector.

Failure to follow these instructions can result in equipment damage.

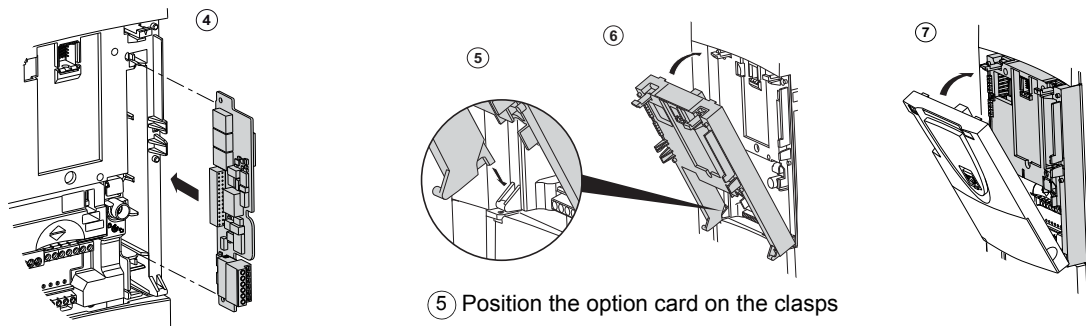

④ Install encoder interface card (if used)

⑤ Position the option card on the clasps

⑥ Then pivot it until it clicks into place

⑦ Replace the control front panel over the option card (same procedure as for installing the option card, see ⑤ and ⑥)

Wiring

The VW3A3327 option card is equipped with 2 RJ45 female sockets for the PROFINET connection.

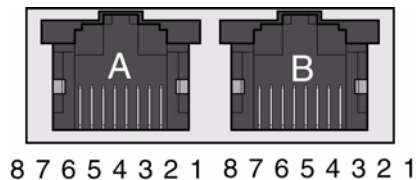

Cable specifications

- Minimum Cat 5e,
- Use equipotential bonding conductors, (100 BASE-TX, Category 5e or Industrial Ethernet fast connect)
- Connector RJ45, no crossover cable
- Shield: both ends grounded
- Twisted pair cable
- Verify that wiring, cables, and connected interfaces meet the PELV requirements.
- Maximum cable length per segment = 100 m (328 ft) / 6 plugs

The following table describes the pin out of each RJ45:

Pin	Signal	Meaning
1	Tx+	Ethernet transmit line +
2	Tx-	Ethernet transmit line -
3	Rx+	Ethernet receive line +
4	-	-
5	-	-
6	Rx-	Ethernet receive line -
7	-	-
8	-	-

Installation Topology

The VW3A3327 option card, with its 2 RJ45 connector, enables several wiring solutions:
Daisy Chain and/or Star topology



Ring topology



The ring topology can only be used with a Media Redundancy Protocol (MRP) capable managed device. The bus watchdog shall be increased when using MRP function in order to avoid untimely **[Com. network] (C n F)** trip.

Configuration and Parameters

3

Overview

This chapter describes the parameters of the VW3A3327 module. These parameters are described here according to the local HMI or the Graphic keypad. These settings are also possible from SoMove or from the embedded web server.

What Is in this Chapter?

This chapter contains the following topics:

Topic	Page
Network Settings	20
iPar Settings	22
Modbus TCP Settings	23

Network Settings

These parameters are accessible via the [1.9 - COMMUNICATION] (COM-) menu.

Parameter Description (HMI mnemonic)	Range or Listed Values	Default	Long Name	Short Name	Access	Parameter Number
[DEVICE NAME] (PAn)	16 characters max.	–	[–]	-	R/W	3340 to 3347
[IP mode] (IpM) Use this parameter to select the IP address assignment method.	0: Man 2: DHCP 3: DCP	Man	[fixed] [DHCP] [DCP]	MANU dHCP dCP	R/W	64250
[IP card] (IPC-) (IPC1) (IPC2) (IPC3) (IPC4) These fields are editable when IP mode is set to Fixed address	0 to 255 for each 4 fields	0.0.0.0	[0.0.0.0]	0 0 0 0	R/W	64212 64213 64214 64215
[IP Mask] (IPM-) (IPM1) (IPM2) (IPM3) (IPM4) These fields are editable when IP mode is set to Fixed address	0 to 255 for each 4 fields	0.0.0.0	[255.255.254.0]	255 255 254 0	R/W	64216 64217 64218 64219
[IP Gate] (IPG-) (IPG1) (IPG2) (IPG3) (IPG4) These fields are editable when IP mode is set to Fixed address	0 to 255 for each 4 fields	0.0.0.0	[0.0.0.0]	0 0 0 0	R/W	64220 64221 64222 64223
[Network error] (Err) Ethernet Error Code	0: No error 1: PROFINET I/O timeout 2: Network overload 3: Loss of Ethernet Carrier 9: Duplicated IP address. 10: No valid IP. 12: IPAR unconfigured state 13: IPAR unrecoverable error 17: Application I/O configuration error	0	–	–	R	64270
[SERVICES] (EWE-) Enable web services	0: No web services 1: Web server enabled	1	–	–	R/W	–
[PPO profile used] (PrFL) Actual profile	0: UNCFG 1: Profdrive 100: Device specif	0	[0]	0	R/W	6665
[MAC @] (MAC) MAC address display Displays MAC addresses of the device. Left port MAC address is +1. Right port MAC address is + 2.	[xx-xx-xx-XX-XX-XX]	–	[xx-xx-xx-XX-XX-XX]	–	–	–

If the IP address is not set to a valid value at first power-on, the drive will trip in EPF2.

Assigning IP parameters

The drive needs 3 IP parameters:

- The drive IP address.
- The subnet mask.
- The gateway IP address.

These IP addresses can be entered directly:

If [IP mode] (IpM) is set to [fixed] (MAnU). Using the integrated display terminal, using the graphic display terminal, or using the SoMove software.

They can be provided by either:

- A DHCP server (correspondence between the Device name and the IP addresses).
- A DCP (Discovery Control Protocol) protocol to discover PROFINET devices.

Entering IP parameters in the Terminal

In the [1.9 - COMMUNICATION] (COM-) menu, [PROFINET] (PNT-) submenu, enter the following IP parameters:

- [IP card] (IPC1) (IPC2) (IPC3) (IPC4),
- [IP Mask] (IPM1) (IPM2) (IPM3) (IPM4),
- [IP Gate] (IPG1) (IPG2) (IPG3) (IPG4).

Turn off the drive and then back on again (control voltage if a separate power supply is being used), otherwise the IP parameters are not taken into account.

If this address is modified, the new IP address entered is displayed. This IP address will be effective the next time the drive is turned on.

Case of manual switching of [IP mode] (IPMode)

1. When switching [IP mode] (IPMode) to [DCP] (dCP)

- IP Settings are no longer editable
- Turn off the drive supply and then back on again, including control voltage if a separate power supply is being used
- The new configuration is applied, the device is waiting for IP settings from PROFINET controller

2. When switching [IP mode] (IPMode) to [Manual] (Manu)

- IP Settings becomes editable
- Set IP settings with valid values
- Turn off the drive and then back on again, including control voltage if a separate power supply is being used
- The new configuration is applied

Note: If IP settings are not valid, the drive will trip in EPF2 after next power-on.

3. When switching [IP mode] (IPMode) to [DHCP] (dHCP)

- IP Settings are no longer editable.
- Set the Device Name with a valid value.
- Turn off the drive and then back on again, including control voltage if a separate power supply is being used.
- The new configuration is applied, the device is waiting for IP settings from DHCP Server.

Note: If the Device Name is not valid, the drive will trip in EPF2 after next power-on.

Case of automatic switching of [IP mode] (IPMode) to [DCP] (dCP)

Needed conditions:

- The device has a Station Name configured and validated
- The device is connected to a PROFINET controller
- The PROFINET controller has the Station Name in its own configuration
- The settings are in local configuration of the PROFINET controller

If all of these conditions are fulfilled:

- [IP mode] (IPMode) is automatically set to [DCP] (dCP)
- IP settings are replaced by the one set in local PROFINET controller
- The new configuration is applied immediately

iPar Settings

These parameters are accessible via the [1.9 - COMMUNICATION] (COM-) menu and [PROFINET] (PNT-) submenu.

The following table describes the parameters related to the iPar settings server function

Parameter Description (HMI mnemonic)	Range or Listed Values	Default	Long Name	Short Name	Access	Parameter Number
[iPar Validation] (IPAU) Enable iPar service	0: no 1: yes	0	[No] [Yes]	(n0) (YES)	R/W	64274
[iPar Autosave] (IPAS) Enable iPar autosave service	0: no 1: yes	0	[No] [Yes]	(n0) (YES)	R/W	64275
[iPar timer] (IPAT) Interval for periodic saving of the iPar service	0: no autosave 1 to 9999 (minutes)	10	–	–	R/W	64278
[iPar Error Mgt] (IPAF) Enable iPar detected error management	0: no 1: yes	1	[No] [Yes]	(n0) (YES)	R/W	64277
[iPar Local Conf] (ICFG) Selection of local or server configuration	0: The drive configuration is downloaded from the iPar server at Power ON of the drive. 1: The drive configuration is local.	0	[No] [Yes]	(n0) (YES)	R/W	64276
[iPar Status] (IPAE) iPar service status	0: idle state 1: initialization 2: configuration 3: ready 4: operational 5: not configured 6: Unrecoverable fault state		[IDLE] [INIT] [CONF] [RDY] [OPE] [UCFG] [UNREC]	(IDLE) (INIT) (CONF) (RDY) (OPE) (UCFG) (UNREC)	R	64279
[iPar Error Cod] (IPAD) Detected error code	0: No detected error 1: Stored configuration is not ok 2: No configuration file on the IPAR server or configuration is not compatible. (Served configuration is not ok) 3: Detected error connection to the IPAR configuration file on the server. 4: Detected error writing the configuration file to the server.	0	[0] [1] [2] [3] [4]	(0) (1) (2) (3) (4)	R	64280

Modbus TCP Settings

The Modbus channel is only used for commissioning tools and for embedded webserver (UnitID 251: Communication card, Unit ID 248: Variable Speed Drive).

Function Name	Code	Description	Remarks
Read Multiple Register	03 16#03	Read Multiple Register	Max PDU length: 63 words
Write Single Register	06 16#06	Write Single Register	–
Diagnostic	08 16#08	Diagnostic	–
Write multiple register	16 16#10	Write Multiple Register	Max PDU length: 63 words
Read device Identification	43 16#2B	Schneider Identification	(subfunction 14/16#0E) See the table below

Identification

Byte(s)	Meaning	With the VW3 A3327 PROFINET card	
0	Function code = 16#2B	16#2B	
1	Type of MEI	16#0E	
2	ReadDeviceId code	16#01	
3	Degree of conformity	16#02	
4	Number of additional frames	16#00 (a single frame)	
5	Next object ID	16#00	
6	Number of objects	3 for Basic 4 for Regular or Extended	
7	Object 1 ID	16#00 = Vendor Name	
8	Length of object 1 (A)	13	
9...21	Value of object 1 (A ASCII characters)	"SchneiderElectric"	
22	Object 2 ID	16#01 = Product Code	
23	Length of object 2 (B)	11 (for the following example only)	
24...23+B	Value of object 2 (B ASCII characters) (1)	Example: "ATV71HU15M3"	
24+B	Object 3 ID	16#02 = Major.Minor Revision	
25+B	Length of object 3 (C)	4	
26+B...29+B	Value of object 3 (C ASCII characters)	Example: "0201" for version 2.1	
30+B	Object 4 ID	16#06 = Application Name (2)	for Regular and Extended
31+B	Length of object 4 (D)	8 (for the following example only)	
32+B...31+B+D	Value of object 4 (D ASCII characters) (1)	Example: "MACHINE 4"	

(1) The length of this field is variable. Use the "Length of object X" field associated with it to determine the length.

(2) In the case of the drive, this data item corresponds to [\[DEVICE NAME\]](#).

The response to a "drive identification" request does not cause an exception response.

Configuration



4

What Is in this Chapter?

This chapter contains the following topics:

Topic	Page
Configuring the Control Channel	26
Configuring Monitor Parameters	29
Configuring Communication Interruption Management	30

Configuring the Control Channel

This chapter explains through 3 examples how to configure the drive for operation from communication network. Several other combinations are possible. The whole coverage of these possibilities is not in the scope of this document. For more information, refer to the programming manual.

- I/O Mode - a simple command Word (based on forward, reverse, and reset binary commands).
- Combined Mode (with native profile CiA402) - Both reference and command word come from the communication network.
- Separate (with native profile CiA402) - reference and command come from separate sources: for example, the command (in CiA402) comes from the communication network and the reference from the HMI.

Configuration of the Drive for Operation in I/O Profile

To illustrate the I/O Profile, we will describe a simple example, which can be extended with additional features. The Command word is made of Run forward (bit 0 of $C \Pi d$), run reverse (bit 1 of $C \Pi d$), and a detected fault reset (bit 7 of $C \Pi d$).

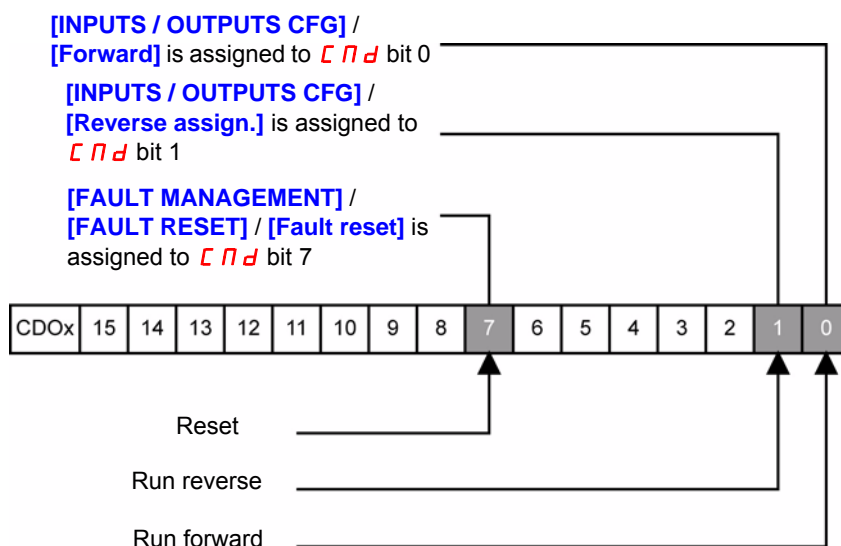

NOTE: This operating mode is not applicable when the drive is configured from the controller to operate with the telegram 1 (PROFIdrive).

The settings will be the following:

[Ref.1 channel] ($F r 1$)	[Com. card] ($n E k$)
[Profile] ($C H C F$)	[I/O profile] ($I D$)
[Cmd switching] ($C C 5$)	Default value
[Cmd channel 1] ($C d 1$)	[Com. card] ($n E k$)

The bits of the command word can now be configured.

In the [INPUTS / OUTPUTS CFG] menu, configure:

[Forward] ($F r d$)	[Cd00] ($C d 0 0$)
[Reverse assign.] ($r r 5$)	[Cd01] ($C d 0 1$)

In the [FAULT MANAGEMENT] menu, [FAULT RESET] submenu, configure:

[Fault reset] ($r 5 F$)	[Cd07] ($C d 0 7$)
---------------------------	----------------------

Configuration of the Drive for Operation With CiA402 Profile in Combined Mode

This chapter describes how to configure the settings of the drive if it is controlled in CiA402 Mode. The example focuses on the Not separate mode. Additional modes combined mode are detailed in the Altivar 61 and Altivar 71 Programming manual.

In the Command Menu [1.6 COMMAND] (C E L -):

- **[Ref.1 Channel] (F r I)**: is set on according to the communication source you can choose in the following table:

Origin of the control	Ref1 Channel setting
PROFINET	[Com. card] (n E k)

- **[Ref. 2 switching] (r F C)** is set to default value (**[Ref.1 Channel] (F r I)**).
- **[Profile] (C H C F)**: defines if the drive operates in combined mode (reference and command from the same channel).

For the current example, **[Profile] (C H C F)** will be adjusted to **[Not separ.] (S I n)** as reference and control are originated from the communication network:

Profile	Ref1 Channel setting
CiA402 combined mode	[Not separ.] (S I n)
CiA402 separate mode	[Separate] (S E P)
I/O Profile	[I/O profile] (I D)

Configuration of the Drive for Operation with CiA402 Profile in Separate Mode

Alternate combinations are possible, see the ATV61/71 programming manual for the list of possible settings.
 Example:



The drive is controlled from the communication (PROFINET) but the reference is adjusted on controller terminal. The control word comes from the controller and is written according to CiA402 profile.

The settings will be the following:

[Ref.1 channel] (<i>Fr1</i>)	[AI1] (<i>RII</i>)
[Profile] (<i>CHCF</i>)	[Separate] (<i>SEP</i>)
[Cmd channel 1] (<i>CDI</i>)	[Com. card] (<i>NEK</i>)
[Ref. 2 switching] (<i>rFL</i>)	Factory setting

Configuring Monitor Parameters

It is possible to select up to 4 parameters to display their values in the [\[1.2 MONITORING\]](#) menu on the graphic display terminal (to be ordered separately - part number VW3 A1 101).

The selection is made via the [\[6 MONITORING CONFIG.\]](#) menu ([\[6.3 COM. MAP CONFIG.\]](#) submenu).

Each parameter in the range [\[Word 1 add. select.\] ... \[Word 4 add. select.\]](#) can be used to select the parameter logic address. An address at zero is used to disable the function.

Example

In the example given here, the monitored words are:

- Parameter 1 = Motor current (**L C r**): logic address 3204, signed decimal format.
- Parameter 2 = Motor torque (**D t r**): logic address 3205, signed decimal format.
- Parameter 3 = Last detected fault occurred (**L F t**): logic address 7121, hexadecimal format.
- Disabled parameter: 0; default format: Hexadecimal format

RDY	NET	+0.00Hz	0A
6.3 COM. MAP CONFIG.			
Word 1 add. select.	:		3204
Format word 1	:		Signed
Word 2 add. select.	:		3205
Format word 2	:		Signed
Word 3 add. select.	:		7121
<input type="checkbox"/> Code		Quick	<input checked="" type="checkbox"/>
Format word 33	:		Hex
Word 4 add. select.	:		0
Format word 4	:		Hex

One of the three display formats below can be assigned to each monitored word:

Format	Range	Terminal display
Hexadecimal	0000 ... FFFF	[Hex]
Signed decimal	-32 767 ... 32 767	[Signed]
Unsigned decimal	0 ... 65 535	[Unsigned]

NOTE: If a monitored parameter:

- has been assigned to an unknown address,
- has not been assigned,

the value displayed in the [\[6.3 COMMUNICATION MAP\]](#) screen is: "••••" (see "Diagnostics and monitoring" on page 31).

Configuring Communication Interruption Management

The response of the drive in the event of a PROFINET communication interruption can be configured. Configuration can be performed using the graphic display terminal or the integrated display terminal via the **[Network fault mgt] (C L L)** in the **[1.8 FAULT MANAGEMENT] (F L E-)** menu, (**[COM. FAULT MANAGEMENT] (C L L-)** submenu).

RDY	NET	+0.00Hz	0A
COM. FAULT MANAGEMENT			<input type="checkbox"/>
Network fault mgt	:	Freewheel	
CANopen fault mgt	:	Freewheel	
Modbus fault mgt	:	Freewheel	
Code		Quick	<input type="checkbox"/>

The values of the **[Network fault mgt] (C L L)** parameter, which trigger a drive detected fault **[Com. network] (C n F)**, are:

Value	Meaning
[Freewheel] (Y E S)	Freewheel stop (factory setting)
[Ramp stop] (r P P)	Stop on ramp
[Fast stop] (F S E)	Fast stop
[DC injection] (d C I)	DC injection stop

The values of the **[Network fault mgt] (C L L)** parameter, which do not trigger a drive detected fault, are:

Value	Meaning
[Ignore] (n D)	Detected fault ignored
[Per STT] (S E E)	Stop according to configuration of [Type of stop] (S E E)
[fallback spd] (L F F)	Change to fallback speed, maintained as long as the detected fault persists and the run command has not been removed
[Spd maint.] (r L S)	The drive maintains the speed at the time the detected fault occurred, as long as the detected fault persists, and the run command has not been removed

The fallback speed can be configured in the **[FAULT MANAGEMENT] (F L E-)** / **[FALLBACK SPEED] (L F F -)** menu using the **[Fallback speed] (L F F)** parameter.

▲ WARNING

LOSS OF CONTROL

If PROFINET fault management **[Network fault mgt] (C L L)** is set to **[Ignore] (n D)**, communication control will be inhibited.

For safety reasons, inhibiting the communication interruption detection must be restricted to the debug phase or to special applications.

Failure to follow these instructions can result in death, serious injury, or equipment damage.

Diagnostics and monitoring



5

What Is in this Chapter?

This chapter contains the following topics:

Topic	Page
LED Indicators	32
Communication Diagnostics	34
Monitoring of communication Channels	36
Control-Signal Diagnostics	38

LED Indicators

The following figure describes the LEDs status module:

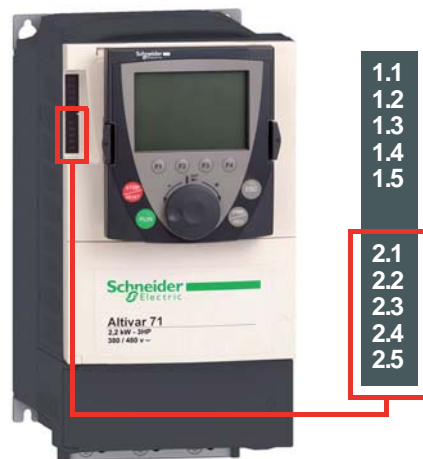

LED Description

LED	Description
2.1: LNK	Port 1 activity
2.2: LNK	Port 2 activity
2.3: RUN/BF	Module status
2.4: STS/SF	Network status

LEDs 2.1 and 2.2: Link Activity

These LEDs indicate the status of the Ethernet port A (1) and Ethernet port B (2):

Color & Status	Description
OFF	No link
Green ON	Link established at 100 Mbps
Green Blinking	Network Activity at 100 Mbps
Yellow ON	Link established at 10 Mbps
Yellow Blinking	Network Activity at 10 Mbps

LED 2.3: Module Status

This LED indicates the module status:

Color & Status	Description
OFF	The device is powered off
Red ON	The device has detected an ILF detected fault state
Green ON	The device is ready and operational
Red flickering	The device has detected a communication interruption / bad configuration or a PROFINET controller at Stop state.
Green flickering	In combination with other LEDs: DCP manual identification phase / DCP flash mode
Green/Red blinking	Power up testing
Red Single flash	No connection to the PROFINET controller

LED 2.4: Network ERRor Status

Color & Status	Description
OFF	The device does not have an IP address or powered off
RED ON	General error detected on the module
Green ON	At least a port is connected and has a valid IP address.
Green flickering	In combination with other LEDs: DCP manual identification phase / DCP flash mode or as long as the iPar-Client did not accomplish transfer (backup or restore) its Parameters
Green/Red blinking	Power-up testing
Green flashing 3 times	All ports are unplugged, but the card has an IP address
Green flashing 4 times	Error detected: duplicate IP address
Green flashing 5 times	The card is performing a DHCP sequence

Note: If the communication card operates as a Modbus TCP server only, LED 2.3 and LED 2.4 have another behavior. For more details, see Modbus TCP manual VW3A3320.

LED Behavior Detail

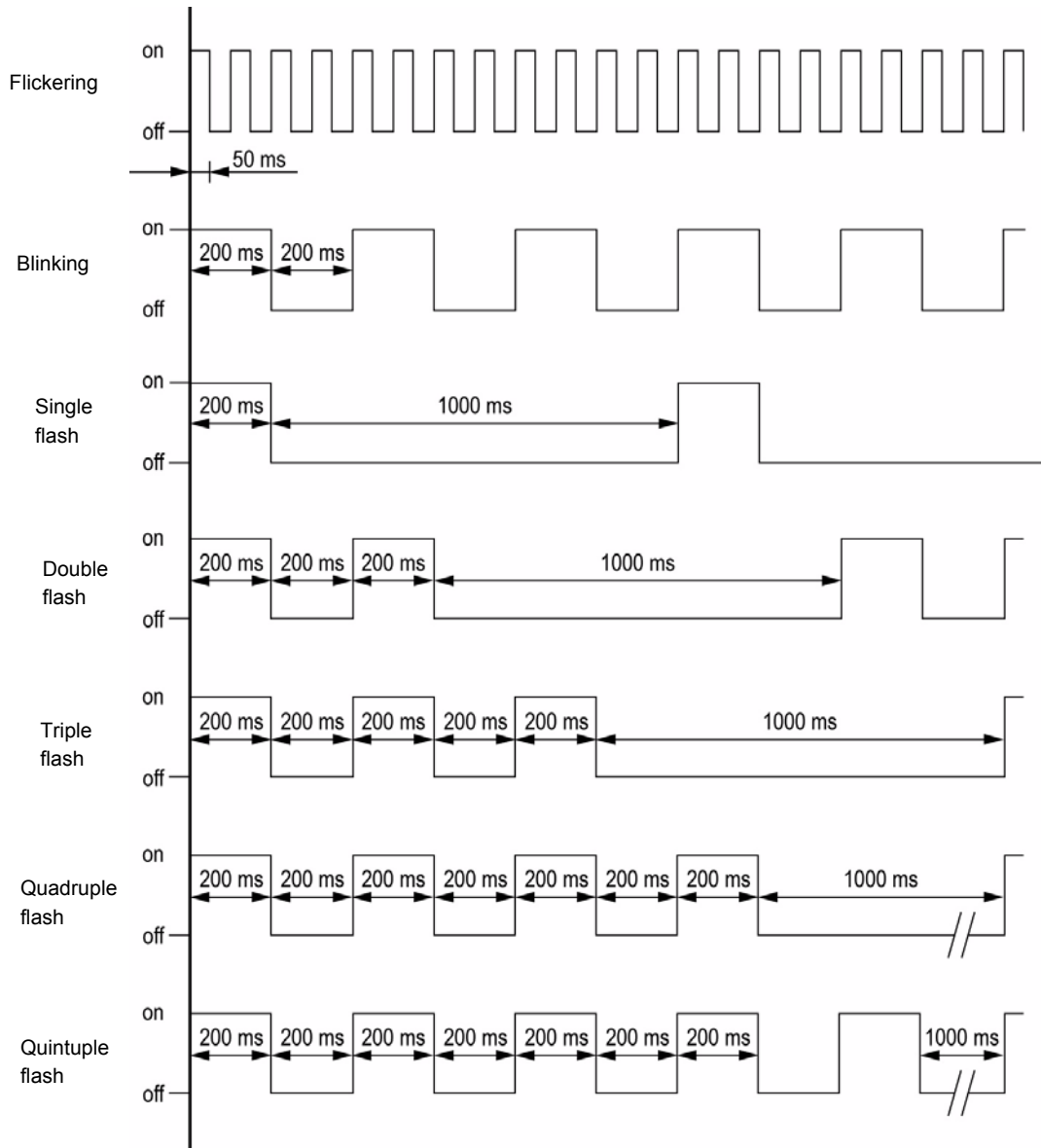

Communication Diagnostics

A properly operating fieldbus is required for evaluating operating and detected faults messages.

Connections for Fieldbus Mode

If the product cannot be addressed via the fieldbus, first check the connections. The product manual contains the technical data of the device and information on network and device installation. Check the following:

- Power connections to the device
- Fieldbus cable and fieldbus wiring
- Network connection to the device

Fieldbus Function Test

If the connections are correct, check the settings for the fieldbus addresses. After correct configuration of the transmission data, test the fieldbus mode.

In addition to the controller that knows the product via the data in the GSDML file and the address, a bus monitor should be installed. As a passive device, it can display messages.

- Switch off or on the supply voltage of the drive system.
- Observe the network messages shortly after switching on the drive system. A bus monitor can be used to record the elapsed time between telegrams and the relevant information in the telegram.

Possible Errors: Addressing, Parameterization, Configuration

If it is impossible to connect to a device, check the following:

- Addressing: The address of the network device must be a valid IP address. Each network device must have a unique address.
- Parameterization: The parameterized Ident number and the user parameters must match the values stored in the GSDML file.

Communication interruption

The drive trips in [\[internal com. link\] \(IL F \)](#) when the following events occur:

- Hardware detected fault on the PROFINET card
- Communication interruption between the PROFINET card and the drive

The response of the drive in the event of an [\[internal com. link\] \(IL F \)](#) detected fault cannot be configured, and the drive trips with a freewheel stop. This detected fault cannot be cleared except by switching off the drive.

2 diagnostic parameters can be used to obtain more detailed information about the origin of the [\[internal com. link\] \(IL F \)](#) detected fault:

- [\[Internal link fault 1\] \(IL F 1 \)](#) if the detected fault has occurred on option card 1 (installed directly on the drive)
- [\[Internal link fault 2\] \(IL F 2 \)](#) if the detected fault has occurred on option card 2 (installed on option card 1)

The PROFINET card can be in position 1 or 2.

The [\[Internal link fault 1\] \(IL F 1 \)](#) and [\[Internal link fault 2\] \(IL F 2 \)](#) parameters can only be accessed on the graphic display terminal in the [\[1.10 DIAGNOSTICS\] \(D G E - \)](#) menu, [\[MORE FAULT INFO\] \(A F I - \)](#) submenu.

Value	Description of the values of the [Internal link fault 1] (IL F 1) and [Internal link fault 2] (IL F 2) parameters
0	No detected fault
1	Internal communication interruption with the drive
2	Hardware fault detected
3	Error found in the EEPROM checksum
4	EEPROM
5	Flash memory
6	RAM memory
7	NVRAM memory
8	Analog input
9	Analog output
10	Logic input
11	Logic output
101	Unknown card
102	Exchange fault detected on the drive internal bus
103	Time out on the drive internal bus (500 ms)

Diagnostic (PROFINET Service)

PROFINET diagnostic are associated with specific data which can be helpful during maintenance:

- The detected fault code, if a detected fault is present,
- The value of ETA,
- The value of the speed.

This data report and gives an indication on the drive status when the diagnostic event was triggered

Diagnostic information Read:

byte	Description	
1...28	Reserved	
29	Ext_Diag_Data	External diagnostic data length = 6
30		IF ETA.bit 3 = 1: ADL LFT LSB Otherwise: 0
31		ADL ETA LSB
32		ADL ETA MSB
33		LSB of the last value of the output speed
34		MSB of the last value of the output speed

Enabling Diagnostics

By default, Alarm Diagnostics are enabled. It can be activated/deactivated during the configuration phase as shown below:

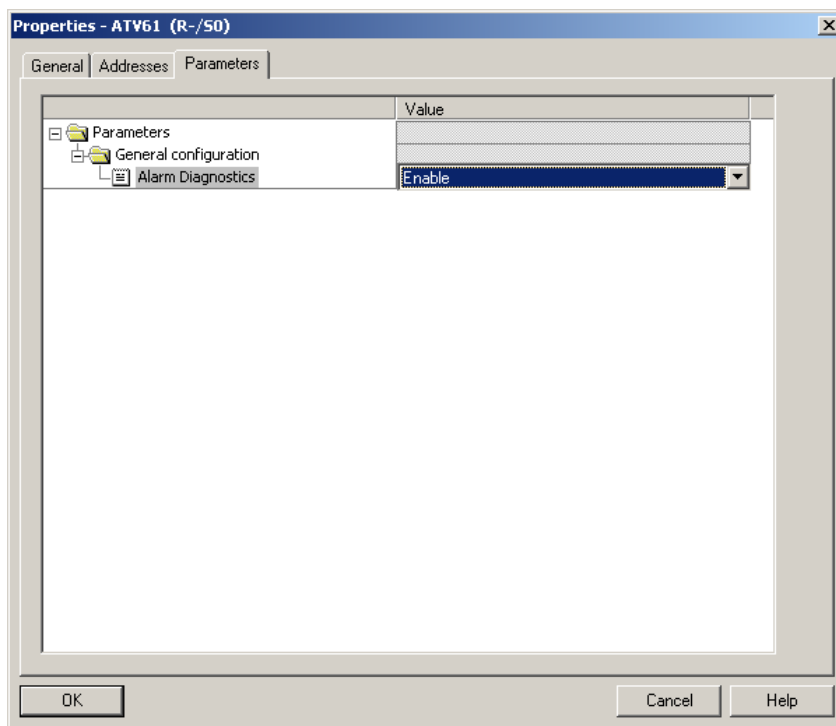

Monitoring of communication Channels

Command and Reference Channels

All the drive's command and reference parameters are managed on a channel-by-channel basis.

It is possible to identify the last value written for each channel and each command or reference parameter:

Parameter name	Parameter code				
	Taken into account by the drive	Modbus	CANopen	Communication card	PLC card
Control word	(C Nd)	(C Nd 1)	(C Nd 2)	(C Nd 3)	(C Nd 4)
Extended control word	(C N 1)	(C N 1 1)	(C N 1 2)	(C N 1 3)	(C N 1 4)
Speed reference (rpm)	(L F r d)	(L F r d 1)	(L F r d 2)	(L F r d 3)	(L F r d 4)
Frequency reference (0.1 Hz)	(L F r)	(L F r 1)	(L F r 2)	(L F r 3)	(L F r 4)
PI regulator reference	(P 1 S P)	(P 1 r 1)	(P 1 r 2)	(P 1 r 3)	(P 1 r 4)
Analog multiplier reference	(N F r)	(N F r 1)	(N F r 2)	(N F r 3)	(N F r 4)

Network Monitoring Criteria

The network is monitored according to the protocol-specific criteria.

Protocol	Criteria	Related detected fault
PROFINET card	10: No valid IP	[EXTERNAL FAULT COM.] (E P F 2)
	9: Duplicated IP address	
	12: iPar unconfigured	
	13: iPar unrecoverable error detected	
	0: No detected fault	[Com. network] (C n F)
	1: Network timeout (configurable timeout) for received requests destined for the drive	
	2: Network overload	
	3: Loss of Ethernet Carrier	
	17: Application I/O configuration error detected	
	EEPROM detected error	[internal com. link] (I L F)

Monitoring of Communication Channels

Communication channels are monitored if they are involved in one of the following parameters:

- The control word **[Cmd value] (C P d)** from the active command channel
- The control word containing the command switch (bit configured on **[Cmd switching] (C C 5)**)
- The control word containing the switch for reference 1'1B (bit configured on **[Ref 1B switching] (r C b)**)
- The control word containing the switch for reference 1'2 (bit configured on **[Ref. 2 switching] (r F C)**)
- The frequency or speed reference (**[HMI Frequency ref.] (L F r)** or LFRD: Nominal speed value) from the active reference channel
- Summing frequency or speed reference (**[HMI Frequency ref.] (L F r)** or LFRD: Nominal speed value) 2 (assigned to **[Summing ref. 2] (S R 2)**)
- Summing frequency or speed reference (**[HMI Frequency ref.] (L F r)** or LFRD: Nominal speed value) 3 (assigned to **[Summing ref. 3] (S R 3)**)
- Subtracting frequency or speed reference (**[HMI Frequency ref.] (L F r)** or LFRD: Nominal speed value) 2 (assigned to **[Subtract ref. 2] (d R 2)**)
- Subtracting frequency or speed reference (**[HMI Frequency ref.] (L F r)** or LFRD: Nominal speed value) 3 (assigned to **[Subtract ref. 3] (d R 3)**)
- The PID regulator reference (PISP)
- The PID regulator feedback (**[AI Virtual 2] (A I U 2)**)
- The reference multiplication coefficient (**[Multiplying coeff.] (P F r)**) 2 (assigned to **[Multiplier ref. 2] (P R 2)**)
- The reference multiplication coefficient (**[Multiplying coeff.] (P F r)**) 3 (assigned to **[Multiplier ref. 3] (P R 3)**)

As soon as one of these parameters has been written once to a communication channel, it activates monitoring for that channel.

If a communication alarm signal is sent (in accordance with the protocol criteria) by a monitored port or network card, the drive will trigger a communication interruption.

The drive reacts according to the communication interruption configuration (detected fault, maintenance, fallback, and so on.)

If a communication alarm signal occurs on a channel that is not being monitored, the drive will not trigger a communication interruption.

Enabling of Communication Channels

A communication channel is enabled once all the parameters involved have been written at least one time.

The drive is only able to start if all channels involved in command and reference are enabled.

Example:

A drive in DSP402 profile is connected to an active communication channel.

It is mandatory to write at least one time the reference and the command in order to switch from "4-Switched on" to "5-Operation enabled" state.

A communication channel is disabled:

- In the event of a communication alarm signal
- In "forced local" mode.

Note: On exiting "forced local" mode:

- The drive copies the run commands, the direction and the forced local reference to the active channel (maintained).
- Monitoring of the active command and reference channels resumes following a time delay **[Time-out forc. local] (F L D t)**.
- Drive control only takes effect once the drive has received the reference and the command from the active channel.

Control-Signal Diagnostics

On the terminal, the **[1.2 - MONITORING]** (*S U P -*) menu (**[COMMUNICATION MAP]** (*C P P -*) submenu) can be used to display control-signal diagnostic information between the Altivar drive and the controller:

- Active command channel **[Command channel]** (*C P d C*)
- Value of the control word (CMD) from the active command channel **[Cmd value]** (*C P d*)
- Active target channel **[Active ref. channel]** (*r F C C*)
- Value of the target from the active target channel **[Frequency ref.]** (*F r H*)
- Value of the status word **[ETA state word]** (*E t A*)
- Values of the 4 parameters selected by you (W---)
- In the **[CMD. WORD IMAGE]** submenu: control words from all channels
- In the **[FREQ. REF. WORD MAP]** submenu: frequency targets produced by all channels

Example

Example of the display of communication diagnostic information:

RUN	nEt	+50.00Hz	80A
COMMUNICATION MAP			
Command Channel	:		Com.Card
Cmd value	:		000FHex
Active ref. channel	:		Com.Card
Frequency ref.	:		500.0Hz
ETA state word	:		8627Hex
Code		Quick	▼
W3204	:		73
W3205	:		725
W7132	:		0000Hex
W0	:		----
CMD. WORD IMAGE			
FREQ. REF. WORD MAP			
MODBUS NETWORK DIAG			
MODBUS HMI DIAG			

Control Word Display

The **[Command Channel]** (*C P d C*) parameter indicates the active command channel.

The **[Cmd value]** (*C P d*) parameter indicates the hexadecimal value of the control word (CMD) used to control the drive.

The **[CMD. WORD IMAGE]** (*C I -*) submenu (**[CANopen cmd.]** (*C P d E*) parameter) is used to display the hexadecimal value of the control word sent by CANopen.

Frequency Target Display

The **[Active ref. channel]** (*r F C C*) parameter indicates the active target channel.

The **[Frequency ref]** parameter indicates the value (in 0.1 Hz units) of the frequency target (LFR) used to control the drive.

The **[FREQ. REF. WORD MAP]** submenu (**[COM. card cmd]** parameter) is used to display the value (in 0.1 Hz units) of the speed target sent by the network.

Status Word Display

The **[ETA state word]** (*E t A*) parameter gives the value of the status word (ETA).

Display of the Parameters Selected by the User

The 4 [W••] parameters give the value of the 4 monitored words you selected.

The address and display format of these parameters can be configured in the [3.3 MONITORING CONFIG.] (PLF -) menu ([COM. MAP CONFIG.] (ADL -) submenu).

The value of a monitored word equals "••••" if:

- Monitoring has not been activated (address equals W0),
- The parameter is not known (example: W3200).

Telegram 100



6

What Is in this Chapter?

This chapter contains the following topics:

Topic	Page
Overview	42
Configuring an ATV61/71 With a Siemens© S7-300	44
Configuration of the Altivar 61/71 With the Telegram 100	45
Parameters Management With the telegram 100	47

Overview

The following diagram shows the natives modes for telegram 100:

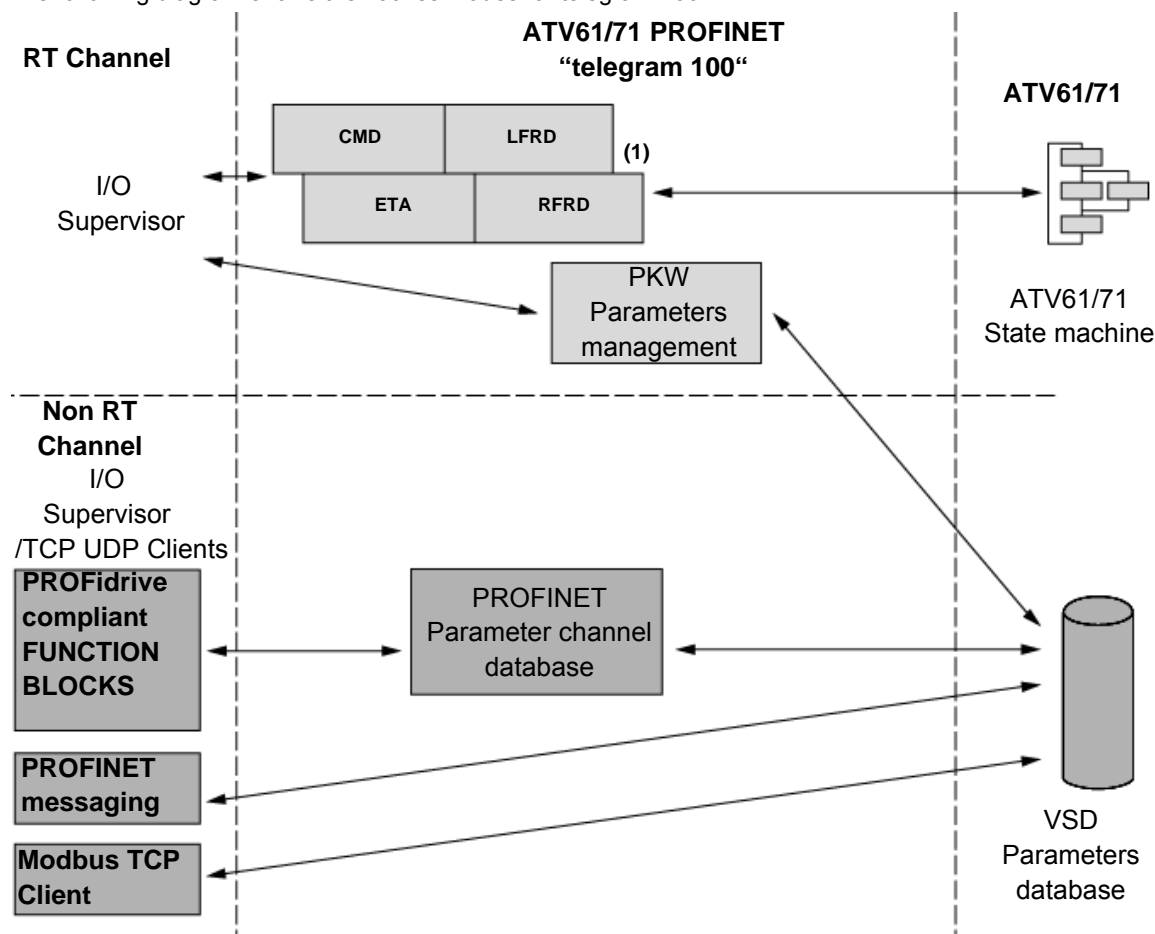

(1) 6 additional parameters can be configured in the communication scanner.

The native mode of the PROFINET VW3A3327 is used when telegram 100 is used.

Native mode of the ATV61/71 is compliant with IEC 61800-7 (CiA402).

The PKW area of telegram 100, which is used for a simple parameter management, is compliant with the PKW mechanism used with the PROFINET option cards of the ATV61/71.

Note: After switching from one telegram to another, the drive shall be restarted to validate the new configuration.

Periodic Exchanges

The following table lists the mapping process of the periodic data according to the chosen telegram:

	PLC → VSD	VSD → PLC	PP0
PKW1	PKE	PKE	PKW1
PKW2	R/W	R/W	PKW2
PKW3	PWE	PWE	PKW3
PKW4	PWE	PWE	PKW4
Cyclic data 1	OCA1 (def = CMD*)	OMA1 (def = ETA*)	PZD1
Cyclic data 2	OCA2 (def = LFRD*)	OMA2 (def = RFRD*)	PZD2
Cyclic data 3	OCA3	OMA3	PZD3
Cyclic data 4	OCA4	OMA4	PZD4
Cyclic data 5	OCA5	OMA5	PZD5
Cyclic data 6	OCA6	OMA6	PZD6
Cyclic data 7	OCA7	OMA7	PZD7
Cyclic data 8	OCA8	OMA8	PZD8

*:default Modbus address.

The configuration of the cyclic data is made with the PROFINET IO-Controller configuration tool. The Modbus address of the parameter linked to each cyclic data must be defined as in the following example with the HW configuration software:

Input cyclic data 1/2 and output cyclic data 1/2 are already preconfigured to **(C N d)** (8501) and **(L F r d)** (8602); **(E t A)** (3201) and **(r F r d)** (8604).

If a null address Modbus is entered, no link between the related cyclic data and the drive will be established. In any case the 6 cyclic data are not disabled and the 6 cyclic data will take place in the I/O memory image of the controller.

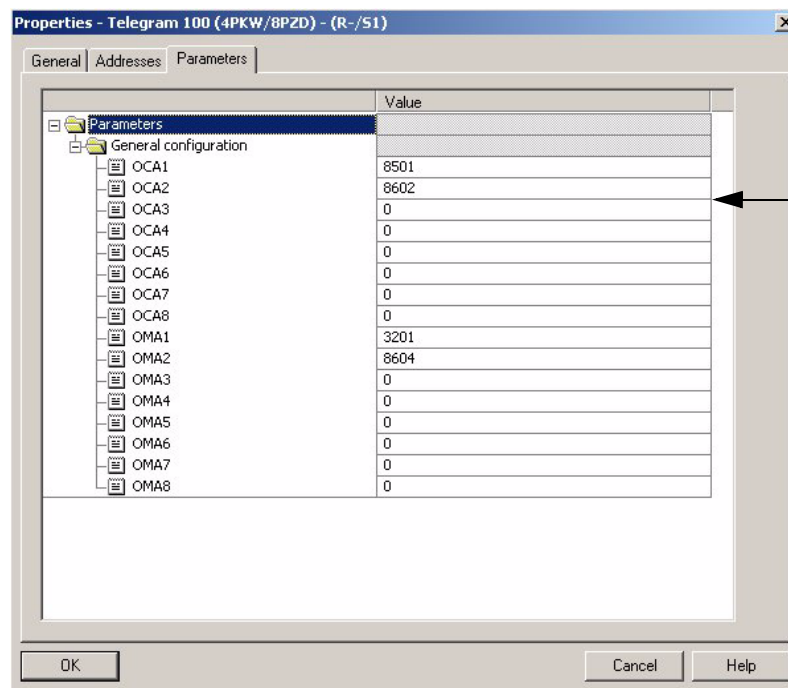

The Modbus address is entered in this field

Configuring an ATV61/71 With a Siemens® S7-300

GSDML Installation

First, download and install the GSDML file of the Altivar in the Hardware configuration tool of The SIMATIC STEP7® software.

You can find the GSDML file and its associated picture on www.schneider-electric.com

From the menu > Options > Install GSD File... as follows:

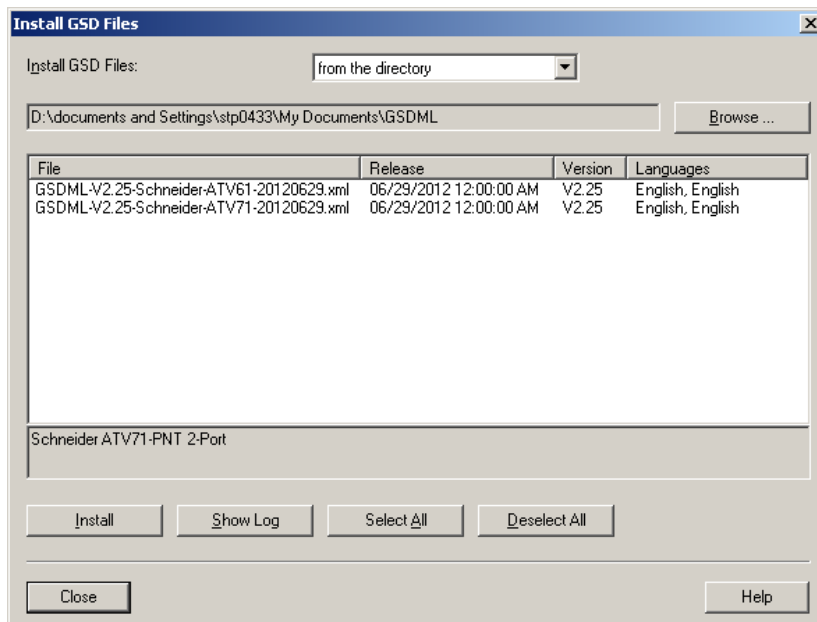

Once installed you will see the Altivar 61/71, in the library, as follow:

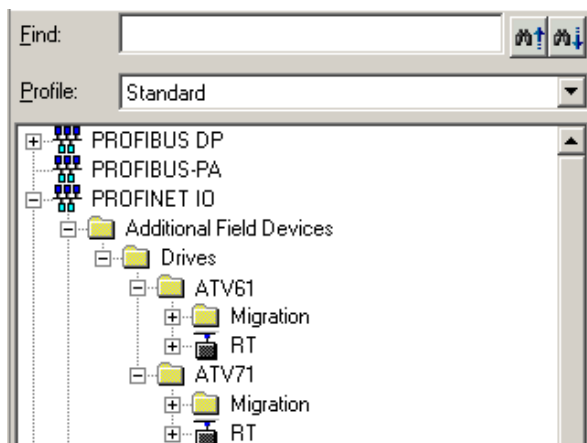

Configuration of the Altivar 61/71 With the Telegram 100

With this telegram, the Altivar 61/71 is controlled with 2 process data. In addition, 8 read and 8 write cyclic data can be used to read or write Altivar 61/71 parameters.

Configure the PLC and its PROFINET network. Then, drag and drop the Altivar 61/71 from the library to the Bus:

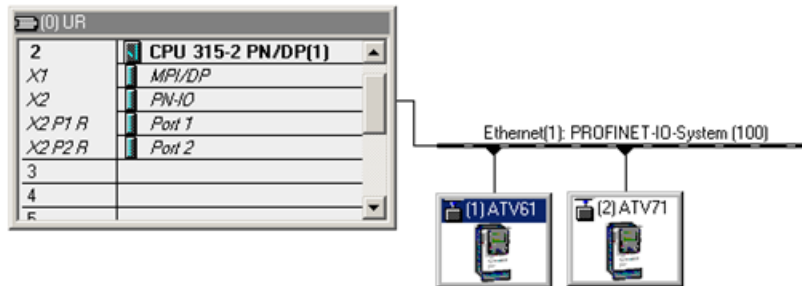

Define the addresses of the cyclic data and PKW data in the PLC periphery:

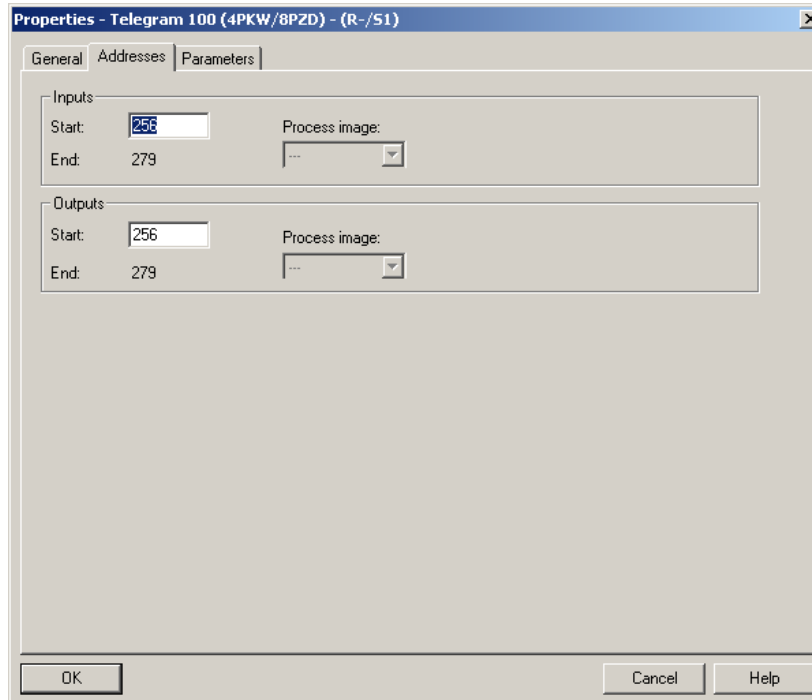

By default, the process data are linked to (*C P d*), (*L F r d*), (*E E R*) and (*r F r d*) (native CiA402 profile of the drive). You can check that the exchanges are working properly by the Monitor / Modify function of the configuration tool:

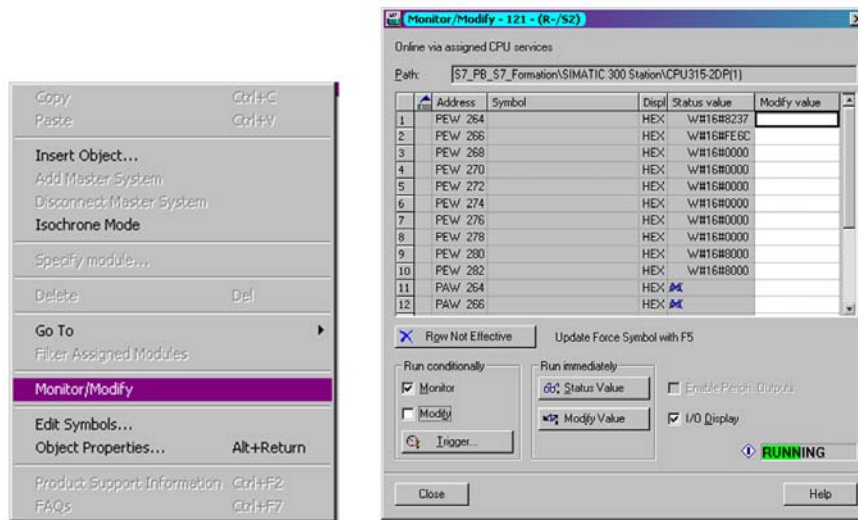

Parameters Management With the telegram 100

In native modes several accesses to the Drive parameters are possible:

- The standard acyclic requests from PROFIdrive (described in the “Annex B - The PROFIdrive Parameters Channel” on page 75)
- PKW mechanisms – consistent with Altivar 61/71.

Parameter Management Through the PKW Area

With telegram 100, you can read or write any drive parameter by using this PKW area. (This addressing scheme is identical to the PKW mechanism of the Altivar 32).

NOTE: The management of the parameters (compatibility with series 1 product) is Schneider Electric specific. Actually, previous versions of PROFIdrive also specified parameters management through PKW, are not compatible with Schneider Electric method. In recent versions, parameters are managed with acyclic messages, and the PNO PKW method is obsolete.

The PKW area is made of 4 input words and 4 output words.

The following table lists the controller-to-drive parameters in the input PKW area:

PKW nr	PKW1	PKW2	PKW3	PKW4
PKE Name	PKE	R/W	PWE	PWE
Description	The Modbus address of the parameter is detailed here.	Request code: 0: no request 1: read 2: write	Not used	Parameter value in case of write request.

The following table lists the drive-to-controller parameters in the output PKW area:

PKW nr	PKW1	PKW2	PKW3	PKW4
PKE Name	PKE	R/W	PWE	PWE
Description	Copy of the input PKE	Request code: 0: no request 1: read done 2: write done 3: request in progress 7: read or write detected error	Not used	If the request is successful, the parameter value is copied here.

Telegram 1

**7**

What Is in this Chapter?

This chapter contains the following topics:

Topic	Page
Overview	50
State Diagram	51
Command Word and Status Word	52
Speed Setpoint	55
PROFIdrive / Acyclic Messaging	55

Overview

The following diagram shows the operating modes:

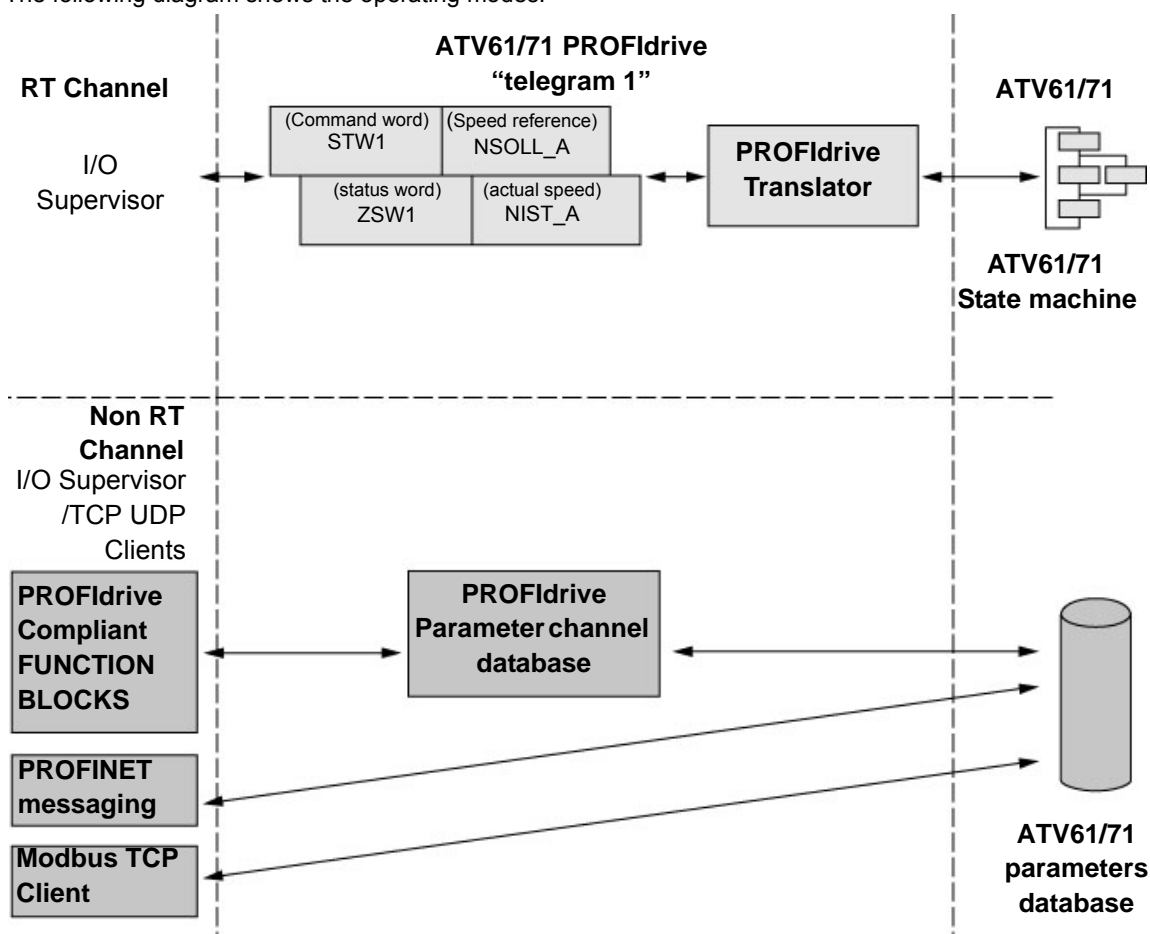

The following section describes how the VW3A3327 is operated when configured in PROFIdrive mode (telegram 1).

The selection of this mode is done while configuring the device with the PROFINET network configuration tool.

It is out of the scope of this document to describe how to use such tool. However, you can find in the examples (see "Configuring an ATV61/71 With a Siemens® S7-300" on page 44) how to configure the card for the Schneider PLCs and for the SIMATIC® S7 PLCs.

Periodic Exchanges

The periodic exchanges, with PROFIdrive application class 1 profile consists of:

- 16 bit command word (STW1) and 16 bit reference word (NSOLL_A),
- 16 bit status word (ZSW1) and 16 bits actual velocity word (NIST_A).

The mapping of these words is automatically done when you select Telegram 1 during the configuration of the device.

Note: After switching from one telegram to another, restart the drive to validate the new configuration.

State Diagram

The following state diagram shows the PROFIdrive state machine for the application class 1. The diagram also describes the command word and status word.

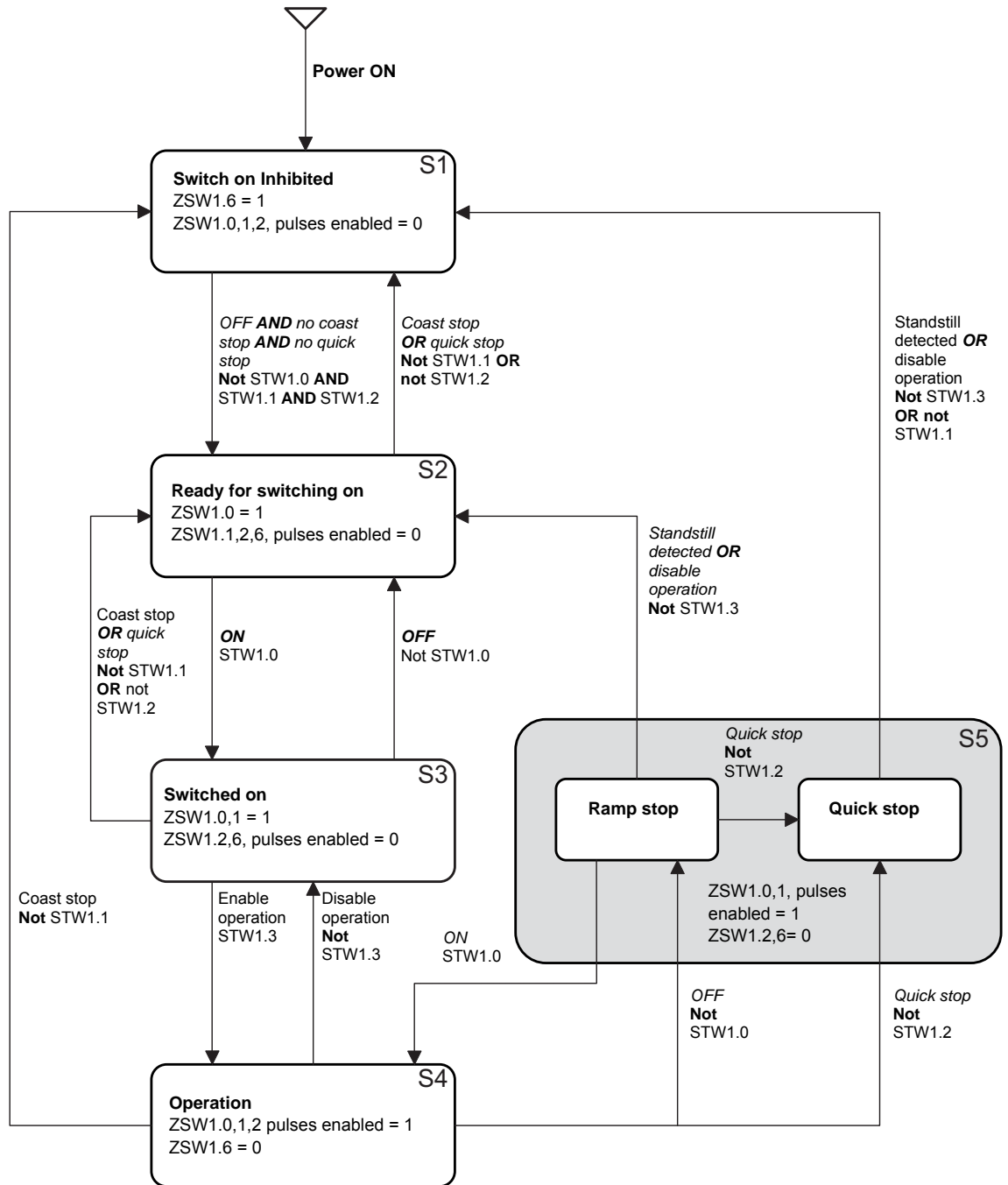

Command Word and Status Word

Overview

The following table lists the command wording from PROFIdrive application profile class 1:

STW1							
Bit 7	Bit 6	Bit 5	Bit 4	Bit 3	Bit 2	Bit 1	Bit 0
Detected fault Acknowledge	–	–	–	Enable operation	Quick stop	Coast stop	ON/OFF
Bit 15	Bit 14	Bit 13	Bit 12	Bit 11	Bit 10	Bit 9	Bit 8
–	–	–	–	–	Control and reference by PLC	–	–

The following table lists the status from PROFIdrive application profile class 1:

ZSW1							
Bit 7	Bit 6	Bit 5	Bit 4	Bit 3	Bit 2	Bit 1	Bit 0
Warning	Switching inhibited	Quick stop Not activated	Coast stop Not activated	Detected fault present	Operation enabled	Ready to operate	Ready to switch ON
Bit 15	Bit 14	Bit 13	Bit 12	Bit 11	Bit 10	Bit 9	Bit 8
–	Reserved	Reserved	Reserved	Reserved	F or n reached or exceeded	Control requested	Speed error within tolerance range

Command Word Details

The following table lists the command wording from PROFIdrive application profile class 1

STW1			
Bit 0	ON	1	“Switched on” condition; voltage at the power converter, that is the main contact is closed (if present).
	OFF (OFF 1)	0	Power-down (the drive returns to the “ready for switching on “ condition); the drive is ramped-down along the ramp (RFG) or along the current limit or along the voltage limit of the d.c. link; if standstill is detected, the voltage is isolated; the main contact is opened (if present). During deceleration bit 1 of ZSW1 is still set. An OFF command is interruptible.
Bit 1	No coast stop	1	All “Coast Stop (OFF2)” commands are withdrawn.
	Coast stop (OFF 2)	0	Voltage is isolated. The main contact is then opened (if present) and the drive goes into the “Switching On Inhibited” condition; the motor coasts down to a standstill.
Bit 2	No quick stop	1	All “Quick Stop (OFF3)” commands are withdrawn.
	Quick stop (OFF 3)	0	Quick stop; if required, withdraw the operating enable, the drive is decelerated as fast as possible. For example, along the current limit or at the voltage limit of the d.c. link, at $n / f = 0$; if the rectifier pulses are disabled, the voltage is isolated (the contact is opened) and the drive goes into the “Switching On Inhibited” condition. A Quick Stop command is not interruptible.
Bit 3	Enable operation	1	Enable electronics and pulses. The drive then runs-up to the setpoint.
	Disable operation	0	The drive coasts down to a standstill (ramp-function generator to 0 or tracking) and goes into the “Switched on” condition (refer to control word 1, bit 0).
Bit 4	Reserved		
Bit 5	Reserved		
Bit 6	Not used		
Bit 7	Detected fault acknowledgement	1	The group signal is acknowledged with a positive edge; the drive reaction to a detected fault depends on the type of detected fault. If the detected fault reaction has isolated the voltage, the drive then goes into the “Switching On Inhibited “ condition.
Bit 8	Not used		
Bit 9	Not used		
Bit 10	Control by PLC	1	Setpoint and control from the bus are active.
	No Control by PLC	0	Setpoint and control from the bus are NOT active.
Bit 11	Reserved		
Bit 12	Reserved		
Bit 13	Reserved		
Bit 14	Reserved		
Bit 15	Reserved		

Status Word

The following table gives the detailed status defined by the ZSW1 command words:

ZSW1			
Bit 0	Ready to Switch ON	1	Power supply is switched on, electronics initialized, main contact, if available, has dropped out, pulses are inhibited.
	Not ready to Switch ON	0	–
Bit 1	Ready to operate	1	Refer to control word 1, bit 0.
	Not ready to operate	0	–
Bit 2	Operation enabled	1	Drive follows setpoint. This means that: <ul style="list-style-type: none"> • the electronic and pulses are enabled (Refer to control word 1, bit 3), • the closed loop control is active and controls the motor, • the output of the setpoint channel is the input for the closed loop control.
		0	Either the pulses are disabled or the drive does not follow the setpoint.
Bit 3	Detected fault present	1	Unacknowledged detected faults or currently not acknowledge able detected faults (fault messages) are present (in the fault buffer). The detected fault reaction is fault-specific and device-specific. The acknowledging of a detected fault may only be successful if the detected fault cause has disappeared or has been removed before. If the detected fault has isolated the voltage, the drive goes into the “Switching On Inhibited” condition, otherwise the drive returns to operation. The related detected fault numbers are in the detected fault buffer.
	No detected fault present	0	–
Bit 4	Coast stop not activated	1	–
	Coast stop activated	0	Coast Stop (OFF 2) command is present.
Bit 5	Quick stop not activated	1	–
	Quick stop activated	0	Quick Stop (OFF 3) command is present.
Bit 6	Switching inhibited	1	The drive goes only again in the “Switched On” condition with “No Coast Stop AND No Quick Stop” followed by “ON”. This means that the “Switching On Inhibited” bit is only set back to zero if the OFF command is set after “No Coast Stop AND No Quick Stop “.
	Switching not inhibited	0	–
Bit 7	Warning present	1	Warning information present in the service/maintenance parameter; no acknowledgement.
	No warning	0	–
Bit 8	Speed detected error within tolerance range	1	Actual value is within a tolerance band; dynamic violations are permissible.
	Speed detected error out of tolerance range	0	–
Bit 9	Control requested	1	The automation system is requested to assume control.
	No Control requested	0	Control by the automation system is not possible, only possible at the device level, by another interface or the drive is controlled from a supervisor (Master class 2).
Bit 10	F or n reached or exceeded	1	Actual value \geq comparison value (setpoint) which may be set via the parameter number.
	F or n not reached	0	–
Bit 11	Reserved		
Bit 12	Reserved		
Bit 13	Reserved		
Bit 14	Reserved		
Bit 15	Reserved		

Speed Setpoint

Speed Setpoint Channel

The speed setpoint, written in NSOLL_A, gives a frequency output defined by the following formula:

$$\text{Speed setpoint in Hz} = (\text{NSOLL_A} \times [\text{Max frequency}] (f_r)) / 16\#4000$$

[Max frequency] (f_r): Normalized frequency of the ATV61/71 (typically 50 Hz).

Speed Setpoint Range

The following table lists the different values for the speed references and the correspondence for ATV61/71:

Setpoint value	Setpoint used by the Altivar 61/71
0x0000	0
0x4000	100% of normalized frequency
0xC000	-100% of normalized frequency

PROFIdrive / Acyclic Messaging

See “Annex B - The PROFIdrive Parameters Channel” on page 75.

Embedded Webserver



What Is in this Chapter?

This chapter contains the following topics:

Topic	Page
Overview	58
Connection to the Webserver	58
Pages Description	59
FTP SERVER	65

Overview

The VW3A3327 provides an integrated web server which allows several functions like: monitoring, parameter settings, and diagnostics. This chapter describes the services provided by this webserver.

The webserver can be accessed from standard Browsers like Internet Explorer or Firefox.

Connection to the Webserver

The webserver can be accessed from standard browsers like Internet Explorer or Firefox.

In the following example, the ATV61/71 has received the IP address 10.0.0.5:



First connect the computer to the ATV61/71 by typing `http://` followed by the ATV61/71 IP address.

You will be asked to first enter a User Name and a password.

By default the user name is USER and the password is also USER.

Once connected, the webserver home page is displayed.

Access Rights - Password and User Names

- “Web read password”: Access to the different pages requires a User access level. This is the first level of password, you can monitor and access to all the pages of the webserver, but not modify data.
 - User name: USER (default value)
 - Password: USER (default value)
- “Web write password”: Access to data or settings change, an Administrator access level is required.
 - Password: USER (default value).

The user names and the password of both level can be modified from the administration section (> home > Network Setup > Administration).

Web Server Site Map

that contains

Home	Monitoring	Drive monitor (page 60) Data Viewer/Editor (page 61) Save and restore (page 62)
	Network setup	Network Parameters (page 63) iPar client settings (page 63) Administration (page 63)
	Diagnostics	TCP/IP statistics (page 64) Modbus Statistics (page 64)

Pages Description

Home Page

The home page or “Home” menu includes a “**Languages**” submenu that contains a link to the different available languages page.

Each link in the “Languages” submenu sends the user to the home page in the chosen language and configures the web browser to open the HTML pages located in the corresponding directory.

(example: the “http://139.160.69.241/html/english/” directory becomes the standard directory in the case of English).

Note About Java Applets

The Webserver downloads Java programs called “applets” to your computer. These applets communicate with the drive using Modbus services (on port 502), thus establishing one or more connections between the computer and the drive. Until an applet has been fully transmitted from the drive to the browser, a gray rectangle appears in the place reserved for it in the page.

The applets associated with the web pages monitor communication with the drive. When the drive no longer responds to requests to update the data, the message “Link down” is displayed in one field and all the other field contents are emptied.

The description of each page indicates the data refresh period requested by the applet loaded on the computer. The refresh period actually observed depends on:

- The performance of the computer on which the web browser is running,
- The communication system response time,
- The amount of data to be refreshed on the page.

Monitoring Menu

The “Monitoring” menu contains the following items:

- A link to the “**Drive Monitor**” page:

Station Name	atv71-1	LI1	LI7	AI1	7.044	R1
Device Name	atv71	LI2	LI8	AI2	3.883	R2
Altivar Status	NLP	LI3	LI9	AI3	0.0	R3
Device Ref.	ATV71H075M3	LI4	LI10	AI4	0.0	R4
		LI5	LI11	AO1	0.0	LO1
		LI6	LI12	AO2	0.0	LO2
			LI13	AO3	0.0	LO3
			LI14			LO4

FRH Freq. Ref.	Hz	35.2
RFR Output Freq.	Hz	0.0
OTR Output Torque	%	0.0
ULN Mains Voltage	V	0.0
UOP Motor Voltage	V	0
LCR Motor Current	A	0.0
THD Drive Thermal	%	0
THR1 Motor Thermal	%	0
OPR Output Power	%	0
APH Power Used	kWh	0.0
RTH Run Time	h	0.0

The state displayed in the “Altivar State” field corresponds to the display on the drive integrated display terminal. A delay may sometimes be noticed between the displays on the Web server and the display terminal. This delay depends on the performance of the computer used to display the pages using a Web browser and the communication system performance.

The motor speed displayed on the “Motor Speed” gauge is calibrated according to the maximum frequency **[Max frequency] (F_r)** and the number of pairs of poles **[Pr] (P_p)**.

The LI... area gives the state of the drive terminals (logic inputs LI1 to LI16, logic outputs LO1, relay outputs R1 to R2, analog inputs AI1 to AI3 and analog output AO1. When a logic input is active, the LED is green. When a logic output is active, the LED is red.

- A link to the "Data viewer/ editor" page:

Data Viewer/Editor

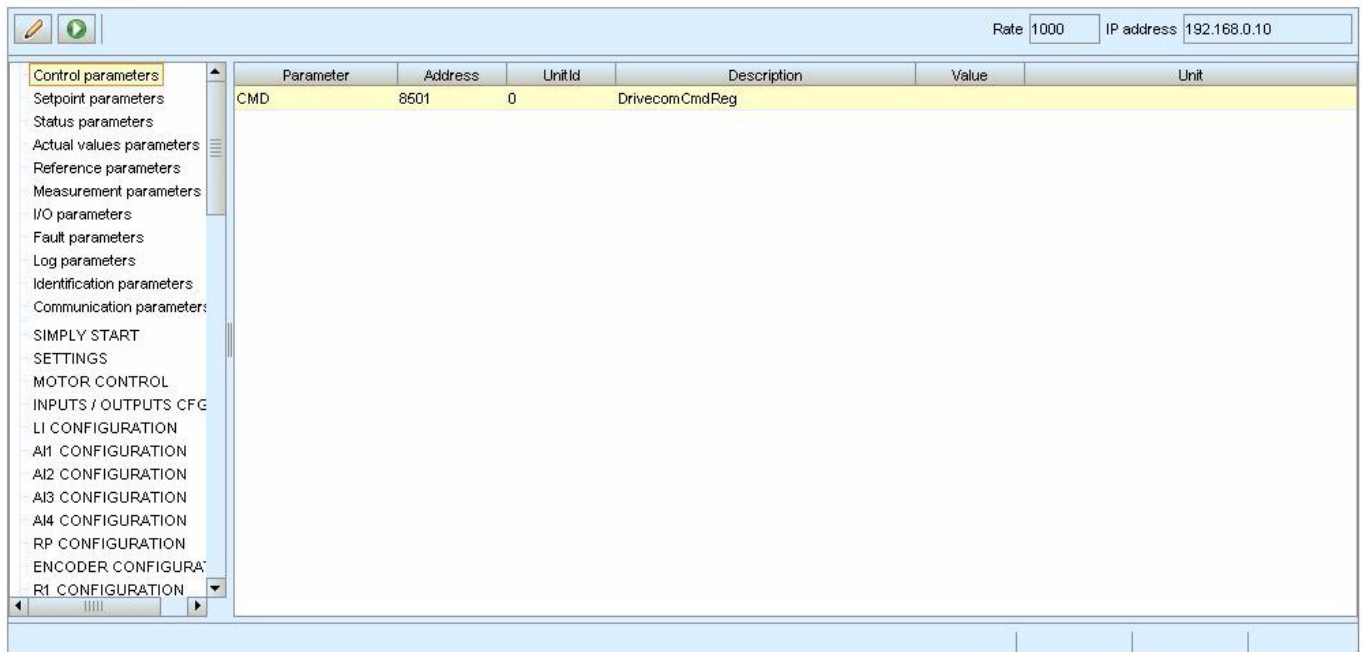

This page is used to display the drive parameters and to modify their values.

The parameters are arranged in groups, and are consistent with the keypad and user manuals.

The display mode for each value depends on the nature of the parameter:

- The unit for the physical values is displayed in the "Unit" column.
- The registers (bit fields) are displayed in hexadecimal format (16#xxxx).
- Signed values are displayed as such.

To begin the monitoring, click the "Start animation" button:

To modify the parameter value, click the "Write value of selected row" button then select the parameter to modify.

It is only possible to modify the parameter values after entering the "Write password" (see "Access Rights - Password and User Names" on page 58). Click the "Password" button to enter this password. An entry field then appears in the parameter table, and also a "Cancel" button, for canceling the password entry. After entering the password, press the Enter key so that it is taken into account by the web browser.

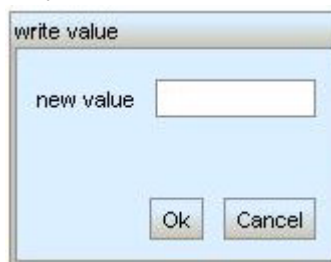

When the value of a parameter cannot be modified, the following window appears: "This parameter can't be written!".

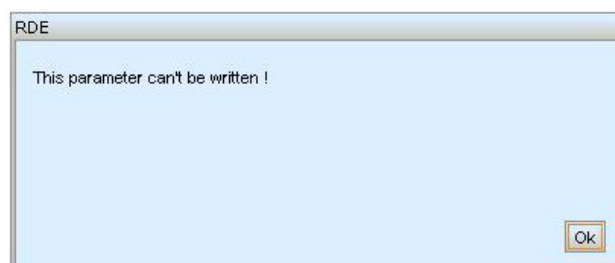

Save and restore configuration

- A link to the "Save and restore configuration" page:

Save the configuration setting from the drive

Restore the configuration file to the drive

File :

Copyright © 1998 - 2011, Schneider Electric. All Rights Reserved.

This page is used to save on the local computer (save "Backup.cfg" file) and restore from the local computer the drive parameters by using the embedded webserver. Restore operation is possible when the motor is stopped.

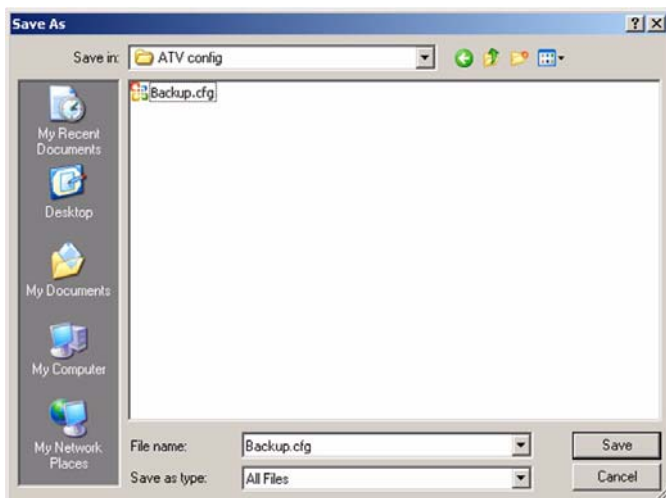

Save as

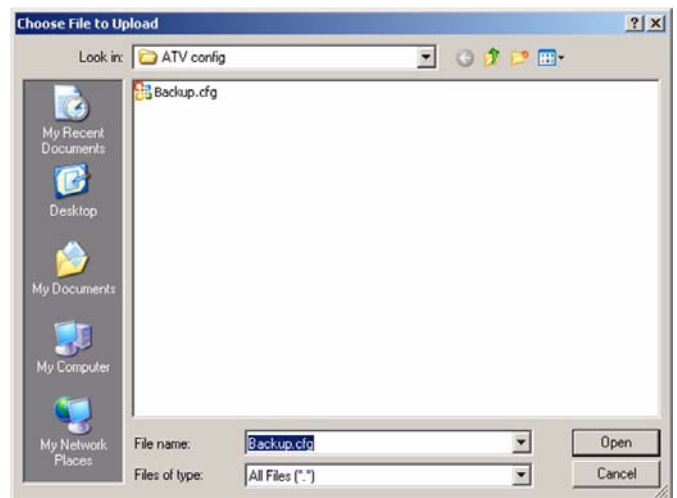

Restore

Network Setup menu

The "Network setup" menu contains the following items:

- A link to the "**Network Parameters**" page:

Network Settings	
Profile	Telegram 1
IP Mode	Manual
IP address	192.168.0.10
Subnet mask	255.255.0.0
Gateway address	0.0.0.0
Device Name	
Station Name	atv71-1
<input type="button" value="Save"/> <input type="button" value="Abort"/> <input type="button" value="Password"/>	

- A link to the "**iPar client settings**" page:

This page displays the main parameters used by the VW3A3327 PROFINET card iPar function and is used to configure these parameters. See the "iPar Service" chapter in this section for more information.

Ipar Configuration		Ipar Status	
Ipar State	0: IDLE	Device Reference	ATV71H075M3
Validation	ON	Error code	0: No fault
Local Config.	ON	Save counter	0
Error mgt.	ON	Restore Counter	0
AutoSave	OFF		
Period (minute)	9999		
<input type="button" value="Save"/> <input type="button" value="Restore"/>			
<input type="button" value="Save file"/> <input type="button" value="Restore file"/> <input type="button" value="Reset counter"/> <input type="button" value="Password"/>			

- A link to the "**Administration**" page:

This page is used to modify the Web read and the web write password. See Access Rights - Password and User Names on page 58.

Administration	
Web read password	<input type="text"/> <input type="button" value="Save"/>
Web write password	<input type="text"/> <input type="button" value="Save"/>
<input type="button" value="Abort"/> <input type="button" value="Password"/>	

Diagnostics menu

The "Network setup" menu contains the following items:

- A link to the "TCP/IP Statistics" page:

This page gives detailed information about the Ethernet status and settings.

TCP/IP parameters		Receive statistics	
IP address	192.168.0.10	Frames received OK	27
Subnet mask	255.255.0.0	CRC errors	0
Default gateway	0.0.0.0	Transmit statistics	
IP Mode	Manual	Frames transmitted OK	26
Ethernet parameters		Collisions	0
MAC address	80-00-D9-F4-8C-00	Carrier sense errors	0
Ethernet frame format	Ethernet II, IEEE 802.3 sender, IEEE 802.3 receiver	Excessive collisions	0
		Late collisions	0

[Reset counters](#)

- A link to the "Modbus Statistics" page:

This page gives detailed information about the Modbus server.

Inbound/Outbound Statistics	
Opened TCP Connections	1
Send Modbus msg	6745
Received Modbus msg	6745
Modbus error message	0

[Reset Counters](#)

FTP SERVER

An FTP server gives access to the resources of the web server files:

-The access is restricted by username and password.

-Login default values are: username = USER; password= USER. The write password can be changed on the default web server.

-The FTP server allows up to 2 simultaneous connections.

-The FTP server contents cannot be modified if the motor is running.

The FTP server has a DOS type file system.

The FTP server allows the following operations

FTP function	
User name control. Allows or refuse connection	OK
Password control. Allows or refuse connection	OK
User logout	OK
File system type:	OK; "DOS"
Creation of a volume	Not managed
Rename file	OK
Open file	OK read/write
Read file	OK
Write file	OK
Open folder	OK
Close folder	OK
Change folder	OK
Current folder = parent folder	OK
Delete folder	OK
Create folder	OK
Recuperation of the current folder	OK
Read next folder entry	OK

Common Additional Features



9

What Is in this Chapter?

This chapter contains the following topics:

Topic	Page
Identification and Maintenance Data	68
I&M Records Description	68

Identification and Maintenance Data

Identification & maintenance (I&M) has been established to the PNO. “Support the end user during the various scenario of the device lifecycle”:

- Configuration
- Commissioning
- Repair and update
- Operation and visualization

NOTE: These fields are read only (index 16#AFF0).

The access to the I&M records is achieved by the use of the PROFINET mechanisms (IEC 611458-6).

I&M Records Description

Champ	Number of bytes	Value	Meaning
HEADER_MANUF_SPEC	10	(string)	Manufacturer specific field
MANUFACTURER_ID	2	16#01, 16#29	16#129: Schneider Electric
ORDER_ID	20	Identification object ID 1	Commercial part number of the drive
SERIAL_NUMBER	16	Serial number	C1P1, C1P2, C1P3, C1P4
HARDWARE_REVISION	2	16#10, 16#00	–
SOFTWARE_REVISION	4	'V', A, B, C	A = MSB of software version B = LSB of software version C = MSB of software revision
REVISION_COUNTER	2	16#xx, 16#yy	Rev xy
PROFILE_ID	2	–	Defined by the PNO (3A00..3AFF, PROFIdrive)
PROFILE_SPECIFIC_TYPE	2	–	Profile specific number
IM_VERSION	2	16#01, 16#01	Version I&M: 1.1
IM_SUPPORTED	2	16#00, 16#01	Managed Index I&M → I&M0

The ORDER_ID contains the commercial part number of the drive.

Annexes

10

What Is in this Chapter?

This chapter contains the following topics:

Topic	Page
Annex A - Simple CONT Language FC (Controlling the Drive in CiA402 Mode)	70
Annex B - The PROFIdrive Parameters Channel	75
Glossary	82

Annex A - Simple CONT Language FC (Controlling the Drive in CiA402 Mode)

Block: FC1

Network: 1

rising edge on start command

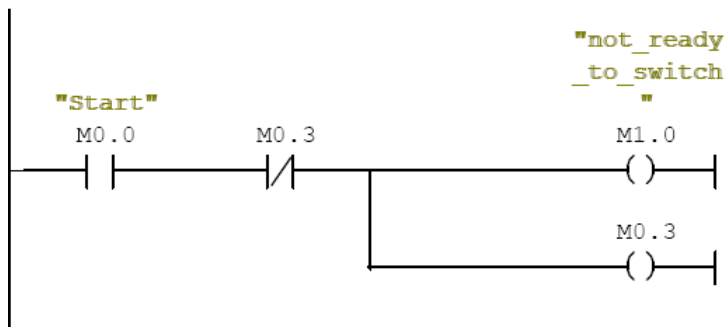

Network: 2

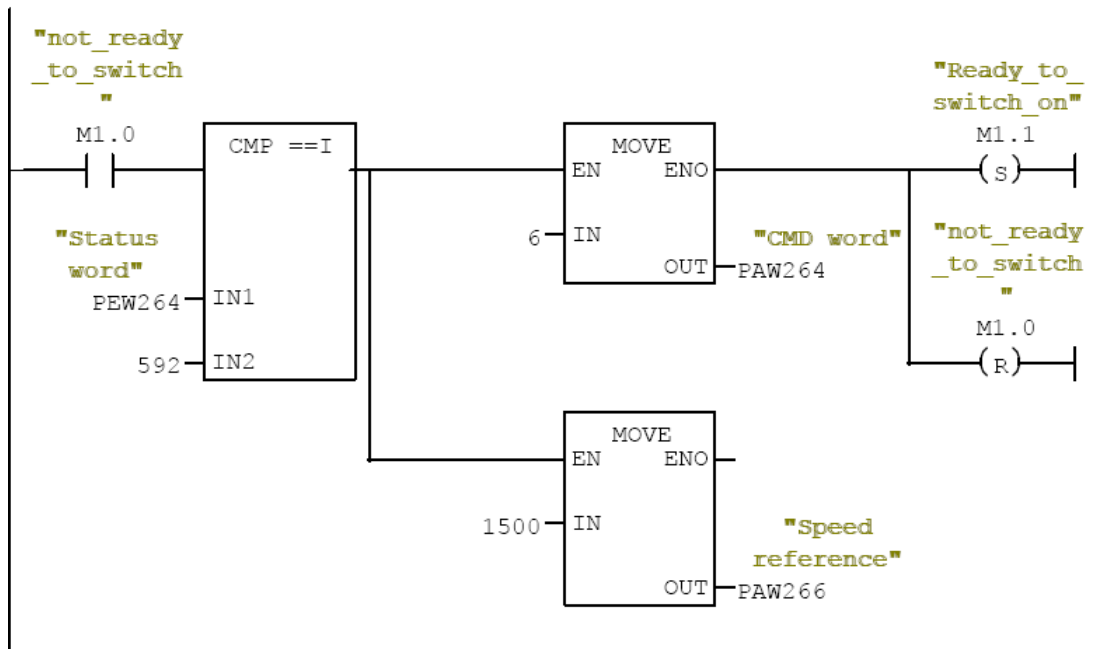

Network: 3

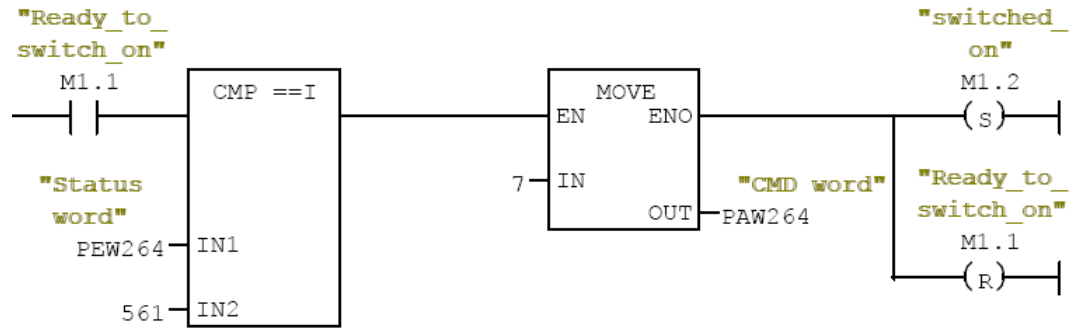

Network: 4

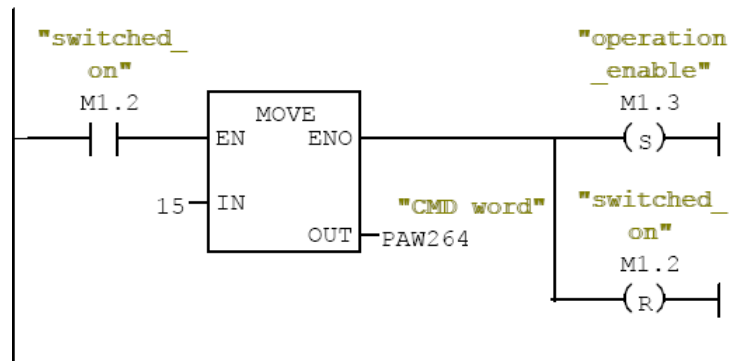

Network: 5

Tempo forward

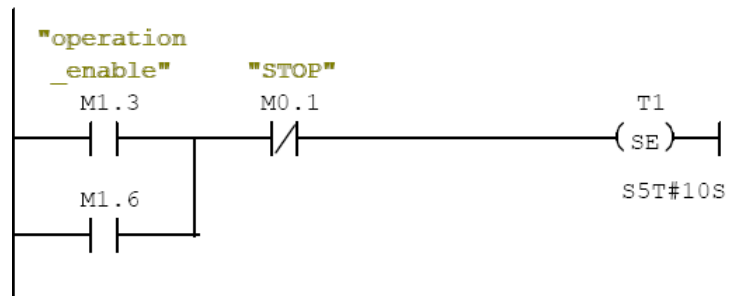

Network: 6
 Rising edge Tempo

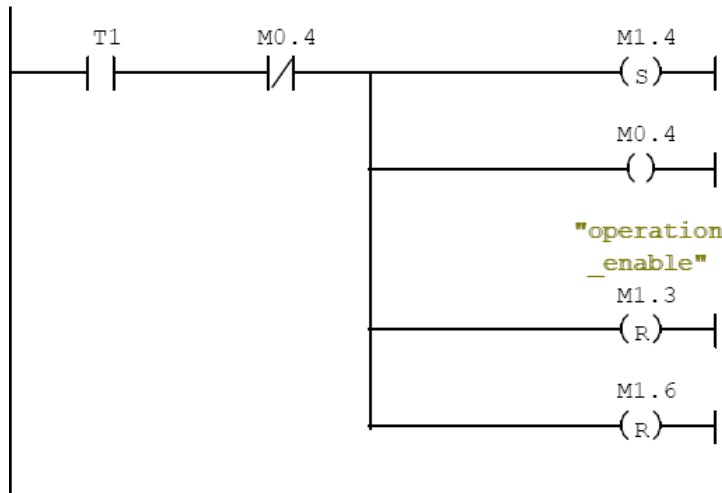

Network: 7
 RAMP STOP

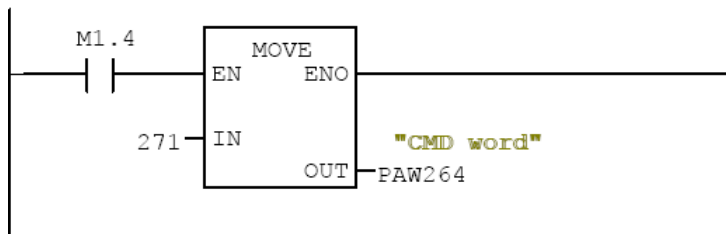

Network: 8

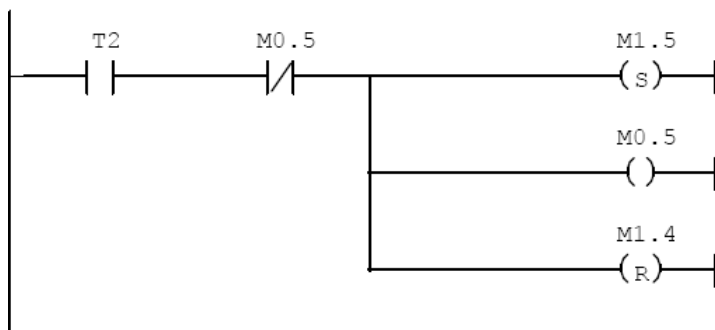

Network: 9

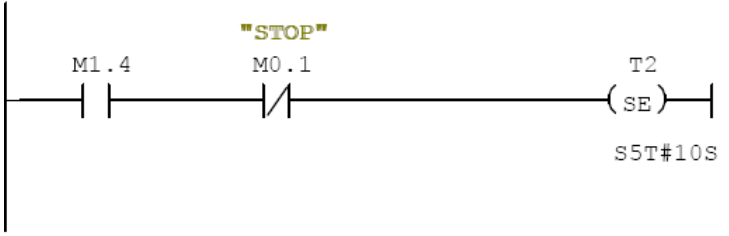

Network: 10

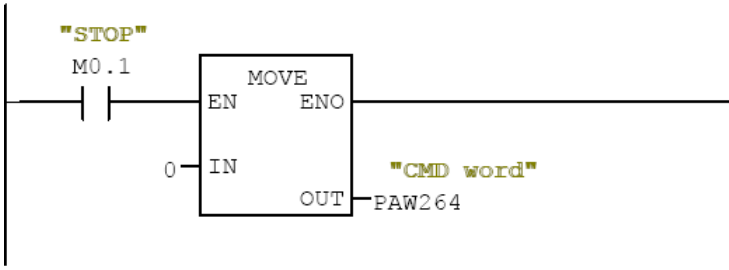

Network: 11

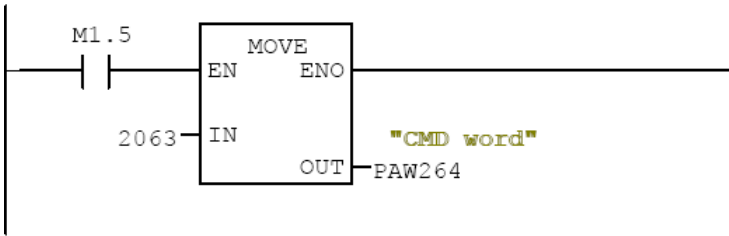

Network: 12

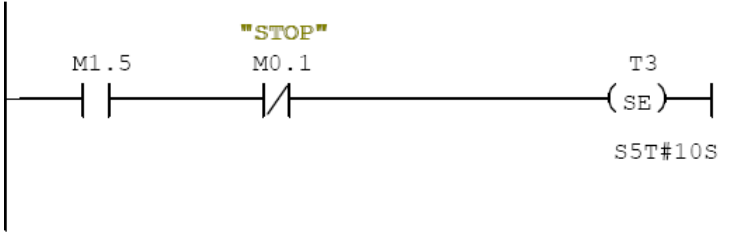

Network: 13

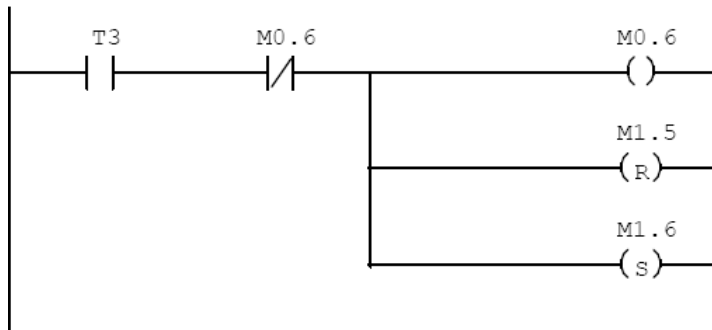

Network: 14

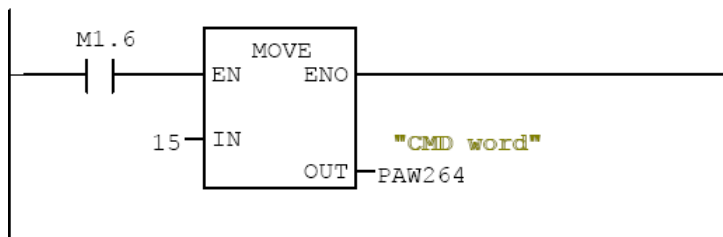

Annex B - The PROFIdrive Parameters Channel

When operated with the PROFIdrive profile, the Altivar 61/71 parameters are organized as defined by PNU numbering and addressing modes. However, for people who are familiar with the ATV parameters, this addressing mode keeps the native structure of the device (based on Modbus addressing). PNU are numbered from 0 to 65535 and each PNU represents a parameter (from single type as words to complex data structure or arrays). PROFIdrive parameters from PNU 900 to PNU 999 are standardized, they are described below. All others PNUs are manufacturer-specific.

In the case of the Altivar 61/71, parameters can be separated in 2 groups:

- Standardized PNUs (900 to 999)
- ATV61/71 parameters which are gathered in a single PNU entry point: PNU1000.

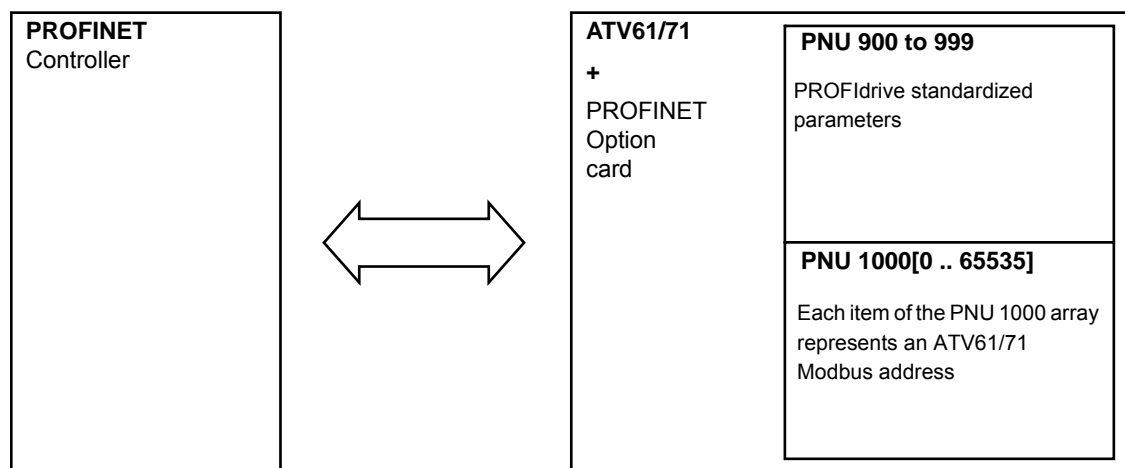

PROFIdrive Based on PROFINET

When the Altivar 61/71 is operated in PROFIdrive profile, the parameter management takes benefit of the PROFINET acyclic messaging features: With PROFINET, it is possible to exchange messages of variable length between the controller and the supervisor. These messages come in addition of the periodic data exchange.

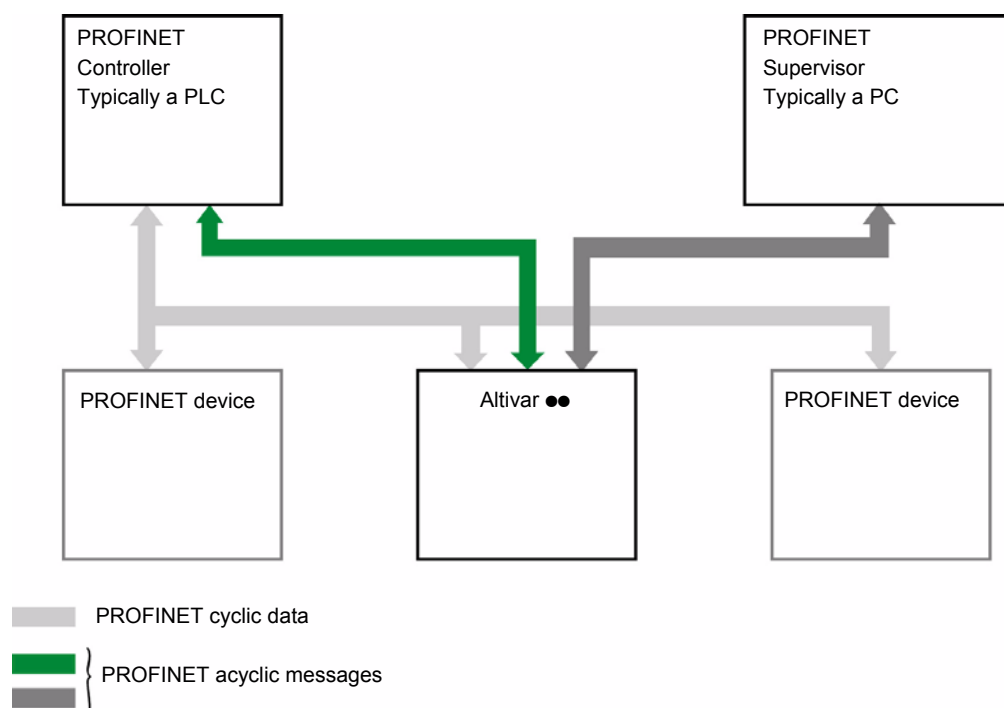

PROFdrive Telegram:

The following table describes the Profdrive header:

DU	Byte nr	Request
Function code	0	
Slot_num	1	0: global parameters
Index	2	47: Reserved for PROFdrive
Length	3	Length of PROFdrive parameter channel frame
Data	4-5	PROFdrive parameter channel frame: check

PROFdrive Parameters Structure

A parameter is defined with its PNU number from 1 to 65535.

Each parameter is made of 3 main areas: **PWE** — the value —, **PBE** — which describes the parameter attributes —, and a text area. The access to the 3 different areas of a parameter is specified by the “attribute field” of the parameter request. The following diagram summarizes the parameter model (For more information, refer to the Profile drive technology V4 standard).

The parameters and their sub parts are identified as follows:

PNU number + Attribute	16#10	PWE	+ Sub_index
	16#20	PBE	+ Sub_index
	16#30	Text	+ Sub_index

Detail of the PBE Attribute

The following diagram describes the PBE attribute:

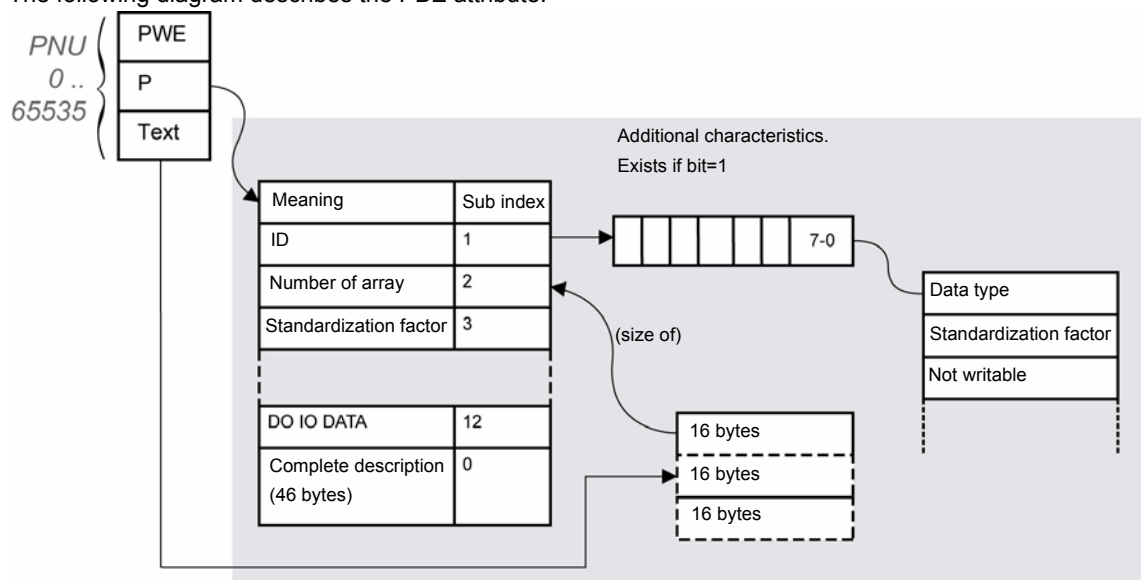

Altivar 61/71 Parameters

Each Altivar 61/71 parameter can be represented according to the PNU standard structure. The following table gives the possible values of a parameter according to the PNU properties. Altivar 61/71 parameters are part of the PNU 1000. PNU 900 to 999 are described in the “PROFdrive Standard Parameters” on page 77.

parameter property	Altivar 61/71 implementation	Example
PNU number	1000	–
Sub index	Modbus address	[CMD address] (8501)
PWE	Value of the parameter 0..65535	–
PBE	Describes an array of 65535 Words	Constant
Text	–	“Altivar 61/71 parameter”

PROFIdrive Standard Parameters

Parameters 900 to 999 are defined in accordance with the PROFIdrive profile.

The following table describes the required parameters.

PNU	Sub ID	Definition	Type	R/W	Comment
900	–	Controller > DO PNU900 contains the cyclical frame if Supervisor handles the DO	–	R	Control telegram. Image of PZD
907	–	Controller < DO PNU900 contains the cyclical frame if Supervisor handles the DO	–	R	Status telegram. Image of PZD
922	–	Telegram selection	UINT	R	1, 100
927	–	Operation priority	UINT	R/W	Enables control
928	–	Control priority	UINT	R	= 1
930	–	Operating mode	UINT	R	= 1
944	–	Fault message counter	UINT	R	The value of PNU944 is incremented each time a detected fault occurs.(+1 for each new detected fault)
947	–	Detected fault number	UINT	R	If a detected fault has been triggered by the Altivar, this parameter contains the detected fault code value. (detected fault code = detected fault number)
963	–	Actual baud rate	UNIT	R	Current baud rate
964	–	Drive unit identification			
	0	Manufacturer ID	–	R	Defined by PNO (PROFINET Organization)
	1	Drive unit	String	R	This UNIT contains the value xx commercial part number (character string)
	2	Version (drive)	–	R	This parameter contains the Firmware version of the host drive XXyy version, IE
	3	Firmware date (year)	INT	R	–
	4	Firmware date (day/month)	INT	R	This parameter contains the firmware date (day/month)
	<i>PNO also defines SubID 5 and 6, but they shall not be implemented.</i>				
965	–	Profile identification number	UINT	R	Profile identification numbers: Byte 1 = 03: PROFIdrive Byte 2 = 40: V4.01

Parameters Requests

There are 2 kinds of requests:

- Request parameter (parameters are PNU number, attribute, and Sub_index)
- Change parameter (parameters are PNU number, attribute, and Sub_index)

These requests are able to manage one or more parameters or several attributes of one parameter. In order to access to a specific attribute of a parameter, the request header contains: the PNU, the sub-ID, and an attribute. This attribute defines whether the request mentions the value, the description area, or the Text area.

Parameter Reading

- Request:

	Byte n+1	Byte n
	Request reference = 01	Request ID = 01
Request data (1st parameter)	Axis = 16#01	Number of parameters = 01 to n (n: number of parameter in the request)
	Attribute = 16#10 *	Number of elements = 1
	PNU number = 3E8	
	Sub index = 16#C81 (3201) ETA Modbus Address	
Request data (2nd parameter)	Attribute = 16#10 *	Number of elements = 1
	PNU number = 16#3E8	
	Sub index = Modbus address of the second parameter	

Request data (nth parameter)	Attribute = 16#10 *	Number of elements = 1
	PNU number = 16#3E8	
	Sub index = Modbus address of the nth second parameter	

*Refers to field "value" (PWE), 16#20 refers to the description field (PBE) and 16#30 to the text field.

- Response (in case of the request contents is made of a single parameter):

	Byte n+1	Byte n
Response Header	Request reference = 01	Request ID = 01
	Axis = 16#01	Number of parameters = 01
Response data	Format = 16#42 *	Number of elements = 01
	PNU value = 16#xxxx (value of ETA)	

*Format 16#42 specified that the returned value is a WORD.

Note: Byte 16#41, Word 16#42, standard integer 16#03, Double word 16#43.

Parameter Writing

- Request:

	Byte n+1	Byte n
Request Header	Request reference = 01	Request ID = 02
	Axis = 16#01	Number of parameters = 01
Parameter number	Attribute = 16#10 *	Number of elements = 01
	PNU number = 16#3E8	
	Sub index = 16#2329 (9001) ACC Modbus Address	
Parameter value	Format = 16#42	Amount values = 01
	Value = 50 (ACC is set to 5 s)	

* Refers to field "value", 16#20 refers to the description field and 16#30 to the text field.

This request can also be used for writing multiple parameters.

- Response (if OK):

	Byte n+1	Byte n
Response Header	Request reference = 01	Request ID = 02
	Axis = 16#01	Number of parameters = 01

Request: Negative Response

The following table lists the items of a negative response:

	Byte n+1	Byte n
Response Header	Request reference = 01	Response ID = 82 *
	Axis = 16#01	Number of parameters = 01
Parameter number	Format = Error 16#44	Number of values
Value	Error Value Meaning 16#xxxx 0x00 Impermissible PNU 0x01 cannot change value + Subindex 0x02 Low or high limit exceeded + Subindex 0x03 Subindex detected fault + Subindex 0x04 No array 0x05 Incorrect data type 0x06 Setting not permitted + Subindex 0x07 Cannot change description + Subindex 0x09 No description 0x0B No operation priority 0x0F No text array available 0x11 Cannot execute the request. Reason not specified 0x14 Value impermissible 0x15 Response too long 0x16 Parameter address impermissible 0x17 Illegal format 0x18 Number of values inconsistent 0x19 Axis/DO nonexistent 0x20 Cannot change text 0x65 Invalid Request Reference 0x66 Invalid Request ID 0x67 Invalid Axis number / DO-ID 0x68 Invalid number of parameters 0x69 Invalid attribute 0x6B Request too short	

* For all negative responses the ID equals to response code or 16#80.

With the Subindex in addition to the error value, the total length of the answer is 10 bytes.

Annex C - iPar Service

The PROFINET communication option board is compliant with iPar server function.

This is managed by the function block FB24 "IPARSERV".

The purpose of this function is to save (upload) the parameters (iParameter) of any PROFIBUS DP slave, PROFINET I/O device, or module within the same host controller that is maintaining the GSD-based parameters and diagnosis messages.

This allows, for example, fast device replacement due to maintenance or repair.

The function block can restore (download) the iParameter set to the component upon its request.

The principle is shown on the figure below; circled numbers are presenting the actions.

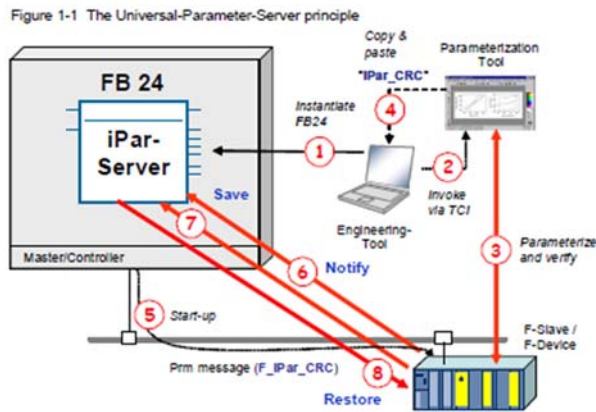

Per upload request, the function block reads the data record with the iParameter out of the drive, creates a data block, and stores the data record therein.

Per download request, the function block uses the data block and writes down a data record to the drive.

The FB is instantiated once per component. It must be invoked within OB1 and additionally in OB 100 (the start-up OB).

With PROFINET I/O, a device sends a request to save or restore iParameter set to the host controller via a new "ALARM", called "Upload&Retrieval" (UserStructureIdentifier = 0x8201).

With a PROFINET I/O device, the function block FB 24 must additionally be invoked within OB 56 (the "Update Alarm" OB).

To configure iPar function, the Diagnostic address of Slot 0 of the device shall be used.

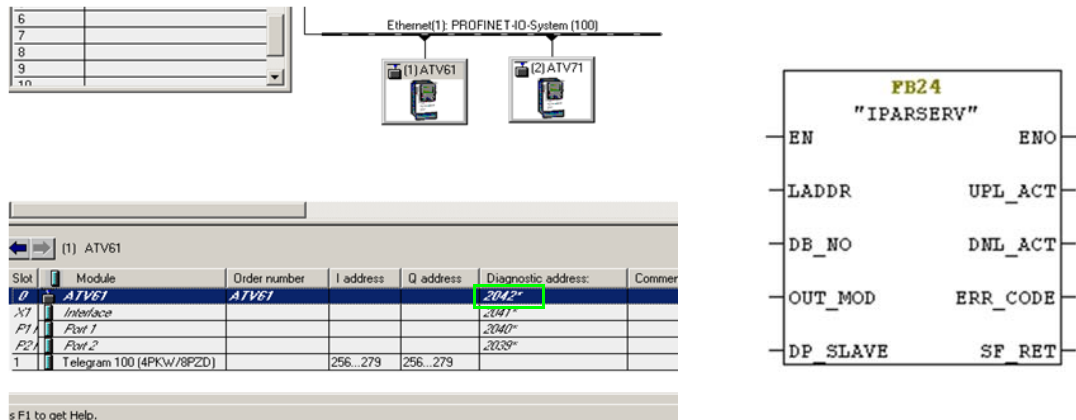

iPar function activation is done in the hardware configuration by checking "Support device replacement without exchangeable medium":

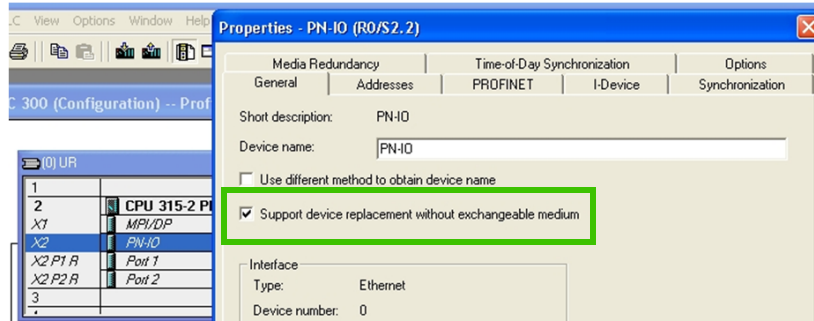

The answer of the iPar request is stored in a data block. The size of the array shall be set to 8192.

Address	Name	Type	Initial value
0.0		STRUCT	
+0.0	DB_VAR	BYTE	B#16#0
+1.0	DB_VAR1	BYTE	B#16#0
+2.0	DB_VAR2	DWORD	DW#16#0
+6.0	DB_VAR21	ARRAY[0..8192]	
*1.0		BYTE	
=8200.0		END_STRUCT	

Glossary

ADL	Logical address
CNF	Communication Network failure
DCP	Discovery Control Protocol - A communications protocol with PROFINET I/O that allows an I/O Controller or Supervisor to find and configure every PROFINET I/O device on a subnet.
GSDML	Generic Station Description Markup Language - The file containing the XML description of the PROFINET IO device.
ILF	Internal detected fault
LLDP	Link layer Discovery Protocol
MRP	Media Redundancy Protocol
PKE	Parameter identifier
PKW	Parameter - Parameter Index - value
PNO	PROFINET Organization
OB	The PROFINET option board

