

Eurotherm[®]

by Schneider Electric

6100A/6180A
User Guide

6100A/6180A Paperless graphic recorder
up to Versions 5.10

HA028910/17
Dec 2021

This certificate relates to the product models mentioned above. The data shown here is related to the following version of the China RoHS 2.0: Administrative Measures for the Restriction of Hazardous Substances in Electric Appliances and Electronic Products" released January 21st 2016.

部件名称 Part Name	有害物质 - Hazardous Substances					
	铅 (Pb)	汞 (Hg)	镉 (Cd)	六价铬 (Cr (VI))	多溴联苯 (PBB)	多溴二苯醚 (PBDE)
金属部件 Metal parts	0	0	0	0	0	0
塑料部件 Plastic parts	0	0	0	0	0	0
电子件 Electronic	X	0	0	0	0	0
触点 Contacts	0	0	X	0	0	0
线缆和线缆附件 Cables & cabling accessories	0	0	0	0	0	0

本表格依据SJ/T11364的规定编制。

O: 表示该有害物质在该部件所有均质材料中的含量均在GB/T 26572规定的限量要求以下。

X: 表示该有害物质至少在该部件的某一均质材料中的含量超出GB/T 26572规定的限量要求。

This table is made according to SJ/T 11364.

O: indicates that the concentration of hazardous substance in all of the homogeneous materials for this part is below the limit as stipulated in GB/T 26572.

X: indicates that concentration of hazardous substance in at least one of the homogeneous materials used for this part is above the limit as stipulated in GB/T 26572

Signed (Kevin Shaw, R&D Director):



Date: 24th June 2016

PAPERLESS GRAPHIC RECORDER

USER GUIDE

LIST OF SECTIONS

Section	Page
1 INTRODUCTION	2
2 INSTALLATION	2
3 PROCESS VARIABLE DISPLAY	14
4 SETTING UP THE RECORDER	51
5 FILE	253
6 BRIDGE	256
7 SCREEN BUILDER	265
8 MODBUS TCP SLAVE COMMS	293
9 ANALOGUE OUTPUT OPTION	345
10 EVENT INPUT OPTION	347
11 TRANSMITTER POWER SUPPLY	348
12 ASCII PRINTER OUTPUT OPTION	351
13 PORTABLE CASE OPTIONS	363
14 REMOTE CJ BLOCK OPTION	376
15 THERMAL UNIFORMITY SURVEY (TUS) OPTION	386
ANNEX A: SPECIFICATION	390
ANNEX B: REFERENCE	400
ANNEX C: WEB SERVER DETAILS	430
INDEX	434

EFFECTIVITY

This manual refers to recorders using software, up to version 5.10. To determine the software version fitted to the recorder, the 'About' screen may be accessed as described in [section 4.6.11](#).

ASSOCIATED DOCUMENTS

HA033523U002 Customer Advisory: 6000 Series Paperless Chart Recorder enhanced for Cyber-security Robustness.

PAPERLESS GRAPHICS RECORDER USER GUIDE

LIST OF CONTENTS

Section	Page
SAFETY NOTES	1
SYMBOLS USED ON THE RECORDER LABELLING	1
1 INTRODUCTION	2
1.1 UNPACKING THE RECORDER	2
2 INSTALLATION	2
2.1 MECHANICAL INSTALLATION	2
2.2 ELECTRICAL INSTALLATION	5
2.2.1 Signal wiring	5
CONNECTOR WIRING DETAILS	5
2.2.2 Supply voltage wiring	9
LINE SUPPLY	9
LOW VOLTAGE SUPPLY OPTION	9
2.3 ACCESS FLAP	10
2.3.1 Stylus	11
2.3.2 Card slot	11
LED INDICATORS	11
2.3.3 USB Front Port	11
2.4 LOCKABLE FLAP OPTION	12
2.4.1 Flap lock operation	12
ARCHIVE INACTIVE	12
ARCHIVE ACTIVE	13
3 PROCESS VARIABLE DISPLAY	14
TRUNCATION OF NUMERIC VALUES	14
CURRENT TRACE ALARM ICONS	15
3.1 STATUS BAR	15
3.1.1 Current access level	15
3.1.2 Page name	15
3.1.3 Alarm indication	16
INSTRUMENT ALARM	16
CHANNEL ALARM	18
CHANGE BATTERY	18
DISK ICON	18
FTP ICON	18
CONFIGURATION LOCKED INDICATOR	18
TRIAL MODE INDICATOR	18
3.1.4 Summary menu	19
INSTRUMENT ALARM SUMMARY	19
ACK ALL ALARMS	19
ALARM SUMMARY PAGE	20
ALARM ACKNOWLEDGEMENT	21
BATCH SUMMARY	22
MESSAGE LOG	24
MESSAGE TYPE FILTER	25
PERIOD FILTER	25
OPTION MENU	26
REMOVE MEDIA	27
3.2 NAVIGATION KEYS	28
3.2.1 Key functions	28
ROOT MENU KEYS	28
3.3 FIRST SWITCH-ON	30
3.3.1 Initial Setup	30
Security levels	31
3.3.2 Access to Configuration	32
TROUBLE SHOOTING	33
TEXT STRING ENTRY	33
3.4 DISPLAY MODES	35
TREND HISTORY	35
TIME CHANGE RECORDS	36

LIST OF CONTENTS (CONT.)

Section	Page
3.4.1 Vertical Trend display	36
3.4.2 Horizontal Trend display	38
3.4.3 Circular Trend	40
TREND MODES	40
NORMAL VIEW	41
NORMAL VIEW FEATURES	42
FULL SCREEN DISPLAY	42
TIMESTAMPS	43
OTHER NOTES	43
3.4.4 Vertical bargraph	44
FACEPLATES ABOVE THE BARS	44
FACEPLATES AT RIGHT-HAND EDGE	44
3.4.5 Horizontal bargraph	46
3.4.6 Numeric	48
3.5 OPERATOR NOTES	50
4 SETTING UP THE RECORDER	51
4.1 ARCHIVE	52
4.1.1 Local Archive	52
BRING ARCHIVE UP TO DATE	53
ARCHIVE ALL	53
ARCHIVING WITH THE LOCKABLE FLAP OPTION	53
4.1.2 Remote archiving	54
File Transfer Protocol	54
Secure File Transfer Protocol (SFTP)	54
4.2 SAVE / RESTORE	55
4.2.1 Save	56
SAVE AS	56
4.2.2 Restore	56
4.2.3 New	56
SFTP Key Pair - Generate	56
4.2.5 Import screen	57
4.2.6 Export screen	57
4.2.7 Import User Linearisation	57
4.2.8 Export User Linearisation	57
4.2.9 Import printer driver	57
4.2.10 Import Public Key	58
Secure FTP (SFTP) Public Key - Import	58
4.2.11 Export Public Key	61
SFTP Public Key - Export	61
4.3 CONFIG KEY	62
4.3.1 Instrument configuration	67
INSTRUMENT NAME	67
NORMAL/SAVER DISPLAY	67
SAVE AFTER	67
MODBUS ADDRESS	67
MODBUS SECURITY DISABLED	67
COMMS CHANNEL TIMEOUT	67
PRESET HOUR	68
PRESET MINUTE	68
DISABLE WARNING DIALOGS	68
SHOW OPERATOR NOTES LIST	68
4.3.2 Group configuration	69
GROUP NUMBER	70
TREND UNITS	70
DESCRIPTOR	70
TREND TYPE	70
A/B SWITCHING	71
TREND SPEED/TREND INTERVAL	71
CIRCULAR SETTINGS	71
CIRCULAR SPEED	71
CIRCULAR CHART FULL	71
START AT	71
CIRCULAR extended backfill	72
GRID TYPE	72

LIST OF CONTENTS (CONT.)

Section	Page
NONE	72
LINEAR	72
LOG	72
FROM POINT	72
RECORDING ENABLE	73
RECORDING SPEED/RECORDING INTERVAL	73
TREND HISTORY DURATION	73
ARCHIVE TO MEDIA ENABLE/ARCHIVE VIA FTP/(S)FTP ENABLE	73
ALARM MESSAGE	74
ACK MESSAGE	74
ALARM ACKNOWLEDGE	74
POINT TYPE/SELECTION	74
4.3.3 Channel/Alarm configuration	75
CHANNEL NUMBER	76
VALUE	76
INPUT TYPE	76
LIN TYPE	76
INPUT LOW	77
INPUT HIGH	77
SHUNT	77
RANGE LOW	77
RANGE HIGH	77
RANGE UNITS	77
SCALED	77
OFFSET	77
SCALE TYPE	78
FILTER	80
BREAK RESPONSE	80
COLD JUNCTION COMPENSATION (CJC)	80
DESCRIPTOR	80
A/B SWITCHING	80
SPANNED	81
ZONE	81
PV FORMAT	81
MAXIMUM DECIMAL DIGITS	81
COLOUR	81
ALARM NUMBER	81
ENABLE	82
TYPE	82
SETPOINT SOURCE	82
PARAMETERS	83
HYSTERESIS EXAMPLE	83
RATE-OF CHANGE ALARM EXAMPLE	83
JOB NUMBER	85
CATEGORY	85
WHILE/ON	85
ALARM MESSAGES	85
4.3.4 Views Configuration	86
Group Cycling Interval	86
HOME TIMEOUT	86
HOME GROUP	86
SCOPE	87
GROUP	87
DISPLAY ENABLE	87
HOME PAGE	87
DISPLAY MODE ENABLING	87
4.3.5 Archive configuration	89
COMPRESSION	90
FLASH SIZE	90
SHORTEST TREND HISTORY / DURATION	90
CSV CHECK BOXES, DATE/TIME FORMAT	90
SHOW	90
MEDIA	90
ARCHIVE TO MEDIA	91
MEDIA FILE FORMAT/FTP/(S)FTP FILE FORMAT	91
ON MEDIA FULL	91
MEDIA SIZE	91

LIST OF CONTENTS (CONT.)

Section	Page
4.3.5 ARCHIVE CONFIGURATION (CONTINUED)	
REMOVABLE MEDIA CAPACITY	91
MEDIA FULL EVENT LIMIT	91
ARCHIVE TO REMOTE	92
REMOTE PATH	92
PRIMARY REMOTE HOST	92
PRIMARY LOGIN NAME/PASSWORD	92
SECONDARY REMOTE HOST/LOGIN/PASSWORD	92
CSV FILES	93
MEDIA FILE FORMAT	93
CSV DATE/TIME FORMAT	94
FTP(S)FTP FILE FORMAT	94
4.3.6 Event configuration	95
OPERATOR	97
SOURCE 2 SENSE	97
DESCRIPTOR	97
JOB NUMBER	97
CATEGORY	97
WHILE/ON	97
EVENT EXAMPLE	97
4.3.7 Event Buttons	98
4.3.8 Messages	99
MESSAGE ENTRY	99
4.3.9 User Linearisation Tables	102
CONFIGURATION PARAMETERS	102
4.3.10 Batch recording option	104
AUDITOR MESSAGES	104
BATCH SUMMARY	104
THERMAL UNIFORMITY SURVEY (TUS)	104
CONFIGURATION	105
OPERATOR INITIATION	108
NON OPERATOR INITIATION	111
EVENT SOURCES	111
4.3.11 Maths	112
CONFIGURATION	112
REMAINING CONFIGURATION ITEMS	116
FUNCTION DETAILS	116
MODBUS ADDRESSING	139
4.3.12 Totalisers	142
INTRODUCTION	142
4.3.13 Counters	147
INTRODUCTION	147
CONFIGURATION	147
CONFIGURABLE PARAMETERS	147
COUNTER MODBUS ADDRESSING	148
4.3.14 Timers	151
INTRODUCTION	151
CONFIGURATION	151
Configurable parameters	152
SELF-START EXAMPLE	152
4.3.15 Connections	153
INTRODUCTION	153
INSTALLATION	153
CONFIGURATION	154
CONFIGURATION PARAMETERS	155
MODBUS ADDRESS	157
4.3.16 Master comms	158
INTRODUCTION	158
MASTER COMMS CONFIGURATION MENU	159
CONFIGURABLE PARAMETERS	159
DETECT THIS SLAVE	160
DETECT ALL SLAVES	161
SHARE SOCKET	163
MASTER COMMS CHANNEL CONFIGURATION	164
READING DIGITAL VALUES	170
MASTER COMMS DIAGNOSTICS	176

LIST OF CONTENTS (CONT.)

Section	Page
4.3.17 Output channels	177
MASTER COMMS	177
ANALOGUE OUTPUTS (RETRANSMISSION)	178
4.3.18 Demand Writes	179
DEMAND WRITE CONFIGURATION	179
WRITING TO A SPECIFIC REGISTER	181
DEMAND WRITES WITH AUDIT TRAIL	182
4.3.19 E-mails	183
E-MAIL CONFIGURATION	183
CONFIGURABLE PARAMETERS	184
E-MAIL DETAILS	185
OPERATION	186
4.3.20 Reports configuration	187
4.3.21 Ethernet/IP™ Option	189
MESSAGING	189
CONFIGURATION	190
TABLE ENTRY	191
CONFIGURING A PLC	195
4.3.22 Options	201
TRIAL MODE	202
VIRTUAL CHANNELS	202
SIMULATION OPTION	203
4.4 SECURITY	204
4.4.1 Access levels	205
SETTING PERMISSIONS	205
ACCESS WHEN	206
DOMAIN NAME	206
NEW PASSWORD/RETYPE PASSWORD	206
CONNECT FROM REMOTE	206
REMOTE USER NAME/REMOTE PASSWORD	206
LOGIN DISABLED	207
EDIT OWN PASSWORD	207
CHANGE ALARM SETPOINTS	207
ACKNOWLEDGE ALARMS	207
EDIT MATHS CONSTANT	207
RESET MATHS	207
PRESET TOTALISERS	207
PRESET COUNTERS	207
START/RESET TIMERS	207
SET CLOCK	207
ADJUST I/O	207
ARCHIVING CONTROL	208
SAVE/RESTORE	208
PASTE/DELETE FILES	208
FULL CONFIGURATION	208
FULL SECURITY	208
BATCH CONTROL	208
CAN SIGN	208
CAN AUTHORIZE	208
PERFORM UPGRADES	208
EVENT PERMISSION 1	208
EVENT PERMISSION 2 TO 5	208
EDIT OUTPUT CHANNEL DEFAULT	208
ACTION DEMAND WRITES	209
FORCE CHANGE OF PASSWORD	209
ENTER BATCH DATA	209
ALLOW WEB SERVER	209
4.4.2 Management (option)	210
CHANGES NOT RECORDED	210
CONFIGURABLE PARAMETERS	210
4.4.3 Add user	215
NEW USER ID	215
NEW FULL USER NAME	215
NEW DOMAIN NAME	215
NEW PASSWORD/RETYPE PASSWORD	215
BASED ON	215

LIST OF CONTENTS (CONT.)

Section	Page
4.4.4 Remove user	216
4.4.5 Change Password	216
TROUBLE SHOOTING	216
4.4.6 Clear Password Cache	217
USER PASSWORD AUTHENTICATION	217
PASSWORD CACHE	217
CLEAR PASSWORD CACHE	217
4.4.7 Active Directory server setup	217
4.5 NETWORK KEY	220
4.5.1 Address	220
INSTRUMENT NUMBER/MAC ADDRESS	220
IP ADDRESS LOOKUP	220
BOOTP TIMEOUT	220
IP ADDRESS	221
SUBNET MASK	221
DEFAULT GATEWAY	221
SFTP ENABLE	221
SNTP SERVER ENABLE	221
SNTP CLIENT ENABLE	221
SNTP SERVER	221
SNTP TIMEOUT	222
EUROPRP SERVER ENABLE	222
Web server enable	222
ACTIVE DIRECTORY SERVER	222
ACTIVE DIRECTORY SECURITY	222
PASSWORD CACHE EXPIRY	222
4.5.2 Name	223
LOCAL HOST	223
DOMAIN	223
DOMAIN NAME SERVICE (DNS)	223
PRIMARY/SECONDARY DNS SERVER	223
4.6 SYSTEM	224
4.6.1 Clock	226
4.6.2 Locale	226
LONG DATE FORMAT	226
4.6.3 Upgrade	227
4.6.4 Input adjust	228
4.6.5 Output Adjust	230
4.6.6 Master Comms Diagnostics	230
4.6.7 Ethernet Diagnostics	230
4.6.8 Copy	231
CONFIGURABLE PARAMETERS	232
COPY RULES	232
4.6.9 Job search	233
SEARCH RESULTS	233
4.6.10 Customise	234
FONT SIZE EXAMPLES	235
4.6.11 About	236
INSTRUMENT VARIANT	236
CONFIG REVISION	236
LAST UPDATED	236
AT VERSION	236
CREATED ON	236
SECURITY REVISION	237
SUPPORT FILE	237
4.7 JOBS	238
4.7.1 No Action	238
4.7.2 Drive relay category	238
4.7.3 Totaliser category	238
4.7.4 Message category	239
4.7.5 Maths category	239
4.7.6 Clock category	240

LIST OF CONTENTS (CONT.)

Section	Page
4.7.7 Counter category	240
4.7.8 Timer category.....	241
4.7.9 Batch category	241
4.7.10 Recording category	242
4.7.11 Trend category	243
4.7.12 Output category	244
4.7.13 Demand Writes category.....	244
4.7.14 Alarm category	245
4.7.15 Archive category	245
4.7.16 Email category	246
4.7.17 Report category.....	246
SEND REPORT TO	246
GROUP	246
REPORT	246
4.8 SECURE FILE TRANSFER PROTOCOL (SFTP)	247
4.8.1 Overview	247
OPERATION	247
CONFIGURATION	248
4.8.2 SFTP Commissioning Tasks	251
SFTP ENABLE	251
SFTP Key Pair - Generate	251
Export Public key	251
Import Public key	252
5 FILE.....	253
5.1 FILER OPTION MENU KEYS	253
5.2 THE HIDE KEY	253
5.3 FILE STRUCTURE	255
6 BRIDGE (REMOTE VIEWER).....	256
6.1 INTRODUCTION	256
6.1.1 Minimum PC requirements	257
SUPPORTED PDA CONFIGURATION	257
6.1.2 Software Installation Requirements.....	257
6.2 CONNECTION DETAILS	258
6.2.1 Direct PC connection	258
6.2.2 PC To remote recorder	258
6.2.3 Networked systems	258
6.3 SOFTWARE INSTALLATION.....	259
6.4 RECORDER CONFIGURATION	259
6.4.1 Network.....	259
6.4.2 Options.....	259
6.4.3 Access.....	260
Bridge SFTP configuration.....	262
CHANNEL ALARM SOUND	263
6.6 OPERATION.....	264
6.6.1 Display Modes	264
6.6.2 Alarm acknowledgement	264
6.6.3 Status line	264
6.6.4 Error messages	264
NETWORK CONNECTION HAS TIMED OUT	264
UNABLE TO CONNECT TO HOST	264
UNABLE TO RESOLVE HOSTNAME.....	264
FAILED TO AUTHENTICATE THE USER NAME	264
MAXIMUM NUMBER OF BRIDGE SESSIONS ALREADY RUNNING ON	264
THERE APPEARS TO BE NO FREE DISK SPACE ON	264
YOU ARE ALREADY RUNNING A FULL BRIDGE SESSION	264
YOU ARE AUTHENTICATING FULL BRIDGE	264
7 SCREEN BUILDER.....	265
7.1 INTRODUCTION	265
7.1.1 Display Access	266
7.1.2 Importing/Exporting screens	266
IMPORTING SCREENS	267
EXPORTING SCREENS	267

LIST OF CONTENTS (CONT.)

Section	Page
7.2 DISPLAY CREATION	267
7.2.1 Before starting	267
7.2.2 Screen components	268
7.2.3 The properties page	269
KEY DESCRIPTIONS (UPPER KEYS)	269
OPTIONS PAGE ITEMS	271
7.2.4 Screen creation example	272
PROCEDURE	272
7.3 PARAMETER DEFINITIONS	276
7.3.1 Basic parameters	276
7.3.2 Advanced parameters	278
7.4 COMPONENT DEFINITIONS	284
7.4.1 Group Vertical/Horizontal Trend	284
7.4.2 Group vertical bargraph	284
7.4.3 Group horizontal bargraph	284
7.4.4 Group numeric display	285
7.4.5 Channel vertical/horizontal bargraph	285
7.4.6 Channel Numeric	285
7.4.7 Channel data	285
7.4.8 Dialogue Action	285
7.4.9 Navigation Action	285
7.4.10 Operator button	286
7.4.11 Event Button	286
7.4.12 Image	286
7.4.13 Text	287
7.4.14 Round rectangle	287
7.4.15 Rectangle	287
7.4.16 Polyline- series of points	288
7.4.17 Polygon - closed area	289
7.4.18 Oval	290
7.4.19 Line	290
EXAMPLE	290
7.4.20 Arc	291
EXAMPLE	291
7.5 MEASURING UNIT COMPARISONS	292
7.5.1 XGA screen	292
7.5.2 QVGA screen	292
7.6 ERROR CODES	292
8 MODBUS TCP SLAVE COMMS	293
8.1 INSTALLATION	293
8.2 INTRODUCTION	293
8.2.1 Function Codes	293
DIAGNOSTIC CODES	293
EXCEPTION CODES	294
8.2.2 Data types	294
DATA ENCODING	294
8.2.3 Invalid multiple register writes	294
8.2.4 Security	294
TO SEND A LOGIN REQUEST	297
8.2.5 Text messages	299
LONG MESSAGES	299
8.3 ADDRESS MAP	301
8.4 ADDRESS ALLOCATION	303
8.4.1 Instrument data	303
8.4.2 Channel configuration data	304
CHANNEL 1	304
CHANNEL 2	305
CHANNEL 3	306
CHANNEL 4	307

LIST OF CONTENTS (CONT.)

Section	Page
CHANNEL 5	308
CHANNEL 6	309
CHANNEL 7	310
CHANNEL 8	311
CHANNEL 9	312
CHANNEL 10	313
CHANNEL 11	314
CHANNEL 12	315
8.4.3 Channel Run-Time data	316
CHANNEL 1	316
CHANNEL 2	316
CHANNEL 3	317
CHANNEL 4	317
CHANNEL 5	318
CHANNEL 6	318
CHANNEL 7	319
CHANNEL 8	319
CHANNEL 9	320
CHANNEL 10	320
CHANNEL 11	321
CHANNEL 12	321
8.4.4 Group data	322
GROUP 1	322
GROUP 2	323
GROUP 3	324
GROUP 4	325
GROUP 5	326
GROUP 6	327
8.4.5 Feature identification table (FIT)	328
8.4.6 Indirection tables	328
8.4.7 IEEE 32-bit channel configuration data	331
CHANNEL 1	331
CHANNEL 2	331
CHANNEL 3	331
CHANNEL 4	332
CHANNEL 5	332
CHANNEL 6	332
CHANNEL 7	333
CHANNEL 8	333
CHANNEL 9	333
CHANNEL 10	334
CHANNEL 11	334
CHANNEL 12	334
8.4.8 IEEE Area Channel run-time data	335
CHANNEL 1	335
CHANNEL 2	335
CHANNEL 3	336
CHANNEL 4	336
CHANNEL 5	337
CHANNEL 6	337
CHANNEL 7	338
CHANNEL 8	338
CHANNEL 9	339
CHANNEL 10	339
CHANNEL 11	340
CHANNEL 12	340
8.4.9 Permanent ID table	341
8.5 DATA TRANSMISSION	341
FUNCTION CODES AND EXCEPTION CODES	341
TEXT STRINGS	341
8.5.1 Function code 03	342
REQUEST	342
RESPONSE	342
EXCEPTION RESPONSES	342
8.5.2 Function code 04	343
8.5.3 Function code 06	343

LIST OF CONTENTS (CONT.)

Section	Page
REQUEST.....	343
RESPONSE	343
EXCEPTION RESPONSES.....	343
8.5.4 Function code 08	343
8.5.5 Function code 16 (Hex 10).....	344
REQUEST.....	344
RESPONSE	344
EXCEPTION RESPONSES.....	344
9 ANALOGUE OUTPUT OPTION	345
9.1 SIGNAL WIRING	345
9.2 SPECIFICATION	345
9.3 CONFIGURATION	345
9.4 OUTPUT ADJUST	345
9.4.1 Adjustment procedure.....	345
9.4.2 Adjustment removal.....	345
10 EVENT INPUT OPTION	347
10.1 INTRODUCTION.....	347
10.2 SIGNAL WIRING	347
10.3 SPECIFICATION	347
11 TRANSMITTER POWER SUPPLY	348
11.1 INTRODUCTION	348
11.2 FUSING.....	348
11.2.1 Fuse Rating.....	348
11.2.2 Access to the user connections/fuse	348
11.2.3 User wiring	350
12 ASCII PRINTER OUTPUT OPTION.....	351
12.1 INTRODUCTION.....	351
12.2 WIRING.....	351
12.2.1 Serial communications ports	351
12.2.2 DC connection	351
12.3 CONFIGURATION	352
12.3.1 Connections.....	352
PORT	352
LINK ERROR COUNT	352
PROTOCOL.....	353
BAUD RATE.....	353
STOP BITS.....	353
PARITY	353
PRINTER TYPE	353
PRINTER NAME	353
PRINTER STATUS	353
PRINTER TEST.....	353
PRINT MESSAGES FROM	353
MESSAGES TO PRINT	353
12.3.2 Reports configuration	354
REPORT	354
DESCRIPTOR	354
NUMBER OF FIELDS.....	354
FIELD N TYPE.....	354
STYLE.....	355
POINT.....	355
LINE FEED.....	355
12.3.3 ASCII Input Filtering.....	355
Text Filters.....	355
Configuration.....	355
12.4 IMPORTING PRINTER DRIVERS	358
12.5 REPORT EXAMPLE.....	359
12.5.1 Group Configuration	359
GROUP NUMBER 1	359
12.5.2 Channel configuration.....	359
CHANNEL 1	359
CHANNEL 2	359
CHANNEL 3	359

LIST OF CONTENTS (CONT.)

Section	Page
CHANNEL 4	359
12.5.3 Event Configuration	360
EVENT NUMBER 1	360
12.5.4 Report Configuration	360
12.5.5 Serial Communications Configuration	361
12.6 TSP600 SWITCH SETTINGS	362
13 PORTABLE CASE OPTIONS.	363
13.1 BASIC OPTION	364
13.1.1 Introduction	364
13.1.2 Wiring	364
SUPPLY VOLTAGE	364
SIGNAL WIRING	364
INTERNAL WIRING	364
13.2 TRANSMITTER POWER SUPPLY (TRS) OPTION	366
13.2.1 Internal wiring	366
13.3 HTM2010 QUARTERLY TEST KIT	368
13.3.1 Introduction	368
13.3.2 Wiring	368
SUPPLY VOLTAGE	368
SIGNAL WIRING	368
INTERNAL WIRING	369
13.3.3 Specification	369
13.4 THERMOCOUPLE OPTION	370
13.4.1 Introduction	370
13.4.2 Wiring	370
SUPPLY VOLTAGE	370
SIGNAL WIRING	370
THERMOCOUPLE WIRING	371
13.4.3 Specification	372
13.5 LOW SUPPLY VOLTAGE OPTION*	373
13.6 REMOTE CJC BLOCK OPTION	374
13.6.1 Introduction	374
13.6.2 Wiring	374
SIGNAL WIRING	374
13.6.3 Specification	375
14 REMOTE CJ BLOCK OPTION.	376
14.1 LARGE FRAME RECORDER WITH INTEGRAL CJC BLOCK	376
14.1.1 Introduction	376
14.1.2 Wiring	376
SIGNAL WIRING	376
14.1.3 Specification	378
14.2 LARGE FRAME RECORDER WITH REMOTE CJC BLOCK	379
14.2.1 Introduction	379
14.2.2 Signal wiring	379
SIGNAL WIRING	379
14.2.3 Specification	382
14.3 SMALL FRAME RECORDER	383
14.3.1 Introduction	383
14.3.2 Signal wiring	383
SIGNAL WIRING	383
14.3.3 Specification	385
15 THERMAL UNIFORMITY SURVEY (TUS) OPTION.	386
15.1 PRE CALIBRATION AND POST CALIBRATION ENABLE	386
Pre calibration	386
Post calibration	386
15.2 INPUT ADJUST	387
ADJUST PROCEDURE	388
15.3 CHART MESSAGES	389
15.4 OTHER ITEMS	389

LIST OF CONTENTS (CONT.)

Section	Page
ANNEX A: SPECIFICATION	390
INSTALLATION CATEGORY AND POLLUTION DEGREE	390
Installation category II	390
Pollution degree 2	390
TECHNICAL SPECIFICATION (RECORDER)	391
TECHNICAL SPECIFICATION (UNIVERSAL INPUT BOARD)	394
WORST CASE ERROR CALCULATION	396
PREVIOUS INSTRUMENTS	397
TECHNICAL SPECIFICATION (RELAY OUTPUT BOARD)	398
TECHNICAL SPECIFICATION (EVENT INPUT BOARD)	399
TECHNICAL SPECIFICATION (ANALOGUE OUTPUT BOARD)	399
TECHNICAL SPECIFICATION (ASCII PRINTER)	399
ANNEX B: REFERENCE	400
B1 DIAGNOSTICS DISPLAY	400
B1.1 MAIN DIAGNOSTIC DISPLAY	400
B1.2 SPECIAL MODES	401
B1.3 DISPLAY TEST	401
B1.4 TOUCH CALIBRATION	401
B1.4.1 Touch screen calibrate	402
B1.4.2 Touch screen verify	402
B1.4.3 Main menu	402
B1.5 SYSTEM SUMMARY	403
B1.6 DIAG SUMMARY	403
B1.6.1 MAC Address	403
B1.6.2 Software version number	403
B1.6.3 Serial 1/Serial 2	404
B1.6.4 Battery	404
B1.6.5 Lockable	404
B1.6.6 Option boards	404
RELAY OUTPUT BOARDS	404
EVENT INPUTS	404
B1.6.7 Input boards	404
B1.6.8 Main menu	405
B1.7 QUIT	405
B2 PREVENTIVE MAINTENANCE	405
B2.1 TOUCH SCREEN CLEANING	405
B2.2 MAINTENANCE SCHEDULE	406
B2.2.1 Battery replacement procedure	406
B2.3 FLAP RELEASE	408
B3 OPTION ENABLING	409
B4 COLOUR SELECTION	409
B5 TCP PORT NUMBERS	412
B6 ASCII CHARACTERS FOR SERIAL COMMS	413
B7 TIME ZONE INFORMATION	414
B8 HISTORY MAINTENANCE OPTION	415
B8.1 KEYCODE EXTRACTION	415
B8.2 ERASING HISTORY	415
B9 MENU STRUCTURE	416

LIST OF CONTENTS (CONT.)

Section	Page
ANNEX C: WEB SERVER DETAILS	430
C1 INTRODUCTION	430
C2 INTERNET LINKS	430
C3 ACCESS TABS	430
C3.1 INSTRUMENT	430
C3.1.1 Instrument alarms	430
C3.1.2 Global channel alarm	430
C3.2 TRENDS	431
C3.2.1 Horizontal trend	431
C3.2.2 Vertical trends	432
C3.2.3 Numeric display	432
C3.3 MESSAGE LOGS	432
C3.4 HISTORY	433
C3.5 ABOUT	433
INDEX	434

SAFETY NOTES

WARNING

Any interruption of the protective conductor inside or outside the apparatus, or disconnection of the protective earth terminal is likely to make the apparatus dangerous under some fault conditions. Intentional interruption is prohibited.

Note: in order to comply with the requirements of safety standard BS EN61010, the recorder shall have one of the following as a disconnecting device, fitted within easy reach of the operator, and labelled as the disconnecting device.







- a. A switch or circuit breaker which complies with the requirements of IEC947-1 and IEC947-3
- b. A separable coupler which can be disconnected without the use of a tool
- c. A separable plug, without a locking device, to mate with a socket outlet in the building.

1. Before any other connection is made, the protective earth terminal shall be connected to a protective conductor. The mains (supply voltage) wiring must be terminated within the connector in such a way that, should it slip in the cable clamp, the Earth wire would be the last wire to become disconnected.
2. In the case of portable equipment, the protective earth terminal must remain connected (even if the recorder is isolated from the mains supply), if any of the I/O circuits are connected to hazardous voltages*.
3. The mains supply fuse within the power supply is not replaceable. If it is suspected that the fuse is faulty, the manufacturer's local service centre should be contacted for advice.
4. Whenever it is likely that protection has been impaired, the unit shall be made inoperative, and secured against accidental operation. The manufacturer's nearest service centre should be contacted for advice.
5. Any adjustment, maintenance and repair of the opened apparatus under voltage, should be avoided as far as possible and, if inevitable, shall be carried out only by a skilled person who is aware of the hazard involved.
6. Where conductive pollution (e.g. condensation, carbon dust) is likely, adequate air conditioning/filtering/sealing etc. must be installed in the recorder enclosure.
7. Signal and supply voltage wiring should be kept separate from one another. Where this is impractical, shielded cables should be used for the signal wiring.
8. If the equipment is used in a manner not specified by the manufacturer, the protection provided by the equipment might be impaired.

* A full definition of 'Hazardous' voltages appears under 'Hazardous live' in BS EN61010. Briefly, under normal operating conditions, hazardous voltages are defined as being > 30V RMS (42.2V peak) or > 60V dc.

SYMBOLS USED ON THE RECORDER LABELLING

One or more of the symbols below may appear as a part of the recorder labelling.

	Refer to the manual for instructions
	Protective earth
	This recorder for ac supply only
	This recorder for dc supply only
	This recorder for either ac or dc supply
	Risk of electric shock

USER GUIDE

1 INTRODUCTION

This document describes the installation, operation and configuration of a paperless graphic recorder. The recorder comes in two versions, which differ in physical size, and in the number of I/O channels and options available, but otherwise are identical (i.e. the operation and configuration procedures are the same for both).

The standard recorder comes equipped for FTP/(S)FTP transfer and is also fitted with 'Bridge' (Remote viewing) software.

1.1 UNPACKING THE RECORDER

The recorder is despatched in a special pack, designed to give adequate protection during transit. Should the outer box show signs of damage, it should be opened immediately, and the recorder examined. If there is evidence of damage, the instrument should not be operated and the local representative contacted for instructions. After the recorder has been removed from its packing, the packing should be examined to ensure that all accessories and documentation have been removed. The packing should then be stored against future transport requirements.

2 INSTALLATION

2.1 MECHANICAL INSTALLATION

Figures [2.1a](#) and [2.1b](#) give installation details for the small and large frame cases respectively.

Note: It is recommended that the rear face of the panel be centre-punched at suitable positions to locate the tips of the case clamps. Otherwise, particularly on smooth surfaces, the clamps can 'wander' as they are tightened, leading to inefficient clamping and possible damage to the recorder mounting slots.

The unit is inserted through the panel aperture from the front of the panel. With the weight of the recorder supported, a panel clamp is inserted into each of the mounting slots (one each on the left- and right-hand sides). The jacking screws are then tightened sufficiently to clamp the recorder into position. **EXCESS FORCE SHOULD NOT BE USED IN TIGHTENING THESE SCREWS.**

2 INSTALLATION (Cont.)

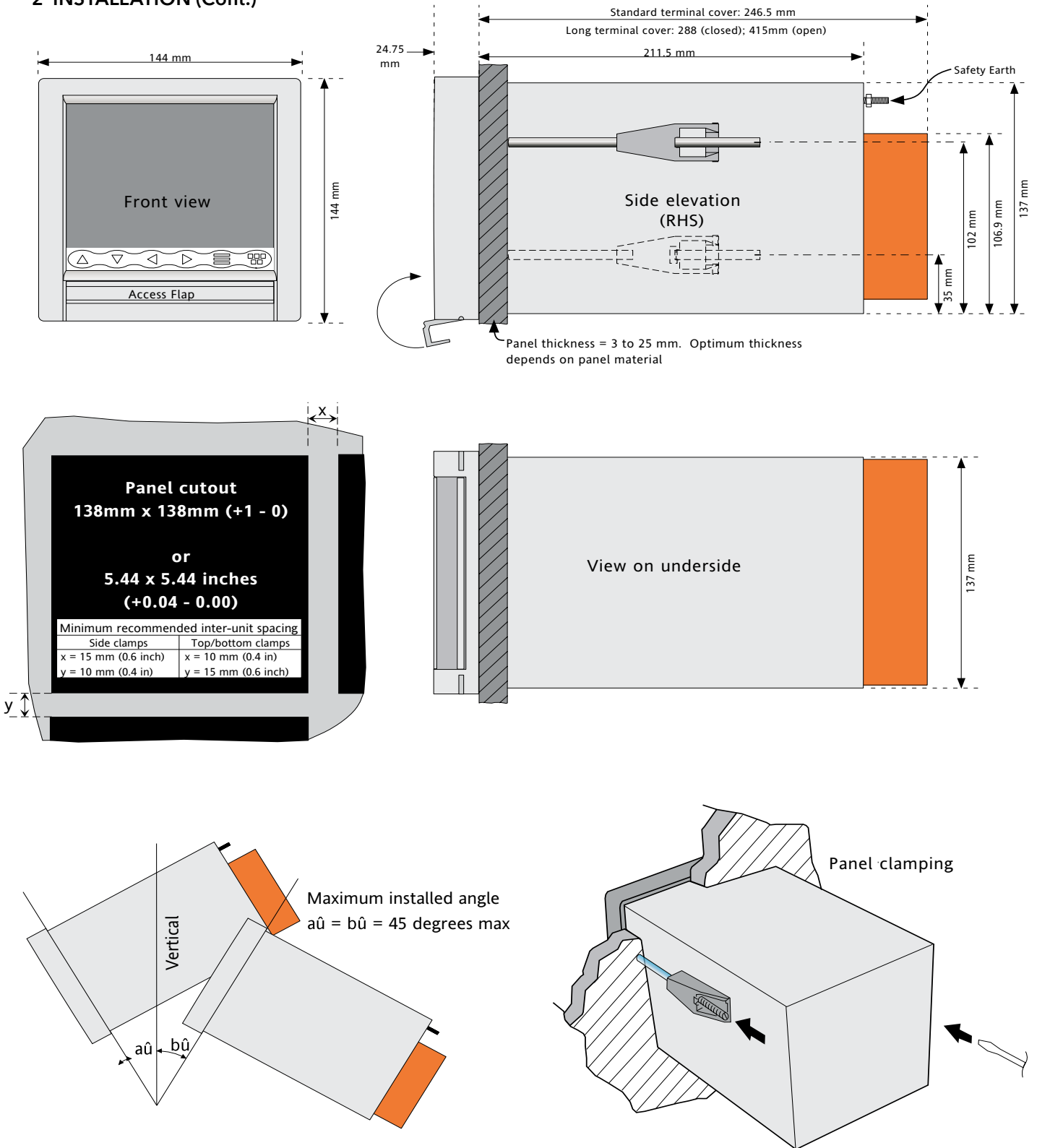

Figure 2.1a Mechanical installation details - small frame unit

2 INSTALLATION (Cont.)

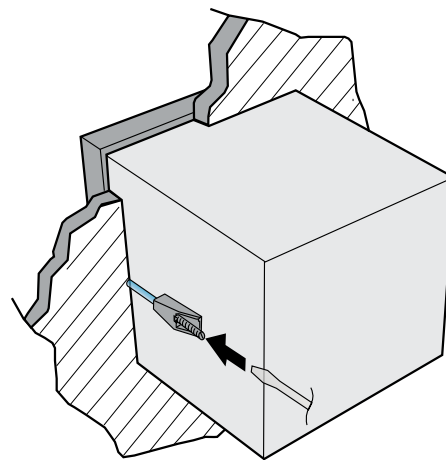
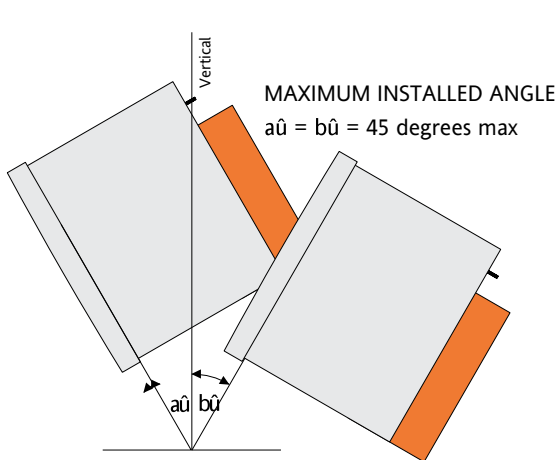
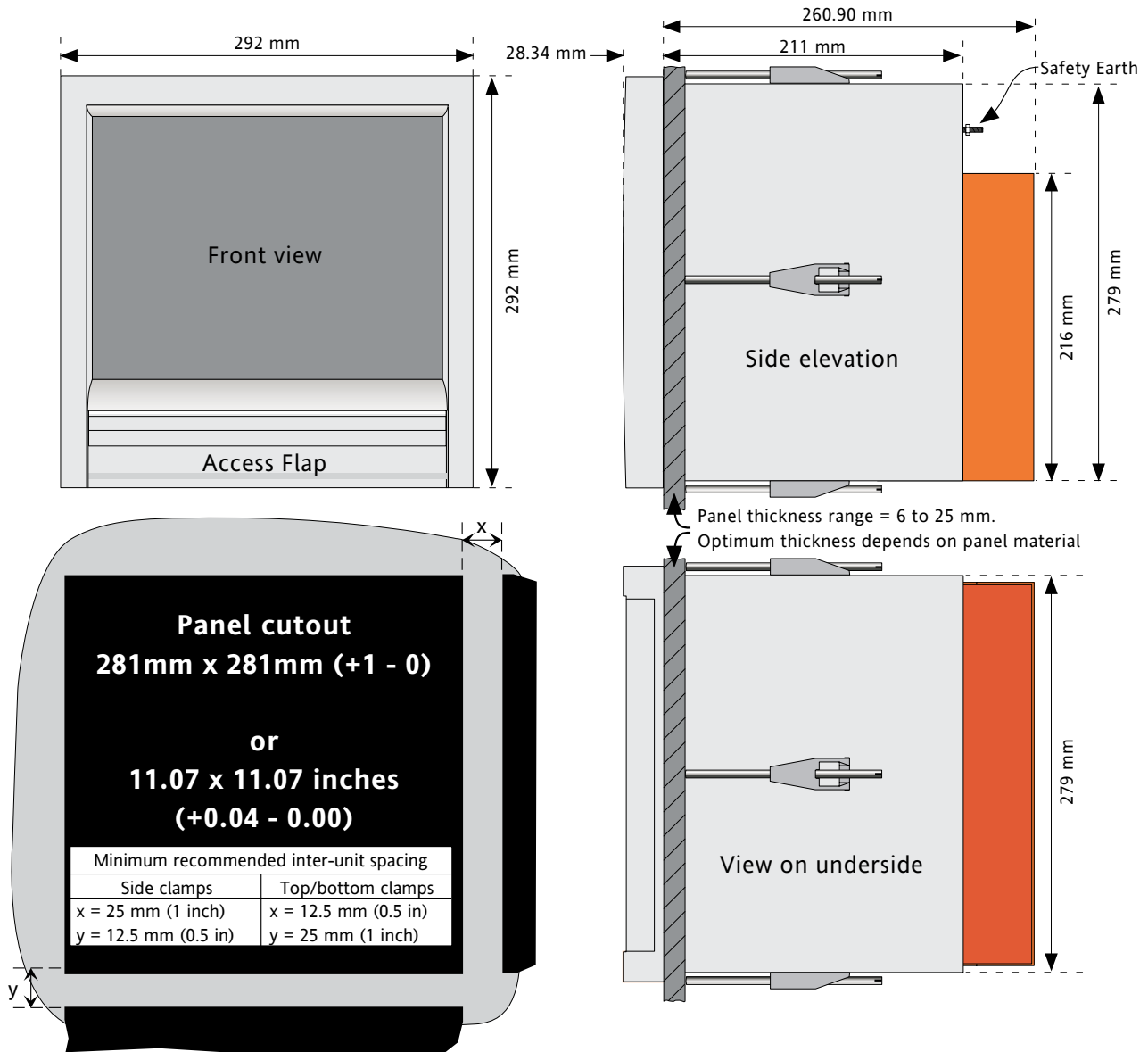

Figure 2.1b Mechanical installation details -large frame unit

2.2 ELECTRICAL INSTALLATION

2.2.1 Signal wiring

Figures 2.2.1a and 2.2.1b show connector locations for the small and large-frame recorders respectively. The figures are not to the same scale.

Figure 2.2.1c shows details of universal input board wiring and figure 2.2.1d gives the pinouts for option boards.

CONNECTOR WIRING DETAILS

Maximum wire size = 4.13mm² (11 AWG)
 Minimum wire size = 0.081mm² (28 AWG)
 Design torque = 0.35Nm.

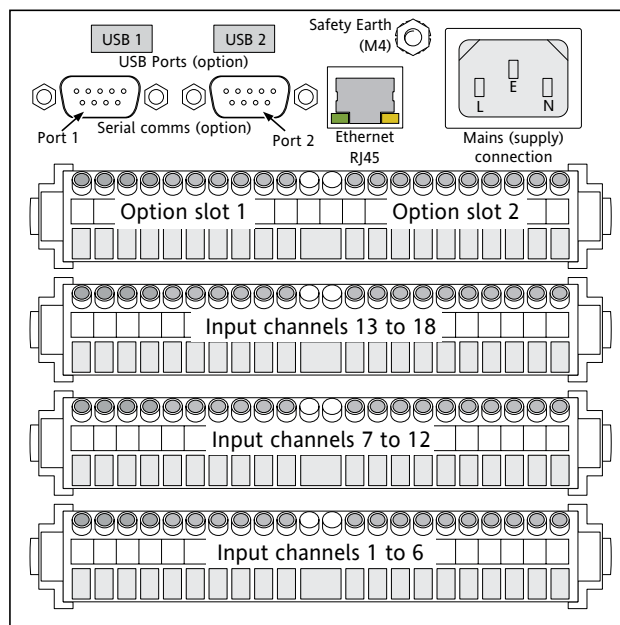
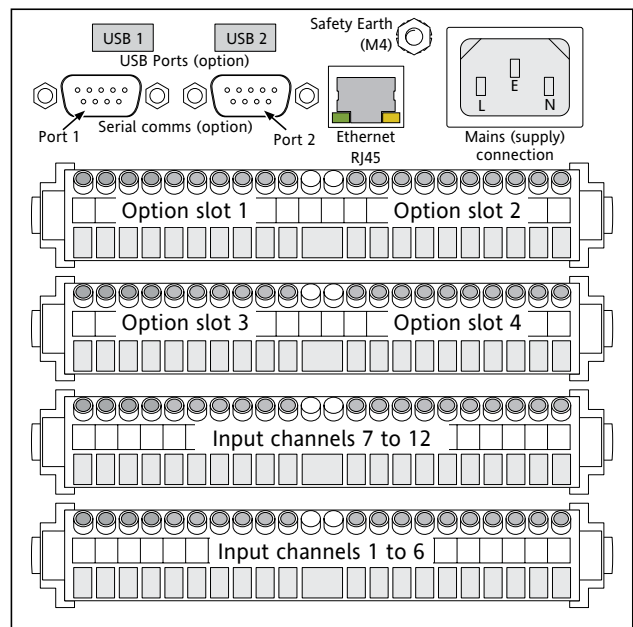
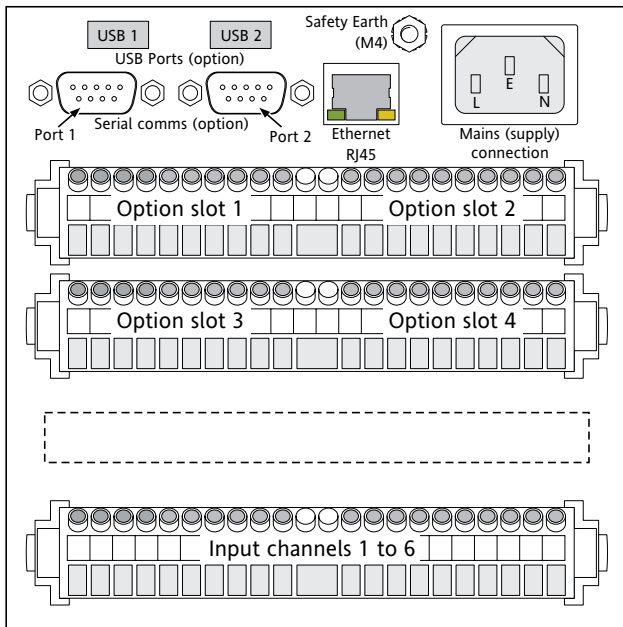

Figure 2.2.1a Connector locations - small frame units

2.2.1 SIGNAL WIRING (Cont.)

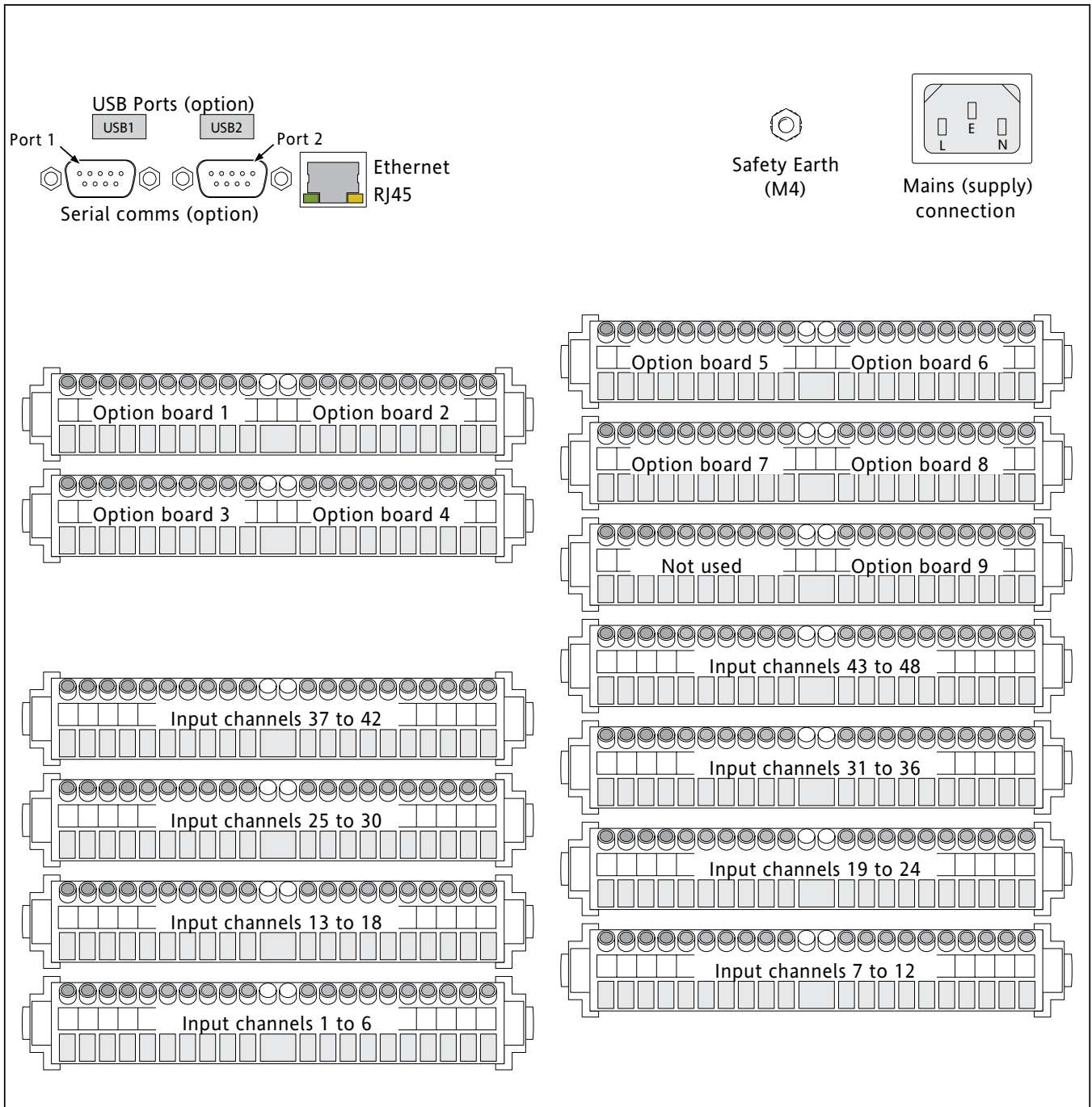

Figure 2.2.1b Connector locations - large frame units

2.2.1 SIGNAL WIRING (Cont.)

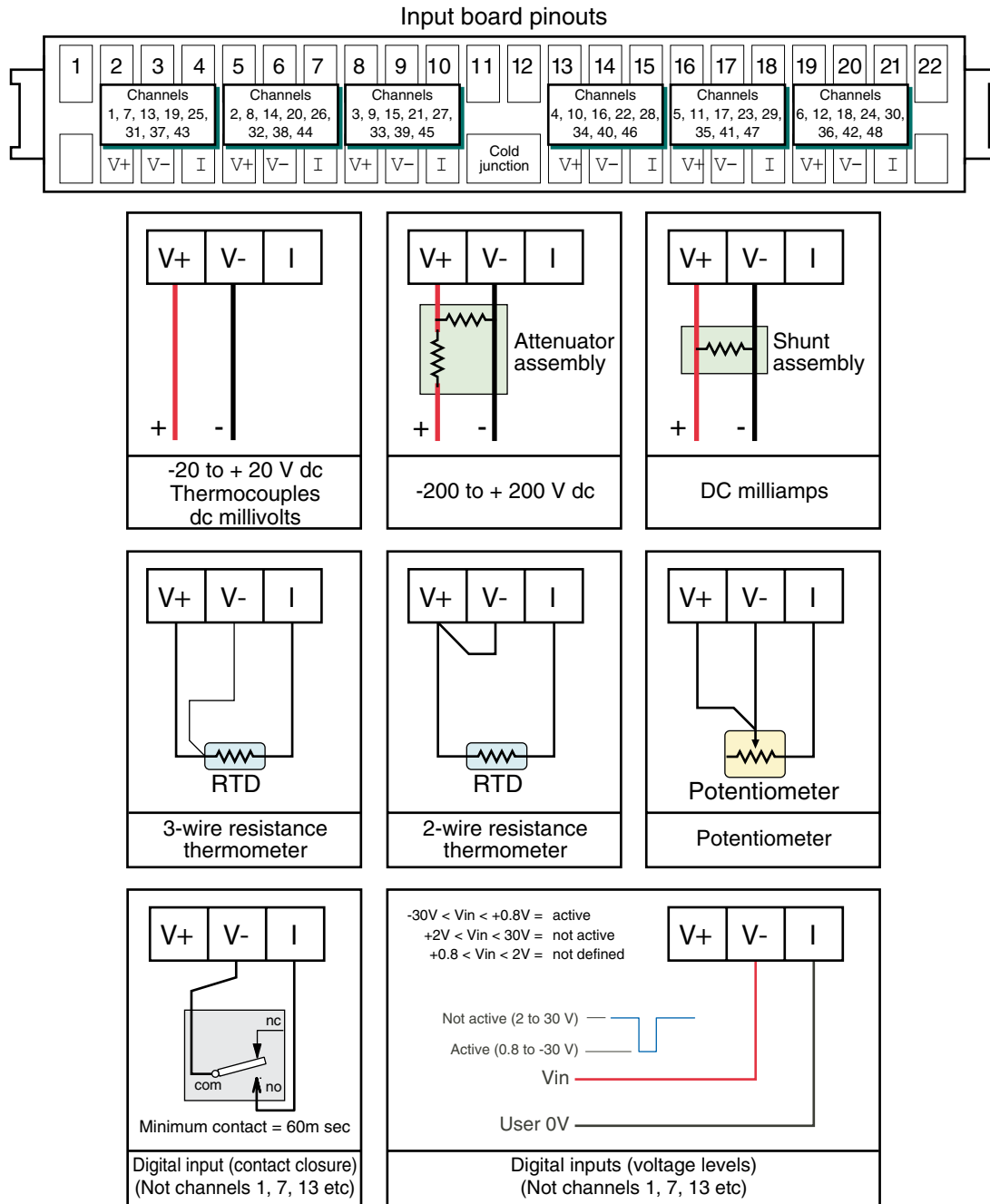

Figure 2.2.1c Analogue Input board wiring

2.2.1 SIGNAL WIRING (Cont.)

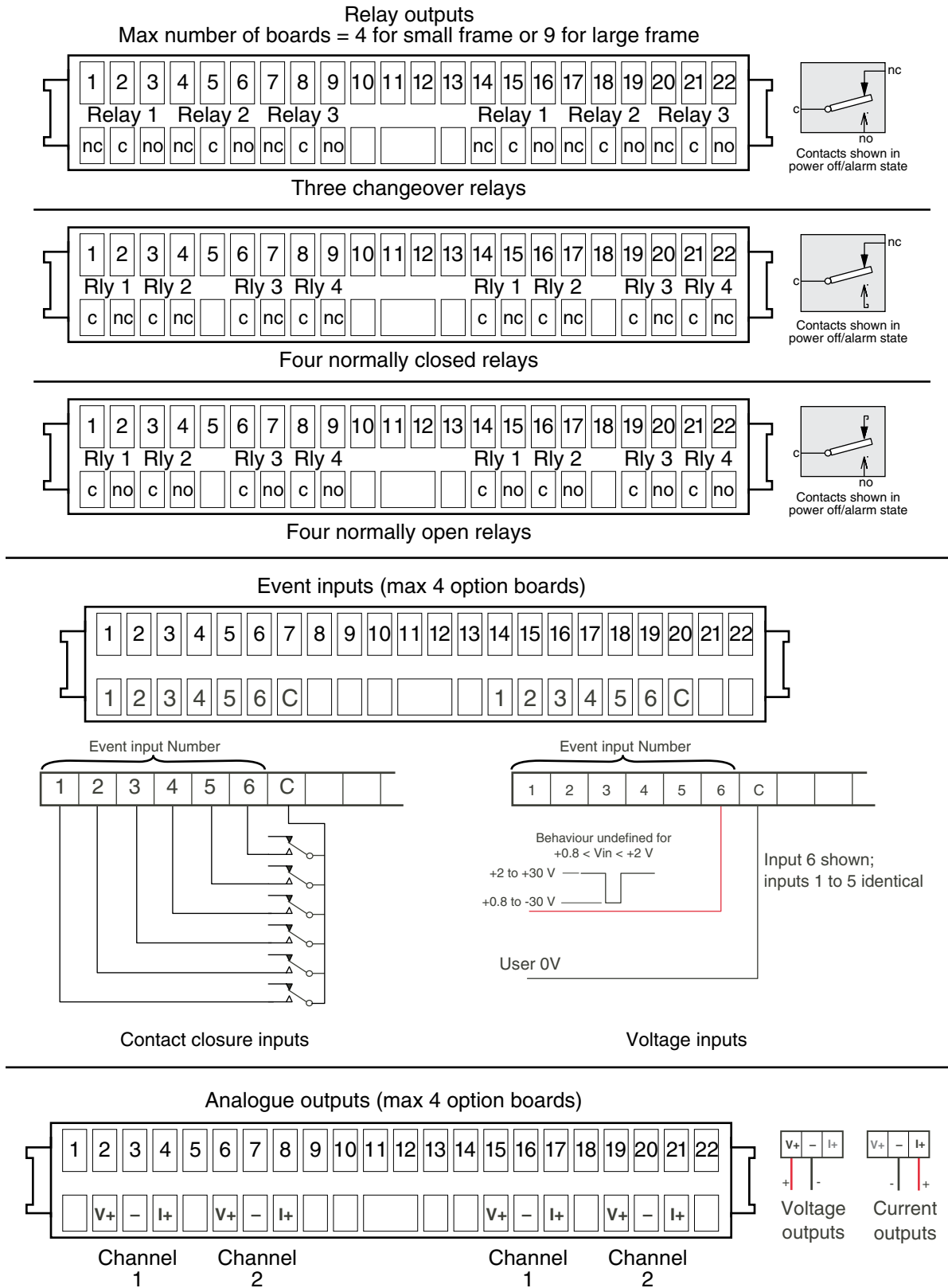
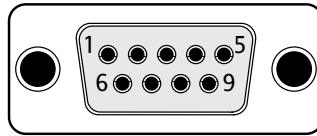

Figure 2.2.1d Option wiring sheet 1

2.2.1 SIGNAL WIRING (Cont.)



View on solder-bucket face
of user socket

EIA232C		EIA485 (5-wire)		EIA485 (3-wire)	
Pin	Signal	Pin	Signal	Pin	Signal
1	NC	1	RxA	1	Link to pin 7
2	Rx	2	NC	2	NC
3	Tx	3	NC	3	NC
4	DTR	4	NC	4	NC
5	Signal ground	5	Signal ground	5	Signal ground
6	NC	6	RxB	6	Link to pin 8
7	NC	7	TxA	7	TxA/RxA
8	NC	8	TxB	8	TxB/RxB
9	5V via 1500Ω	9	5V via 1500Ω	9	5V via 1500Ω

Figure 2.2.1d (Cont.) Option wiring sheet 2 (Serial communications)

2.2.2 Supply voltage wiring

Note: The minimum recommended wire size is 20AWG equivalent to 16/0.2 (0.5mm²).

LINE SUPPLY

The supply voltage to the recorder is terminated using an IEC socket which is connected to the mating plug at the rear of the recorder. The recorder is suitable for use with all ac voltages between 85 and 265 V RMS (47 to 63 Hz), and requires 50 W max. power.

LOW VOLTAGE SUPPLY OPTION¹

Not suitable for recorders fitted with the isolated transmitter power supply option.

The low voltage supply option is terminated at a three-pin connector (plug mounted on recorder - socket on supply cable) as shown in figure 2.2.2. The option allows the use of ac or dc supplies with the following characteristics:

AC: 20 to 42V RMS (45 to 400 Hz)

DC: 20 to 54V (See warning above)

Power: 50 W max.

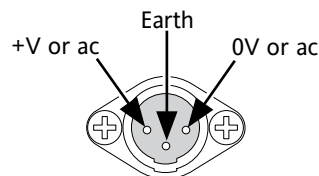
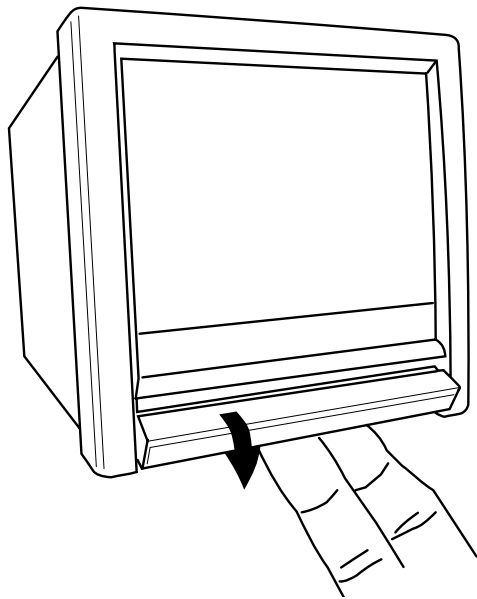

Figure 2.2.2 Low voltage supply pinout (view on fixed connector face)

¹⁾ Option obsolete.

2.3 ACCESS FLAP

Note: See also [section 2.4](#) if the lockable flap option is fitted. Lockable flaps are identified by means of a padlock symbol printed towards the right hand end of the flap label.



a) Insert finger(s) and pull forwards and down (small frame)

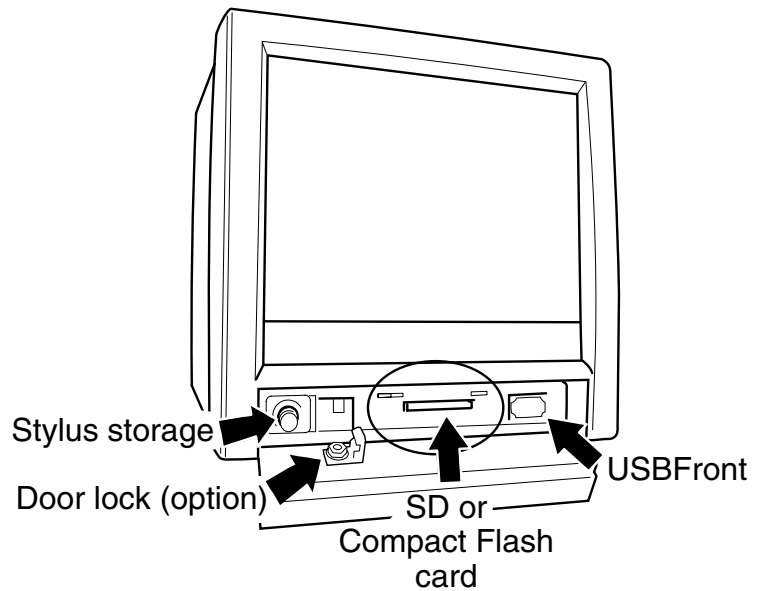

b) Behind flap details (small frame)

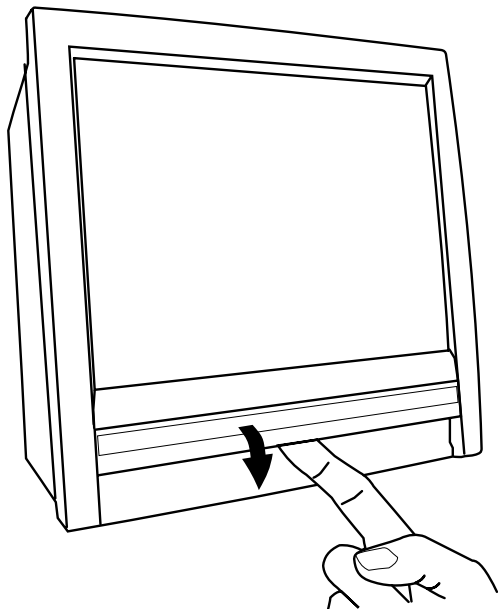

c) Insert finger(s) and pull forwards and down (large frame)

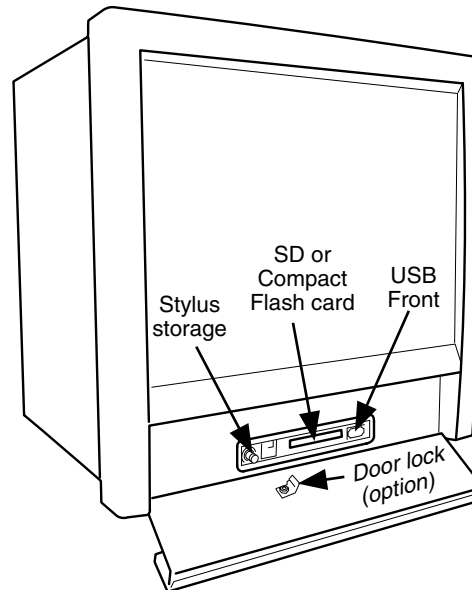

d) Behind flap details (large frame)

Figure 2.3 Access flap detail

The access flap is located immediately below the recorder screen. To open the flap, insert one or more fingers under the flap handle, and pull it outwards and down (figure 2.3). A lockable version of the flap is available - see [section 2.4](#) for details. Located behind the flap are (from left to right):

1. a stylus (press to eject)
2. a slot for a Compact Flash or Secure Digital (SD) card
3. a USB port (usbfront).

2.3.1 Stylus

A stylus suitable for use on the touch screen is located in a storage area to the left of the Compact Flash/SD Card slot.

2.3.2 Card slot

The slot for the Compact Flash or SD card is located centrally behind the flap. If an SD card is already fitted, it is removed by pressing on the card, to unlatch it, then pulling the card out of the slot. If a Compact Flash card is already fitted, it is removed by a double operation of the eject button. See details in figures 2.3.2a and 2.3.2b, below

CAUTION

Removal of the memory device whilst archiving is in progress causes irreparable damage to the filing structure on the device, rendering it unusable. For this reason, archiving should be suspended (section 4.1) (wait for the green section of the disk icon (section 3.1.3) to go 'white') before the device is removed. It is strongly recommended that the 'Remove Media' facility described in section 3.1.4 (Summary menu) be used to ensure that it is safe to remove the memory device. For recorders fitted with a lockable flap, see also section 2.4.

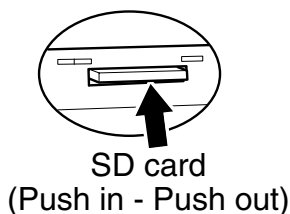

Figure 2.3.2a SD card details

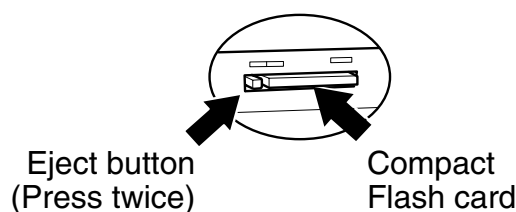

Figure 2.3.2b Compact Flash card details

LED INDICATORS

Three LED indicators are located above the card slot as shown in figure 2.3.2c, below.

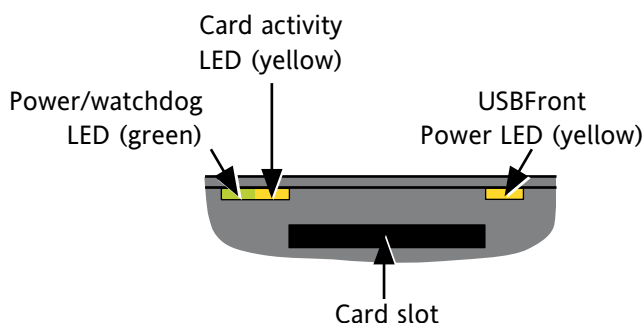

Figure 2.3.2c indicating LEDs (SD card - Compact Flash card similar)

2.3.3 USB Front Port

A type-A USB socket is located to the right of the Compact Flash/SD Card slot. This port can be used to connect a mouse, a keyboard, a barcode scanner, a 'memory stick' or a floppy disk drive. If more than one such device is required at a time, two further, rear panel USB ports (USB 1 and USB 2) are available as an option. Maximum current per USB device = 500 mA.

Note: It is the responsibility of the user to establish the electromagnetic susceptibility of any USB peripheral connected to the recorder. Refer to the USB port specification in Annex A for details.

2.4 LOCKABLE FLAP OPTION

This option allows the access flap below the display screen to be locked against unauthorized access to the Compact Flash/SD card. It also provides some protection (in the form of a warning message) against the inadvertent removal of such a card whilst archive data is being written to it. Removal of the memory device whilst it is being written to will not only corrupt the current archive, but might also damage the memory device irreparably, rendering it unusable. See also [section 3.1.4](#).

Notes:

1. Control of the flap lock is available only to users with 'Archiving Control' permission enabled.
2. Control of the flap lock is not possible via Bridge software.
3. The description below applies only to Archive data.

2.4.1 Flap lock operation

ARCHIVE INACTIVE

1. Touch the root menu or alarm status area at the top of the screen.
2. Touch the 'Unlock Flap' key (figure 2.4.1a).
3. Archiving is suspended, the internal solenoid releases the catch, to allow the flap to be opened, and a pop-up message appears 'OK to remove archive media' (figure 2.4.1b).
4. After approximately five seconds, the solenoid returns the catch to the locked position. The flap can be returned to the closed position whether or not the flap lock is engaged. It is up to the user to ensure that the flap is properly closed and locked.

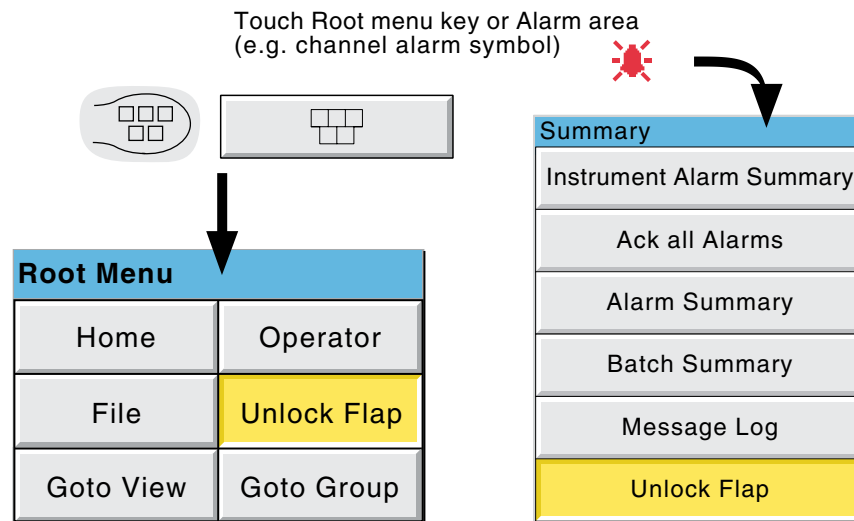

Figure 2.4.1a Unlock Flap key locations



Figure 2.4.1b 'OK to remove archive media' message

2.4.1 FLAP LOCK OPERATION (Cont.)

ARCHIVE ACTIVE

1. Touch the root menu key or alarm status area at the top of the screen.
2. Touch the 'Unlock Flap' key (figure 2.4.1a).
3. The flap unlocks for 5 seconds in the normal way (to allow access to the stylus and the usbfront port), but a warning message appears on the screen (figure 2.4.1c).
 - a) If the 'Cancel' key is operated, the message disappears. Subsequently, if this is a Demand Archive the 'Demand archive finished' message appears when the archive is complete. Archiving is not suspended, so operate the 'Suspend Archiving' key before removing the memory device. This ensures that no attempt will be made by the recorder to write to the device until 'Resume Archiving' is operated.
 - b) If the 'Cancel' key is not operated (the warning message remains on the screen), then when the archive is complete, archiving is automatically suspended and the flap unlocks again for five seconds, allowing the memory device to be removed. The message on the screen changes to 'OK to remove archive media' (figure 2.4.1b), although, for demand archives this is masked by the 'Demand archive finished' message.



Figure 2.4.1c 'Do Not Remove Archive Media' message

4. Archiving automatically resumes:
 - a. 15 seconds (max.) after a memory device is inserted.
 - b. after 10 minutes if no new memory device is inserted (i.e. the flap was opened for a reason other than to replace the memory device).

Note A System message is generated each time the flap is unlocked.

3 PROCESS VARIABLE DISPLAY

The operator interface consists of a touch-sensitive screen, showing either process variable values in one of a number of formats, or, showing configuration or operational details for use in setting up the recorder. This section (3) describes the process variable displays. [Section 4](#) describes the Configuration displays.

Figure 3, below, depicts a typical trend display for a large-frame unit and gives details of the various areas of the display page. The small frame display is similar, but the navigation keys are printed on a strip below the chart area instead of being drawn on the screen.

Notes:

1. Dialogue boxes, message boxes etc. cause Process Variable displays to 'freeze' for as long as the box is on display. Root and Option menus (amongst others) time-out (i.e. are removed from the display) after approximately one minute. Messages, however, are displayed until the operator takes action to remove them. It should be noted, especially, that several message boxes may be active at one time, but only the oldest one is visible, until it is removed to reveal the 'next oldest' message, and so on.
2. Many of the screen components can be customised as to colour/size etc. as described in [section 4.6.10 \(Customise\)](#).

TRUNCATION OF NUMERIC VALUES

If the amount of space on the display page is insufficient to display the full width of the process variable or scale value, then the displayed value is rounded down and the number of decimal places reduced. If the width is still too restricted, the value is displayed in 'scientific' format, or if this is still too wide, the final visible character of the integer part of the value is replaced by a '?' (as depicted in [figure 3.4.4b](#))

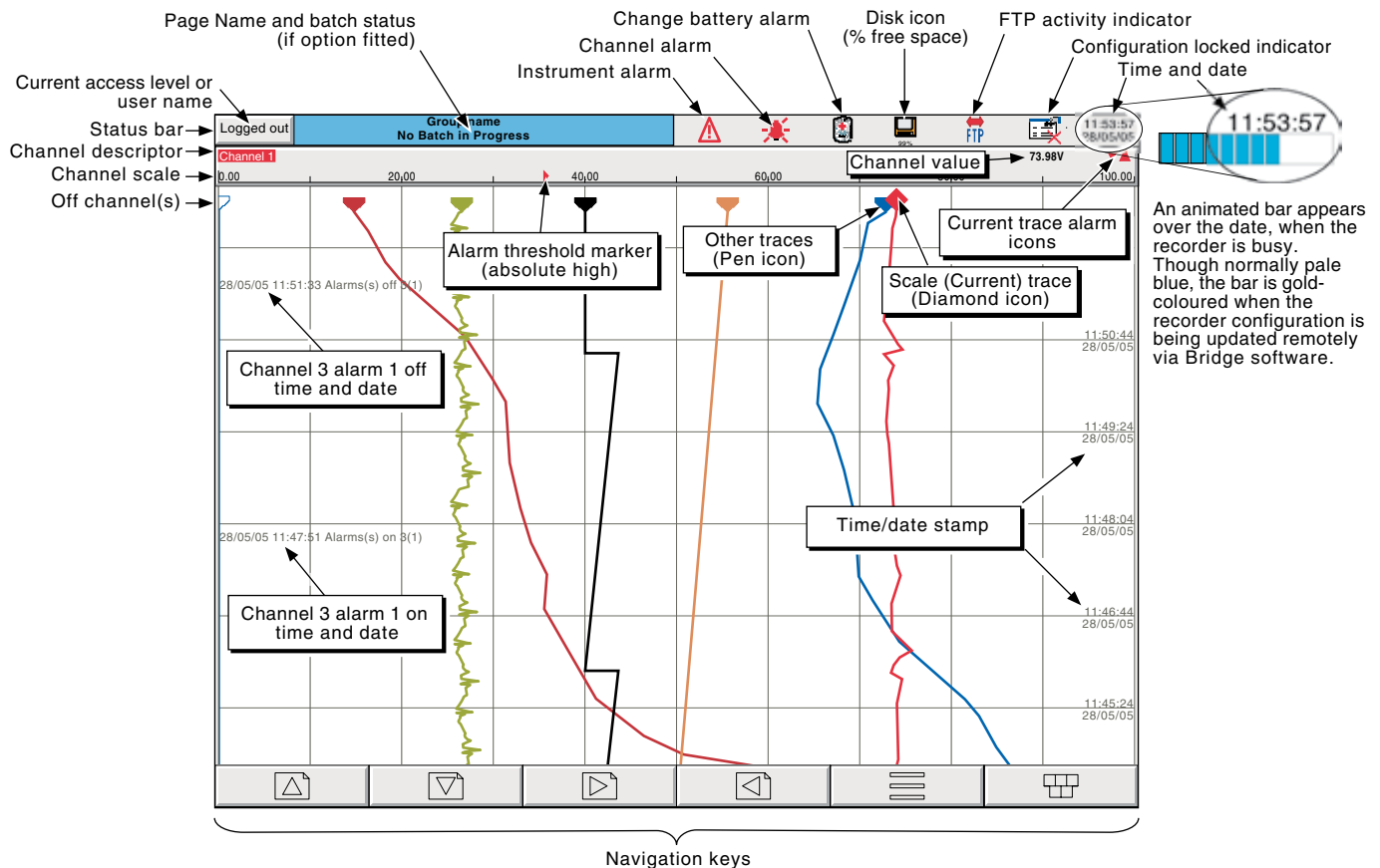







3 PROCESS VARIABLE DISPLAY (Cont.)







CURRENT TRACE ALARM ICONS

In each of the different types of PV display, each channel's faceplate gives the status of the channel's alarms. The status of each alarm is shown by one of the icons depicted in [table 3](#), either flashing (if it is active and unacknowledged) or on continuously (if it is active and acknowledged). (See [section 3.1.4](#), below, for a description of how to acknowledge alarms.) Absolute alarm threshold icons and deviation alarm bars appear in any display which includes a scale (except circular charts). For deviation alarms the bar stretches from (Reference - Deviation) to (Reference + Deviation).

Note: 'Trigger' alarms do not display threshold marks or bars, or faceplate symbols.

	Absolute High
	Absolute Low
	Deviation in
	Deviation out
	Rate-of-change Rising
	Rate-of-change Falling

Faceplate symbols

	Absolute low	Absolute high	Deviation In / Out	Rate of change
Horizontal scales				No indication
Vertical scales				No indication

For Deviation alarms, R = Reference; d = deviation

Scale symbols

Table 3 Alarm icons

3.1 STATUS BAR

This appears across the top of the display, and contains the items described below.

3.1.1 Current access level

The following access levels are available (Logged out, Engineer and Operator). The current level is displayed in the key at the top left hand corner of the display. Touching this key calls the login page as described in [3.3.2 Access to Configuration on page 32](#).

If a user has been added (using the 'Add User' part of the Security setup ([Section 4.4.3 Add user on page 215](#)), then the 'Full User Name' is displayed instead of the access level.

3.1.2 Page name

Initially this shows the current group's descriptor. The name changes according to context for example 'Operator' or 'Config-Archive'. If the Batch option is fitted, this area contains batch information as well as the page name. Touching the area calls the Batch Status page. See [section 4.3.10](#) for further Batch details.

3.1.3 Alarm indication

This area of the display can contain a number of status icons: Instrument alarm, Channel alarm, Battery change, Disk status, FTP/(S)FTP in progress, Configuration locked, and so on. Pressing this area of the screen calls the 'Summary menu' (section 3.1.4) allowing the user to view active instrument alarms, to acknowledge all channel alarms, to display the Alarm Summary or Message Log page. Media removal strategy is also controlled from this pop-up. If the access flap 'Lock' option is fitted, see also [section 2.4](#).

For channel alarm symbols refer to '[Current Trace Alarm Icons](#)', above.

INSTRUMENT ALARM

This indicator appears, flashing, if any of the following errors are active. The instrument alarm summary page, described in Section 3.1.4, allows the user to view such instrument alarms as are active.

Active Directory server error	The Active Directory server (section 4.5.1) cannot be accessed.
Archive failed -(message)	Message explains archive failure.
Battery-backed RAM cleared	This message appears if the battery has failed, and the unit has been switched off.
Clock failure	Internal clock was corrupt at power up, or the time has never been set. Can be caused by battery failure, in which case the battery icon will also be visible. The error is cleared by setting the time and date. Server time forced to 00:00 1/1/1900.
Channel error	Indicates a hardware failure in the channel circuit or in the internal CJ temperature measurement
Channel failure	Indicates a hardware failure in the input channel circuit (see note).
DHCP Server failure	For instruments with IP address lookup set to 'Get from DHCP Server', this alarm occurs if the recorder cannot obtain an IP address from the server. See section 4.5 for details.
FTP/(S)FTP Archiving file lost	Archive failed. A file which has not been archived, has been detected.
FTP/(S)FTP Archiving too slow	Remote archive is too infrequent. The recorder effectively switches to 'Automatic' (section 4.3.5) to ensure that data is not lost.
FTP/(S)FTP Primary Server Failure	This error is set if the recorder fails, after two attempts, to establish communications with the primary server as defined in Archive Configuration (section 4.3.5). After the second attempt has failed, the Secondary server is tried.
FTP/(S)FTP Secondary Server Failure	This error is set if the recorder fails, after two attempts, to establish communications with the secondary server as defined in Archive Configuration (section 4.3.5). See also 'FTP/(S)FTP Primary Server Failure, above.
Insufficient non-volatile memory...	There is insufficient memory available for the configuration. Can be caused by use of Rolling Average maths functions.
Internal flash: \application\ required repair	Error found in the internal file system at power-up, and corrected.
Internal flash: \history\ required repair	Error found in the internal file system at power-up, and corrected.
Internal flash: \screens\ required repair	Error found in the internal file system at power-up, and corrected.
Internal flash: \user\ required repair	Error found in the internal file system at power-up, and corrected.
Internal flash: \user\ is full	Appears if the User partition is full. To clear, either user screens must be simplified or files must be deleted from \User\, or both.
Maths Channel failure	Appears if, for example, the divisor of a divide function is zero.
Media Archiving file lost	Archive failed. A file which has not been archived, has been detected.
Media Archiving too slow	Archive is too infrequent. The recorder effectively switches to 'Automatic' (section 4.3.5) to ensure that data is not lost.
Network boot failure	The recorder is unable to establish connection with the BootP or DHCP server. This might be caused by, for example, cable failure, network hardware failure, etc.
Output channel failure	Indicates a hardware failure in the output channel circuit (see note).

Note: Unlike other instrument alarms, Channel Failure and Output channel failure are not self clearing. Once the cause of failure is rectified, the recorder must be power-cycled in order to clear the alarm.

3.1.3 ALARM INDICATION (INSTRUMENT ALARMS) (Cont.)

Paper Low/Paper Out Printer not responding	Warning messages from the ASCII printer (if fitted). There is a fault in the serial comms link with the ASCII printer (if fitted).
Recording failure - (message)	Message explains recording failure - due to file error, internal overflow etc.
Removable media failure	This error is set if the archive storage device is corrupt, wrongly formatted etc. Becomes active only when an Archive is attempted.
Removable media full	Archive storage device full. Becomes active only when an Archive is in progress.
SNTP server failure	This error is set if:- a) the year received from the server is < 2001 or > 2035 or b) the configured SNTP server cannot be accessed.
Time synchronisation failure	Set if 5 or more 'Time change events' are caused by the SNTP server within 24 hrs. A 'Time change event' occurs whenever the recorder time is found to be more than 2 seconds different from the server time. The alarm does not appear until 24 hours have elapsed since the first of the five or more Time Change events occurred.
USB over current	USB power fault - too much current being drawn by a USB device (max 500 mA).
USB power fault key	USB power fault - too much current being drawn by all USB devices (max 1100 mA)
USB unsupported	Unsupported USB device inserted.

3.1.3 ALARM INDICATION (Cont.)

CHANNEL ALARM

This red 'bell' indicator appears if any channel is in alarm. The symbol is illuminated continuously if all alarms are acknowledged or flashes if any active alarm is unacknowledged. Refer to 'ALARM ACKNOWLEDGEMENT' below, for details of how to acknowledge alarms.

CHANGE BATTERY

This flashing indicator first appears when the battery voltage (checked every 15 minutes) indicates that the battery is approaching the end of its useful life. The indicator continues to flash until the battery is replaced ([B2.2 in Annex B](#)). The indicator does not appear if the battery is not fitted.

DISK ICON

This shows the free space available on whatever mass storage medium is fitted (if any), and selected for Archive destination (note 1). The disk icon appears soon after the device is inserted (but see note 2). During archiving, the colour of the central area of the disk changes to green (see note 3). No other disk activity (e.g. save/restore configuration) is indicated.

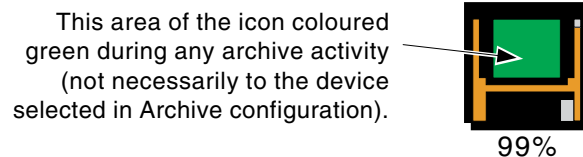

Figure 3.1.3 Archive activity indication

Notes

1. The icon appears only when a memory device is present, AND when that memory device has been selected in the 'Archive to media' selection in archive configuration ([section 4.3.5](#)). For example: if a memory stick is inserted in 'usbfront', but Archive to Media is set to 'mediacard', then the disk icon appears only if a suitable card is present in the 'mediacard' slot.
2. When a disk is inserted into a USB floppy disk drive which is connected to the recorder, the disk icon appears only after the disk has been accessed, (either by reading from it or writing to it), or after the file system has been opened by touching the 'file' key. (This note does not apply for disks which have been inserted before the disk drive is plugged in.)
3. The central area goes green whenever local archiving is taking place - not only when archiving is taking place to the memory device selected in Archive configuration.

FTP ICON

The FTP (or (S)FTP) icon appears to the right of the disc icon position whenever transfer activity is taking place.

CONFIGURATION LOCKED INDICATOR

This symbol appears only when Bridge software is being used, in the following situations:

1. Whilst units are 'synchronising' configuration changes
2. Whilst configuration is taking place. If the reconfiguration is taking place at the host pc (Bridge 'Full' only), then the symbol appears at the target instrument, and vice-versa.

TRIAL MODE INDICATOR

This symbol is displayed whilst the recorder Trial Mode ([section 4.3.22](#)) is enabled.

3.1.4 Summary menu

This pop-up display appears if the Alarm Indication area at the top of the display is touched. Figure 3.1.4a shows the display.

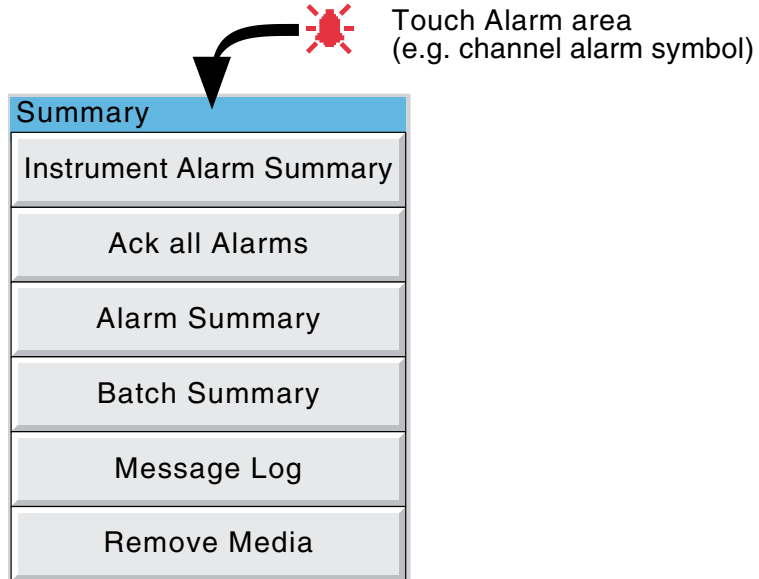

Figure 3.1.4a Summary pop-up menu

INSTRUMENT ALARM SUMMARY

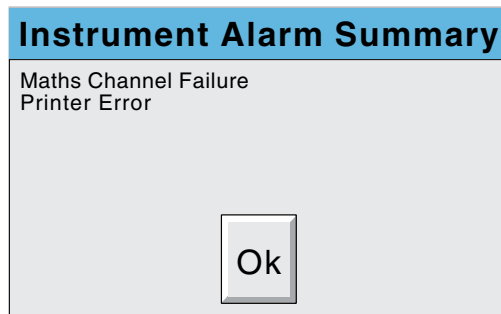

Figure 3.1.4b Typical Instrument alarm summary display

This contains a list of the currently active instrument alarms. For a list of possible alarms and their definitions, see [section 3.1.3](#), above.

ACK ALL ALARMS

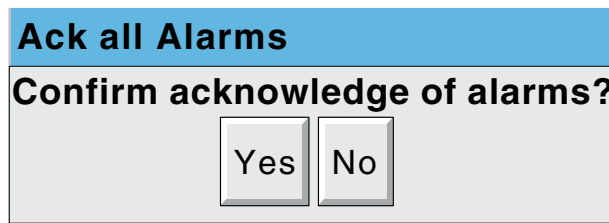

Figure 3.1.4c Ack all Alarms display

'Yes' confirms all active, unconfirmed alarms.

This page can also be displayed by touching an alarm in the alarm summary page, described below.

3.1.4 SUMMARY MENU (Cont.)

ALARM SUMMARY PAGE

As shown in figure 3.1.4d, below, the alarm summary page contains the following information for the current group:

1. Alarm identifier. This appears as a point ID, followed by the relevant alarm number in parentheses. For example, Alarm 1 on maths channel 6 would appear as: D6 (1). Maths channels are prefixed by 'D'. Totalisers are prefixed by 'T' and Counters are prefixed by 'C'. Input channels are not prefixed.
2. Alarm threshold for absolute alarms only
3. The current process value for the point
4. An alarm symbol (see Table 3). Alarm symbols flash until acknowledged.

Notes:

1. Alarms are always listed in Point/Alarm order with input channels first, followed by derived channels, totalisers and counters, if these options are fitted.
2. When the alarm source returns to its non-alarm state: Unlatched alarms are removed from the list whether or not they have been acknowledged; latched alarms remain displayed until acknowledged. See section 4.3.3 for a description of alarm types and actions.
3. There are no time or history components associated with the Alarm Summary. If Alarm messages have been enabled in the relevant group's configuration (section 4.3.2), then alarm initiation/acknowledgement times and dates can be found from the trend and trend history displays, described in section 3.4 or in Message log described later in this section.
4. If an alarm is active on a channel which is not included in any group, then although the channel alarm symbol will flash, the alarm will not appear in any of the alarm summary pages.

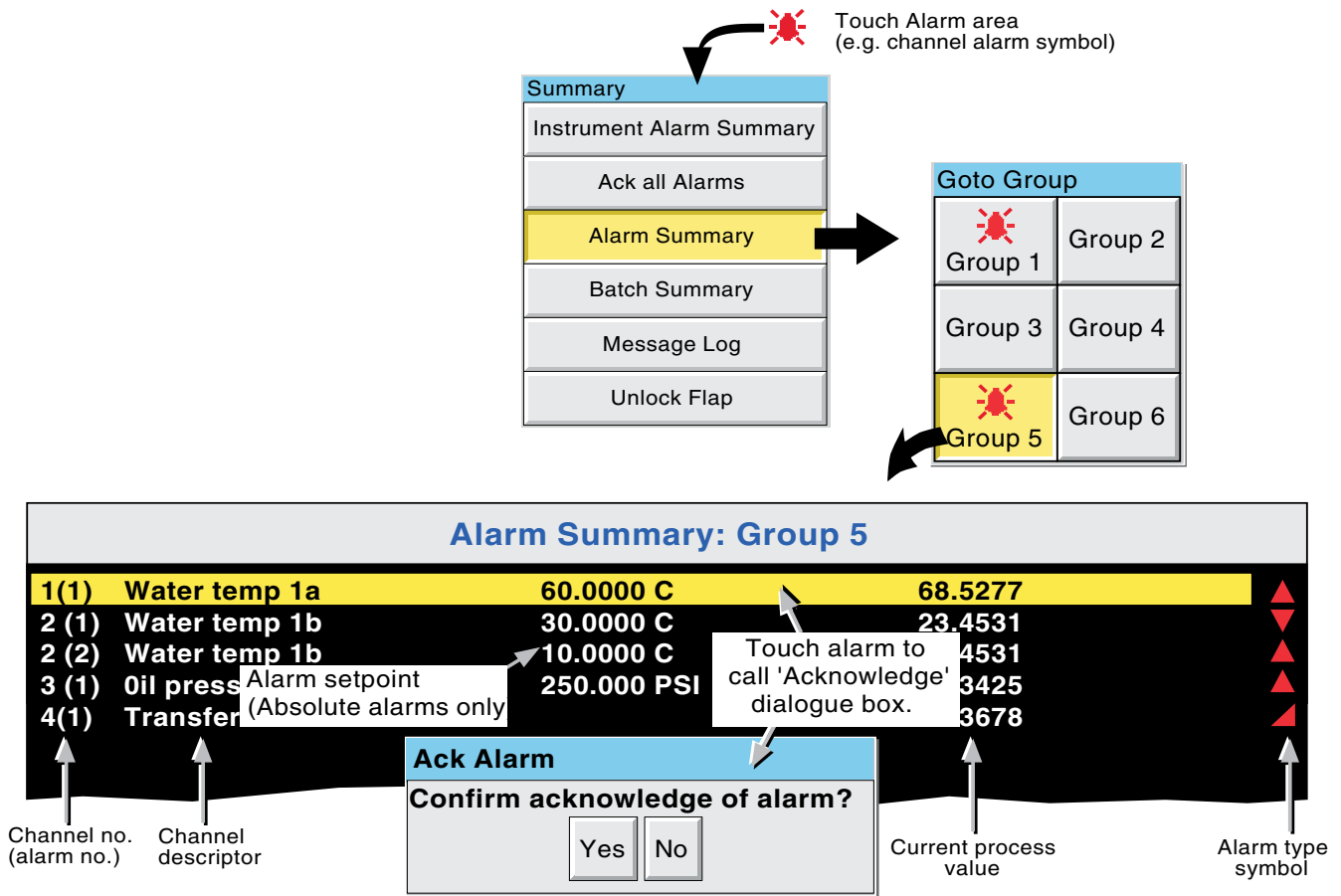

Figure 3.1.4d Alarm Summary display

3.1.4 SUMMARY MENU (Cont.)

ALARM ACKNOWLEDGEMENT

Alarms can be acknowledged individually, on a group basis, or globally (all alarms).

INDIVIDUAL ALARMS

Individual alarms are acknowledged from the alarm summary page by touching the relevant item (highlights yellow), then touching 'Yes' in the resulting pop-up confirmation box. Figure 3.1.4d, above, attempts to show this process.

GROUP ALARMS

Alarms can be acknowledged on a group basis by calling the alarm summary page for the relevant group, then pressing the Options key (section 3.2), the 'Ack Group Alarms' key and finally, 'Yes' in the resulting pop-up confirmation box. Figure 3.1.4e below, attempts to show this process.

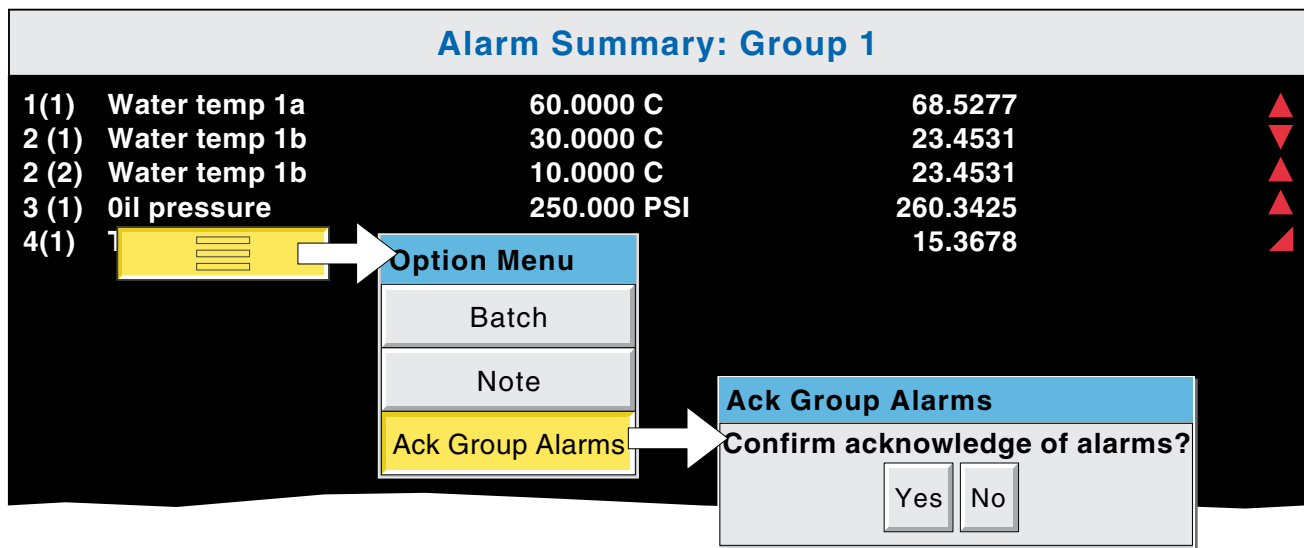

Figure 3.1.4e Group Alarm acknowledgement

ALL ALARMS

To acknowledge all active alarms, touch (e.g.) the channel alarm icon at the top of the screen. From the resulting 'Summary' menu, select 'Ack all Alarms', then finally, touch 'Yes' in the resulting pop-up confirmation box.

Note: The options menu is context sensitive, and may, therefore, not appear as illustrated above.

3.1.4 SUMMARY MENU (Cont.)

BATCH SUMMARY

If the Batch option is fitted (section 4.3.10) a 'Batch Summary' key appears in the Summary menu.

Note: The following description shows the situation where batch 'Scope' is configured as 'Group'. The description is similar when 'Scope' = 'Instrument' except that there is only one line (Instrument), instead of one line per group.

As shown in figure 3.1.4f, below, the Batch Summary page contains the following batch information:

1. Group names in group number order (if Scope = Group) or Instrument Name if scope = 'Instrument'
2. Batch active indicator (green spot)
3. Initiation time and date
4. Elapsed time for the batch
5. Batch Field 1 and its 'value'.

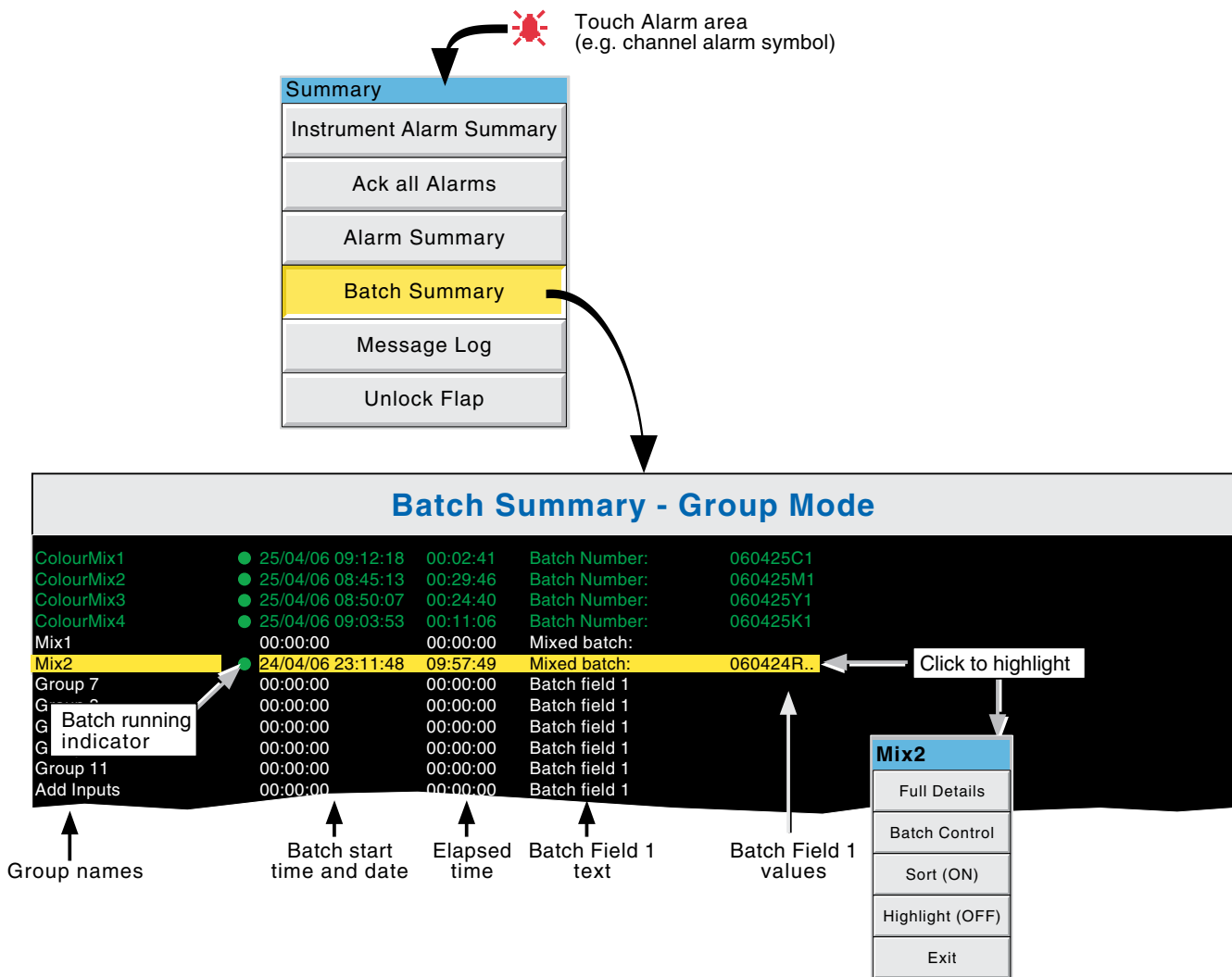

Figure 3.1.4f Batch Summary page (Group mode - sort OFF; highlighting ON))

Touching anywhere on a group row calls a pop-up menu as shown above. The functions of this menu are as follows:

3.1.4 SUMMARY MENU (Cont.)

BATCH SUMMARY (Cont.)

FULL DETAILS

Touching this key calls the Batch Details page showing the group name, batch status and batch field details.

BATCH CONTROL

This calls a page similar to the Full Details page, but including a 'NEW' key to allow the operator to start a new batch. If the batch is configured as 'Start/Stop' a 'Stop' key is also included allowing the user to stop the batch.

SORT

If Sort is Off (default), the groups appear in Group number order with Group 1 at the top and group 12 at the bottom. The key legend is 'Sort (ON)'.

If Sort is On, those groups with batches running appear (in group number order) at the top of the list, followed by any remaining groups (also in group number order). The key legend is 'Sort (OFF)'.

HIGHLIGHT

If Highlight is Off (default), then all groups' text appears in white. The key legend is 'Highlight (ON)'.

If Highlight is On then the text associated with groups which have batches running appears in green. Remaining groups' text is in white. The key legend is 'Highlight (OFF)'.

EXIT

Closes the pop-up menu. (It closes itself after approximately 50 seconds.)

3.1.4 SUMMARY MENU (Cont.)

MESSAGE LOG

Note: Message log can also be selected using the Root menu/Goto View/Message log key. This goes immediately to the first Message Log page for the current group to the screen (i.e. the 'Goto Group' menu does not appear).

If there are more messages than can be displayed in the height of the screen, a scroll bar appears to allow 'hidden' messages to be displayed.

Messages are retrieved from the history files in batches of 100 messages. If there are more than 100 messages, 'Earlier messages..' appears after the hundredth message. Touching 'Earlier messages..' calls the option menu, and touching 'Earlier messages..' in this menu, calls the next batch of 100, and so on. If applicable, operating 'Later messages..' / 'Later messages..' calls the previously displayed 100 messages.

As can be seen from figure 3.1.4g the list of messages can be 'filtered' both by type and by time. For example, setting the message type to 'Alarm' and the period filter to 'Last Day' excludes all messages except alarm messages which have occurred within the previous 24 hours. (For clarity, the figure shows both filters open. In fact, only one can be open at a time)

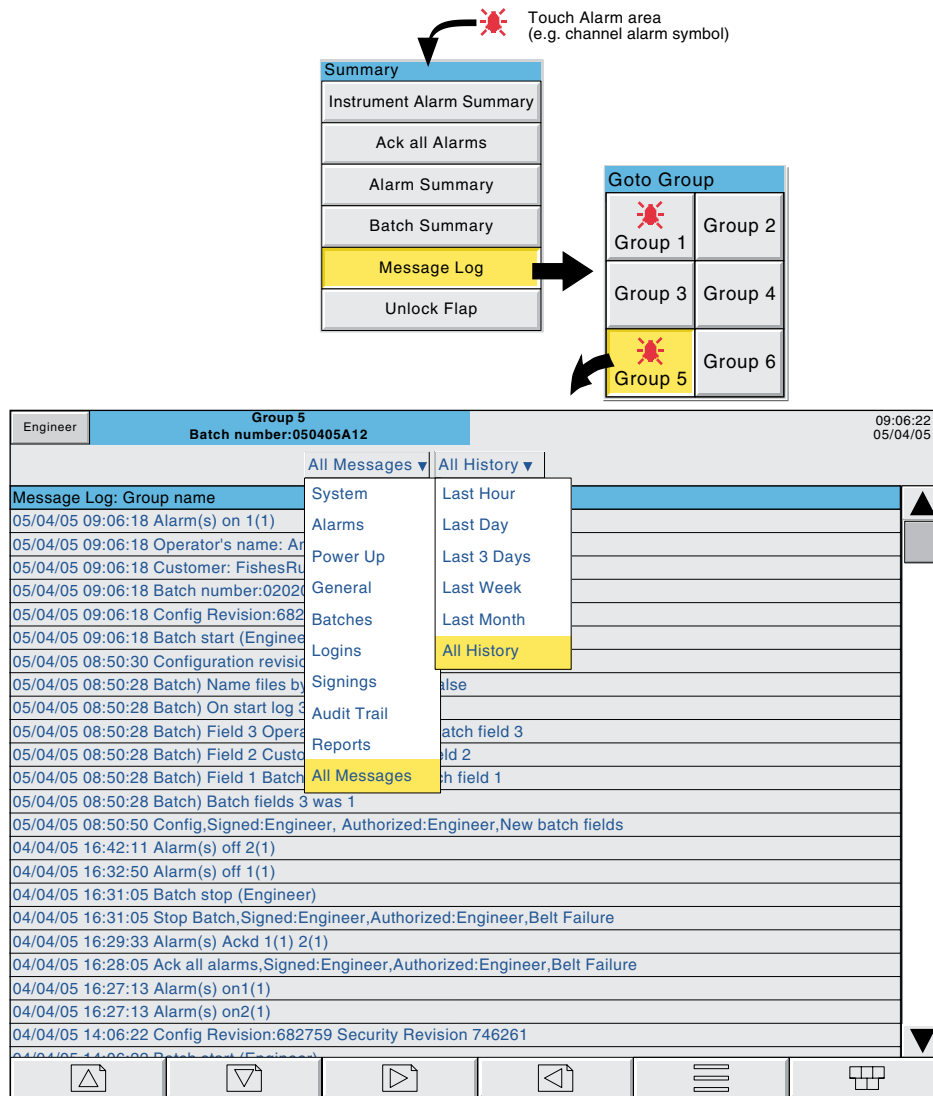

Figure 3.1.4g Message log page showing message-type picklist

3.1.4 SUMMARY MENU (Cont.)

MESSAGE LOG (Cont.)

MESSAGE TYPE FILTER

All Messages	All messages are displayed
System	Only System messages and instrument alarms are listed
Alarms	Only alarm on/off and acknowledgement messages appear.
Power Up	Displays power up messages only including Config Revision and Security revision are included. See 'About' (section 4.6.11) for more details.
General	Displays e-mails, messages sent via Modbus, operator notes/custom messages etc. if they do not have to be 'signed' (Auditor option 21CFR11 only - see section 4.4 for more details). If the notes etc. are signed, they appear in the 'Signings' message type list.
Batches	Displays only batch messages (including Config and Security Revisions if either Auditor option is enabled).
Logins	Lists only changes in login.
Signings	This list contains only notes, messages etc. that have been signed (and authorized). This category is used only when 'Require Signing' (and 'Require Authorization') is (are) enabled in the Security/Management menu- see section 4.4 for more details.
Audit trail	This list contains Configuration change messages only. This category is used only when 'Audit Trail' is enabled - see section 4.4 for more details.
Reports	For each report, this contains all the Report's fields (set up in 'Reports' configuration) on separate lines. Line Feed fields are ignored (i.e. they do not appear).

PERIOD FILTER

This picklist allows the user to select one of the following to define the period of time that the message list is to encompass:

All History, Last Month (28 days), Last Week, Last 3 Days, Last Day or Last Hour.

3.1.4 SUMMARY MENU (Cont.)

MESSAGE LOG (Cont.)

OPTION MENU

Touching a message (highlights yellow) calls the Option Menu* as shown in figure 3.1.4h, below.

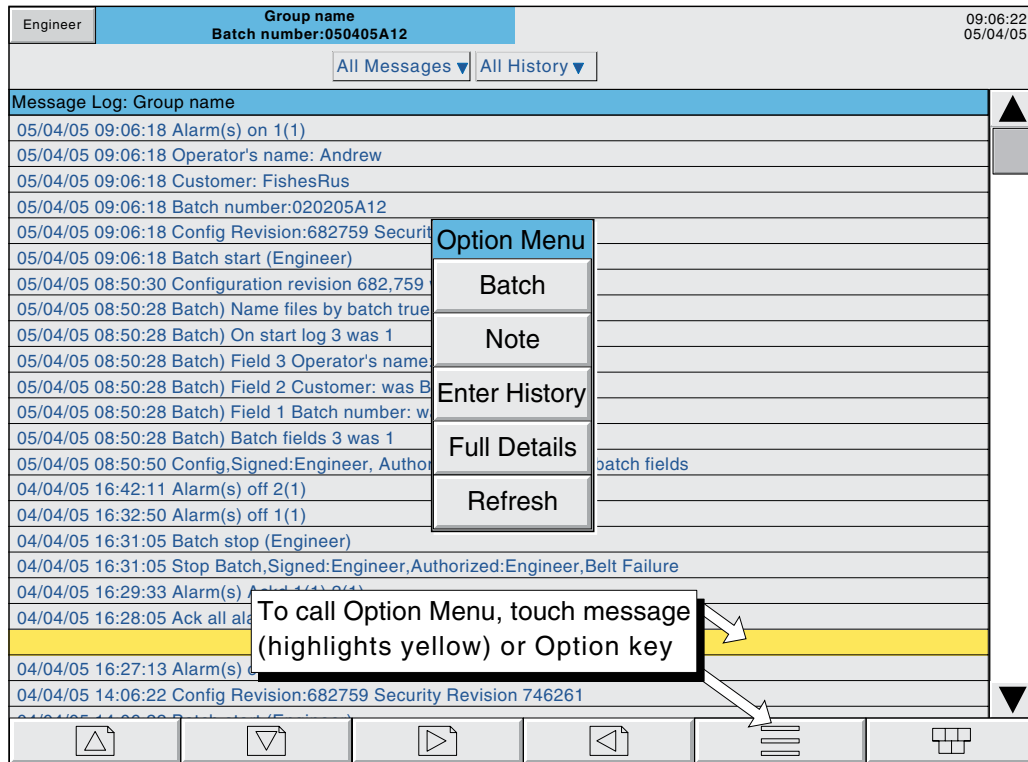

Figure 3.1.4h Message Log options menu

Batch	See section 4.3.10 .
Note	See section 3.5 .
Enter history	Operating the Enter History key causes the recorder to display that page of history which includes the highlighted message. See section 3.4 for details of trend history. When in Trend history mode, operating the Message Log key calls that message log page which contains those messages which are nearest the trend history cursor time.
Full details	If the highlighted message is wider than the display, the whole message can be displayed by operating the 'Full Details' key.
Refresh/Earlier messages../Later messages..	'Refresh' places (at the top of the screen), any messages, which have occurred since the Message Log page was last entered, or since the last 'Refresh'. If earlier or later messages have been selected, then 'Refresh' is replaced by 'Earlier messages..' or 'Later messages..' as appropriate, and operating the key calls the next or previously displayed group of 100 messages to the display respectively.

* The option menu can also be called by touching the option key. In this case:

- Enter History calls the current Trend History display, as described in [section 3.4](#), and
- Because no message is highlighted, the 'Full Details' key is not enabled,

Notes:

- Selecting 'Enter History' whilst either 'Earlier Messages' or 'Later Messages' is highlighted calls the current History page.
- If the Option Menu has 'timed out' leaving a message highlighted, and the option key is operated, then this is equivalent to reselecting the message.

3.1.4 SUMMARY MENU (Cont.)

REMOVE MEDIA

Note: See [section 2.4](#) if the 'Lockable Door Flap' option is fitted.

This key is provided to help ensure that any local memory storage device is removed only when it is 'safe' to do so.

Touching the key results in either an 'OK to remove archive media', or a 'DO NOT REMOVE Archive Media! message, as appropriate. See figure 3.1.4i

CAUTION

Removal of memory devices such as SD cards or Compact Flash cards whilst archiving is taking place can lead to permanent, irreparable damage to the device, rendering it unusable.

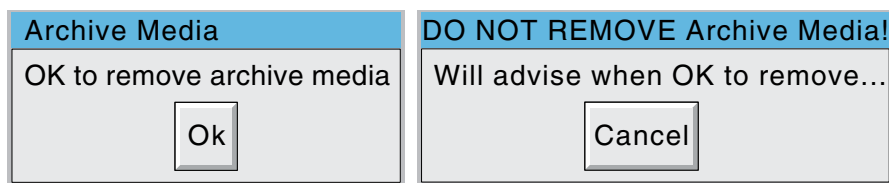

Figure 3.1.4i Remove archive media messages

3.2 NAVIGATION KEYS

Above the lower edge of the display screen are six keys (as shown below, for the small frame unit) which allow the user to perform various context-related tasks such as to change the display mode ([section 3.4](#)), to access the recorder configuration, to archive data, to select groups etc. In addition to this, left and right arrow keys or open/close folder keys appear when relevant.

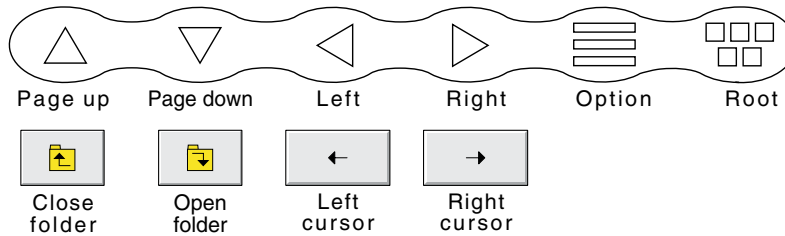

Figure 3.2 Navigation keys

3.2.1 Key functions

Page up	Used, as appropriate, to recall the previous (higher level) display page, to call the previous display mode and to scroll through previous text entries. Where relevant, the function of this key is mimicked by the 'Close folder' key.
Page down	Used, where appropriate, to call a further (lower level) display page, to call the next display mode and to scroll through previous text entries. Where relevant, the function of this key is mimicked by the 'Open folder' key.
Left arrow	Used a) to select the previous group, b) to navigate backwards through a text string when editing or c) to select the previous channel whilst in configuration. Where relevant, the function of this key is mimicked by the 'Left cursor' key.
Right arrow	Used a) to select the next group, b) to navigate forwards through a text string when editing or c) to select the next channel whilst in configuration. Where relevant, the function of this key is mimicked by the 'Right cursor' key.
Option	Calls a pop-up Options menu allowing the user to carry out functions such as entering/quitting history, turning channel cycling on and off etc. according to context.
Root	Calls the 'Root Menu' as described below. To quit the Root menu, touch the root key again.

ROOT MENU KEYS

Home	Causes a return to the 'Home' page from any page in the recorder. As delivered, the 'Home' page is the Group 1, vertical trend display as depicted in figure 3 , but this can be edited (in Config/Views) to be any of the other available groups' display modes - Horizontal trend, Vertical bargraph etc.
Operator	Causes the top level Operator page to appear. The appearance of this display is dictated by the security level that the recorder is set to, and by the access level of the user. As despatched from the factory, the recorder is in 'logged out' mode and the Operator page contains only 'Archive', 'Security' and 'System' keys. Further details appear in 'Access to configuration' below.
File	Allows the file system in that area of Flash memory that is accessible to the user, and the file system on any bulk storage device fitted, to be viewed. See section 5 for details.
Remove Media	This key is provided to help ensure that any local memory storage device is removed only when it is 'safe' to do so. Touching the key results in either an 'OK to remove archive media', or a 'DO NOT REMOVE Archive Media! message, as appropriate. For more details see section 3.1.4 .
Unlock Flap	Replaces 'Remove Media' (above) for recorders fitted with the lockable flap option (section 2.4).
Goto View	Allows the user to select the display mode for the current group, as shown in figure 3.2.1a . Display modes not enabled for this group in Config/Views configuration page (section 4.3.4) do not appear. As an alternative, display modes can be scrolled-through using the up and down arrow navigation keys. Goto View also offers an alternative means of entry to the Alarm Summary page described in section 3.1.4 , and also allows entry to the current group's Message Log pages, described below.

3.2.1 KEY FUNCTIONS (Cont.)

ROOT MENU KEYS (Cont.)

Goto Group Allows a group to be selected for display. Groups which are not 'display enabled' in the Config/Views page (section 4.3.4) are greyed. An alarm icon appears (as shown for groups 1 and 4, in figure 3.2.1b, below) for any group containing one or more points in alarm. The icon flashes if any of the group's alarms have not been acknowledged.

Notes:

1. If there is insufficient space on the display screen for all the enabled groups or views, 'More...' keys appear, as necessary, to allow further items to be displayed for selection.
2. In normal operating (e.g. trend) displays, the right arrow key can be used to scroll through groups in ascending group number order. The left arrow key can be used to scroll through groups in descending group number order.

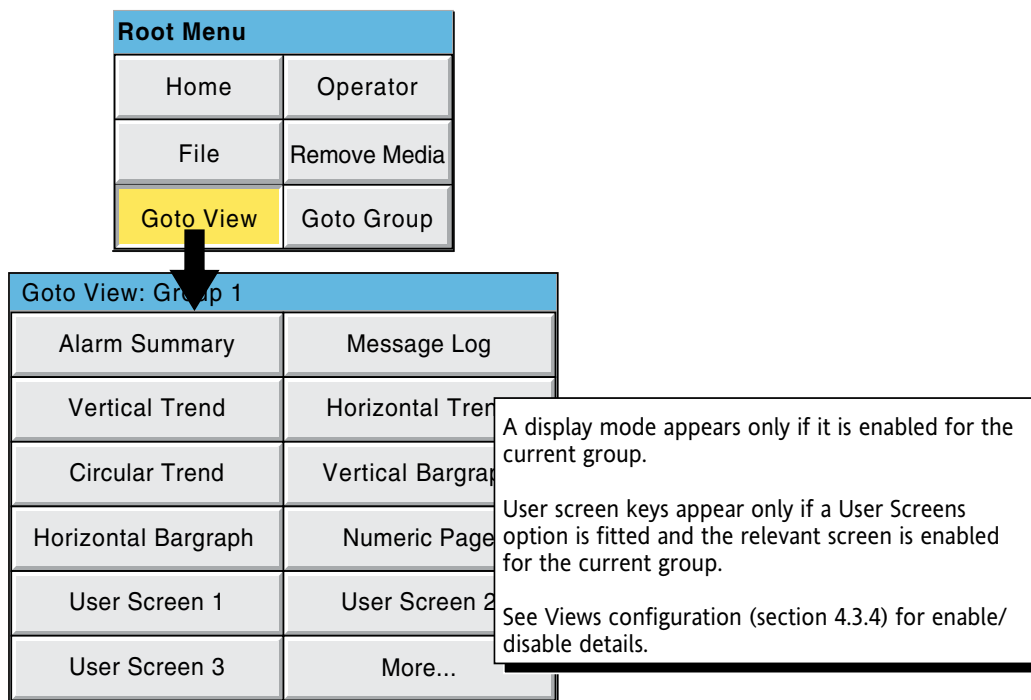

Figure 3.2.1a Root menu with Goto View sub menu

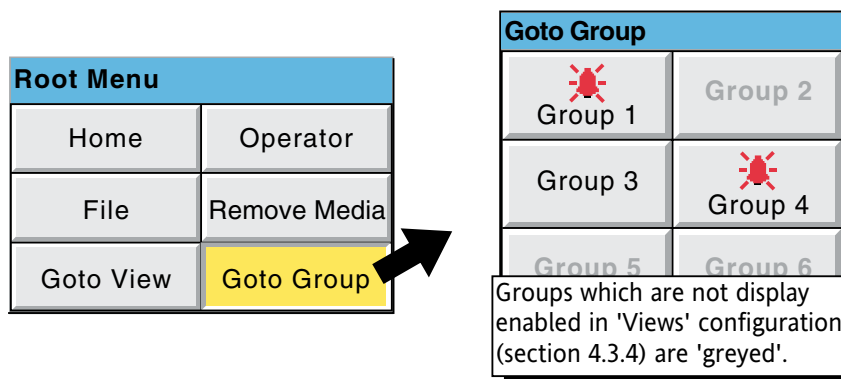

Figure 3.2.1b Root menu with Goto Group sub menu

3.2.1 KEY FUNCTIONS (Cont.)

ALARM SUMMARY:

The Root menu/Goto View/Alarm summary key calls the Alarm summary page for the current group to the screen. Alternatively, Alarm summary can be selected from the Alarm, Message and Media menu, but in this case, the user must select an alarm summary group from a pop-up (Goto Group) menu. See [section 3.1.4](#) for more details of the alarm summary page.

MESSAGE LOG :

The Root menu/Goto View/Message log key calls the Message Log page for the current group to the screen. Alternatively, Message Log can be selected from the Alarm, Message and Media menu, but in this case, the user must select a 'Group' for the Message Log display from a pop-up (Goto Group) menu.

See [section 3.1.4](#) for full details of the message log.

3.3 FIRST SWITCH-ON

When power is applied the recorder initialises, and once this process is complete, the Engineer password configuration page is displayed. See [3.3.1 Initial Setup](#) and [Engineer Password - Configuration](#) for further details. Once the Engineer password configuration is completed the Home page is displayed. It is unlikely that this will contain any useful information because the input channels will not, as yet, have been configured to suit the type of input signals being applied to them, as described in [section 4](#).

Notes:

- 1 There is no on/off switch associated with the recorder.
- 2 Date, time and the message 'Power Up' are printed on the chart each time power is applied to the recorder, followed by a similar message giving 'Config Revision' and 'Security Revision'.
- 3 A red line is drawn across the width of the chart at power up

3.3.1 Initial Setup

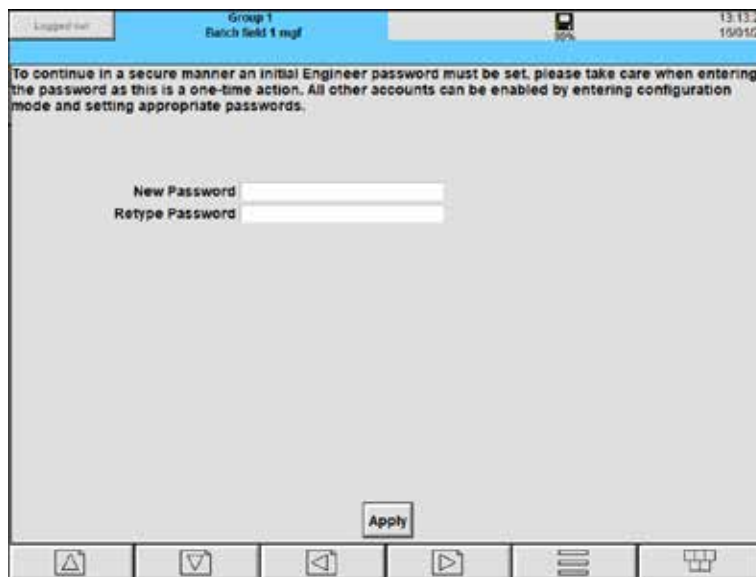

Figure 3.3.1 Engineer password configuration screen - at initial start

At first switch on, after installation the unit will display the Engineer password configuration screen, see [Figure 3.3.1 Engineer password configuration screen - at initial start](#). The Engineer password must be configured to allow any further operation, see [Engineer Password - Configuration](#) on page 31.

Note: The Engineer password configuration screen will also appear after a Clone file load or firmware upgrade, if the engineer password was not pre-configured. Furthermore, all user accounts require an associated password.

Engineer Password - Configuration

CAUTION: ENGINEER ACCESS DENIED

When configuring the Engineer password, ensure the password can be recalled and entered correctly. An incorrect password will prevent Engineer access (lock out) and any further configuration or use of the recorder. Contact your local Eurotherm support desk in the unlikely event of being locked out.

Note: Please read the following information regarding the units display screen and navigation controls to familiarize yourself with all the controls and their associated functions, see [3.2 NAVIGATION KEYS](#).

1. From the Engineer password configuration screen, enter a new password by selecting the *New Password* field.
The *New Password* panel appears, displaying a keyboard (see example [Figure 3.3.2b Alphabet 1 keyboard](#)).
2. Enter a password using the keyboard, once you have completed typing a Engineer password, press the *Ok* button.
The Engineer password configuration screen appears.
3. Re-enter the new Engineer password by clicking into the *Retype Password* field. Use the keyboard to enter the password and click *Ok*.
The Engineer password configuration screen displays with the password(s) hidden.
4. Click *Apply* to complete the Engineer password configuration.
The *Home* page appears. (The access level will default to *Logged out*).

The Engineer password must be configured at first switch on, but can also be updated when required. The Engineer password must only be associated with and used when logging in at Engineer level access, for further details see:

- [Security levels - Access levels](#)
- [3.3.2 Access to Configuration - Logging in](#)
- [4.4 SECURITY - Security, adding new users and updating passwords](#)

SECURITY LEVELS

The recorder has the following security levels:

Logged out	No access to recorder configuration is possible. Only Archive, Login/Security and the System 'About' functions can be accessed - via the root menu. Limited or full access can be permitted from 'Engineer' level.
Engineer	Available once the Engineer password configuration has been completed at first turn on, (see 3.3.1 Initial Setup). Provides full access to all recorder functions. Section 4.4.1 describes how the Engineer level password can be edited, along with enabling the Operator access level and setting the password option - where required. (The section also describes how access permission to some or all of the recorder functions can be granted, or not, to individual user names and default security levels).
Operator	Available once a user with 'Engineer' level access has enabled and configured the Operator access permissions. Section 4.4.1 describes how limited or full access can be permitted.

3.3.2 Access to Configuration

- 1 Touch the Current access level key, the 'Login' panel will appear.
- 2 Touch the 'Logged out' field and then touch 'Engineer' from the resulting picklist.
- 3 Touch the blank Password area to call the keyboard display (see figure 3.3.2b).
- 4 Using the keyboard enter the Engineer password and touch 'Ok'. (See 3.3.1 Initial Setup).
The screen reverts to the 'Home' page, with the access level 'Engineer' displayed.

Operation of the Root key followed by a touch on the Operator key calls the top level page allowing access to the [Archive](#), [Save/Restore](#), [Config](#), [Security](#), [Network](#) and [System](#) areas described in [section 4](#) below.

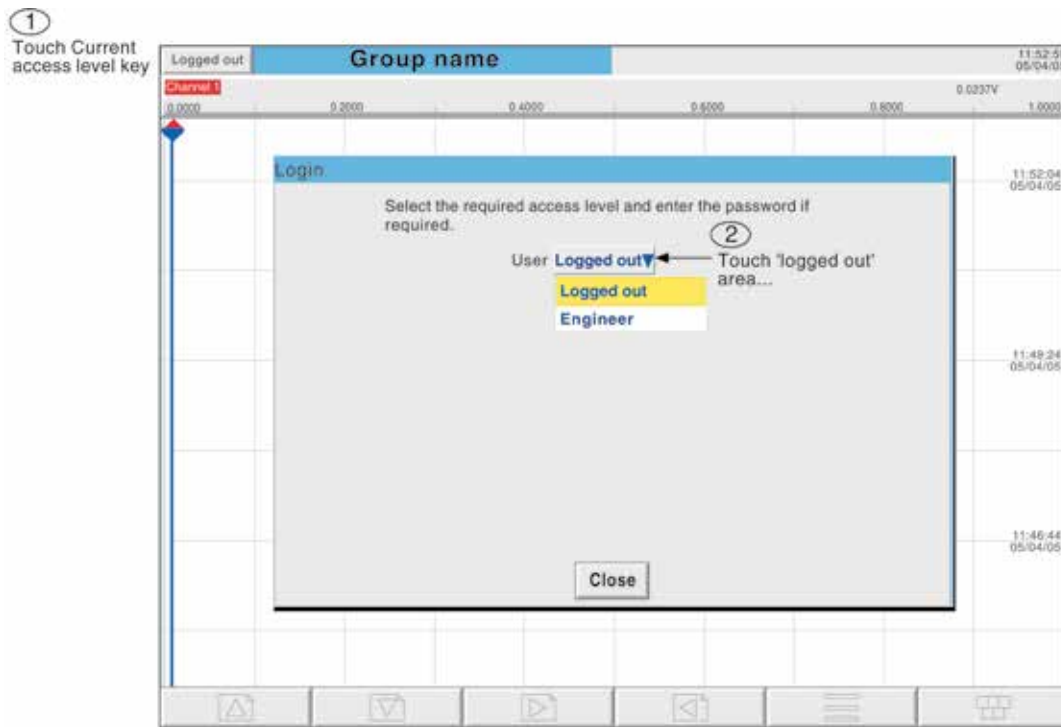
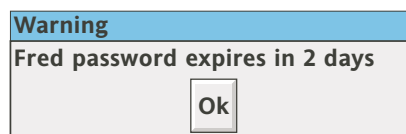

Figure 3.3.2a Access to configuration

Notes:

1. For units which have the Auditor 21CFR11 Option enabled, the Operator access level must be enabled by the Engineer and set a password where required. (No password is the default). The Operator access level password can be edited in 'Security' configuration ([Section 4.4.1](#)).
2. The login screen, above, can also be called by operating the Root menu, then 'Operator' then 'Security', then 'Login'. In such a case, the screen reverts to the 'Operator' page rather than returning to the home page once login has been achieved.
3. Figure 3.3.2a shows 'Login by user list' which is the default method. If either Auditor option and/or the Security management option is enabled, an alternative procedure is possible where each user has to enter a name and associated password - i.e. there is no list of users/access levels to choose from. See [section 4.4.2](#) (Management) for details.
4. For Active Directory users, a password expiry warning message (below) pops up on log-in, stating how many days remain before the password expires (configured at the Active Directory server).



TROUBLE SHOOTING

For Active directory users, if login fails, check that the Active Directory Server system alarm is not active ([section 3.1.3](#)) and that one of the TLS options is enabled ([section 4.5.1](#)). At the Active Directory server, check that the password has not expired and that 'Change Password at next login' has not been enabled.

TEXT STRING ENTRY

The keyboard which appears when the password area is touched is the same as that which appears when any non-numeric text string entry is required (e.g. channel descriptor). Figures 3.3.2b and 3.3.2c below are an attempt, within the limitations of the illustrating process, to depict the available keyboards and thus the available character set. Actual entry of the text string is by touching the relevant keys.

When editing existing text strings, the existing text string appears highlighted, and will be replaced in its entirety by the first character entered. To avoid this, the left arrow key* can be touched to 'unhighlight' it. The down and up arrow keys can be used to scroll through previously entered text strings.

Immediately below the keyboard are six keys with the functions listed below. When active, the background colour changes to yellow for as long as the key is active.

Shift*	Once the shift key has been pressed, the next-entered letter appears as a capital; subsequent letters are in lower case.
Caps*	When pressed, all subsequent letters appear as capital letters until the Caps key is operated again
BSpC	This backspace key deletes character to the left of the cursor.
Ovr	If selected, the next-entered character replaces (overwrites) the existing character to the right of the cursor position. If not selected, the next-entered character is inserted into the existing text string at the cursor position.
Ok	Used to save the new text string and to return to the page from which the keyboard was called.
Cancel	Causes a return to the page from which the keyboard was called without saving the new string.

*Notes

1. The character on each display key is always a capital letter, whether or not the actual character being entered is in capitals or lower case.
2. The cursor keys mimic the function of the left and right arrow Navigation keys.
3. As an alternative, text may be entered using a suitable keyboard connected via the USB port behind the access flap or (if the relevant option is fitted) one of the USB ports at the rear of the instrument ([section 2.2.1](#)).

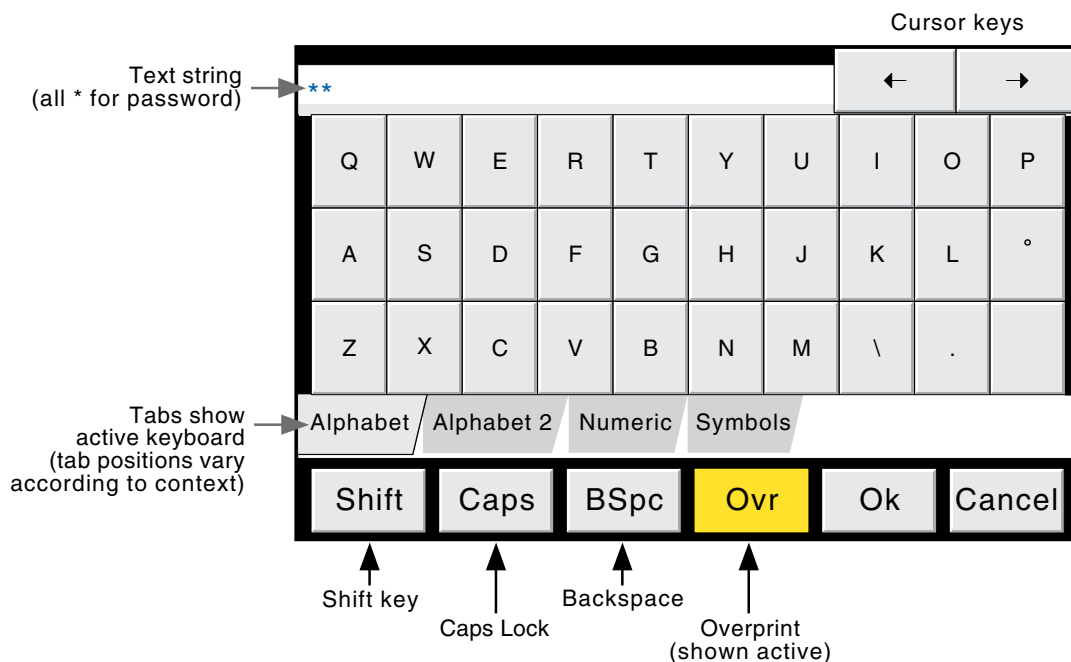

Figure 3.3.2b Alphabet 1 keyboard

3.3.2 ACCESS TO CONFIGURATION (Cont.)

TEXT STRING ENTRY (Cont.)

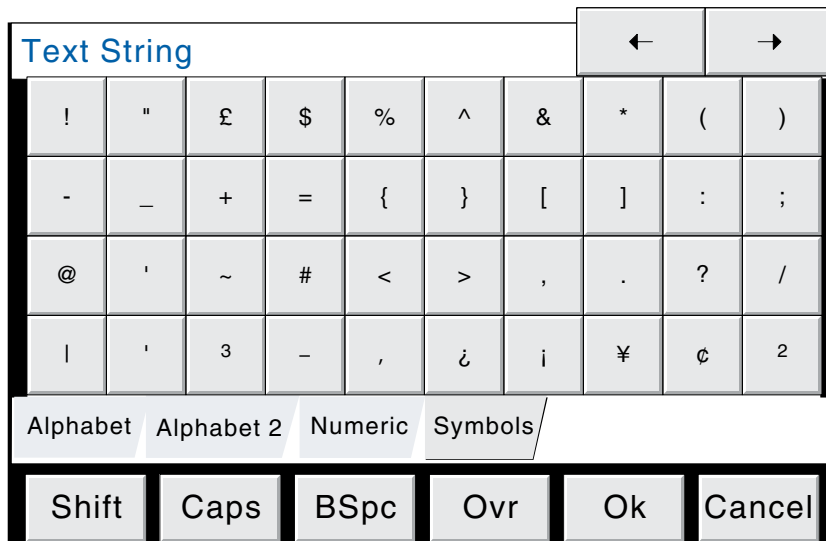
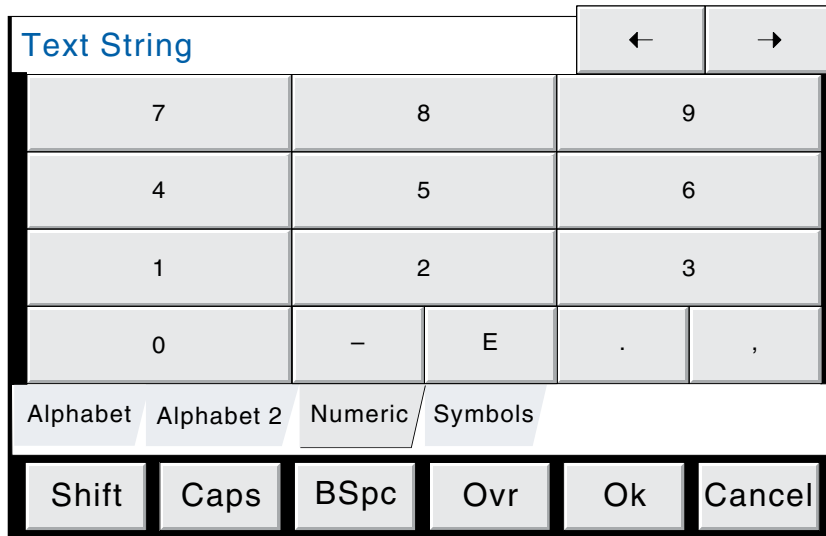
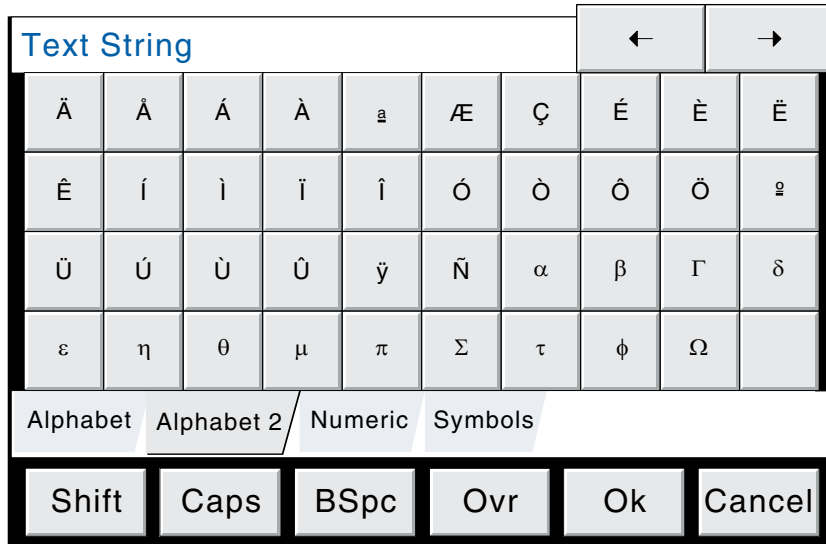

Figure 3.3.2c Alternative keyboards

3.4 DISPLAY MODES

The display modes described below allow the currently displayed group's process values (channels, totalisers etc.- known collectively as points) to be displayed as vertical, horizontal or circular 'chart' traces, as vertical or horizontal bargraphs or as numeric values. The various display modes are cycled-through using the up/down arrow keys, or a specific mode (or view) can be selected from the Root Menu 'Goto View' key. Groups can be scrolled through using the left/right arrow keys. The Home key returns the user to the Home page (defined in Configuration/Views - [section 4.3.4](#)) from anywhere in the Operator or Configuration pages in the recorder. When dispatched, the Home page is Group 1, vertical trend display. See also the Screen builder description in [section 7](#).

TREND HISTORY

Trend history, allows the user to review group history. The maximum amount that can be reviewed depends on a number of factors, including how many points are configured, how rapidly the traces are changing and so on. At a recording rate of 20 mm/hour (see group configuration - [section 4.3.2](#)), with all channels configured, a minimum of 30 day's worth of traces is available for viewing, provided that the group contents are not re-configured during this period (in which case, the history starts at the end of the re-configuration). The amount of trace visible on the screen depends on the recording rate, the higher the rate, the less trace is visible at any one time.

Notes:

1. Trend history mode is available only for groups with 'Recording Enable' enabled (Group configuration - [section 4.3.2](#)) and only for vertical, horizontal or circular trend display modes.
 2. Trend history mode is vertical for vertical and circular trend modes and horizontal for horizontal trend mode.
 3. Channel cycling is inhibited in trend history mode. To increment the current channel, touch the faceplate.
 4. Group faceplates are not displayed in trend history mode.
 5. Operation of the Root/Goto View/Message Log key ([section 3.2.1](#)), when in history mode, displays a message log page containing messages which occurred at or near the selected cursor time.
 6. With A/B switching selected, traces are displayed with the 'A' or 'B' span/zone, colour settings etc. obtaining at the cursor time. See sections [4.3.2](#), [4.3.3](#) and [4.7](#), for more details of A/B switching.
-

To enter trend history mode, the option key can be used (as shown for vertical trend mode in figure 3.4.1b), or the trace area of the screen can be continuously touched until the screen blanks prior to re-drawing. A 'Preparing History, please wait' message appears whilst the re-drawing calculation is taking place. Although tracing stops whilst trace history mode is active, no data is lost. Process Variable values are saved in the recorder memory. Alarms are still scanned-for and any associated action taken.

The trend history display is similar to the real-time trend display, but with a dark background and with the addition of a slider control and arrow keys for selecting that part of trend history which is to be displayed. The controls are used as follows:

- 1 Touching an arrow key causes the trace history to move an incremental amount.
- 2 Holding an arrow key continuously, causes continuous movement.
- 3 Touching and dragging the slider, whilst observing the time/date display, allows the user to select the section of history exactly. Touching the slider bar either side of the slider causes a page shift in the relevant direction. The Page up and Page down keys also provide this function.

On first entry to trend history mode, the channel value and the time and date shown in the faceplate are those at the top edge of the chart. Touching the screen causes a cursor to appear at point of screen contact. This cursor can be 'touched and dragged' to provide a reference point on the current trace. The displayed value date and time refer to the cursor intersection with the current channel. To return to real-time trending, the Option key is operated, followed by 'Exit History'.

3.4 DISPLAY MODES (Cont.)

TIME CHANGE RECORDS

For vertical and horizontal trend modes a line is drawn across the width of the chart whenever a time discontinuity in the record occurs. These lines disappear if a configuration change which causes group history to be lost, is made (such as adding a new channel to a group).

Red line A red line is drawn on the trend history chart at power up.

Blue line A blue line indicates that recording has been disabled/enabled in Group Configuration (section 4.3.2), or by a recording job (section 4.7.10). Blue lines are not drawn when the **Simulation Option** is active.

Green line A green line appears if there has been a time change as a result of a clock job (section 4.7.6), an **SNTP synchronisation** or by the operator physically changing the recorder time.

Note: Changes from standard time to daylight saving time and back again are not 'green lined' in this way

3.4.1 Vertical Trend display

This display (figure 3.4.1b) shows each point in the display group as though it were being traced on a white chart. It is possible to change the appearance of the chart in the System key 'Customise' area of configuration (section 4.6.10). It is recommended that some thought be given to ensuring good contrast between trace colours and background colour.

One of the channels is said to be the 'current' or 'scale' channel. This channel is identified by its diamond shaped pen icon and by its descriptor, digital value and scale being displayed on a 'faceplate' across the full width of the screen, above the chart. If a channel is included in the display group but its status is 'not good' for some reason, then its pen icon is hollow.

Faceplates for all the group channels can be displayed, by using the Faceplates On/Off key in the option menu. If selected On, faceplates (showing colour, descriptor, digital value and units) for all the group's channels appear either above the current channel's faceplate or, if there are too many to fit across the screen, at the right hand edge of the screen. When necessary, a slider bar appears to allow further (hidden) faceplates to be viewed.

Each channel in the display group becomes the 'current' channel, in turn, for approximately 10 seconds - i.e. the channels are cycled-through, starting with the lowest numbered channel. Once the final channel in the group has been displayed for 10 seconds, the lowest numbered channel is returned to and the sequence repeats. This scrolling process can be enabled or disabled using the Channel Cycling On (Off) key in the Option menu.

To select a particular channel to be the current channel, the relevant pen icon can be touched. To cycle through the channels manually, the faceplate area is touched repeatedly until the required channel is reached.

The **Horizontal Trend display** can be called using the down arrow key. Alternatively, any one of the enabled display modes (section 4.3.4) can be selected using the **Root Menu**, 'Goto View' key.

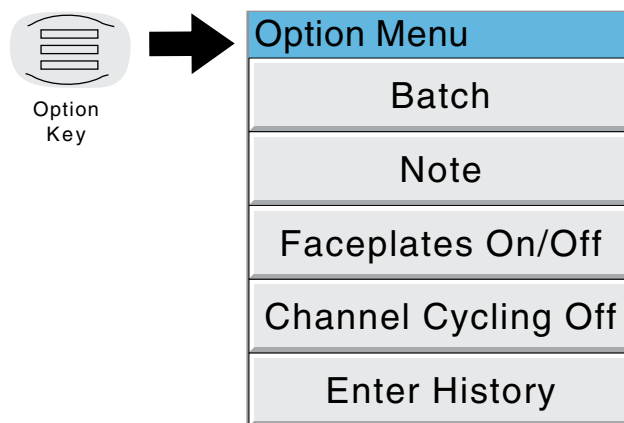

Figure 3.4.1a Option Menu (Typical)

3.4.1 VERTICAL TREND DISPLAY (Cont.)

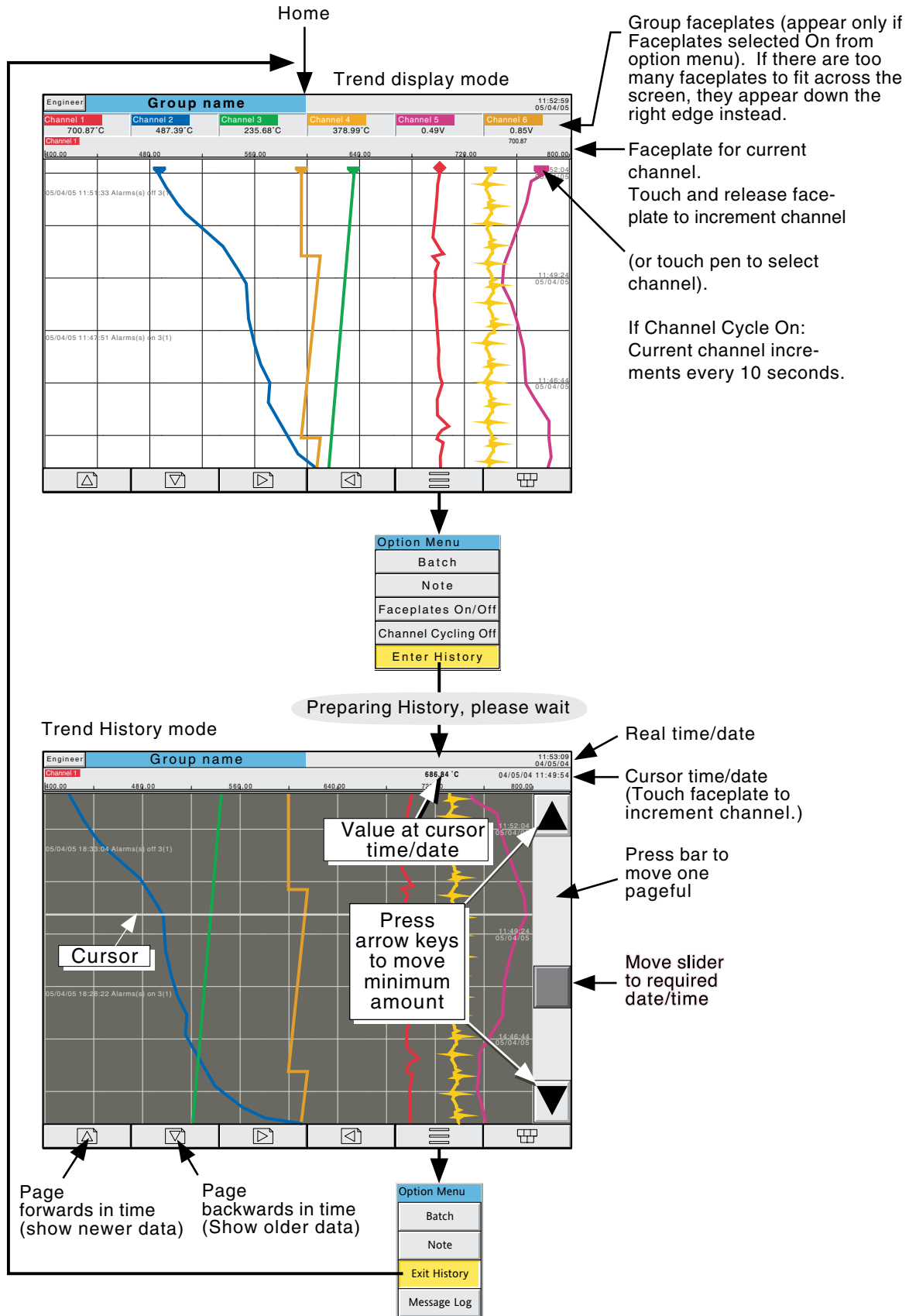

Figure 3.4.1b Trend display mode and trend history mode

3.4 DISPLAY MODES (Cont.)

3.4.2 Horizontal Trend display

Entered from the [Vertical Trend display](#) by means of the down arrow key, or selected via the Root Menu 'Goto View' key, this display mode (figure 3.4.2a) is similar to the Vertical Trend display described in section 3.4.1 above, except that the traces are produced horizontally rather than vertically.

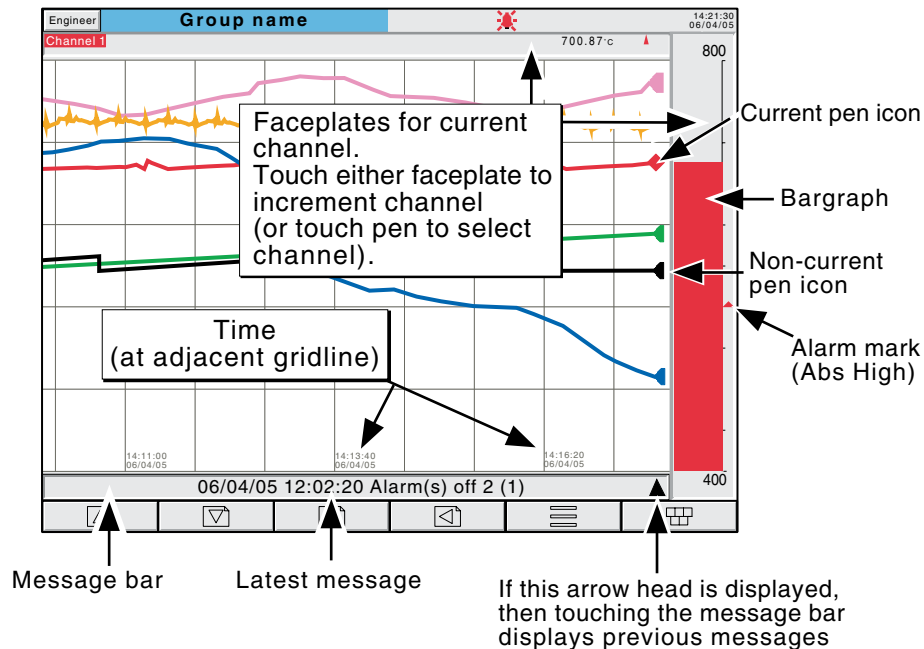

Figure 3.4.2a Horizontal Trend Display

One of the channels is defined as being the 'current' or 'scale' channel and this is identified on the chart by its pen icon being diamond shaped rather than triangular as for non-current channels. If a channel is included in the display group, but its status is 'not good' for some reason, then its pen icon is hollow. Each channel in the display group becomes the 'current' channel, in turn, for approximately 10 seconds - i.e. the channels are cycled-through, starting with the lowest numbered channel. Once the final channel in the group has been displayed for 10 seconds, the lowest numbered channel is returned to and the sequence repeats. This scrolling process can be stopped using the Channel Cycling key in the Option menu.

There are two faceplates associated with this display mode, one above the 'chart', showing the current channel's descriptor and its digital value; the other - to the right of the 'chart' - showing a bargraph representation of the current channel's value, together with a scale showing the low and high range values for the channel. Touching either of these faceplates causes the current channel number to increment. To select a particular channel to be the current channel, the relevant pen icon can be touched. In either case, the bargraph and the background colour of the channel descriptor take the colour of the new current channel.

Touching the trace for a few seconds, or using the Option key then 'Enter History' calls the Horizontal trend history page. See [section 3.4](#), above for more details.

Time and date are printed on the 'chart' immediately to the right of grid lines, and it is to these grid lines that the printed time and date relate.

3.4.2 HORIZONTAL TREND MODE (Cont.)

Below the 'chart' is a message bar, containing the latest message. If there is more than one message, an arrow head icon appears near the right-hand end of the message bar. If this arrow head appears, then touching the message bar calls a pop-up box (figure 3.4.2b) which displays the latest messages. If there are more messages than can be displayed in the box, a slider control appears, which can be used to access previous messages, up to a total of 60 messages. Further messages, cause the oldest messages to be discarded to keep the total to 60.

Note: At power-up, only those messages which occurred within the 'time width' of the page are displayed

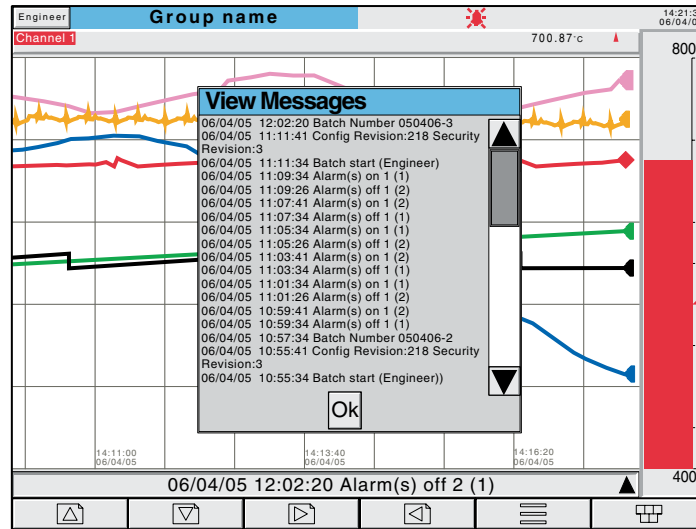

Figure 3.4.2b Horizontal Trend mode message dialogue box

The [circular trend mode](#), if enabled, can be called by using the down arrow key. Alternatively, any one of the enabled display modes ([section 4.3.4](#)) can be selected using the [Root Menu](#), 'Goto View' key.

3.4.3 Circular Trend

This allows up to 12 points to be traced as though on a circular chart. More than 12 points can be included in the group, but only the first 12 traces and their associated faceplates are included in the real-time display. Entering Trend History mode (by using the Options button or by continuously touching the screen for a few seconds), allows all the points to be reviewed, but only in vertical trend history mode, described in [section 3.4](#) above.

For large frame recorders, two alternative views called 'Full Screen' and 'Normal View' are available and are toggled between by means of a push-button key near the top left corner of the screen. In each case, faceplates can be displayed, or not, as required, using the Option key 'Faceplates On/Off' selection. The diameter of the chart is independent of faceplate on/off selection. When quitting History, Normal view is always returned to. Small frame recorders use only 'full screen' view, (except when viewed via Bridge software when the small frame recorder behaves in the same way as the large frame recorder).

Notes Alarm icons ([section 3](#)) do not appear on circular trend scales.

TREND MODES

The way in which traces are laid down on the chart depends on the action to be taken when the chart is 'full', as set up in group configuration - [section 4.3.2](#). The user can select 'Rotate' or 'New Chart'.

ROTATE

In the following description, the word 'segment' is used interchangeably with 'Major chart division'. The number of Major chart divisions is a function of the selected chart speed, as described in Group Configuration ([section 4.3.2](#)).

With 'Rotate' selected, the traces start one major chart division anti-clockwise from the top of the chart and trace clockwise until they reach the top of the chart ('12 o'clock'). At this point, the chart, complete with time stamps and traces, rotates one major chart division anticlockwise, and the tracing process continues. When the chart is 'full', the oldest segment-full of tracing is removed, leaving an empty segment to be traced-on when the chart rotates.

Figures 3.4.3b and 3.4.3c, below show Circular trending in 'Rotate' mode.

NEW CHART

With 'New Chart' selected, tracing starts at top of the chart (12 o'clock) and continue to trace clockwise round the chart, back up to the vertical. When the chart is full, it is cleared, new timestamps are displayed, and tracing restarts from the top of the chart.

The start time of the tracing can be set as a part ('Start at') of group configuration, the choices available depending on the time per revolution setting. The start time is placed at top centre of the chart, and 'backfilled', clockwise, round to the current time.

Figure 3.4.3a, below, shows New Chart mode.

Note: The use of '12 o'clock' above is intended to be illustrative and only to explain angles in terms of a normal analogue clock face. It does not mean that this position must actually be noon or midnight in real time.

3.4.3 CIRCULAR TREND (Cont.)

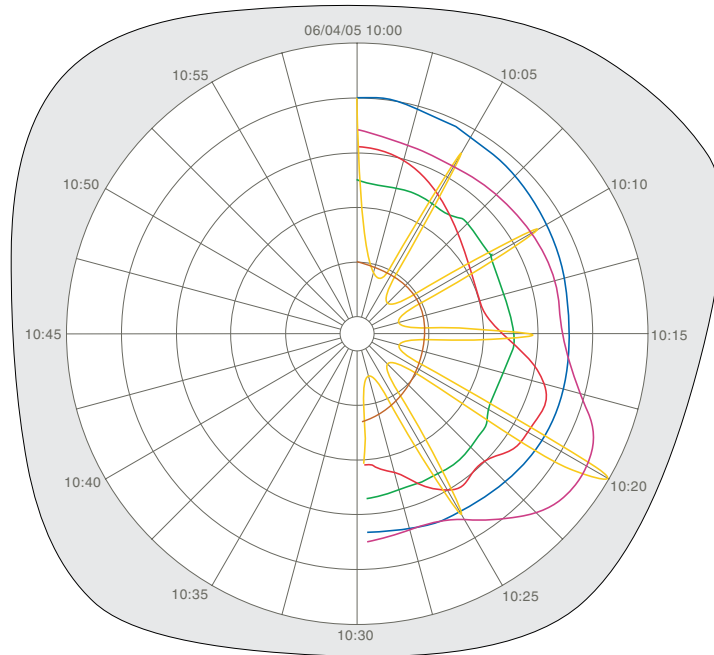

Figure 3.4.3a Circular trend - New chart mode

NORMAL VIEW

Normal view is available only for large frame recorders (also small frame recorders when viewed via Bridge software). As shown in figure 3.4.3b, below, this provides a view of the chart, together with scale, chart speed, message bar and navigation keys. The figure shows a view with faceplates selected on.

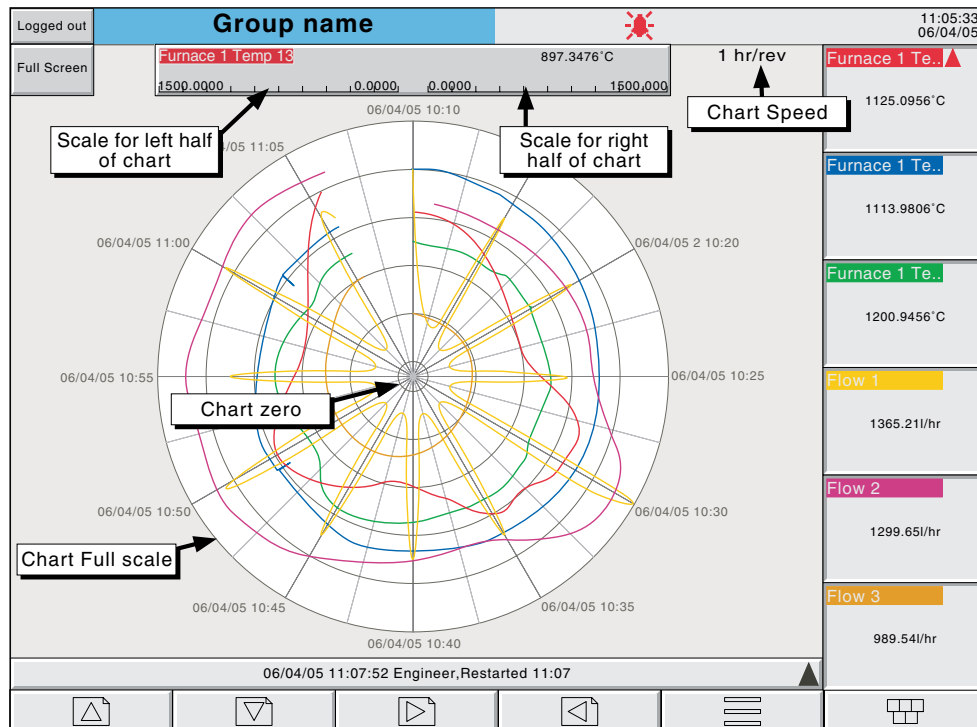

Figure 3.4.3b Circular Trend normal view (with faceplates)

3.4.3 CIRCULAR TREND (Cont.)

NORMAL VIEW FEATURES

- Scales** Two scales are provided, one for the left hand side of the chart, the other for the right hand side. Channel scaling is a part of channel configuration, as described in [section 4.3.3](#), below. The scales apply only to values along the horizontal line through the centre of the chart. Values for other angles (times) can be most easily found from the trace history, selected from the Option key, or by touching anywhere in the chart or in the green background area for a few seconds.
- Chart speed** This displays the currently selected speed of revolution of the chart. This speed is set up as a part of Group configuration ([section 4.3.2](#))
- Faceplates** Up to 12 faceplates can be displayed, giving point values and alarm indication.
- Message Bar** The message bar at the bottom of the screen displays the latest message. If an up arrow appears at the right hand end of the bar, there is more than one message. Touching the message bar calls a 'View Messages' window, detailing previous messages. See the description in [section 3.4.2](#) for more details.

FULL SCREEN DISPLAY

As shown in figure 3.4.3c, below, this maximizes the chart diameter, leaving only the chart, chart speed and faceplates (if selected on) on display. The figure shows a view with faceplates selected off. For the large frame recorder, faceplate on/off selection can be made only from one of the other display modes, as the navigation keys are not visible in this display mode.

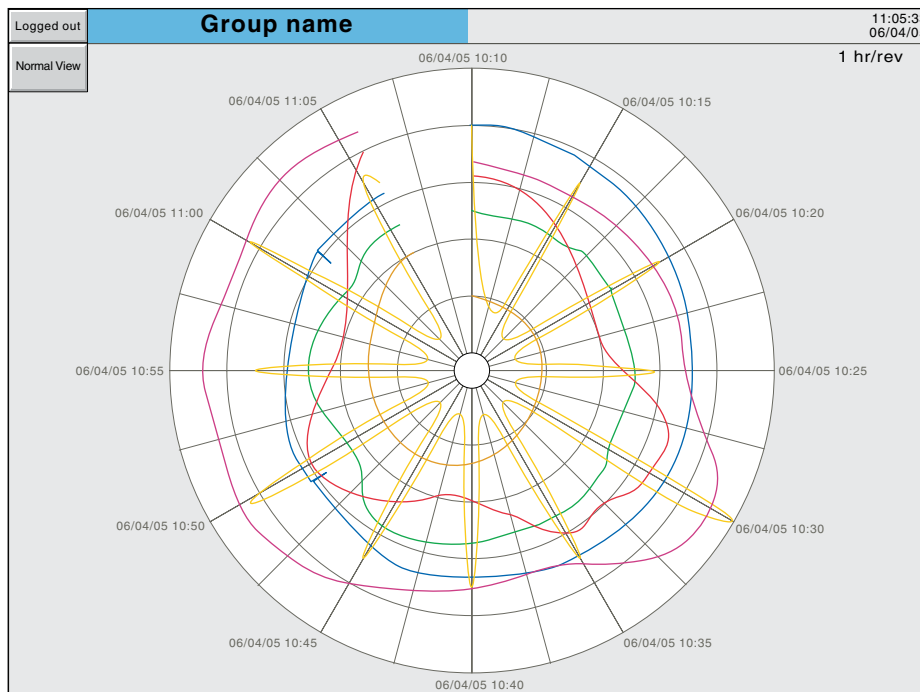

Figure 3.4.3c Circular Trend full screen view (with faceplates selected off)

FULL SCREEN FEATURES

- Faceplates** As described above for Normal View features

3.4.3 CIRCULAR TREND (Cont.)

TIMESTAMPS

Time and/or date are displayed at every major chart division. The following rules apply:

1. For chart durations of a week or more, only the date is displayed
2. For chart durations of less than a week, both time and date appear, with the following exception:

In 'New Chart' mode (unless the chart 'bridges' midnight), the date appears only at top centre of the chart. All other chart divisions are identified by time only.

OTHER NOTES

1. Adaptive recording results in two traces per trend, as in other trend display modes.
2. For successful circular trend display, 'Circular Settings' must be enabled for the relevant group ([section 4.3.2](#)), and 'Circular Trend' must be enabled for the group, in Views configuration ([section 4.3.4](#)). If Circular Trend is enabled, but Circular Settings is disabled, then, although the circular chart will appear, it is unlikely that it will contain any trends.
3. The circular chart speed is unaffected by A/B switching of Trend Speed/Interval ([section 4.3.2](#)).
4. Circular trends backfill only to the previous power up. Unless the parameter 'Circular Extended Backfill' has been enabled for the group in Group configuration ([section 4.3.2](#)), then circular trends will backfill multiple power cycles.

3.4 DISPLAY MODES (Cont.)

3.4.4 Vertical bargraph

Entered from [Circular Trend](#) mode by means of the down arrow key, or selected from the Root Menu 'Goto View' key, this display mode shows the Process Variable (PV) values as vertical bars with faceplates containing digital values and alarm data. There are two versions, one with faceplates above the bars (1 to 6 channels - figure 3.4.4a); the other (with faceplates at the right hand edge of the display - figure 3.4.4b) is used where there are more than six channels.

Note: The description above refers to the 180 mm version of the recorder. For the 100 mm version, the faceplates appear above the bars for one or two points, but to the right of the bars for three or more points.

Operation of the option key calls the Option menu display for this display page, allowing faceplates to be selected on or off. This feature is available for vertical trend, circular trend and vertical bargraph displays only.

To call the horizontal bargraph display mode, use the down arrow key. Alternatively, any one of the enabled display modes ([section 4.3.4](#)) can be selected using the Root Menu, 'Goto View' key.

Trend history mode is not available from this display mode.

FACEPLATES ABOVE THE BARS

See figure 3.4.4a.

As the number of channels in the display group increases, the bars and their faceplates get narrower,

FACEPLATES AT RIGHT-HAND EDGE

See figure 3.4.4b.

As the number of PVs increases, the bars get narrower. As the bars get narrower, so the scale values become truncated as shown in figure 3.4.4b. The bars have a set minimum width, and if the total number of points in the group cannot be displayed within the width of the screen, a horizontal scroll bar appears, allowing 'hidden' bars to be viewed. Similarly, the faceplates reduce in height to a minimum readable height. If there are more point faceplates than can be accommodated within the height of the screen, a vertical scroll bar appears, allowing hidden faceplates to be displayed as required.

3.4.4 VERTICAL BARGRAPH (Cont.)

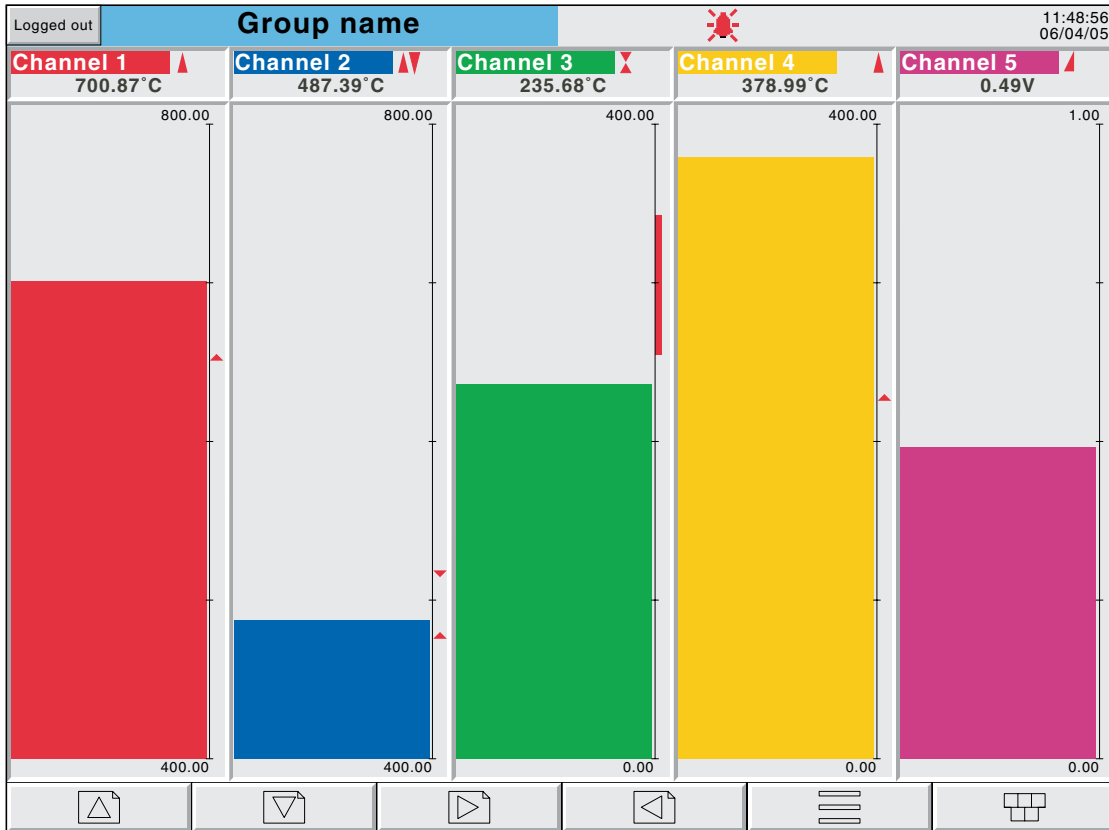

Figure 3.4.4a Vertical bargraph display (1 to 6 channels)

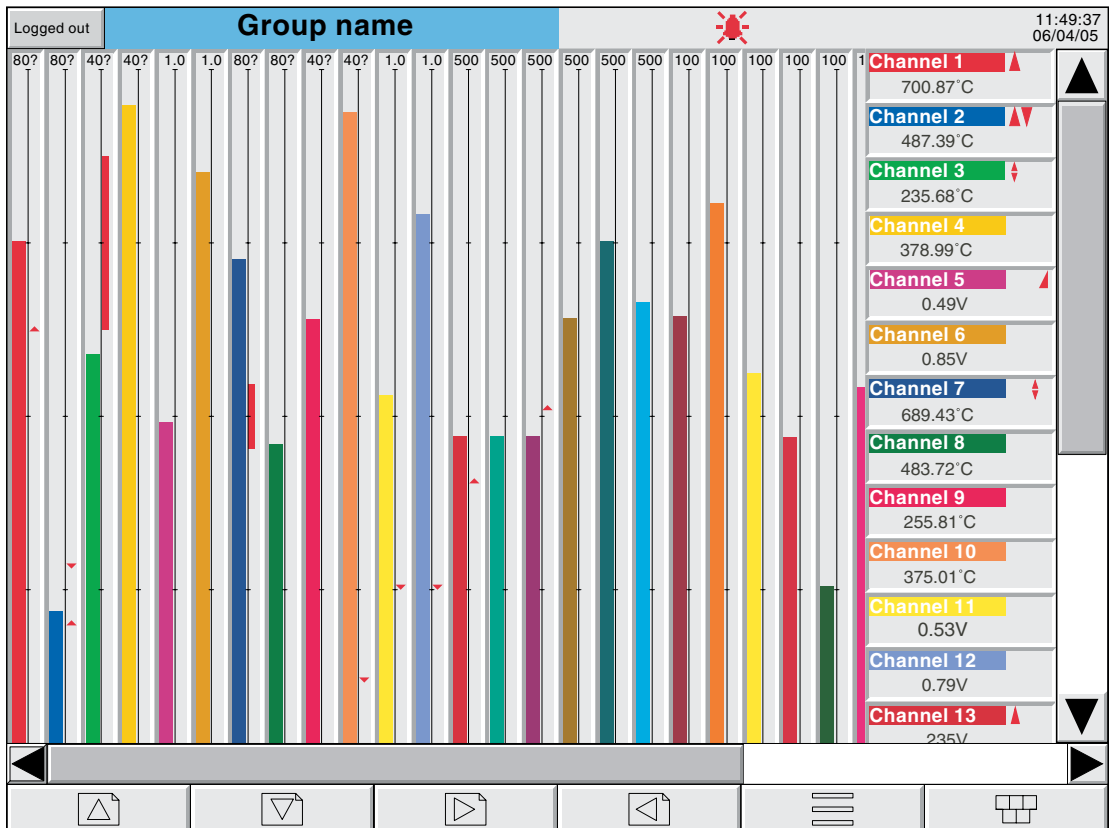

Figure 3.4.4b Vertical bargraph display (more than 6 channels)

3.4 DISPLAY MODES (Cont.)

3.4.5 Horizontal bargraph

Entered from [Vertical bargraph](#) by means of the down arrow key, or selected using the [Root Menu](#) 'Goto View' key, this display mode shows the Process Variable (PV) values as horizontal bars with digital values and alarm data displayed, as shown in figures 3.4.5a and 3.4.5b.

Notes:

1. For large frame recorders, single column format is used when there are up to 12 channels in the display group; double column for more than 12 channels. For small frame recorders, only the single column mode is employed, with a scroll bar when necessary.
 2. For large frame recorders, up to 26 points can be displayed simultaneously; for small frame recorders the maximum is 5 points. In either case, if more points are enabled than can be displayed within the height of the screen, a vertical scroll bar appears allowing currently hidden channels to be accessed.
-

Trend history mode is not available from this display mode.

To call [numeric display mode](#), use the down arrow key. Alternatively, any one of the enabled display modes ([section 4.3.4](#)) can be selected using the [Root Menu](#), 'Goto View' key.

3.4.5 HORIZONTAL BARGRAPH (Cont.)

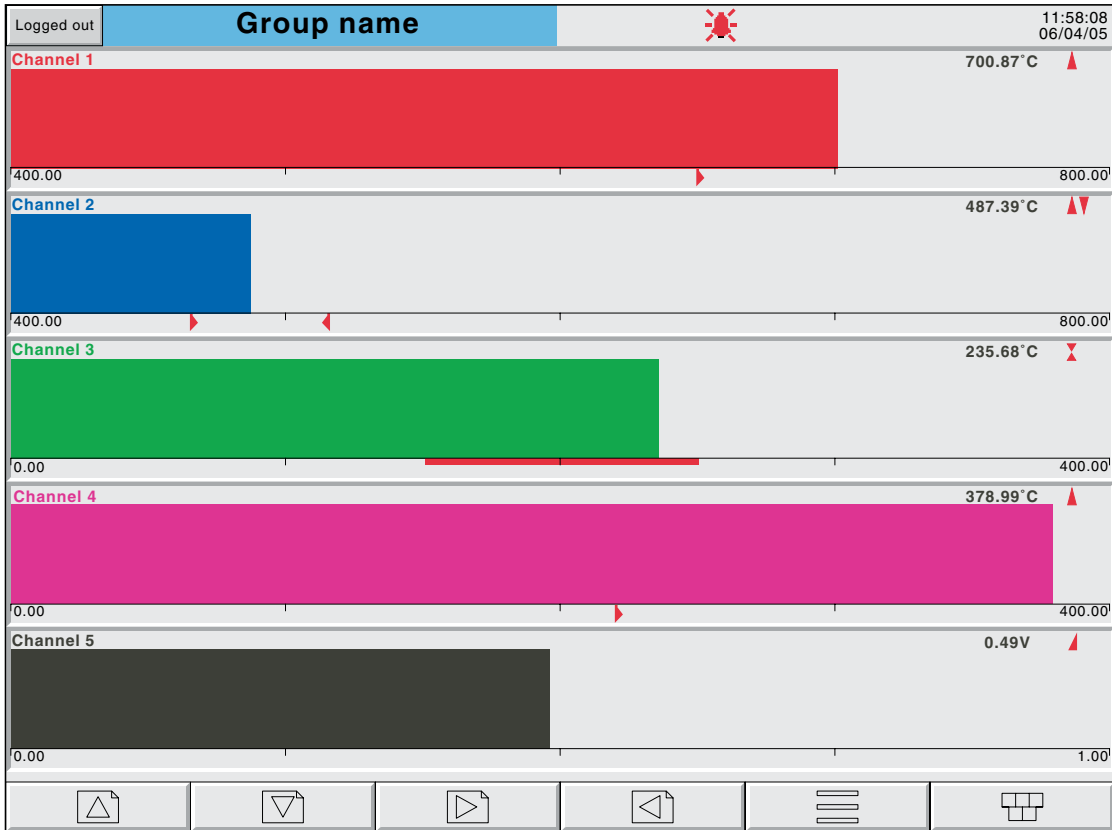

Figure 3.4.5a Horizontal bargraph display (single column example)

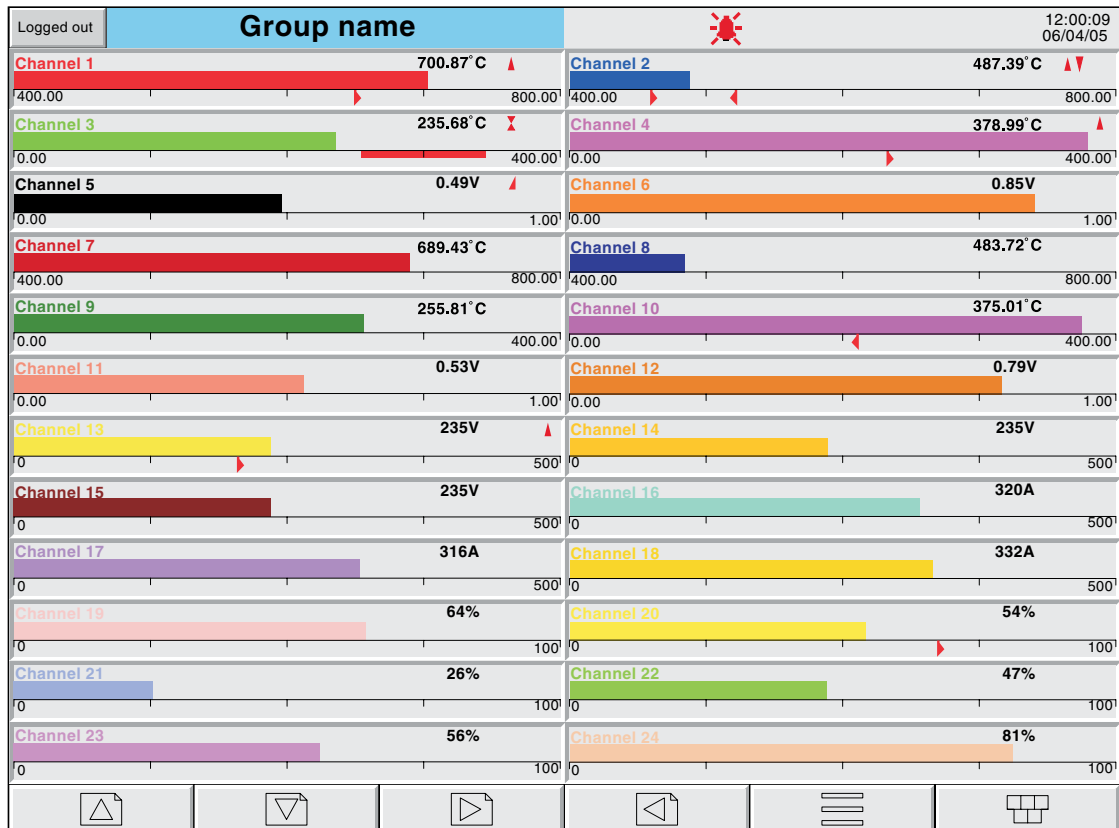

Figure 3.4.5b Horizontal bargraph display (dual column example)

3.4 DISPLAY MODES (Cont.)

3.4.6 Numeric

Entered from [Horizontal bargraph mode](#) by means of the down arrow key, or selected using the Root Menu 'Goto View' key, this display mode shows the Process Variable (PV) values as digital values. The format (which is automatically selected) is based on the number of channels in the display group. Figures 3.4.6a, 3.4.6b and 3.4.6c, show typical (large frame) examples of the one, two and three column versions of this display mode respectively. Within each version, the process variable display areas expand or contract to fill the screen.

Trend history mode is not available from this display mode.

A further operation of the down arrow key returns to [Vertical Trend Display mode](#) described in section 3.4.1 above, or if user screens are fitted and enabled, to the first user screen (section 7). Alternatively, any one of the enabled display modes ([section 4.3.4](#)) can be selected using the [Root Menu](#), 'Goto View' key.

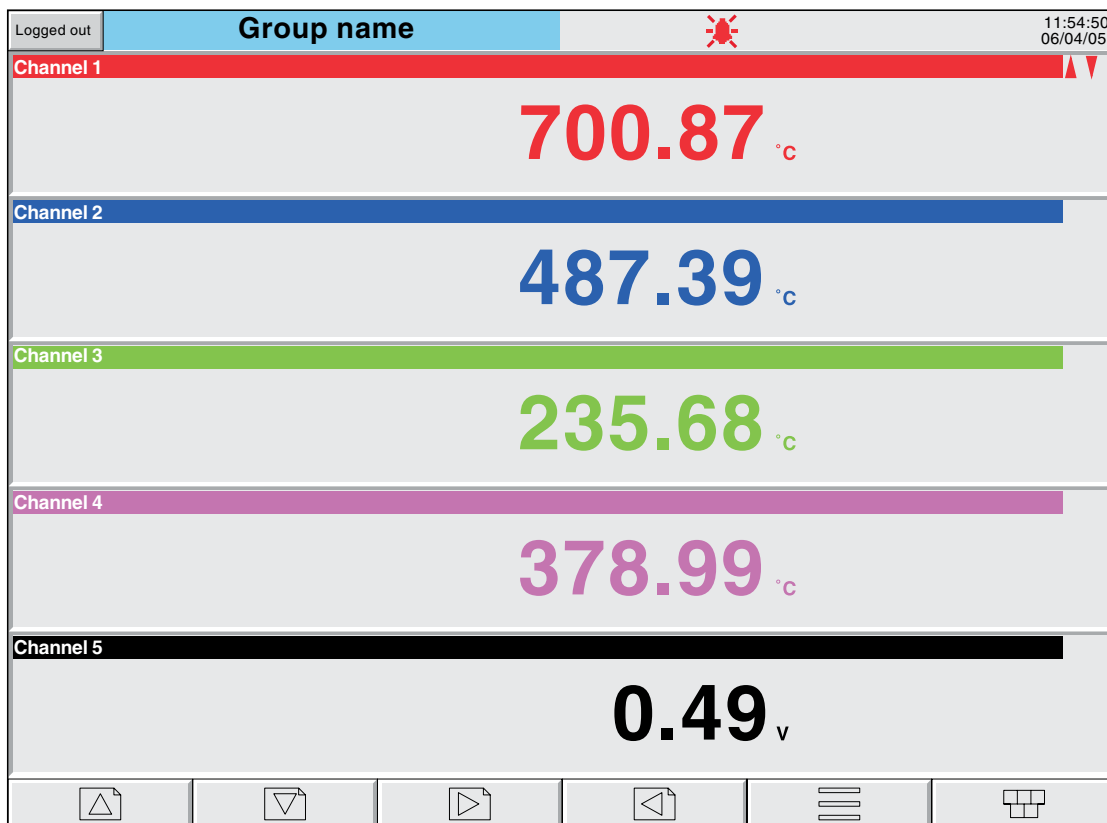

Figure 3.4.6a Numeric display mode (1 to 5 channels example)

Note: Figures 3.4.6a, b and c apply to the large frame instrument. For the small frame instrument, the single column display (figure 3.4.6a) is used for groups with up to four points enabled, and the two column display (figure 3.4.6b) is used, with scroll bar if necessary, for groups with more than four points. The small frame recorder does not employ a three-column mode (figure 3.4.6c).

3.4.6 NUMERIC DISPLAY MODES (Cont.)

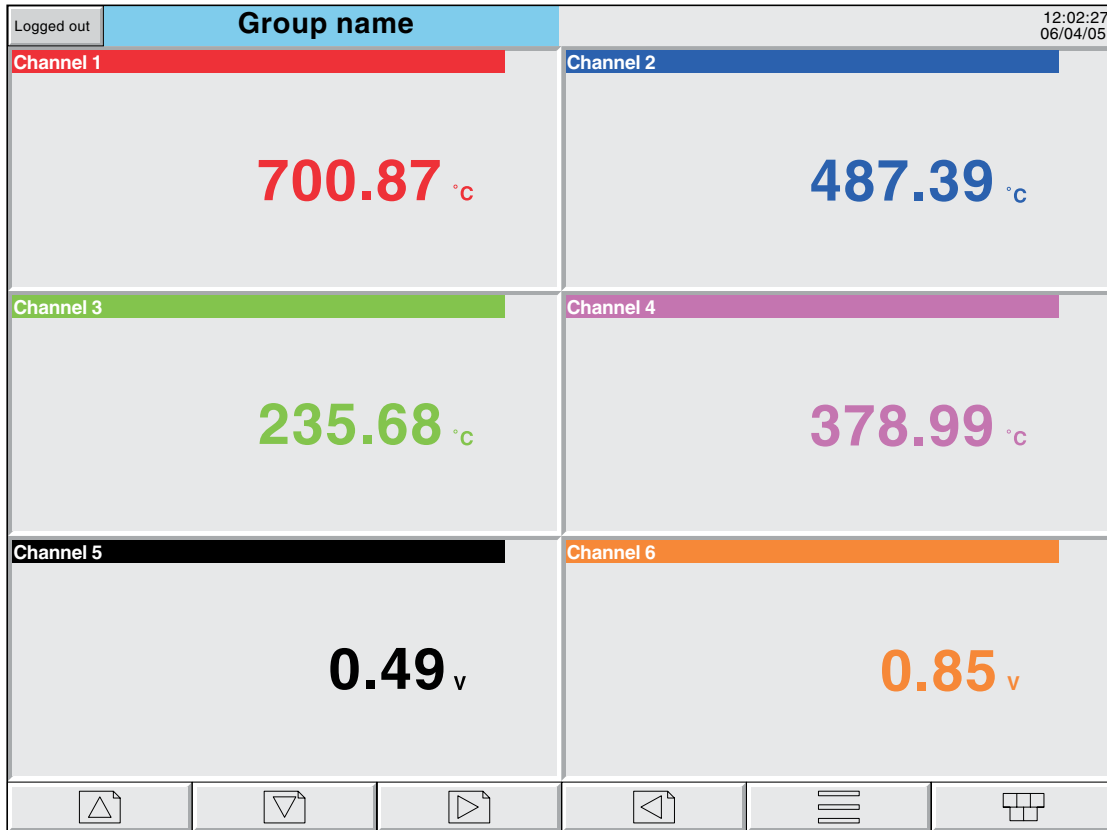

Figure 3.4.6b Numeric display mode example (6 channels)

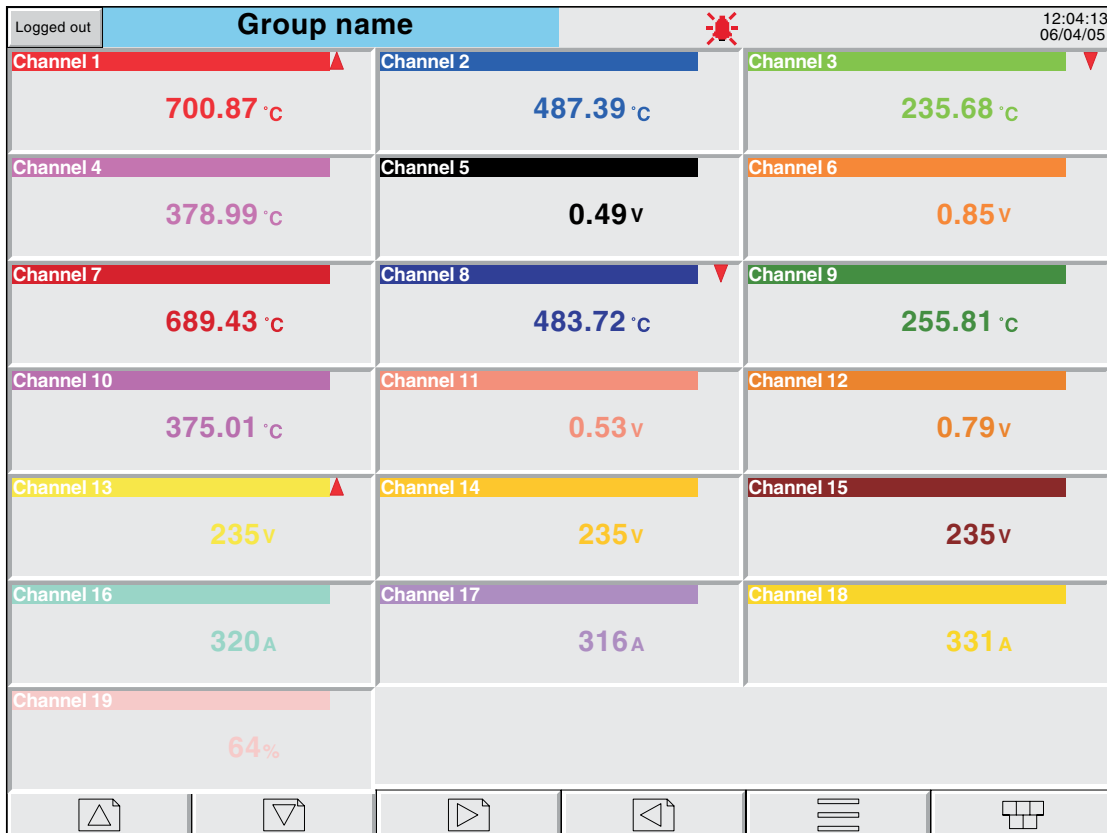

Figure 3.4.6c Numeric display mode example (19 channels)

3.5 OPERATOR NOTES

Note: Operator notes should not be confused with similar messages, (described in [section 4.3.8](#)), which appear as a result of job action.

It is possible for the user to enter a note, of up to 120 characters, at any time, from any display page (not from configuration pages). Each note is associated with the current display group and becomes a part of that group's history. The notes appear on vertical and horizontal trend displays only, although they can be entered in any display mode.

The note appears on the chart and in the Message Log, preceded by the date, time and current full user name, as shown in the first example below. If 'Audit Trail' is enabled, the note contains audit trail information, as shown in the second example below. See [section 4.4.2](#) for details of the Auditor options.

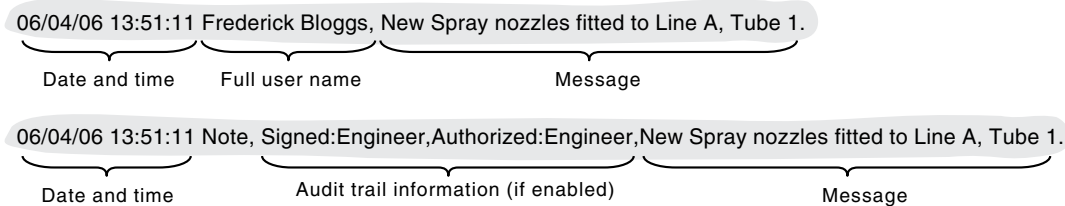

To enter a message:

1. Press the Option key, then the 'Note' key
2. If necessary enter Signature and Authorization passwords (Auditor 21CFR11 option only - see [section 4.4.2](#)).
3. Touch the note area of the resulting pop-up display (see note below).
4. Enter the required text of up to 120 characters (spaces are also counted as characters). Press Ok when finished.
5. View the note and
 - a. press the Ok button to enter the note OR
 - b. re-touch the text area to edit the note OR
 - c. press the Cancel key to quit note entry.

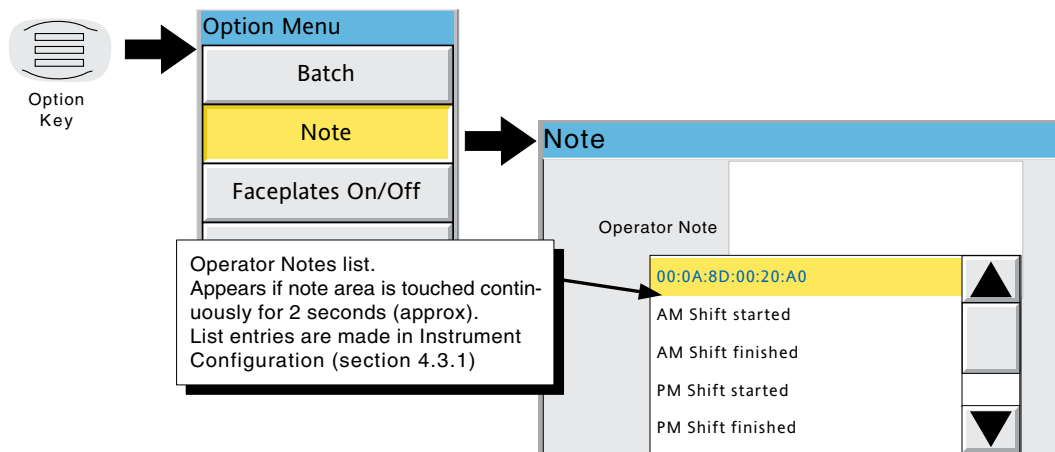

Figure 3.5 Access to Note entry page

Note: Touching the note area continuously for two seconds or more, causes a list of pre-defined messages to appear. Touching one of these messages selects it as the operator note, which can then be edited in the normal way (if required) before the OK key is operated. There are a maximum of 13 pre-defined messages, 12 of which are user editable in the Configuration/instrument menu ([section 4.3.1](#)), the 13th being the non-editable MAC address of the recorder.

4 SETTING UP THE RECORDER

As described in the 'Access to Configuration' ([section 3.3.2](#)) above, the setting-up of the recorder is divided into the following areas:

Archive	Section 4.1 - Allows manual archiving of data to a memory device or to a remote host (FTP transfer).
Save/restore	Section 4.2 - Allows new configurations to be created and saved, and saved configurations to be 'restored'. Save/Restore also allows the importing and exporting of User Linearisation Tables and, if the relevant options are fitted, User Screens and Printer Drivers.
Config	Section 4.3 - This is the major channel/alarm option etc. area of configuration.
Security	Section 4.4 - Allows passwords to be entered and edited and allows the Engineer-level password holder to enable/disable areas of configuration to Operator-level password holders. New users can be added, with their own user names, passwords and access level permissions.
Network	Section 4.5 - This area sets up the IP address/host names etc. used in FTP/(S)FTP transfer, Bridge and SNTP applications.
System	Section 4.6 - Allows <ol style="list-style-type: none">Time and date to be set (Clock).Language, date/time format, time zone, and daylight saving start and finish dates to be set (Locale).Software upgrades to be carried out (Upgrade).Input channels to be adjusted for errors in transducer inputs (Input Adjust).Output channels (if fitted) to be adjusted (Output Adjust - see section 9.4).A Master Comms Diagnostics page to be displayed (if Master Comms option fitted and enabled).A Network diagnostics page to be displayed (Ethernet diagnostics).Configuration items (e.g. input channels) to be copied, to speed up configuration (Copy).Search criteria to be entered to allow the user to locate trigger sources for a specific job (Job search).The appearance of the display screens to be customised (Customise).Details of the hardware and software associated with the recorder to be displayed (About).

Note: In all the following descriptions, if a change is made to a menu item, then the item text changes to red, until it is 'applied'

4.1 ARCHIVE

Notes:

1. The archiving functions described below can also be initiated by job action - see [section 4.7.15](#).
2. Archiving is carried out on a group by group basis, with a message being sent to each group when its archive is finished. When all the groups have been archived, a pop-up appears to inform the user that archiving is complete. Because of the sequential nature of this process, the time given in this pop-up is different from the times which appear in the messages generated for the individual groups.
3. For floppy disk drives (connected via a USB port), it is not recommended that archiving be enabled for more than one group (see 'Group' configuration - [section 4.3.2](#))

4.1.1 Local Archive

CAUTION

Removal of the memory device whilst archiving is in progress causes irreparable damage to the filing structure on the device, rendering it unusable. For this reason, archiving should be suspended before the device is removed. It is strongly recommended that the 'Remove Media' facility described in [section 3.1.4](#) (Summary menu) be used to ensure that it is safe to remove the memory device. For recorders fitted with a lockable flap, see also [section 2.4](#).

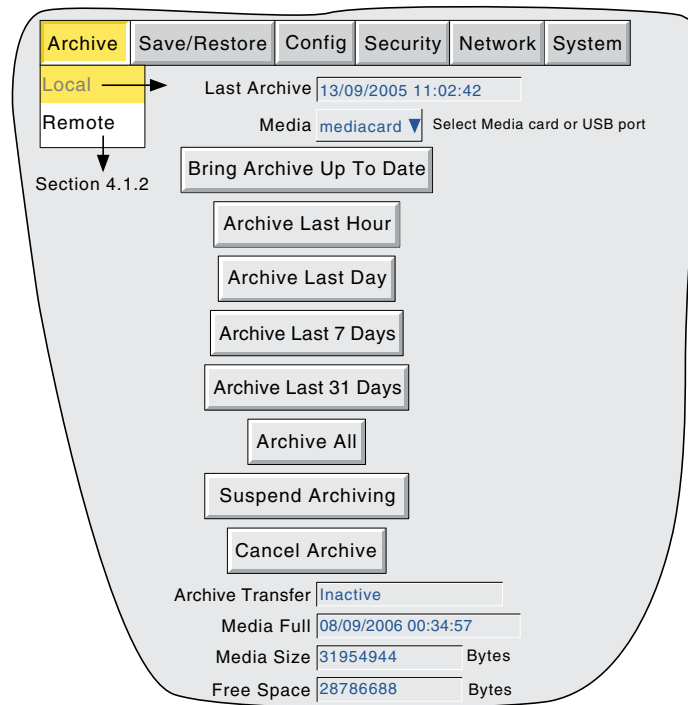

Figure 4.1.1 Local archive configuration

Local archive allows the user to initiate data transfer to the device defined in the 'Media' picklist for all groups with 'Archive to Media' enabled (Group configuration - [section 4.3.2](#)). Archiving is initiated by touching the relevant archive period key (e.g. Last Day'). The memory device can be selected as 'mediacard' (the integral Compact Flash or SD card), or a USB port can be selected if, for example, a memory stick is to be the destination device. USBfront is located behind the flap below the screen. If the option is fitted, USB 1 and USB 2 ports are located at the recorder rear panel.

Archiving starts as soon as the selection is made, and cannot be stopped until completed, unless the Cancel Archive key is operated, in which case the archive will be stopped after a confirmatory message has been responded to. The Cancel key is active only if 'Archiving Control' is enabled in Security/Access ([section 4.4](#)) for the current login.

4.1.1 LOCAL ARCHIVE (Cont.)

BRING ARCHIVE UP TO DATE

This causes the recorder to archive all history files created since the last manual or automatic ([section 4.3.5](#)) archive.

ARCHIVE ALL

This causes the recorder to archive all its history files.

If the memory device becomes full before archiving is complete, archiving pauses and a pop-up request appears, asking for a replacement. If this request is not responded to within 10 minutes of its appearance, archiving is aborted.

Unattended archiving can be paused by the user (e.g. to change media without losing data) by operating the 'Suspend Archiving' / 'Resume Archiving' button. Any archiving in progress is allowed to complete before the 'Suspend Archiving' request takes effect. Transfer activity is indicated in the 'Archive transfer' window.

Below the selection buttons are a number of status windows relating to the selected memory device. 'Media Full' is an estimate, based on the current configuration, of when the memory device will become full. The meanings of the 'Media Size' and 'Free Space' values are self evident.

If automatic archiving is active ([section 4.3.5](#)), then automatic and manual archives will operate on a first come-first served basis. Some files will be saved twice in such a circumstance, the later archive's files overwriting any earlier archive's files which have the same name.

ARCHIVING WITH THE LOCKABLE FLAP OPTION

For recorders fitted with the lockable flap ([section 2.4](#)) it should be noted that when the flap is opened, archiving is automatically suspended. It is therefore necessary to press on the 'Resume Archiving' key before any attempt is made to carry out a demand archive.

Before removing the memory device, archiving should be suspended again, using the 'Suspend Archive' key. This ensures that the memory device can be safely removed.

4.1.2 Remote archiving

FILE TRANSFER PROTOCOL

This allows archiving of recorder files, for all groups with 'Archive via FTP' enabled, to a remote computer, connected (using the RJ45 telephone type connector at the rear of the recorder) either directly, or via a network. 'Archive via FTP' is enabled/disabled as part of Group configuration - [section 4.3.2](#). In order to carry out a successful transfer, details of the remote host must be entered in the Archive section of the 'Config' menu ([section 4.3.5](#)).

Note: An FTP server must be running on the remote host.

Figure 4.1.2 shows the menu for remote archiving. The Archive last hour/day etc. keys allow the user to determine which files are to be archived. Selection of 'Bring Archive Up To Date' causes the recorder to select whichever of the Last Hour/Last Day etc. categories is appropriate in order to bring the archive up to date. The 'Last Archive' window shows the time and date of the previous archive. The Archive Transfer window shows archive status as 'Active' or 'Inactive'.

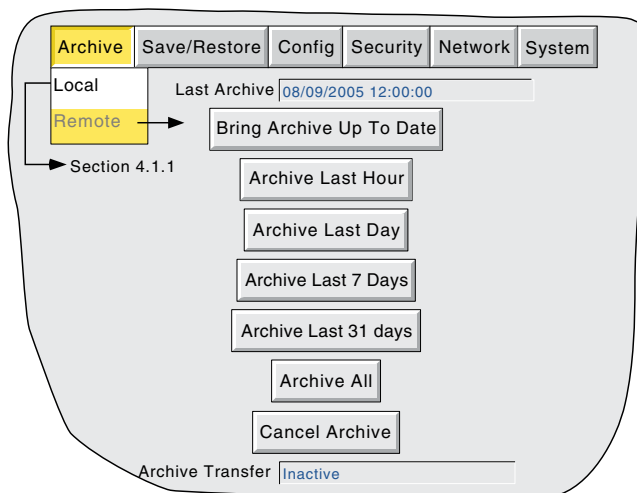

Figure 4.1.2 Remote archive strategy configuration

Additionally, a user on a remote PC has full viewing capabilities, can extract recorder files at any time, and can access those items of recorder configuration that are associated with the user's login. For successful connection, 'Connect from Remote' must be enabled and the 'Remote user name' and 'Remote password' must be defined in one of the accounts (all in the Security access menu ([section 4.4.1](#))).

Notes:

1. In order to view history files when accessing the instrument remotely, the recorder's address, the 'Remote user name' and the 'Remote password' must be supplied to an FTP client such as PC Review or Microsoft® Internet Explorer.
2. When accessing files using Microsoft® Internet Explorer, the address (URL) field can be in one of two forms:
 - a ftp://<instrument IP address>. This allows the user to log in as the anonymous user (if the instrument has any account with 'Remote user name' set to 'Anonymous' and a blank password).
 - b ftp://<user name>:<password>@<instrument IP address> to log in as a specific user.
3. For IE5 users only: Microsoft® Internet Explorer displays, by default, history files only. To exit the history folder, either uncheck the Tools/Internet Options/Advanced/Browsing/"Enable folder view for FTP sites" option, or check the Tools/Internet Options/Advanced/Browsing/"Use Web based FTP" option.

SECURE FILE TRANSFER PROTOCOL (SFTP)

For further details, see [Section 4.8 Secure File Transfer Protocol \(SFTP\)](#) on page 247.

4.2 SAVE / RESTORE

As shown in figure 4.2a, touching the 'Save/Restore' key calls the picklist: Save, Restore, New, Text, Import/Export Screen, Import/Export User Linearisation, Import Printer Driver. Import/Export Screen choices appear only if the User screens option is fitted.

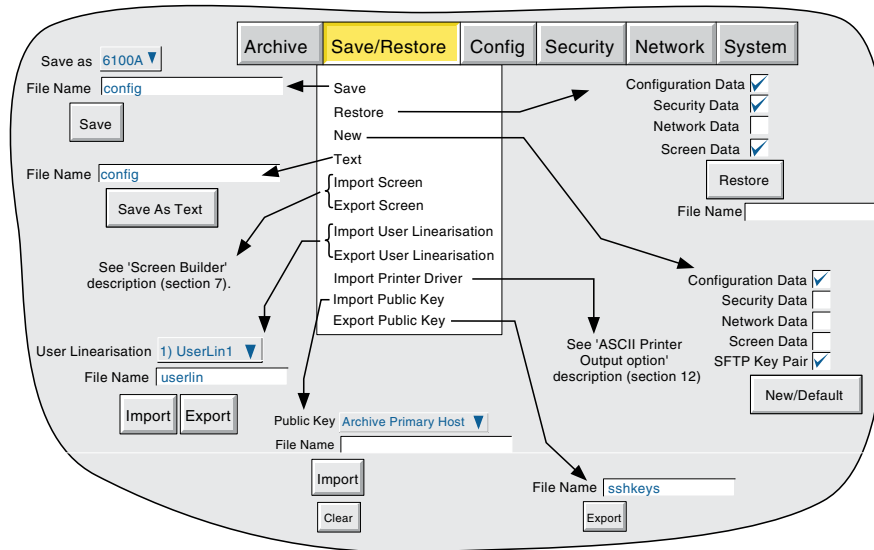

Figure 4.2a Save/Restore menu

Where a file name is required, then, if the displayed file name is suitable, operation of the 'Save', 'Restore', 'Import' or 'Export' key will initiate the action. If, instead, a file name has to be entered, this is carried out as follows:

Touching the filename window causes a pop-up menu to appear, giving a list of 'Volumes' in the Flash memory or on the memory device (if inserted). Figure 4.2b shows an imaginary Volume contents list, displayed by touching the name 'user', then operating the down arrow or 'open folder' key. (See section 5, below for more details). Once the correct folder is open, either select an existing file, or enter a new filename, by touching the FileName window and entering the name using the pop-up keyboard(s) as described in section 3.3.2 "TEXT STRING ENTRY". Operation of the Save/Restore key initiates the action.

\\user\			
Name	Type	Date	Bytes
cal\	Folder	03/04/05 12:35:08	
config\	Folder	01/04/05 10:27:13	
Filter1a	Config	05/03/05 10:22:23	4445
lib\	Folder	05/03/05 10:23:14	
sdb\	Folder	11/02/05 14:01:08	
user\	Folder	06/04/05 15:41:30	

FileName: Filter1b

Figure 4.2b Typical volume contents page

4.2.1 Save

Touching this item allows the current configuration to be saved in the recorder's memory. Files saved in this way are not in a 'readable' format and are used only for archive /security purposes or for transfer to another, similar, recorder.

SAVE AS

This selection box allows a configuration to be saved, if required, in a format suitable for importing into previous recorder models. The default is always the current instrument.

4.2.2 Restore

Touching this item allows the user to select or type-in a previously saved configuration file name, which will then be used as the current configuration. Touching the 'Restore' key completes the operation. Check boxes allow one or more of Configuration Data, Security data (note 3), Network data and Screen data to be chosen for the restore function.

Notes:

- 1 Screen data restores faceplate status for vertical trend and vertical bargraph modes, and user screen information (if the option is fitted).
 2. If archiving is in progress when a 'Restore' is requested, the Restore operation will be delayed until the archive is complete (maybe several minutes). If required, the 'Cancel Archive' key ([section 4.1](#) above) can be used to speed up the Restore process, at the cost of losing the archive data.
 3. If 'Centralised Security' is active (part of Security/Management configuration - [section 4.4.2](#)) 'Security Data' is not selectable (either for 'Restore' or for 'New' (below)).
 4. If the file to be restored has been created using 'C-Edit' software, each of the characters used in the file name must lie within the unicode range 0 to 255, or the file name might not be displayed correctly.
-

4.2.3 New

Touching this item causes the factory entered default configuration to be loaded for use, or for editing. Operation of the New/Default key completes the operation. Tick boxes allow one or more of Configuration Data, Security data (note 3 above) and Network data to be chosen for the restore default function; only those items which are ticked are replaced by default values.

For recorders with the User Screens option ([section 7](#)), a further tick box is displayed - 'Screen Data'.

The option *SFTP Key Pair* appears (from version 5.8) under the Save/Restore > New menu. To generate new Secure FTP keys, both the private and public keys that will replace the existing versions, see [SFTP Key Pair - Generate on page 56](#).

SFTP KEY PAIR - GENERATE

1. Select Save/Restore > New, the Save/Restore menu displays, see [Figure 4.2a Save/Restore menu on page 55](#).
2. Select and check the SFTP Key Pair checkbox (and tick will appear).
3. Click the New/Default button.

Note: When generating new SFTP keys beware the previous will be replaced, rendering any existing SFTP configurations out of date and non servicable.

For further information see [4.8 Secure File Transfer Protocol \(SFTP\) on page 245](#)

4.2.5 Import screen

This field appears only if the User Screens option ([section 7](#)) is fitted, and allows a previously exported User Screen file to be imported.

4.2.6 Export screen

This field appears only if the User Screens option ([section 7](#)) is fitted, and allows a User Screen to be exported to a removable memory device or to the internal Flash memory. The exported screen can subsequently be imported either into this recorder or into a different recorder.

4.2.7 Import User Linearisation

The Import Linearisation feature allows linearisation tables to be imported either from the Compact Flash/SD card, USB device or if Bridge 'Full' software is fitted, directly from the host PC.

Touching the User Linearisation field allows the user to select which of 'UserLin1' to 'UserLin4' is to contain the imported file.

Touching the File Name field, calls a popup menu similar to that shown in figure 4.2b. This allows the user to select the table to be imported.

The file must be comma separated ASCII as follows:

```
n,  
X1,Y1  
X2,Y2  
X3,Y3  
.  
.  
Xn,Yn
```

where 'n' is the total number of XY pairs in the table, and for each pair, X is the input value, and Y is the linearised value corresponding to X. See [section 4.3.9](#) for full details.

Note: Imported linearisation tables will not become effective until after the next configuration 'Apply' operation.

4.2.8 Export User Linearisation

Similar to 'Import user Linearisation', above, the Export Linearisation feature allows linearisation tables created in the recorder to be exported either via the Compact Flash/SD card or if Bridge 'Full' software is fitted, directly to the host PC. See [section 4.3.9](#) for full details.

4.2.9 Import printer driver

Similar to 'Import user Linearisation', above, this allows driver (.uhi) files for new printer types to be imported either via the Compact Flash/SD card, or USB memory stick, or if the Bridge 'Full' option is fitted, directly from the host PC. See [section 12](#) for further details.

Note: Imported printer drivers do not become effective until after the next configuration 'Apply' operation.

4.2.10 Import Public Key

The Import Public Key menu enables the user to import a Public key from other secure FTP applications that need to connect, communicate and transfer files securely using Secure FTP, either via the Compact Flash/SD card or USB memory stick.

SECURE FTP (SFTP) PUBLIC KEY - IMPORT

1. Ensure the Compact Flash/SD card or USB memory stick used to transport the SFTP Public key(s) is inserted.
2. Click the *Save/Restore* key, then select *Import Public Key* from the drop down menu. (For further information on the menu see [Figure 4.2a Save/Restore menu on page 55](#)).

The Import Public Key page appears.

3. From the *Public Key* drop down menu, select the relevant Public key type that matches where the supplied public key was generated, from a choice of;
 - Archive Primary Host
 - Archive Secondary Host
 - Upgrade Host

*Note: It helps when importing SFTP Public keys to generate and apply a relevant name to each Public key i.e. *ArcServer1pubkey* or *ArcServer2pubkey*, then at import stage the user can differentiate and allocate using the Public keys file name.*

Archive Primary Host

A configuration using one 'archive' server that requires one SFTP Public key to be imported.

4. Select and set in the Public key drop down menu to: *Archive Primary Host*.
5. Pick and enter into the *File Name* text box, the file browser page displays.
6. Navigate to and select one of the below folders listed below that contains the relevant SFTP Public key to import. (Use the page controls, see Folder Up or Down icons):
 - "\\mediacard\" directory (compact flash memory (SD card))
 - "\\usbfront\" directory, (USB memory drive - only appears when a USB memory drive is inserted)
7. With the relevant directory selected and highlighted, click the folder down arrow button to enter folder structure.
8. Locate and select the Public key. (Use both the file *Name* and *Type (pub)* to locate the public key).

The selected Public key will:

- Be highlighted in the file list to acknowledge the selection
 - Load in *Filename:* text box
9. Click *Open* to load.

*Note: Click *Cancel* to abort the import process. The display will return to Import Public Key page.*

10. Select *Ok* to acknowledge and confirm the Public key import.

Once the Public key finishes being imported the display returns to the *Import Public key* start page.

The page displays a summary of the import settings:

- Public Key *Archive Primary Host*
- File Name *ArcServer1pubkey*
- *Import* button
- *Clear* button

The Public key *ArcServer1pubkey*, generated and supplied from "Archive server 1" has been imported and allocated to the instruments *Archive Primary Host*.

Note: Do not click *Import* or *Clear* to complete and dismiss the Public Key Import process.

11. To close the Public Key Import, select *Root Menu* button. (See [ROOT MENU KEYS](#) on page 28).

The *Root Menu* panel appears.

12. Select *Home* to return to the home page.

Archive Secondary Host (Secondary archive server)

Configurations running remote archiving (see [4.1.2 Remote archiving](#) on page 54), using two servers - the primary and secondary, to provide redundancy - will need to generate separate SFTP Public keys per server and transfer a copy of each public key to be imported into the instrument.

1. Repeat steps 4 to 10 of the [Secure FTP \(SFTP\) Public Key - Import](#) to import the second, different SFTP Public key
2. Update the following settings:
 - Step 4 - set the *Public key* drop down menu to: *Archive Secondary Host*
 - Step 8 - substitute the SFTP Public key for the secondary archive servers' SFTP Public key

When imported the *Import Public key* page displays a summary of the import details:

- Public Key *Archive Secondary Host*
- File Name *ArcServer2pubkey*
- *Import* button
- *Clear* button

The Public key *ArcServer2pubkey*, generated and supplied from an external server i.e. "Archive server 2" has been imported and allocated to the instruments *Archive Secondary Host*.

Note: Do not click *Clear* to complete and dismiss the Public Key Import process.

3. To finish the Public Key Import, select *Root Menu* button. (See [ROOT MENU KEYS](#) on page 28).
4. The *Root Menu* panel appears
5. Select *Home* to complete the process.

Upgrade Host (Firmware update server)

Configurations utilizing an upgrade server, see [Section 4.6.3 Upgrade on page 227](#) - will need to generate a separate SFTP Public key, transfer and import a copy of the public key.

1. Repeat previous steps 4 to 10 to import the SFTP Public key
2. Update the following settings:
 - Step 4 - set the *Public key* drop down menu to: *Upgrade Host*
 - Step 8 - substitute the SFTP Public key for the upgrade servers SFTP Public key

When imported the *Import Public key* page displays a summary of the import details:

- Public Key *Upgrade Host*
- File Name *UpgradeS1pubkey*
- *Import* button
- *Clear* button

The Public key *Upgradepubkey*, generated and supplied from the server i.e. "UpgradeServer1" has been imported and allocated to the instruments *Upgrade Host* setting.

Note: Do not click *Clear* to complete and dismiss the Public Key Import process.

3. To finish the Public Key Import, select *Root Menu* button. (See [ROOT MENU KEYS on page 28](#)).

The *Root Menu* panel appears

4. Select *Home* to complete the process.

For further information see:

[Section 4.8 Secure File Transfer Protocol \(SFTP\) on page 245.](#)

4.2.11 Export Public Key

The Export Public Key menu provides a method to export the generated SFTP Public key via the Compact Flash/SD card.

SFTP PUBLIC KEY - EXPORT

1. Click the Save/Restore key, then select *Export Public Key* from the drop down menu. (For further information on the menu see [4.2 SAVE / RESTORE on page 55](#)).
2. The Export Public Key panel appears, with the default file name: *sshkeys*.
3. Adjust the file name where necessary, then navigate using the panels control to either:
 - “\mediacard\” directory, to store on the compact flash memory
 - “\usbfront\” directory, for the USB memory drive - which only appears when a USB memory drive is inserted)
4. Ensure you enter the folder structure by one level, using the folder down arrow button.
5. Click Save.

This saves a copy of the recorders SFTP Public key to the folder and in turn to the memory device selected in steps 3 and 4.

Note: Clicking *Cancel* will abort the Public Key export process and return you to Export Public Key front panel.

The SFTP Public key can be transferred manually and shared with other Secure FTP applications using the selected USB memory device.

For further information see:

[Section 4.8 Secure File Transfer Protocol \(SFTP\) on page 245.](#)

4.3 CONFIG KEY

Touching this key calls the top level configuration pick list:

Instrument,	User Linearisations,	Master Comms,
Groups,	Batch,	Output Channels,
Channels,	Maths,	Demand Writes,
Views,	Totalisers,	Emails,
Archive,	Counters,	Reports,
Events,	Timers,	EtherNet/IP Server
Event Buttons,	Connections,	Options
Messages,		

Notes:

1. Figure 4.3b gives an overview of the configuration menus.
 2. If an option is not fitted, it does not appear in the above list.
-

When making changes to the configuration the name of each changed parameter is displayed in red (instead of the normal black) until the 'Apply/Discard' key has been operated. For example, in channel configuration, if a thermocouple were to be changed from Type J to Type K, 'Lin Type' would appear in red, until the Apply key is operated.

Should an attempt be made to leave configuration with unsaved changes, a warning message appears, allowing the user to apply the changes, to discard the changes or to return to configuration (Cancel).

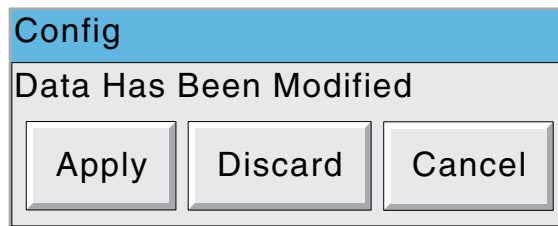

4.3 CONFIG KEY (Cont.)



Figure 4.3.b Configuration menu overview sheet 1

4.3 CONFIG KEY (Cont.)

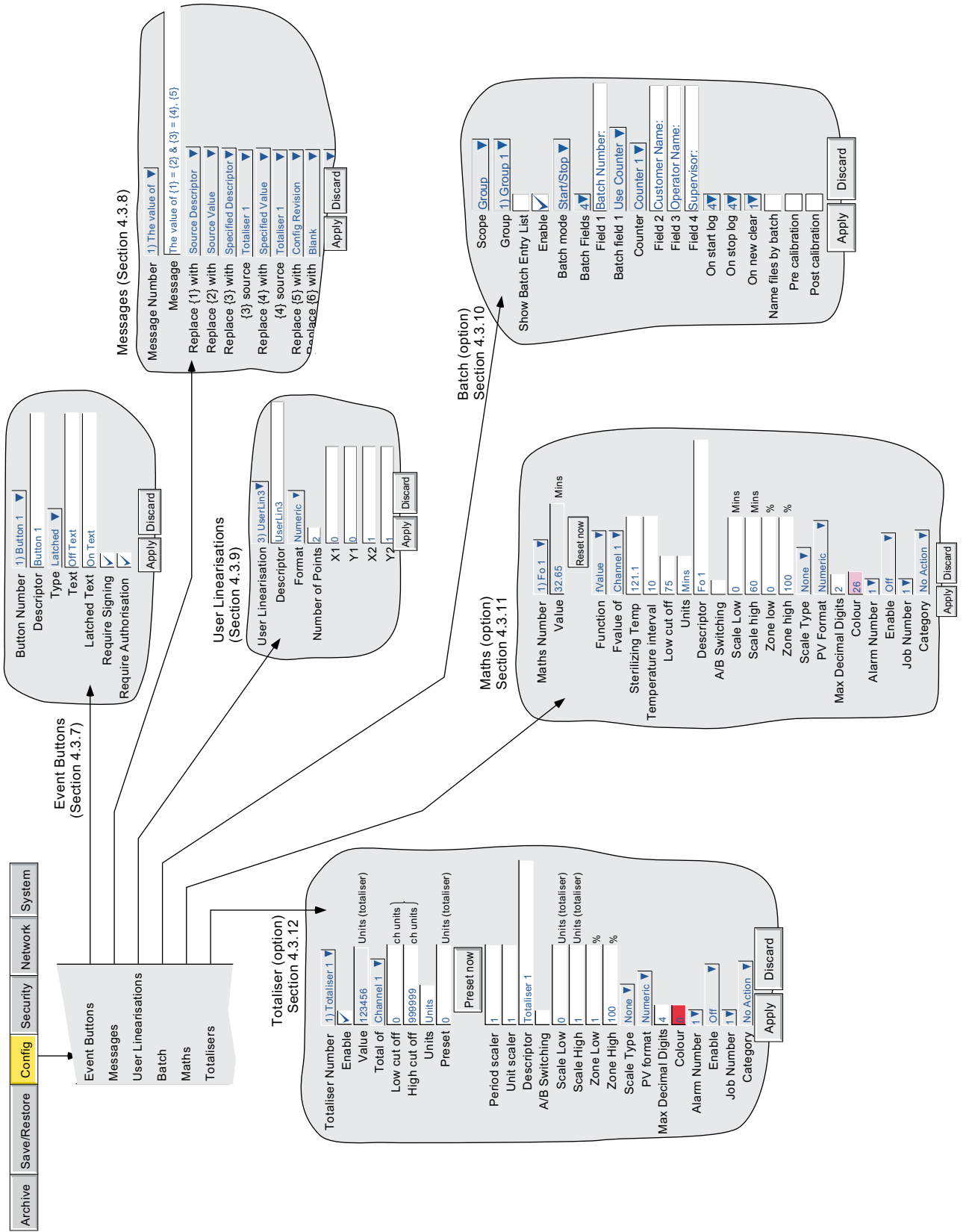

Figure 4.3b Configuration menu overview sheet 2

4.3 CONFIG KEY (Cont.)

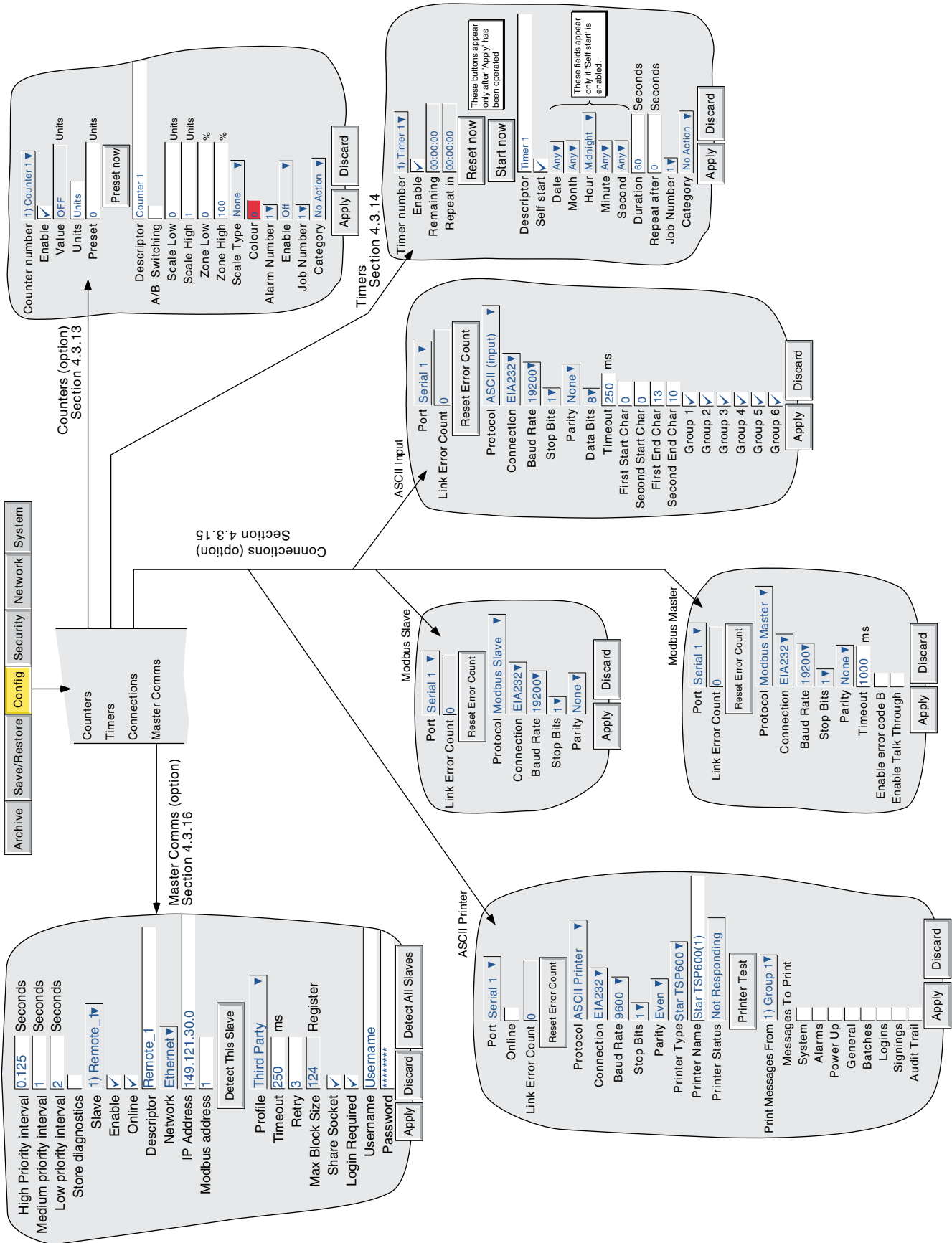

Figure 4.3b Configuration menu overview sheet 3

4.3 CONFIG KEY (Cont.)

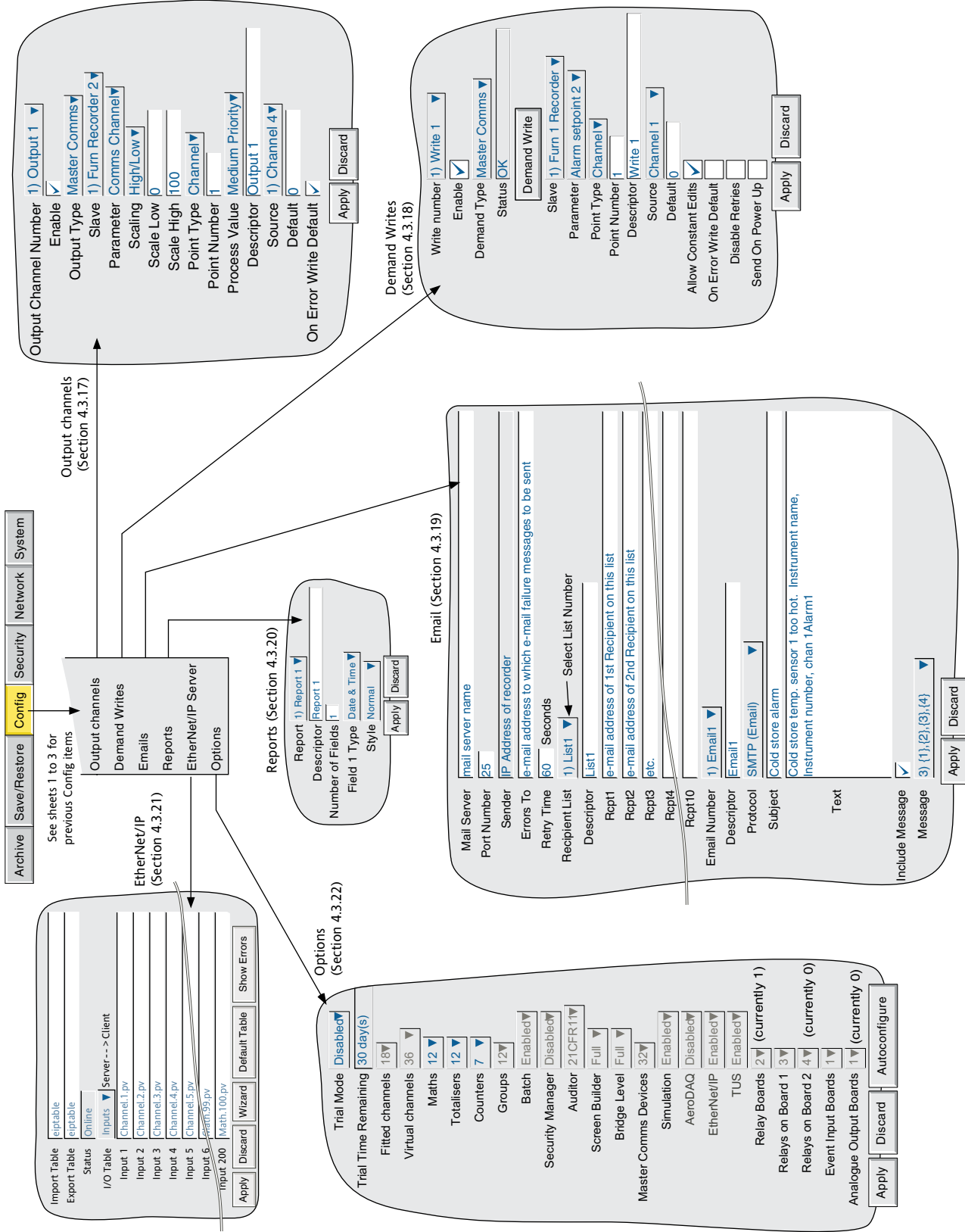

Figure 4.3b Configuration menu overview sheet 4

4.3.1 Instrument configuration

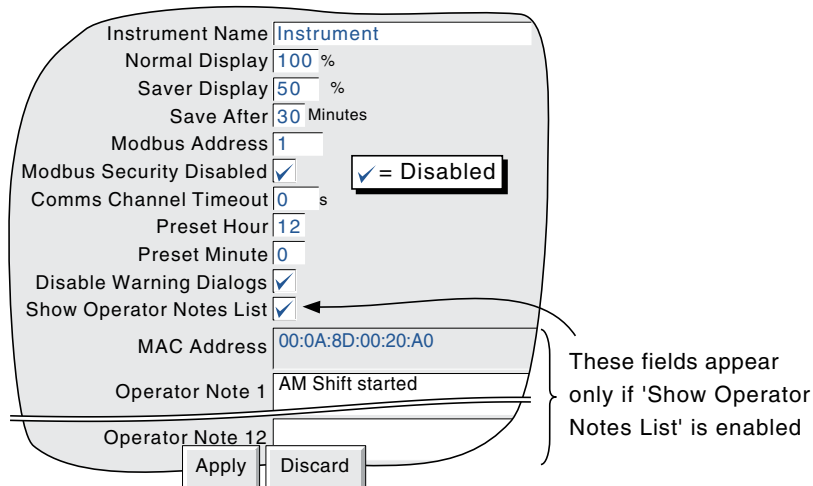

Figure 4.3.1 Instrument Configuration menu

INSTRUMENT NAME

Allows the entry of an alphanumeric name for the recorder, up to 20 characters long. See [section 3.3.2](#) for text entry techniques.

NORMAL/SAVER DISPLAY

Allows 'normal' and 'saver' display brightnesses to be defined. Defaults are Normal = 100%; Saver = 50%

SAVE AFTER

The number of minutes (between 1 and 99 inclusive), which are to elapse after a screen operation, before the screen brightness changes from 'normal' to 'saver'. Default is 30 minutes.

MODBUS ADDRESS

Allows a Modbus address between 1 and 247 to be set up, for use when the instrument is acting as a Modbus slave.

MODBUS SECURITY DISABLED

When using MODBUS, it is possible, by 'checking' this field to allow a host computer to access the recorder without its first having to supply a valid User name and Password. This box must be checked if this unit is acting as a Modbus slave in order for the unit to be detected. Once communications have been established, Modbus security can be enabled, providing that the Slave's Remote user name and password have been entered at the Master. See also [section 8.2.4](#).

COMMS CHANNEL TIMEOUT

Allows a number of seconds (between 1 and 999) to be entered. If none of the channels set to 'Comms' is communicated with, within this period, an event source (Comms channel timeout) is set, and remains set until the next communication. An entry of 0 disables the time out.

4.3.1 INSTRUMENT CONFIGURATION (Cont.)

PRESET HOUR

Enter an hours number between 0 and 23 for use with [Clock Job](#) - Preset clock.

PRESET MINUTE

Enter a minutes number between 0 and 59 for use with [Clock Job](#) - Preset clock.

Note: See [section 4.7](#) for a description of recorder jobs, and [section 4.5.1](#) for further details of time synchronisation.

DISABLE WARNING DIALOGS

Checking this box prevents instrument alarm messages from appearing on the screen.

SHOW OPERATOR NOTES LIST

Enabling this field produces a list of 13 entries which can be used in Operator Notes. The first entry is the MAC address of the recorder and is not editable. The remaining 12 entries (of up to 60 characters each) are freely editable.

Any one of these predefined notes can be selected (as described in [section 3.5](#)) by touching the Operator Note area continuously for two seconds, then touching the required note from the picklist which appears. Once selected the predefined note can be edited before use, like a normal Operator Note. Such editing does not affect the original note entered here in Instrument Configuration.

4.3.2 Group configuration

Note: Groups 1 to 6 is a standard recorder feature. The supply of groups seven to twelve is an optional extra.

Group configuration allows the user to define the following:

- a Group trend speed/interval
- b Group recording speed/interval
- c Group descriptor
- d Group content
- e Circular Trend speed and chart-full operation
- f Chart grid divisions

The production of alarm messages and the saving of group data to Flash memory, to removable memory device and/or to remote computer (FTP/(S)FTP transfer) can also be enabled / disabled from this menu.

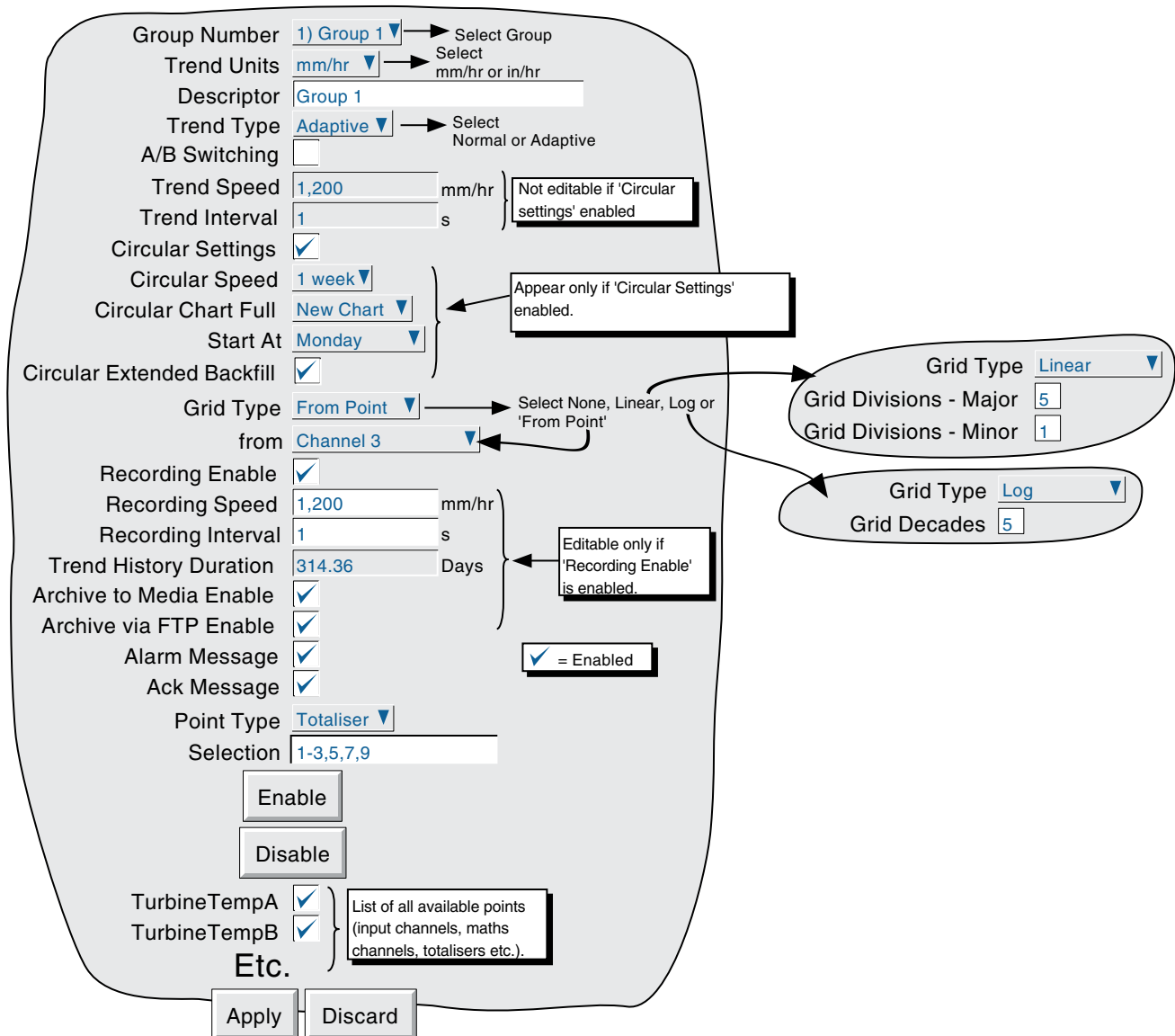

Figure 4.3.2a Group configuration menu

4.3.2 GROUP CONFIGURATION (Cont.)

GROUP NUMBER

Allows a particular group to be selected for configuration.

TREND UNITS

Allows mm/hr or inches per hour to be selected for the 'chart' speed. Automatically converts the trend speed field below.

DESCRIPTOR

Allows the group name to be edited. See [section 3.3.2](#) for text entry techniques.

TREND TYPE

This allows the selection of Adaptive Recording for vertical and horizontal trend modes. The purpose of adaptive recording is to ensure that rapid, short duration spikes (for example), are represented on the 'chart' even at low trend speeds. This allows the user to extend the total amount of history stored in the recorder (by using slow trend speeds) without losing transient data.

The adaptive recording method works by measuring the input signal at the normal 125 msec period, and saving the maximum and minimum values, continuously, over the period of trend update. When the trend is updated, both maximum and minimum values are traced on the chart - i.e. two traces are produced for each channel in the group.

The faceplates and pen positions are still updated every second, as normal.

Notes:

- 1 During the period between updates, the maximum and minimum values are shown on the trend as a horizontal line just beneath the pen, where the ends of the line represent the minimum and maximum values so far. This line is removed at trend update time.
- 2 Adaptive recording takes twice as much memory as normal recording, so to maintain the total amount of history stored, the trend speed must be reduced to 50% of that which would be used for non-adaptive recording.
- 3 In Trend History mode, both minimum and maximum values for the cursor position are shown on the faceplate. See [section 3.4](#) for a description of trend history.

Figure 4.3.2b shows the difference between normal and adaptive recording, at slow trend rates. Note that rapid changes in signal, (such as those shown in the circled area of the 'actual signal') are largely filtered out by Normal Tracing, but is displayed by the Adaptive Trace. Figure 4.3.2b is for illustrative purposes only, as traces such as these could never appear on the chart together.

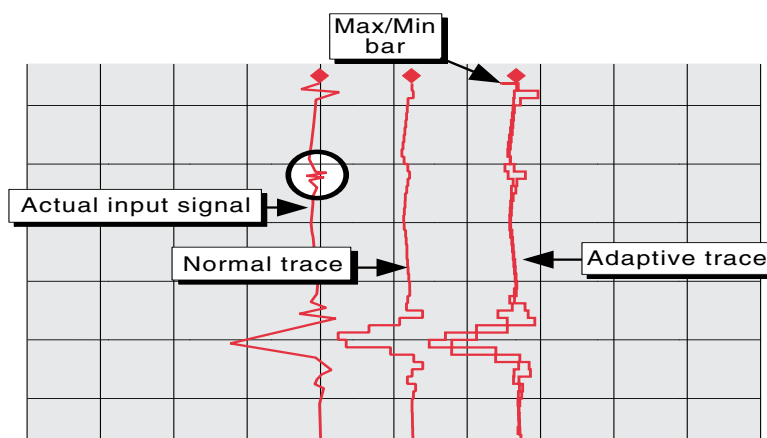

Figure 4.3.2b Adaptive recording compared with Normal tracing

4.3.2 GROUP CONFIGURATION (Cont.)

A/B SWITCHING

If enabled, this function allows alternative values for Trend speed/interval and Recording speed/interval to be entered. 'A' values are used during normal operation. 'B' values are switched-to by job action, as described in [section 4.7](#).

TREND SPEED/TREND INTERVAL

Allows the 'chart' speed to be selected either as mm or in per hour, or as an interval. Entering a value in one field automatically converts the value in the other field. A trend interval of N seconds is equivalent to 1200/N mm/hr chart speed; a chart speed of P mm/hr is equivalent to a trend interval of 1200/P seconds.

If A/B switching is enabled, a second Trend Speed /Interval value can be entered. Trend Speed/Interval 'A' is used during normal operation. Trend Speed/Interval 'B' is switched to by job action, as described in [section 4.7](#).

Note: Trend speed/interval are not editable fields if 'Circular Settings' is enabled.

CIRCULAR SETTINGS

When checked, this checkbox causes the Circular Speed/Chart Full/Start At fields, described below, to appear. When checked, the Trend Speed and Trend Interval fields described above are disabled (i.e. they are no longer editable).

Note: If Circular Settings is not enabled, here in Group configuration, but Circular Trend is enabled for the group in Views configuration ([section 4.3.4](#)), then, although the circular chart will appear, it is unlikely that the chart will contain any trends.

CIRCULAR SPEED

This field allows the chart speed to be selected from a pick list, as detailed in table 4.3.2, below. The table also shows the number of major and minor chart divisions.

CIRCULAR CHART FULL

This allows 'New Chart' or 'Rotate' to be selected from a picklist. See [section 3.4.3](#) for details. Table 4.3.2 shows the major and minor chart divisions for each chart speed.

START AT

This item, (which appears only if 'New Chart' has been selected in 'Circular Chart Full', above) allows the user to select a start time and/or date for the new chart. The exception is for a chart speed of 1 hr/rev, which always starts on the hour.

Chart spd. (1 rev per)	Chart divs		New Chart Start at	
	Major	Minor	Start at choices	Examples/comments
1 hour	12	2	On the hour	
2 hours	12	2	00 to 23 at 00:00 hrs	4 hours/rev.; Start at 12. This chart will start at 1200 hrs and re-start at 1600, 2000, 2400, 0400, 0800 hrs etc.
4 hours	12	2		
6 hours	12	2		
8 hours	8	2		
12 hours	12	2		
16 hours	8	2		
1 day	12	2	Day of week at 00:00:00	2 days/rev.; Start Monday. Chart starts Mon. 00:00:00 and restarts Weds, Fri etc.
2 days	12	2		
1 week	7	4	Day of week at 00:00:00	At each power-on, the system resets to the first week of the period, with the most recent 'Start at' day of the week at the top of the chart.
2 weeks	7	4		
4 weeks	4	7		
30 days	30	0		

Table 4.3.2 Circular chart speed details

4.3.2 GROUP CONFIGURATION (Cont.)

CIRCULAR EXTENDED BACKFILL

When checked, this checkbox enables the Circular Extended Backfill function, which extends the chart backfill to display chart data for multiple power cycles instead of only from the previous power up.

GRID TYPE

Grid type allows the chart grid type to be defined for the group being configured. This is not necessarily related to channel scale (section 4.3.3), unless 'From point' is selected, when the grid matches the scale of the selected point.

NONE

No chart grid is traced.

LINEAR

The chart grid is linear, with the major and minor divisions defined by the fields Grid Divisions - Major and Minor, which appear if 'Linear' is selected as grid type. Figure 4.3.2c, below, defines major and minor divisions.

LOG

The chart grid is logarithmic, with the number of decades being selected in the 'Grid Decades' field which appears if 'Log' is selected as Grid Type. Figure 4.3.2c gives an example.

Note: For the small frame recorder, the minor divisions within each decade are shown only for groups with 'Number of decades' ≤ 5 .

FROM POINT

This allows the chart grid to be aligned with the scale of a particular 'point', selected in the 'from' field which appears if 'From Point' is selected as 'Grid Type'

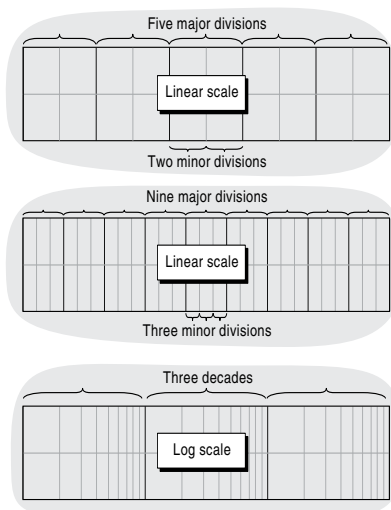

Figure 4.3.2c Typical chart grid definitions

RECORDING ENABLE

This tick box allows the logging of this group's data to the flash memory to be enabled/disabled. When disabled:

- a The recording speed/interval fields are not editable, and Trend History duration is set to zero.
- b Display trends are present on the chart, but are not preserved when changing 'Views'.
- c It is not possible to enter trace history if 'Recording Enable' is not selected.

Notes

- 1 A blue line is drawn across the chart, when recording is re-enabled to indicate a time change in the trace.
 - 2 If a 'Recording enable' job (section 4.7.10) is set to act on a particular group, then the group will be recorded only whilst the job is active, and only if Recording is enabled for the group.
-

RECORDING SPEED/RECORDING INTERVAL

If recording is enabled, these fields are as for trend speed/interval but define the rate at which data is saved to Flash memory. This value also affects how much trace history appears per screen in trend history mode (section 3.4). If recording is not enabled, these fields are 'greyed' and not editable.

If A/B switching is enabled, a second Recording Speed /Interval value can be entered. Recording Speed/Interval 'A' is used during normal operation. Recording Speed/Interval 'B' is switched to by job action, as described in section 4.7.

Note: With large numbers of points configured in one or more groups, the total amount of data generated per iteration may exceed the amount that can be written to the internal FLASH memory in the time available. Such a situation may also arise if many messages are being generated. The recorder responds by reducing the recording speed, and a message 'Recording failed - internal overflow. Slowing recording interval of fastest group(s)' appears, to draw the user's attention to the situation.

TREND HISTORY DURATION

Gives an estimated time to fill the group's trend history area of the Flash memory. The calculation is based on the archive rate, the compression ratio, the flash size and on the exact nature of the data. (Rapidly changing values use more space than static/slowly changing values.) If A/B switching is enabled the calculation is based on Recording Speed/Interval 'A'.

Changing the contents of one group may affect the Trend History Duration of other groups. This happens because the recorder attempts to store, as nearly as possible, the same amount of history for all groups, regardless of how many points there are in the groups.

For 'empty' groups, or if Recording is not enabled for a group, the Trend History Duration is displayed as '0' Days.

ARCHIVE TO MEDIA ENABLE/ARCHIVE VIA FTP/(S)FTP ENABLE

If recording is enabled, these tick boxes allow the archiving of this group's data to removable mass storage media and/or to a remote host (FTP/(S)FTP) to be enabled or disabled. If recording is disabled, these fields cannot be edited.

Note: When recording to floppy disk drives (via a USB port), it is recommended that only one group be set up with 'Archive to media' enabled. This is because history files are typically 400kB in size and this limits the number of files which can be saved to a 1.4MB floppy disk, to three. If more than one group is set up to archive, and if 'Overwrite' strategy is selected, then it is likely that all the data for one or more of the groups will be lost. No warning is given.

ALARM MESSAGE

This box allows the printing of alarm on and off messages on the 'chart' to be enabled or disabled as required. Alarm messages appear on the trend display and in PC Review in the form HH:MM:SS Alarm ON n/m and HH:MM:SS Alarm OFF n/m, where 'n' is the relevant channel number and 'm' is the alarm number (1 or 2).

ACK MESSAGE

This tick box allows the printing of alarm acknowledgement messages on the 'chart' to be enabled or disabled as required. Acknowledge messages appear on the trend display and in PC Review in the form HH:MM:SS.

ALARM ACKNOWLEDGE

Alarms are acknowledged as described in [section 3.1.4](#).

POINT TYPE/SELECTION

The 'Point Type' box, together with the 'Selection' box immediately below, offers a quick way of editing the contents of a group, as follows:

1. Select the type of point (Channel, Maths, Totaliser or Counter) to be edited from the Point Type drop down menu.
2. Enter the numbers of all the points of the selected type to be added or deleted, in the 'Selection' box. See notes below for further details.
3. Click on 'Enable' to add the selected points to the group contents, or on 'Disable' to remove them.
4. Repeat for other point types, as required.

Notes:

1. The status of all points not included in the selection box, remains unchanged.
 2. Point numbers are entered individually, or as one or more ranges, separated by commas (if applicable). For example, an entry of '1-3,6,9-11' would cause points 1, 2, 3, 6, 9, 10 and 11 to be added or removed from the group contents. Only numeric characters, commas and hyphens (minus signs) are accepted. If any other character (including space(s)) is included in the list, the edit will fail, with a message 'Invalid Selection' appearing when the 'Enable' or 'Disable' key is operated..
 3. Ranges must be complete: '1-' is not acceptable.
 4. Each group may contain any or all points, but for vertical and horizontal trend modes, only the first 36 are displayed, and for circular trend mode, only the first twelve are traced..
 5. If a point number is entered which is greater than the number of that point type fitted, then the selection is ignored. For example, if totalisers 1-60 are selected for deletion, and only 12 are enabled, then the range will be accepted, and totalisers 1 to 12 deleted from the group's contents.
-

Alternatively, a group's contents can be edited using the tick-boxes, to include the ticked items in, or to exclude non-ticked items from, the group, as required.

4.3.3 Channel/Alarm configuration

Figure 4.3.3a below, shows a typical configuration menu for an input channel. (For maths channels see [section 4.3.11.](#)) The actual fields that appear depend on what input type is selected, what linearisation type is selected, and so on.

Channel Number **1) Channel 1** → Select channel number

Value **6.6893** 14/09/05 15:10:53

Input Type **Thermocouple** → Off, T/C, mV,V, mA, RTD, Ohms, Digital, Comms or Test

Lin Type **Type K** → Select Linearisation type (e.g.Type K)

Range Low **0** °C

Range High **100** °C

Range Units **°C** → Select: Celsius, Fahrenheit, Kelvins or Rankine

Scaled

Scale Low **0** V

Scale High **1** V

Units **V**

Offset **0** V

Scale Type **Linear** → Select: None, Linear or Log (Log available only if 'Scaled' is ticked.)

Scale Divisions - Major **10**

Scale Divisions - Minor **1** → These fields vary with the type of scale selected

Filter **None** → Select: None, 2, 4, 8, 16, 32, 64,128 or 256 seconds

Break Response **None** → Select: None, High or Low

Cold Junction Type **Internal** → Select: Off, Internal, External, Remote.

Descriptor **Channel 1**

A/B Switching → Allows Span A high/low, Span B high/low, Zone A high/low, Zone B high/low and Colour A/B values to be entered for use by Trend jobs.

Spanned

Span Low **0** V

Span High **1** V

Zone Low **0** %

Zone High **100** %

Pv Format **Numeric** → Select Numeric or Scientific

Max Decimal Digits **4**

Colour **0**

Alarm Number **1** → Select Alarm number

Enable **Unlatched**

Type **Absolute High**

Setpoint Source **Constant**

Threshold **0** V

Hysteresis **0** V

Dwell **0** s

Job Number **1** → Select Job number

Category **Drive Relay**

Relay Board **1**

Relay Number **1** → These fields vary according to the selected job category

while **Active**

Apply Discard

These fields vary according to Input Type selection

These fields appear only if 'Scaled' is selected.

These fields appear only if 'Spanned' is selected.

These fields vary according to Alarm Type selection

Figure 4.3.3a Channel/alarm configuration menu (typical)

Notes

1. Numeric values (e.g. 'input low') can be up to 10 characters including decimal point
2. Refer to [section 3.3.2](#) for numeric and text entry techniques.

4.3.3 CHANNEL/ALARM CONFIGURATION (Cont.)

Example: A type J thermocouple is used to measure a temperature range of 100 to 200 degrees Celsius. This thermocouple output is transmitted to the recorder by a 4 to 20 mA transmitter, for display as an efficiency value between 0 and 100%. In such a case, the following values would be set up:

Input type = milliamp
 Input low = 4.0
 Input high = 20.0
 Shunt = 250 Ohms
 Lin Type = Type J
 Range Low = 100
 Range High = 200
 Range Units = °C
 Scaled =
 Scale low = 0.0
 Scale high = 100
 Scale units = %

Note: The following description shows all possible fields. The recorder itself edits the list and shows only those fields appropriate to the setup so far. For example, the 'Shunt' field appears only for mA input type.

CHANNEL NUMBER

The current channel and its descriptor are displayed. Touching the window area allows another channel to be selected for configuration. Alternatively, the right and left arrow keys at the bottom of the screen can be used to increment and decrement, respectively, the channel number.

VALUE

Shows the current value of the channel, together with either 'Unadjusted' or the date and time of channel adjustment ([section 4.6.4](#)).

INPUT TYPE

According to the options available, one of the following may be selected as input type: thermocouple, millivolt, Volt, milliamp, RTD, Ohms, Digital (not channel 1, 7 etc.), Modbus Comms Input, Ethernet/IP Comms Input, Test or Master Comms.

Select Modbus Comms Input if the channel is to be written-to via Modbus. Use Ethernet/IP if the channel is to be written-to by an Ethernet/IP client. Master Comms must be selected if this channel is to be read from another instrument.

Note: See [section 4.3.16](#) for details of Master Comms, [section 4.3.21](#) for details of the EtherNet/IP option and [section 4.3.15](#) for Modbus comms (Connections).

LIN TYPE

The following linearisation tables are available as standard:

Linear, square root, x3/2, x5/2, UserLin1, UserLin2, UserLin3, UserLin4 (see [section 4.3.9](#) for user linearisations)
 Thermocouple types B, C, D, E, G2, J, K, L, N, R, S, T, U, NiMo/NiCo, Platinel, Ni/NiMo, Pt20%Rh/Pt40%Rh
 Resistance thermometer (RTD) types Cu10, Pt100, Pt100A, JPT100, Pt1000, Ni100, Ni120, Cu53.

For input ranges, accuracies etc. associated with the above thermocouple/RTD tables, see [Annex A](#).

4.3.3 CHANNEL/ALARM CONFIGURATION (Cont.)

INPUT LOW

Enter the lowest value to be applied to the input terminals (e.g. 4.00).

INPUT HIGH

Enter the highest value to be applied across the input terminals (e.g. 20.00).

SHUNT

Allows a shunt resistor value to be entered for input type = mA. Commonly used values are 100 ohms and 250 ohms. Note that shunt resistors are connected to the input connector. The recorder cannot detect whether a shunt is fitted, or if one is, what value it has. Therefore it is the responsibility of the user to ensure that the ohmic value of any shunt fitted matches the shunt value entered in this field.

RANGE LOW

Enter the lowest value of the required linearisation range (e.g. 100)

RANGE HIGH

Enter the highest value of the required linearisation range (e.g. 200)

RANGE UNITS

Selectable from degrees Celsius, degrees Fahrenheit, Kelvin or Rankine.

SCALED

This box allows the user to select low and high values and units for a scale. This box must be ticked if logarithmic scales are to be used.

SCALE LOW

Enter the scale value to correspond with input range low (e.g. 0).

SCALE HIGH

Enter the scale value to correspond with input range high (e.g. 100).

SCALE UNITS

Enter up to five characters of unit descriptor (e.g.%).

Note:

User linearisation table units,

To set user linearisation table units to temperature units (°C for example), the Range Units selection box can be used.

To enter custom units, 'Scaled' must be selected. Scale low must be set to Range Low; Scale high must be set to Range High. The required Units string is entered in the Scale units text entry box.

OFFSET

Allows a fixed value to be added to or subtracted from the process variable. Recorder accuracy figures no longer apply if an offset is included.

If the TUS option is fitted (section 15), Offset can not be applied to channels used as reference channels (e.g. channels 6, 12, 18 etc.).

4.3.3 CHANNEL/ALARM CONFIGURATION (Cont.)

SCALE TYPE

This field allows 'None', 'Linear' or 'Log' to be selected as scale type. For linear scales, the number of major/minor scale divisions can be selected. This does not affect the 'chart' grid divisions, which is set up as a part of Group configuration (section 4.3.2). Figures 4.3.3b1 and 4.3.3b2 show various examples.

NONE

Channels with Scale Type selected to 'None', appear with no scale information in any display mode.

LINEAR

Channels with Scale Type = Linear, appear with scale information in all display modes (except numeric). The number of major and minor divisions can be selected from subsequent fields. Examples are shown in figure 4.3.3b1.

SCALE DIVISIONS - MAJOR

Appears for Linear Scale types only. Setting major divisions to 1, means that the scale consists only of 'zero' and full scale. Setting Major divisions to 2, means that the scale has divisions at zero, 50% and full scale, and so on. Intermediate scale values appear at major divisions if there is sufficient space. Default = 10 for large frame recorders or 5 for small frame units.

SCALE DIVISIONS - MINOR

Appears for Linear Scale types only. With minor divisions set to 1 (default), the scale major divisions are not divided i.e. no minor division tick marks appear. Setting Minor divisions to 2, means that each major scale division is divided into two, and so on. See figure 4.3.3b1 for an example showing five minor divisions.

LOG

For some input type selections, this appears only if 'Scaled' is ticked.

Channels with Scale Type = Log, appear with logarithmic scales. These scales have major divisions at each decade boundary, and (space permitting), minor divisions for mantissa values 2 to 9. Examples are shown in figure 4.3.3b1. Because of the nature of logarithms, neither negative values nor the value 0 can be used as scale 'zero'. Linear inputs are traced as exponential curves (figure 4.3.3b2).

LOG/LINEAR

For some input type selections, this appears only if 'Scaled' is ticked.

Channels with Scale Type = Log/Linear, appear with logarithmic scales. These scales have major divisions at each decade boundary, and (space permitting), minor divisions for mantissa values 2 to 9. Examples are shown in figure 4.3.3b1. Because of the nature of logarithms, neither negative values nor the value 0 can be used as scale 'zero'. Linear inputs are traced as straight lines (figure 4.3.3b2).

4.3.3 CHANNEL/ALARM CONFIGURATION (Cont.)

Scale = Linear: Major divisions = 10; Minor divisions = 1
(Standard for 180mm recorders)



Scale = Linear: Major divisions = 10; Minor divisions = 5
Intermediate scale values displayed only if room permits.

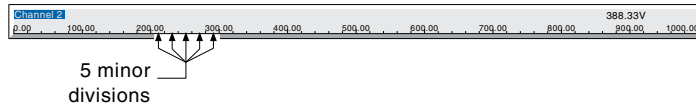

Scale = Log

Number format = Scientific (1.00 x 10⁰ to 1.00 x 10⁶)

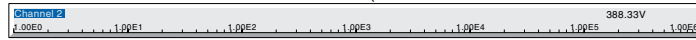

Scale = Log

Number format = Numeric (1.00 to 1,000,000.00)

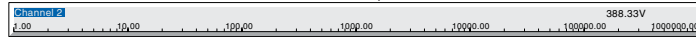

Figure 4.3.3b1 Scale type examples (large frame)

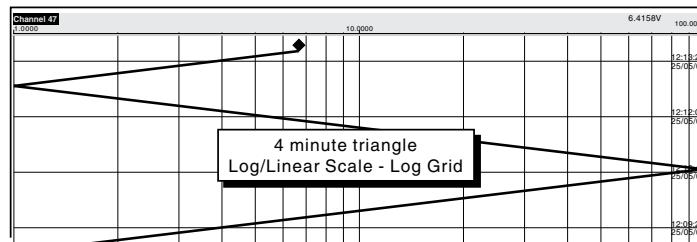
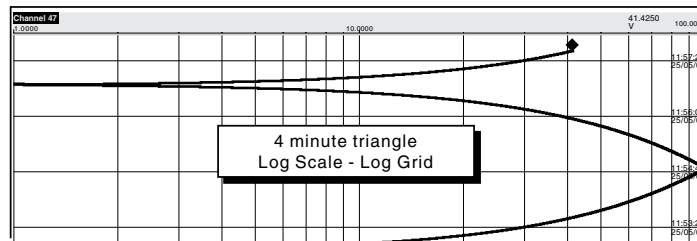
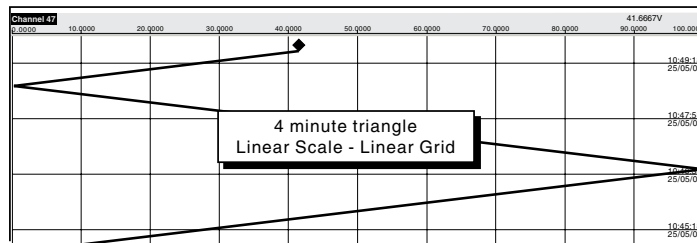
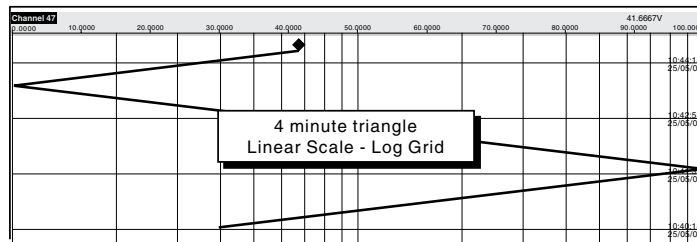

Figure 4.3.3b2 Trace examples for different scale types (large frame)

Note: Grid type is selected in Group configuration. Grid (and chart text) colour is defined in 'Trend Foreground' in System/Customisation configuration

4.3.3 CHANNEL/ALARM CONFIGURATION (Cont.)

FILTER

For 'noisy' slowly changing signals, damping can be used to filter noise so that the underlying trend can be seen more clearly. None, 2, 4, 8, 16, 32, 64, 128 or 256 seconds can be selected.

It is not recommended that damping be used on quickly changing signals.

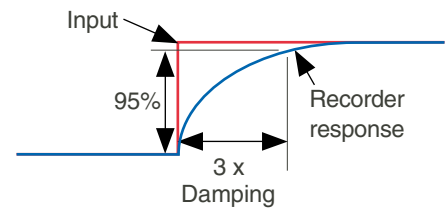

Effect of damping on step change in input signal

Figure 4.3.3c Channel filter

BREAK RESPONSE

For thermocouples and other low level inputs (i.e. input voltages less than 150 mV), the recorder can be made to respond in one of the following ways, if a break in the input circuit is detected.

None trace drifts with the input wiring acting as an aerial.

High trace placed at full scale.

Low trace placed at scale 'zero'.

COLD JUNCTION COMPENSATION (CJC)

For input type = thermocouple, None, Internal, External or Remote can be selected for cold junction compensation.

INTERNAL

Internal CJC is by means of an RTD connected across pins 11 and 12 of the input board connector.

EXTERNAL

If the cold junction is maintained (by the user) at a known, fixed temperature, 'external' should be selected. An extra numeric entry box appears to allow the user to enter the temperature at which the cold junction is maintained.

Break Response	None ▼
Cold Junction Type	External ▼
External CJ Temp	0
Descriptor	Channel 1

REMOTE

'Remote' is selected if the cold junction temperature is to be measured by an external device connected to the instrument. An extra picklist appears which allows the user to select any input or maths channel to act as the cold junction temperature source channel. The temperature units displayed here, are those of the channel being configured, not those of the CJ source channel. The CJ source channel must be configured appropriately for the external device, and must provide a value which is consistent with the configured channel's units.

Break Response	None ▼
Cold Junction Type	Remote ▼
Remote CJ Temp from	Channel 3 ▼ °C
Descriptor	Channel 1

DESCRIPTOR

Allows a text string of up to 30 characters (including spaces) to be entered for the channel descriptor (e.g. 'Turbine 2 tempA').

A/B SWITCHING

If enabled, this function allows alternative Span, Zone and Trace Colour values to be entered. 'A' values are used during normal operation. 'B' values are switched to by job action, as described in [section 4.7](#).

4.3.3 CHANNEL/ALARM CONFIGURATION (Cont.)

SPANNED

This box, when selected, allows span low and high values to be entered. For example, in an input range of 0 to 600 deg C, it may be that the temperature range between 500 and 600 degrees is of most interest. In such a case, setting span low to 500 and span high to 600 will cause the recorder to display only that part of the input range, and this will fill the zone width which is selected next, effectively magnifying the area of interest.

If A/B switching is enabled, a second set of span low and span high values can be entered. 'A' values are used during normal operation. 'B' values are switched to by job action, as described in [section 4.7](#).

ZONE

This allows the portion of the chart which the channel occupies to be defined in terms of percent, where the left edge of the chart is 0% and the right hand edge is 100%. For example, setting a low value of 50 and a high value of 100 causes the channel trace to be confined to the right hand half of the chart.

If A/B switching is enabled, a second set of zone low and zone high values can be entered. 'A' values are used during normal operation. 'B' values are switched to by job action, as described in [section 4.7](#).

PV FORMAT

This allows the PV value, alarm setpoints, hysteresis values etc. to be displayed as normal numeric values (Numeric) or in 'Scientific' format (Scientific). When 'Scientific' is selected, values are displayed and entered as a decimal number between 1 and 10† (the mantissa), followed by a multiplier (the exponent). E.G. to enter a value of 1244.5678, the value entered would be 1.2445678E3, where 3 represents the number of places that the decimal point has been shifted to the left in order to convert the value to a number between 1 and 10†. To enter a value of 0.0004196, the entry would be 4.196E-4.

† Notes

1. Strictly this is a number less than 10, as 10 would be 1.0E1.
 2. There must be at least one number after the decimal point.
-

MAXIMUM DECIMAL DIGITS

This defines the number of decimal places in the process value. Settable between zero and nine. Leading and trailing zeros are not displayed. Values too long for the available displaying width are truncated as described in section 3.

COLOUR

Allows the trace colour to be selected from a colour chart. Each of the 56 available colours is displayed with a number, and it is this number which is entered. The background colour to the selection box changes to the selected colour.

If A/B switching is enabled, a second colour selection can be entered. Colour 'A' is used during normal operation. Colour 'B' is switched to by job action, as described in [section 4.7](#).

ALARM NUMBER

Allows an alarm to be selected for configuration.

4.3.3 CHANNEL/ALARM CONFIGURATION (Cont.)

ENABLE

Allows the alarm to be defined as Off, Unlatched, Latched or Trigger.

Off	Alarm is disabled and the remainder of the alarm configuration is hidden.
Unlatched	Unlatched alarms become active when the trigger source becomes active and remain active until the source returns to a non-active state. The indicator is on (flashing before acknowledgment - steady after acknowledgment) until the alarm clears. Alarm messages are printed if enabled in group configuration.
Latched	Latched alarms become active when the trigger source becomes active and remain active until the alarm is acknowledged AND the trigger source has returned to a non-active state. The indicator is on (flashing before acknowledgment - steady after acknowledgment) until the alarm has been acknowledged AND the trigger source has returned to a non-active state. Alarm messages are printed if enabled in group configuration. Continuous jobs remain active only whilst the alarm trigger source is active. I.E. the job finishes when the alarm clears, whether acknowledged or not.
Trigger	When triggered all associated jobs are initiated, and continuous jobs remain active until the alarm clears. There is no alarm indication, and no messages are printed.

TYPE

This field appears only when the alarm Enable is not selected Off. Each alarm can be defined as absolute high, absolute low, deviation-in, deviation-out, rate-of-change rise or rate-of-change fall.

Absolute High	As shown in figure 4.3.3d, an absolute high alarm becomes active when the channel value exceeds the threshold value. The alarm remains active until the channel value falls below (Threshold minus hysteresis). If a dwell value is defined, the alarm does not become effective until this dwell time has been exceeded.
Absolute Low	As shown in figure 4.3.3d, an absolute low alarm becomes active when the channel value falls below the threshold value. The alarm remains active until the channel value exceeds (Threshold + hysteresis). If a dwell value is defined, the alarm does not become effective until this dwell time has been exceeded.
Deviation in	As shown in figure 4.3.3e, a deviation-in alarm becomes active whenever the channel value enters the band: Reference \pm Deviation. It remains active until the channel value leaves the band: Reference \pm (Deviation+ Hysteresis). If a dwell value is defined, the alarm does not become effective until this dwell time has been exceeded.
Deviation out	As shown in figure 4.3.3e, a deviation-out alarm is active whenever the channel value leaves the band Reference \pm Deviation. It remains active until the channel value enters the band: Reference \pm (Deviation - Hysteresis). If a dwell value is defined, the alarm does not become effective until this dwell time has been exceeded.
Rate of change	As shown in figure 4.3.3f, rate of change alarms become active whenever the signal value changes by more than a specified amount within a specified period. If a dwell value is defined, the alarm does not become effective until this dwell time has been exceeded. An averaging period can be set to remove the effects of sudden, but short-lived changes, such as noise spikes on the signal.

Note: Alarm icons appear at the display, as described in section 3.

SETPOINT SOURCE

Allows the user to choose either a fixed, user-defined value (constant) or the value of another point (input channel, maths channel, totaliser etc.) to be chosen as the trigger point. In the latter it is possible, for example, to trigger an alarm, when one channel's value rises above, falls below etc. the value of a second channel.

4.3.3 CHANNEL/ALARM CONFIGURATION (Cont.)

PARAMETERS

Figures 4.3.3d, e and f illustrate the following terms for the different alarm types.

Threshold	For Absolute alarms, this defines the value (in engineering units) at which an alarm is triggered. The alarm also returns to its non-active state at this value (unless a hysteresis value has been set). If a dwell value is set, the alarm does not become active until this dwell time has elapsed.
Hysteresis	Defines a 'deadband' (in engineering units) to eliminate spurious triggering if the signal value is hovering around the trigger point. The deadband lies: Below Absolute High thresholds Above Absolute Low thresholds Outside the deviation band for Deviation-in alarms Inside the deviation band for Deviation-out alarms.
Dwell	Allows a dwell period to be entered in seconds. The alarm does not take effect until this period has expired. If an alarm clears before the dwell period has expired, the alarm is ignored.
Reference Deviation	For Deviation alarms, this is the central value of the deviation band. For Deviation alarms, this value defines the width of the deviation band, each side of the reference value. I.E. the total width of the deviation band is 2 x Deviation value.
Amount	For Rate-of-change alarms, this value defines the minimum amount by which the signal value would have to change, within the 'Change Time' period (below), in order for the alarm to become active.
Change Time	For Rate-of-change alarms, this selects the time period (Per second, Per minute, Per hour) within which the change in signal value must exceed the Amount value (entered in the preceding field) in order for the alarm to become active. See Rate-of-Change example below for more details.
Average time	For rate-of-change alarms, this allows an average period to be entered for signal smoothing.

HYSTERESIS EXAMPLE

Threshold = 100 units; Hysteresis = 5 units

With the above settings, an absolute high alarm would become active if its input were to rise above 100 and would remain active until its value fell to below 95 units. An absolute low alarm would become active if its input fell below 100 units, and would remain active until its input rose above 105 units. Deviation alarms behave in a similar manner.

RATE-OF CHANGE ALARM EXAMPLE

Rate-of-change alarms allow the user to enter an 'amount' (say 3 degrees) and a time period (say 1 minute), and if the process value changes by the specified amount or more, within the specified time period (more than 3 degrees in a minute in this example), then the alarm becomes active.

The recorder uses its iteration rate of 125 msec (1/8th second) as the time base for its calculations. For our example, 3 degrees per minute equates to 3/60 degrees per second or $3/(60 \times 8) = 0.00625$ degrees per iteration. If a change greater than this is detected, then the alarm becomes active.

In order to reduce sensitivity, an averaging period can be configured. This means that an average of all the 1/8th second samples is taken over the specified period, and the alarm becomes active only if the average value exceeds the specified rate of change.

Configuring a dwell time can also reduce 'jitter' because, if during the specified dwell time, any one sample is non active, then the elapsed dwell time is reset to zero. The alarm becomes active only after the dwell time has elapsed i.e. only if the rate of change has been exceeded for every software cycle throughout the specified dwell time.

4.3.3 CHANNEL/ALARM CONFIGURATION (Cont.)

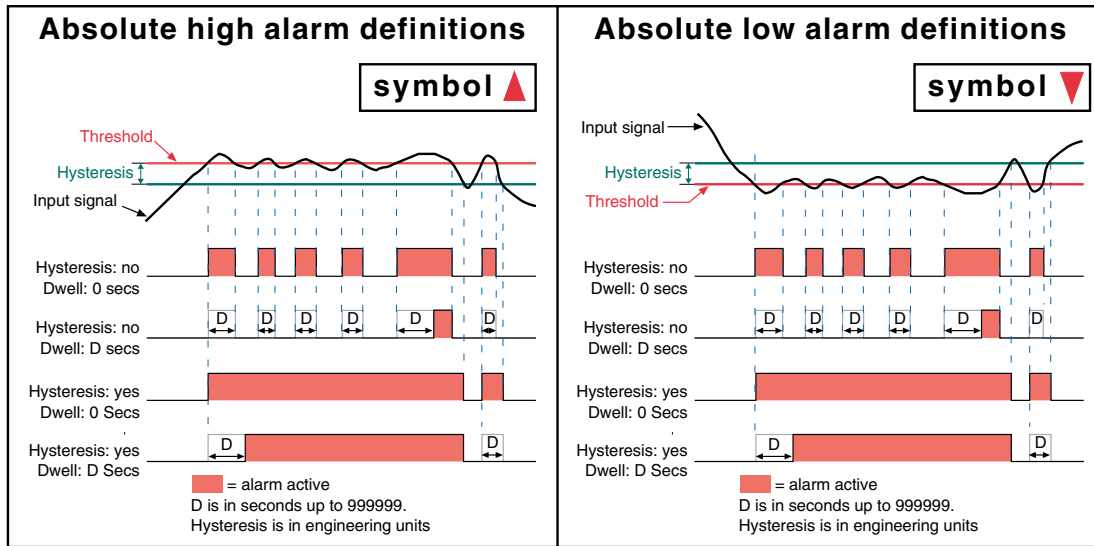

Figure 4.3.3d Absolute alarm definitions

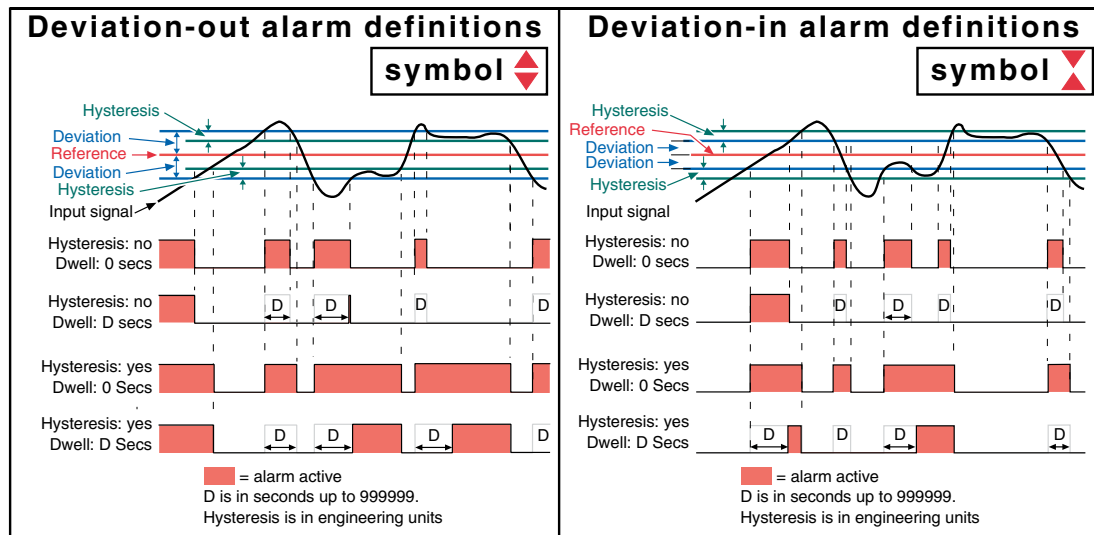

Figure 4.3.3e Deviation alarm definitions

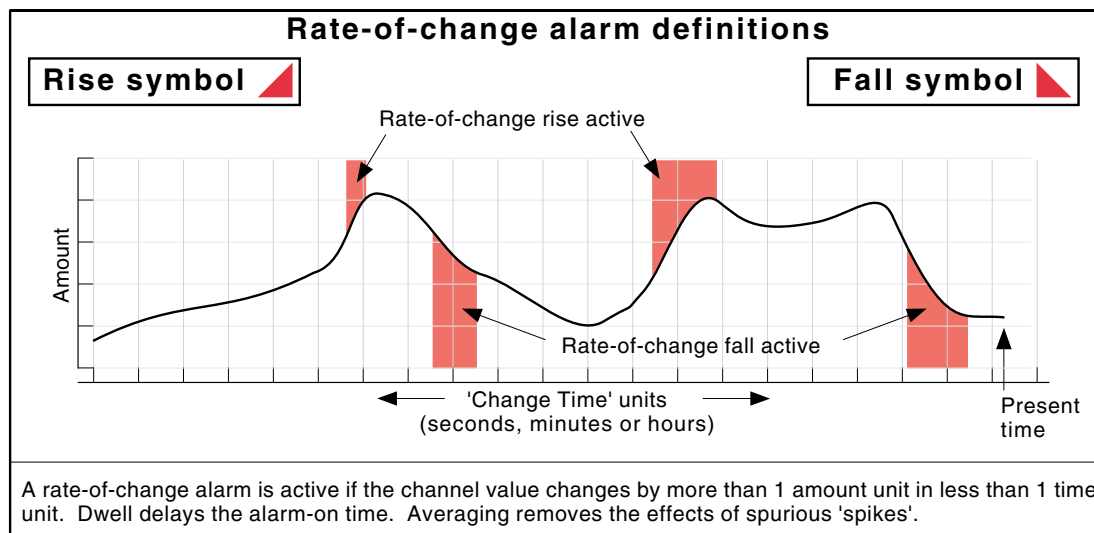

Figure 4.3.3f Rate-of-change alarm definitions

4.3.3 CHANNEL/ALARM CONFIGURATION (Cont.)

JOB NUMBER

Select the required job number.

CATEGORY

Select the required job to be carried out when the channel is in alarm (e.g. Drive relay) See section 4.7 for a description of job categories.

WHILE/ON

Allows the action of the alarm job to be chosen as

- while active, while inactive or while unacknowledged for continuous jobs (e.g. drive relay), or,
- on going active, on going inactive or on acknowledgement for 'one-shot' jobs (e.g. increment counter).

Figure 4.3.3g, below, shows the various actions graphically. For 'While unacknowledged' and 'on acknowledgement' settings, two cases are shown, one where the alarm goes inactive before acknowledgement; the other where the alarm is acknowledged whilst the alarm is still active. The coloured (shaded) areas show the duration for which continuous jobs run; the down arrows show trigger points for 'one-shot' jobs. See [section 3.1.4](#) for details on how to acknowledge alarms.

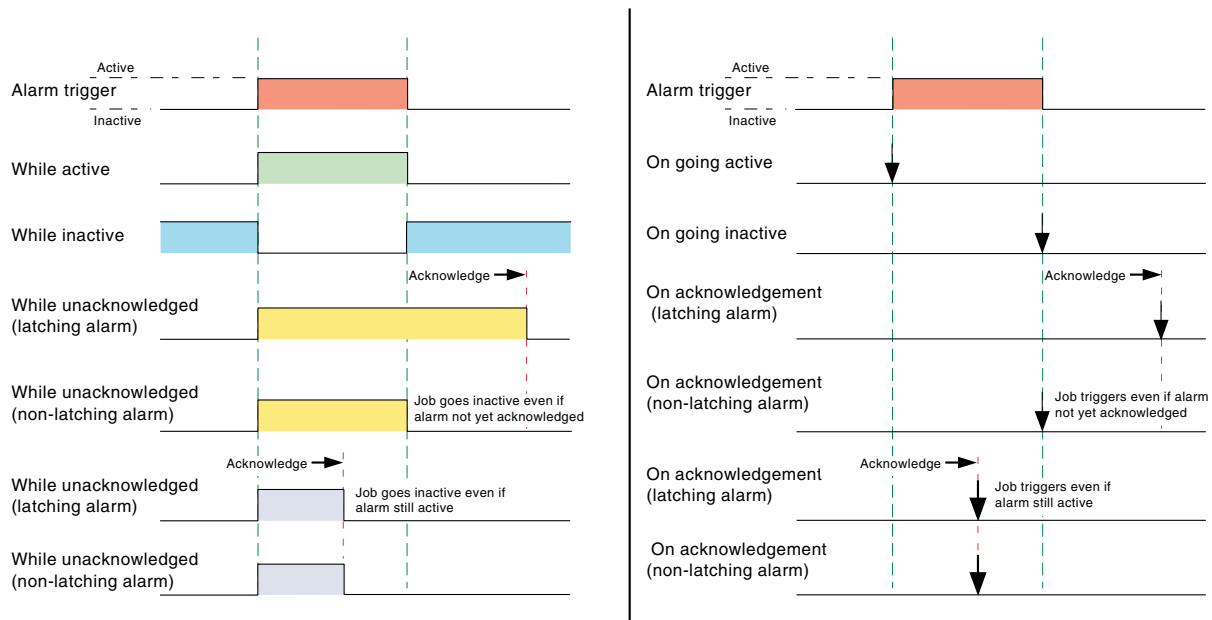

Figure 4.3.3g Graphical representation of job actions

ALARM MESSAGES

Alarm on/off and alarm acknowledge message printing on the chart can be enabled/disabled as a part of 'Group configuration' described in section 4.3.2. See [section 3.1.4](#) for details on how to acknowledge alarms.

4.3.4 Views Configuration

This part of the recorder's configuration allows groups to be set up (either individually, or globally) to include the various display modes described in [section 3.4](#), above, and [user screens](#) (if fitted). When enabled, a display mode is added to the Group's 'Goto View' menu and to the up/down arrow scroll list.

Home Group and Home Page picklists allow a group and display mode to be defined for display when the Home key is pressed in the Root menu.

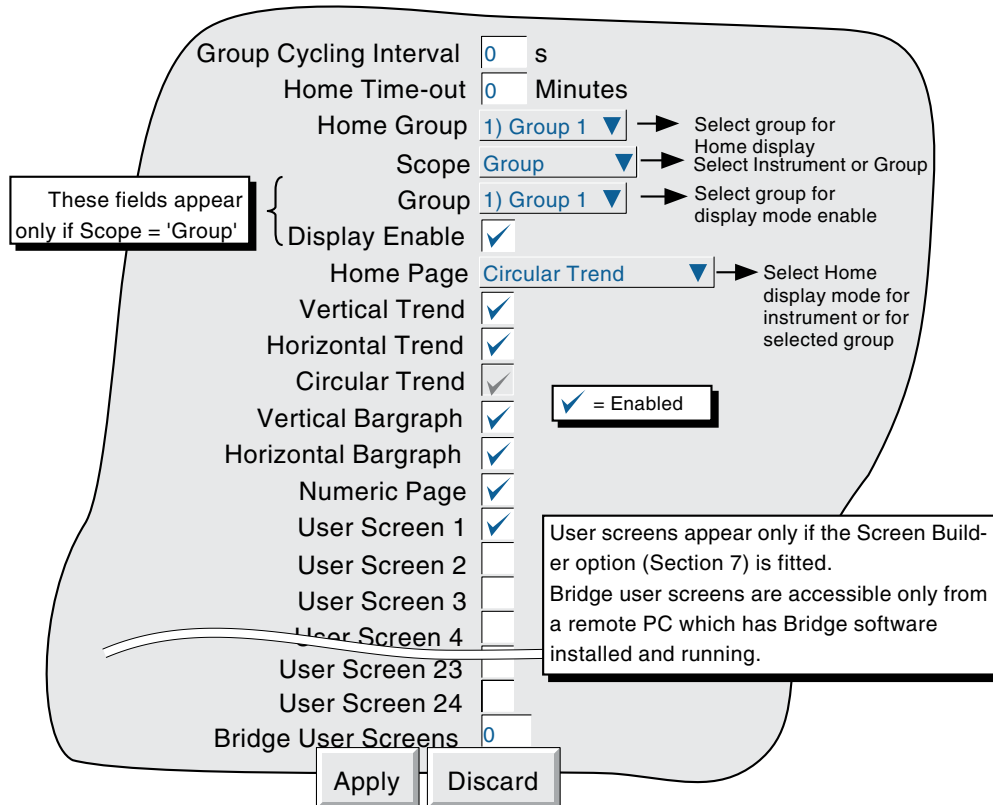

Figure 4.3.4a Views Configuration menu

GROUP CYCLING INTERVAL

When enabled (set to a value between 10 and 99 seconds), groups will automatically cycle when a group view is selected for display, pausing for the set number of seconds before moving onto the next group. Disable by setting this to zero.

HOME TIMEOUT

The recorder returns to the specified home page after the timeout value of minutes has elapsed since the last touch on the display. Timeout action is inhibited if a configuration is incomplete (there are changes which have not been 'Applied'), or if a system-generated message (e.g. 'Clock Failure') is on display. User displays (e.g. Root menu) are timed-out after approximately 50 seconds.

A value of zero disables the time-out function. Valid entries are between 1 and 99 minutes.

HOME GROUP

This picklist allows a particular group to be selected for display when the root menu 'Home' key is pressed.

4.3.4 VIEWS CONFIGURATION (Cont.)

SCOPE

The remaining items of Views configuration can be selected to act globally (Instrument) or to act on individual groups (Group). When 'Instrument' is selected, enabled display modes appear in all groups' up/down arrow scroll lists and are active in the Root Menu 'Goto View' menu (figure 4.3.4b). When 'Group' is selected, each group can be set up with individual display mode lists. For the particular group on display, the up and down arrow keys can be used to scroll through the enabled display modes, or a particular mode can be selected using the 'Goto View' menu.

GROUP

This field appears only if 'Scope' is set to 'Group', and allows each group to be selected for display configuration. For other items of Group configuration, see [Section 4.3.2](#).

DISPLAY ENABLE

This field appears only if 'Scope' is set to 'Group', and allows the selected group to be enabled or disabled for display. When enabled, the group can be displayed either by using the 'Root menu/Goto screens/Group N' selection (figure 4.3.4b) or can be scrolled-to using the right/left arrow keys. When disabled, the group is 'greyed' in the 'Root menu/Goto screens/Group N' selection and is skipped when using the right/left arrow keys. It is not possible to disable the Home group.

HOME PAGE

Allows a particular display mode to be selected as the default display, either for all groups (Scope = instrument) or on a group-by-group basis (Scope = group).

DISPLAY MODE ENABLING

A series of tick boxes allow the various display modes to be added to (or removed from) the up/down arrow scroll list and to be activated/deactivated in the Root menu 'Goto View' menu, either for all groups (Scope = instrument) or on a group-by-group basis (Scope = group). It is not possible to disable the selected Home page mode.

Note: If Circular Trend view is enabled here in Views configuration, but the 'Circular settings' checkbox is not enabled in Group configuration ([section 4.3.2](#)), then, although the circular chart will appear, it will not contain any trends.

4.3.4 VIEWS CONFIGURATION (Cont.)

USER SCREENS 1 to N

This field appears only for recorders with the Screen Builder option (fully described in [section 7](#)). Up to 24 user screens can be included in the up/down arrow scroll list and to be active in the Root menu 'Goto View' menu (figure 4.3.4b).

In addition to the 24 screens accessible from the recorder display, up to 100 extra screens, which can be accessed only by using Bridge 'Full' software, can be specified. The number selected should be kept to the minimum necessary, in order to reduce the number of 'Goto View' 'More...' displays. Once created a Bridge screen can be copied to one or more recorder screens 1 to 24 if required, making it accessible from the recorder.

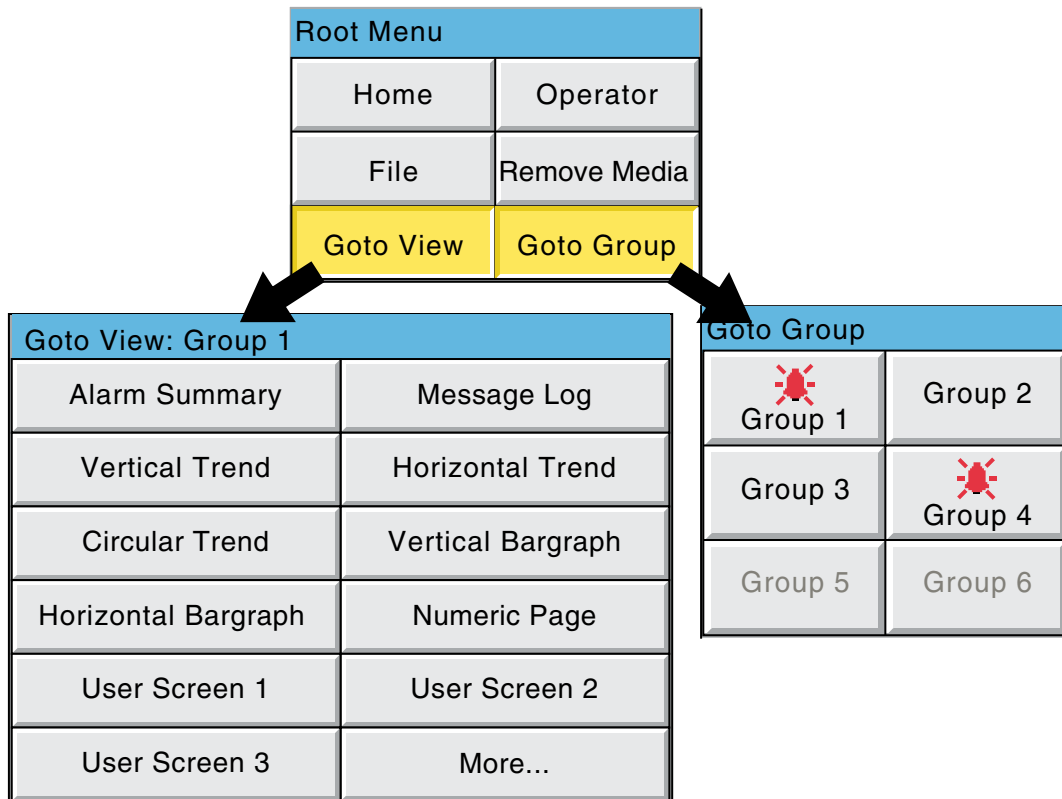

Figure 4.3.4b Goto View and Goto Group submenus

4.3.5 Archive configuration

Notes:

1. For the sake of brevity, the phrase 'memory device' is used for whatever mass-storage medium is fitted to the recorder (integral or via a USB port).
2. CSV format files are not as secure as Packed Binary format files.

This allows an archive strategy to be set up for saving data to a local memory device or to a remote PC. The local strategy includes archive period, memory device full operation, compression factor and an estimate of the maximum-time-to-next-archive to avoid data being overwritten in memory (Duration).

The recorder uses a dedicated area of its Flash memory as an archive data buffer, which means that data is written to the memory device or remote PC only when required, rather than continuously.

In order to carry out a successful remote archive, details of the remote host must be entered both in this Archive section of the 'Config' menu, and in Network configuration ([section 4.5](#)). Further, the current access level must have 'Connect from remote' enabled in the Security/Access menu ([section 4.4.1](#)).

Compression **Normal** ▼ → Select: Normal or High
Flash Size **99.25** Mb
Shortest Trend History **Group 1**
Duration **108.6** Days
Show **Local settings** ▼ → Select Local or Remote settings
Media **mediacard** ▼ → Select Media card or USB port
Archive to Media **Automatic** ▼ → Select archive frequency
Archiving **Hourly** ← Appears only for 'Automatic'
Media file format **Binary** ▼ → Select Binary and/or CSV
On Media Full **Overwrite** ▼ → Select: Overwrite or Stop
Media Size **30.4746094** Mb
Removable Media Capacity **33.18** Days
Media Full event limit **100** %

Apply **Discard**

Figure 4.3.5a Archive configuration menu (Local settings)

Compression **Normal** ▼ → Select: Normal or High
Flash Size **99.25** Mb
Shortest Trend History **Group 1**
Duration **108.06** Days
Show **Remote settings** ▼
Archive to Remote **None** ▼ → Select archive interval
Ftp File format **Binary** ▼ → Select Binary and/or CSV
Remote path **/recorder/Group1**
Primary remote host **0.0.0.0**
Primary login name **anonymous**
Primary password *********
Retype password *********
Secondary remote host **0.0.0.0**
Secondary login name **anonymous**
Secondary password *********
Retype password *********

Apply **Discard**

Figure 4.3.5b Archive configuration menu (Remote settings)

4.3.5 ARCHIVE CONFIGURATION (Cont.)

COMPRESSION

Select Normal or High compression. 'Normal' compresses the data but still provides an exact copy. 'High' compresses more, but channel values are saved only to 1 part in 10⁸ resolution. This field does not appear if 'CSV' is selected as file format (see below).

Note: Where very high values are involved (e.g. some totaliser values) 'High' compression may cause the value displayed by the recorder, and held in the history file, to be incorrect. This problem may be solved by moving the relevant point to a group using 'Normal' compression, or by re-scaling the totaliser to read (for example) TeraWatt hours instead of Megawatt hours.

FLASH SIZE

Allows the size of the internal flash memory to be viewed by the user.

SHORTEST TREND HISTORY / DURATION

This shows which group has the shortest amount of Flash memory allocated to its history record. Providing the archive period is less than the value displayed in the Duration window, no data will be lost from any group. If the archive period is greater than this value, then some of the data in one or more groups will have been overwritten and therefore lost.

If there is more than one group with the same Shortest Trend History Duration, the group with the lowest number is displayed. (E.G. If groups two and four both have the same duration, 'Group 2' will appear in this window.)

Note: Trend history duration depends on many factors, as described in Group Configuration (section 4.3.2) above.

CSV CHECK BOXES, DATE/TIME FORMAT

These appear only if the 'Media File Format' or 'FTP file format' are set to either 'CSV' or 'Binary and CSV'. Refer to '[CSV Files](#)' at the end of this subsection (4.3.5).

SHOW

This allows the fields which are to appear below 'Show' to be applicable to the local memory device (Local Settings), or to the setting up of a remote host path for archiving purposes (Remote settings). The following descriptions contain all the fields which may appear in either menu.

MEDIA

For 'Local' setting only

For standard recorders, this allows 'mediacard or 'usbfront'' to be selected as the local archive destination. If the USB option is fitted, the two rear USB ports (usb1 and usb2) also appear in the pick list. USB ports may support both floppy disk drives and 'memory sticks'.

4.3.5 ARCHIVE CONFIGURATION (Cont.)

ARCHIVE TO MEDIA

For 'Local' setting only:

None	Archive must be initiated by the operator (section 4.1)
Hourly	Archive occurs on the hour every hour
Daily	Archive occurs at 00:00* hrs each day
Weekly	Archive occurs at 00:00* hrs every Monday
Monthly	Archive occurs at 00:00* hrs on the 1st of each month
Automatic	The recorder selects the least frequent archive period (Hourly, Daily, Weekly, Monthly), which is guaranteed not to lose data as a result of either the internal Flash, or the local memory device, running out of space (calculated assuming that the memory device is initially 'empty'). When Automatic is selected, a further, non-editable menu item appears, showing which of the archive frequencies has been selected.

*Note: Archive times are not adjusted for Daylight Saving hour changes. Thus if the archive is set to 'daily', 'weekly' or 'monthly' then, during 'Summer Time', the archive will occur an hour late (i.e. at 01:00 hrs. instead of midnight).

MEDIA FILE FORMAT/FTP(S)FTP FILE FORMAT

Allows 'Binary' (.uhh) files, 'CSV' (.csv) files or 'Binary and CSV' to be chosen for FTP(S)FTP transfer. For further details of [CVS](#) archiving, see description at the end of this subsection (4.3.5).

ON MEDIA FULL

For 'Local' setting only:

Overwrite	Oldest data is replaced with latest data when storage medium is full.
Stop	Archiving stops when the storage medium is full.

Note: When in 'Overwrite' mode, the recorder will overwrite only those files which it has itself created. Thus, if a storage medium is inserted which contains history files from another recorder, these cannot be overwritten. The file names are of the form UUU...UUUIIIIIFFGSSSSSS, where IIIII represent the lowest three bytes of MAC address of the recorder which created the file (see [section 4.5.1](#)). It is not possible for the user to delete files created by another instrument (i.e. one with a different MAC address).

Note: The 'Overwrite' mode is limited (to approximately 2000 files), therefore it depends on the correct storage medium capacity. The recommended storage medium size is 1GB. If the storage medium size is increased users should consider using the 'Stop' mode in conjunction with the 'Media Full Event Limit' function to provide a sustainable method for larger archives of data.

MEDIA SIZE

For 'Local' setting only, this displays the capacity of the memory device.

REMOVABLE MEDIA CAPACITY

For 'Local' setting only, this gives an estimated time to fill the archive medium, based on the archive rate, the compression ratio, the storage medium size and on the exact nature of the data. (Rapidly changing values use more space than static/slowly changing values.) When archiving to Floppy disks (via USB port), this field remains empty until after the first archive has taken place.

MEDIA FULL EVENT LIMIT

For 'Local' setting only, this allows the user to specify a percentage-full value for the storage medium, at which the event source 'Archive media % full' is triggered. The event remains active until the storage medium is replaced, or has data removed from it to make more room available.

4.3.5 ARCHIVE CONFIGURATION (Cont.)

ARCHIVE TO REMOTE

For 'Remote' setting only:

None	Archive to host is initiated by the operator (section 4.1.2)
Hourly	Archive to host occurs on the hour every hour
Daily	Archive to host occurs at 00:00* hrs each day
Weekly	Archive to host occurs at 00:00* hrs every Monday
Monthly	Archive to host occurs at 00:00* hrs on the 1st of each month
Automatic	The recorder selects the slowest out of 'Hourly', Daily, Weekly or Monthly, which is guaranteed not to lose data (depends on the size of the Trend History Buffer).

*Note: Archive times are not adjusted for Daylight Saving hour changes. Thus if the archive is set to 'daily', 'weekly' or 'monthly' then, during 'Summer Time', the archive will occur an hour late (i.e. at 01:00 hrs. instead of midnight).

REMOTE PATH

For Remote setting only, this specifies the route to a folder or directory on the remote host, set up as a part of that host's FTP/(S)FTP configuration. The path name may be up to 103 characters in length.

PRIMARY REMOTE HOST

For 'Remote' setting only:

If a Domain Name Server (DNS) is specified in the Network key 'Name' page ([figure 4.5.2](#)), then the Primary Remote Host is the server name. If DNS is not selected, then the Primary Remote Host is the IP address of the remote host, set up in the host's Control Panel\Network.

PRIMARY LOGIN NAME/PASSWORD

For 'Remote' setting only:

Login name and password of the remote host account assigned either by the Network administrator, or in the Guest account of the remote host's FTP/(S)FTP Server or User Manager configuration. The password, which must be of between eight and 20 characters, must be entered twice to ensure integrity.

SECONDARY REMOTE HOST/LOGIN/PASSWORD

For 'Remote' setting only:

As for primary versions, but for a secondary host. The secondary route is used only if the primary route fails.

4.3.5 ARCHIVE CONFIGURATION (Cont.)

CSV FILES

This allows archive files to be transferred in comma-separated-values (CSV) format, to a memory device or, via FTP/(S)FTP, to a remote host computer.

Compression Normal ▼ → Binary format only

Flash Size 99.25 Mb

Shortest Trend History Group 1

Duration 108.86 Days

CSV include Values

CSV include Messages

CSV include Header details

CSV include Column headings

CSV Date/Time format Text ▼

CSV use Tab delimiter

Show Local settings ▼

Archive to Media None ▼

Media file format Binary and CSV ▼

On Media Full Overwrite ▼

Media Size 30.4746094 Mb

Disk Archive Capacity 33.18 Days

Media Full event limit 100 %

Apply Discard

Figure 4.3.5c CSV archive menu items

MEDIA FILE FORMAT

For Local Settings only, this allows 'Binary', 'CSV' or both to be selected for file type when archiving. 'Binary' is the proprietary format used by the instrument and it requires other software (e.g. Review Software) to interpret the data, before it can be presented in spreadsheets, shown as if on a chart etc. Binary files have the extension '.uhh'.

CSV format is a standard open-file format for numeric data. A simple ASCII-based format, it is readable by a wide range of PC applications as well as being suitable for direct import into many commercial databases. CSV files have the extension '.csv'.

Note: CSV is ASCII based, and cannot interpret Unicode characters. Some characters available to the user will therefore be displayed incorrectly in CSV files.

If 'CSV' or 'Binary and CSV' is selected, a number of extra check boxes appear. Figure 4.3.5c above, shows a typical menu page. Figure 4.3.5d below, shows the effects of enabling the CSV check boxes, with the exception of 'CSV use Tab delimiter' the use of which is as follows:

CSV USE TAB DELIMITER

Despite its name, CSV does not always use commas as separators.

For example, in some countries, the decimal point is represented by a full stop (period), whilst in other areas, a comma is used. In order to avoid confusion between the comma as a decimal point and the comma as a separator, a different separator is used, usually the semicolon.

The instrument automatically chooses a separator suitable for use with the 'Locale' selected in System Configuration (section 4.6.2). 'CSV Use Tab delimiter' allows the user to override this choice, and force the instrument to use tabs as separators. This can be particularly useful when moving the data from one locale to another.

4.3.5 ARCHIVE CONFIGURATION (Cont.)

CSV DATE/TIME FORMAT

Allows 'Text' or Spreadsheet numeric to be selected. Text causes a time/date to appear in the spreadsheet. Spreadsheet numeric displays the number of days since December 30th 1899. The decimal part of the value represents the latest 6 hours, so DDD---DDD.25 represents 0600 hrs, DDD---DDD.5 represents noon etc. Numeric format is more easily interpretable by some spreadsheets than Text format is.

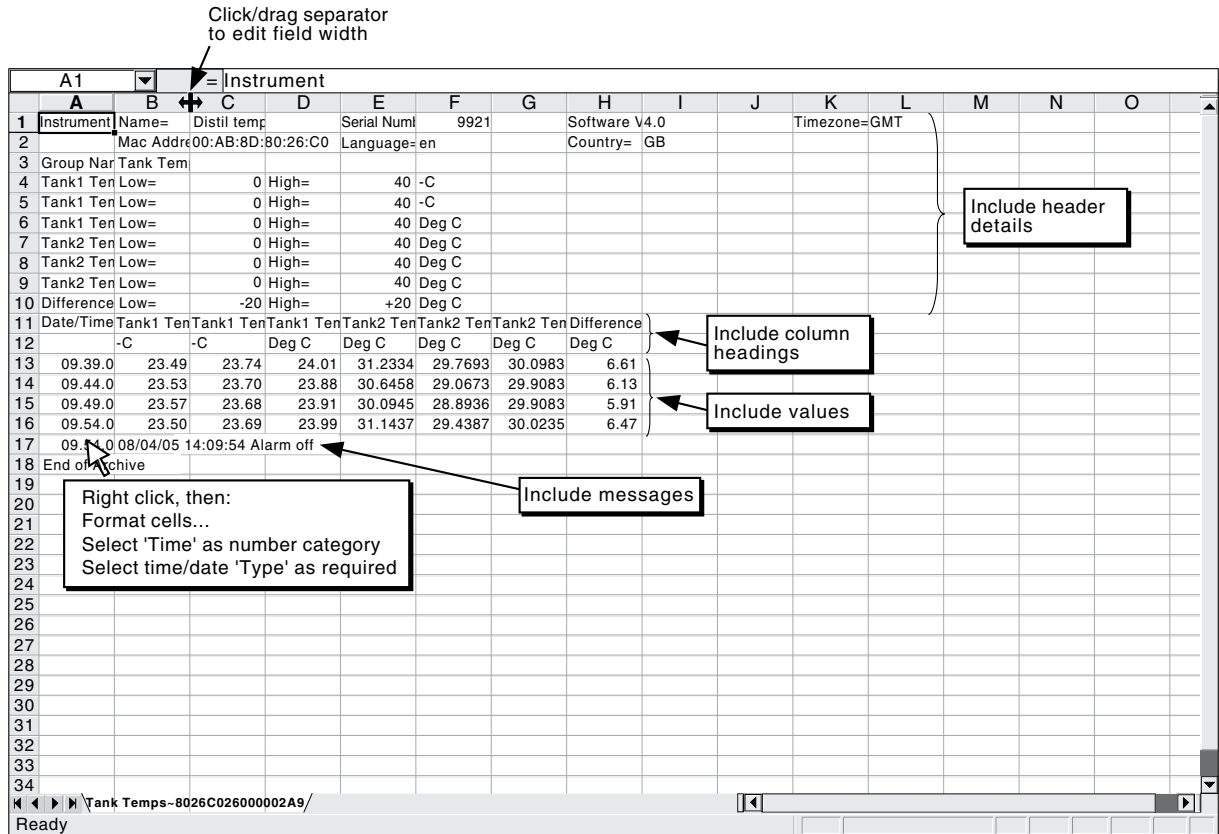

Figure 4.3.5d CSV data example

FTP(S)/FTP FILE FORMAT

The above description for 'Media file format' also applies to 'Remote' setting.

4.3.6 Event configuration

A number of internal and external (Event input option) triggers are available for use in initiating Events which will then run job lists. Events can have up to two sources each, but can themselves be used as sources allowing a large number of inputs to be used. Input sources can be logically combined, and can be inverted if required.

Event Number 1) Event 1 ▼ → Select 1 to 96
 Source 1 Alarm on Group ▼ → Select source 1
 On Group 1) Group 1 ▼ → Make source 1 sub selection (if any)
 Source 2 Point Alarm ▼ → Select source 2
 On Math 12 ▼ → Make source 2 sub selection (if any)
 Alarm 2 ▼ → Make sub-sub selection (if any)
 Source 1 Sense Source 1 ▼ → Select source inversion or not
 Operator And ▼ → Select logic combination: Only, AND, OR, NAND, NOR, XOR.
 Source 2 Sense Not Source 2 ▼ → Select source inversion or not
 Descriptor Event 1
 Job Number 1 ▼ → Select job number
 Category No Action ▼ → Select Job Category

Apply Discard

Figure 4.3.6 Event configuration menu layout (typical)

EVENT NUMBER

Allows the required event (1 to 96) to be selected for configuration.

SOURCE TYPES

Note: Event sources associated with options appear only if those options are fitted.

Off	The event is disabled
Global alarm	The event is active whilst any one or more alarms is active.
Global Unack'd alarm	The event is active as long as there is an unacknowledged alarm present.
Comms channel timeout	The event is set if no communication has been made with 'Comms' channels within the Comms channel timeout period set in Instrument configuration (section 4.3.1). The source is reset when the next communication occurs.
Timer active	The event is triggered when a specified timer (section 4.3.14) becomes active.
Batch Running*	The event is triggered when a batch is started and remains active until the batch stops. If Scope = 'Group' in Batch configuration (section 4.3.10) then a group can be specified. If Scope = 'Instrument', the group select field does not appear. If the Batch option is not fitted, 'Batch running' does not appear in the picklist.
Batch Start*	The event is triggered, fleetingly, when a batch is started. If Scope = 'Group' in Batch configuration (section 4.3.10) then a group can be specified. If Scope = 'Instrument', the group select field does not appear. If the Batch option is not fitted, 'Batch running' does not appear in the picklist.
Event	Allows another event to be specified as a source.
Point alarm	Triggered by the specified alarm on the specified point.
Unack'd point alarm	Triggered by the specified alarm on the specified point. Remains active until the alarm is acknowledged (section 3.1.4).
Alarm on Group	Triggered if any alarm in the specified group becomes active.

(Continued)

* Batch stop also available - see below.

4.3.6 EVENT CONFIGURATION (Cont.)

EVENT SOURCES (Cont.)

Unack'd Alarm on Group	Triggered if any alarm in the specified group becomes active. The event remains active until the alarm is acknowledged.
Instrument alarm	This source triggers an event if any of the following becomes active: Any, Input channel failure, Removable media failure, Removable media full, No removable media fitted, FTP(S)FTP primary server failure, FTP(S) FTP secondary server failure, Maths channel failure, Clock failure, Unrecognised PCCard, Recording failure - overflow, Network not found, SNTP server failure, Time synchronisation failure, Battery backed RAM cleared. See section 3.1.3 for Instrument alarm details. The event remains active until the instrument alarm clears.
Power up	A transient event is triggered at power up.
Maths channel partial failure	For recorders fitted with Maths channels (section 4.3.11), this event is set if, say, one of the inputs to a group averaging function becomes invalid. In such a case, the average will be calculated on the remaining input values, but the result may not be as accurate as expected. Loss of one input can also be important in functions such as Fvalue, where several sensors may be distributed within the load and their outputs used in a group minimum calculation for input into the Fvalue equation.
Battery Low	This event is set when the battery is reaching the end of its useful life. The event remains active until the battery is replaced (see Annex B for details).
Archive media % full	Triggered when the archive medium has reached the % fullness defined in Archive configuration (section 4.3.5).
Invalid Password Entry	Transient event at the point of an invalid password entry attempt
User Login Account Disabled	Transient event at the point when an account is disabled because the number of password re-tries has been exceeded (Section 4.4.2). Available only if the Auditor 21CFR11 option is fitted.
User Logged In	This event becomes active whenever a user with the specified Event Permission logs in. The event remains active until all local and remote users, with the specified permission, have logged out. See also section 4.4.1 (Access levels).
Event Button	Allows the operation of an event button (if Screen Builder option fitted - section 7) to be used as an event source. See section 4.3.7 for Event Button details.
Master Comms Slave Failure	If the Master Comms option is fitted, this event source allows either a communications failure with a specifiable remote device, or communications failure with 'Any' connected remote device to be used as an event source. See section 4.3.16 for more details.
Event input board	If one or more Event Input option boards are fitted, this allows a contact closure or negative going voltage signal to be used as an event source. The required input is defined by specifying a Board number and an Input number. Refer to Section 10 for more details. The menu item does not appear if Event input boards are not fitted.
Email Failure	Triggered if an attempt to send an e-mail (section 4.3.19) is unsuccessful.
Batch Stop	The event is triggered, fleetingly, when a batch is stopped. If Scope = 'Group' in Batch configuration (section 4.3.10) then a group can be specified. If Scope = 'Instrument', the group select field does not appear. If the Batch option is not fitted, 'Batch Stop' does not appear in the picklist.

SOURCE 1 SENSE

Allows source 1 to be used in its normal sense (Select 'Source 1') or inverted (Select 'Not Source 1').

Example: Source 1 is alarm 1 on channel 3

With Source 1 Sense = Source 1, the event is active whenever channel 3 alarm 1 is active.

With Source 1 Sense = Not Source 1, the event is active whenever the alarm is not active.

4.3.6 EVENT CONFIGURATION (Cont.)

OPERATOR

This allows a logical combination of input sources to be used to trigger an event. The selections and their definitions are shown in table 4.3.6, below.

Operator	Event active when:	Event not active when:
Only	S1 Active	S1 not active
AND	S1 and S2 both active	S1 and/or S2 not active
OR	S1 and/or S2 active	S1 and S2 both not active
NAND	S1 and/or S2 not active	S1 and S2 both active
NOR	S1 and S2 both not active	S1 and/or S2 both active
XOR	S1 or S2 active	S1 and S2 both active or both not active
S1 = Source 1; S2 = Source 2		

Table 4.3.6 Logical operators for event sources

SOURCE 2 SENSE

Allows source 2 to be used in its normal sense (Select 'Source 2') or inverted (Select 'Not Source 2').

Example: Source 2 is Group 1 Batch Running

With Source 2 Sense = Source 2, the event is active whilst the batch is running.

With Source 2 Sense = Not Source 2, the event is active whilst the batch is not running.

DESCRIPTOR

Allows a text string to be entered as the event title. See [section 3.3.2](#) for text entry techniques.

JOB NUMBER

Select the required job number for this event.

CATEGORY

Select the required job to be carried out when the channel is in alarm (e.g. Drive relay) See [section 4.7](#) for a description of job categories.

WHILE/ON

Allows the action of the alarm job to be chosen as

- a. while active, while inactive or while unacknowledged for continuous jobs (e.g. drive relay), or,
- b. on going active, on going inactive or on acknowledgement for 'one-shot' jobs (e.g. increment counter).

See also [figure 4.3.3g](#) and associated text.

EVENT EXAMPLE

An event is to be active whenever Channel 1 Alarm 1 is active whilst Channel 3 alarm 2 is not active.

Source 1 = Point alarm (On = Channel 1; Alarm = 1)

Source 2 = Point alarm (On = Channel 3; Alarm = 2)

Source 1 Sense = Source 1

Operator = And

Source 2 Sense = Not Source 2

It is possible to achieve the same result by inverting both Source senses and using the Nor operator.

4.3.7 Event Buttons

This configuration item appears only if the Screen Builder Option is fitted (section 7).

The Event Button configuration menu allows a number of 'Push-Buttons' to be set up for use as event sources. Buttons can be defined as 'Unlatched' (push = on; release = off) or 'Latched' (push once = on; push again = off etc.).

Note: Unlatched button action occurs when the button is released.

Unlatched types have a single text string associated with them. Latched types have two text strings, one for the 'On' (latched) state; the other for the 'Off' state. Figure 4.3.7 shows the configuration menu.

Event buttons are independent of the Security Management option, described in section 4.4.2. This allows individual buttons to be a) entirely open to the user, b) to require signing, or c) to require both signing and authorization, as required.

The screenshot shows a configuration window with the following fields and options:

- Button Number:** 1) Button 1 (dropdown menu, range 1 to 96)
- Descriptor:** Button 1 (text input)
- Type:** Latched (dropdown menu, options: Latched or Unlatched)
- Text:** Off Text (text input, for unlatched buttons)
- Latched Text:** On Text (text input, for latched buttons)
- Require Signing:**
- Require Authorisation:**
- Buttons:** Apply, Discard

Figure 4.3.7 Event Button option configuration menu

Button number	Allows selection of the button (1 to 96) which is to be configured.
Descriptor	Allows a button name, of up to 20 characters, to be entered.
Type	Select Latched or Unlatched, as defined above.
Text	For unlatched buttons, this allows entry of the legend which is to appear on the button when displayed. For latched buttons, this is the legend which appears when the button is in its non-active (off) state.
Latched Text	This field appears only if Type = Latched, and allows entry of the legend which is to appear on the button when in its active (on) state.
Require Signing	If this field is enabled, then the button can be used only by those whose 'Can Sign' permission is enabled in the 'Access' menu described in section 4.4.1. When the button is operated in the User screen, a 'signature' page appears which requires the entry of the correct password for the selected user, and of a note which would normally be used to give the reason for the operation.
Require Authorisation	This field appears only if 'Require Signing' is enabled. If Require Authorisation is enabled, then the button can be used only by those whose 'Can Authorize' permission is enabled in the 'Access' menu described in section 4.4.1. When button operation is attempted, a 'signature' page (figure 4.4.2b) appears which requires the entry of the correct password for the selected user, and a note which would normally be used to give the reason for the change.

Notes:

- 'Require Signing' and 'Require Authorisation' appear only if the Auditor 21CFR11 option is fitted.
- If the Auditor 21CFR11 option is fitted, a message appears on the chart after authorization and/or signing are complete. The example below shows the message when both Signing and Authorisation are enabled.

DD/MM/YY HH:MM:SS Button Descriptor,Signed:Engineer,Authorised:Engineer,Note

4.3.8 Messages

This feature allows messages to be sent, by job action (section 4.7), to the display, to a specified group or to all groups. Messages can also be included in e-mails (section 4.3.19). The messages are of the form: Date, Time, Message. The message can be just text (up to 80 characters), or it can include up to nine embedded items which are typed into the message as {1} to {9}. The embedded values represented by {1} to {9} are selected from picklists.

If a Group-destination message contains more characters than can be displayed on the screen (depends on recorder model), the right-hand part of the message is invisible to the user. The message appears in full in the message log (section 3.1.4) and when Review Software is used. Display-destination messages are always fully visible.

MESSAGE ENTRY

The message configuration page is shown below in figure 4.3.8 The page is accessed from the Root menu/Operator/Config menu.

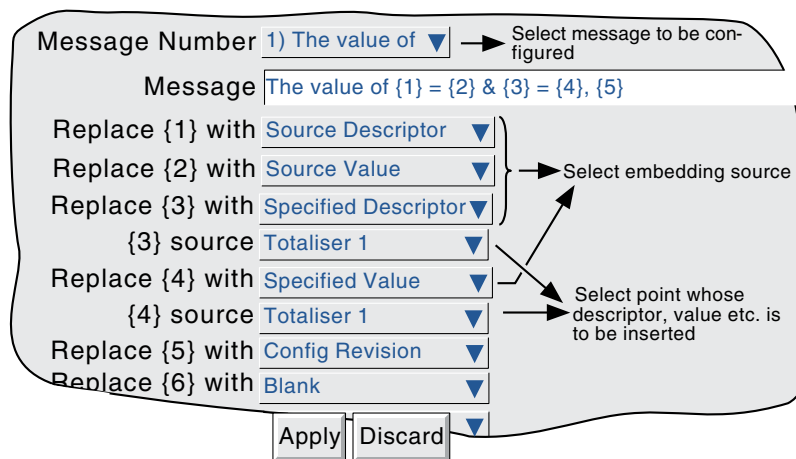

Figure 4.3.8 Message entry configuration page.

CONFIGURABLE PARAMETERS

- Message Number Select the required message from the picklist.
- Message Enter the message by using the pop-up keyboards (section 3.3.2)
- Replace {n} with A picklist allowing the user to select data to be embedded in the message:
 - Source Descriptor: The descriptor of the source which triggers the job message.
 - Source Value: The instantaneous value of the source at trigger time.
 - Source Alarm Data: Details (see table 4.3.8) of the source alarm at message trigger time.

Alarm Type	Embedded details
Absolute	Enable, Type (high or low), Threshold, Status
Deviation	Enable, Type (in or out), Reference, Deviation, Status
Rate of change	Enable, Type (rise or fall), Amount, Change time, Status

Table 4.3.8 Alarm details versus alarm type

Note: If any of 'Source Descriptor', 'Source Value' or 'Source Alarm Data' are embedded in a message which is triggered by a job which cannot be associated with a specific source (e.g. event, timer), then the embedded value will be: ?????.

(Continued)

4.3.8 MESSAGES (Cont.)

Replace {n} with (Cont.)

Specified Descriptor, Specified Value, Specified Alarm data: Produces a further field '{n} source', described below.

Batch Status: Causes the status ('Active' or 'Inactive') of the current batch to be embedded. See [Section 4.3.10](#) for details of the Batch option.

Batch Field data: Allows a selected batch field to be included in the message. If a batch is not running at the time the message is triggered, the Batch field data is replaced by '?????'. See [Section 4.3.10](#) for details of the Batch option.

Note: Group number must be entered if the batch is configured for Group mode.

Instrument Name: Allows the Instrument Name (as entered in Configuration/Instrument - [section 4.3.1](#)) to be included in the message.

Instrument Number: Causes the instrument number (Network/Address - [Section 4.5.1](#)) to be embedded.

Config Revision: Embeds the Config File Version number (System/About - [section 4.6.11](#)) in the message

Local User: Embeds the currently logged-in user (e.g. 'Engineer', 'JohnW', etc.)

{n} source

This field appears only if the previous field (Replace {n} with) is selected as 'Specified Descriptor', 'Specified Value' or 'Specified alarm data'. The associated picklist(s) allow a specific point, and a specific alarm (if appropriate) to be selected. It is thus possible to configure, say alarm 1 on channel 2, to produce a message giving the descriptor and/or value of, say, totaliser 1.

Notes:

1. n = 1 to 9
 2. The example below is intended to clarify message entry techniques.
-

4.3.8 MESSAGES (Cont.)

EXAMPLE

To configure Message 2 to read "The value of Chan two = (Value channel 2) & Tot one = (Value totaliser 1)"

Before configuring the message:

In channel configuration:

Set channel 2 descriptor to: Chan two

Set Channel 2 alarm job to:

Category: Message

Send message(s) to: All Groups

First message: 2) Message 2

Last Message: 2) Message 2

On: Active

In Totaliser configuration:

Set Totaliser 1 descriptor to: Tot one

In Messages configuration:

1. Select Message 2.
2. Access the Symbols keyboard ([section 3.3.2](#)) and enter, without spaces, {}={}&{}={}
3. Access the Numeric keyboard and insert 1, 2, 3, 4 within the braces to give: {1}={2}&{3}={4}
4. Access the Alphabet keyboard, and insert text and spaces: The value of {1} = {2} & {3} = {4}
5. Set 'Replace {1}' to "Source Descriptor"
6. Set 'Replace {2}' to 'Source Value'
7. Set 'Replace {3}' to 'Specified Descriptor'
8. Set '{3} source' to Tot one
9. Set 'Replace {4}' to 'Specified Value'
10. Set '{4} source' to 'Tot one'

The result of this is that, should the channel 2 alarm go active, the following message would be sent to all groups, appear on the 'chart' and become part of all groups' histories:

18/10/01 11:19:58 The value of Chan two = 6.0°C & Tot one = 3383.8073 Units

Note: On some models, the message may be wider than the screen. If necessary, the message can be shortened (e.g. use 'Ch2' instead of 'Chan two'), or it can be viewed in full, either in Message log, ([section 3.1.4](#)) or by using [Review Software](#), if available.

4.3.9 User Linearisation Tables

The Channel configuration item 'Lin Type' includes 12 linearisation tables called, initially, UserLin1 to UserLin12. This User Linearisation part of the instrument configuration allows the user to enter linearisation look-up tables of between two and 66 pairs of points.

The pairs of points are entered as X1Y1, X2Y2... ..XnYn,

where 'n' is the specified number of points.

X1 to Xn represent the inputs to the function.

Y1 to Yn represent the corresponding outputs from the function.

Notes:

1. Each Y value must be unique - i.e. there cannot be more than one X value with the same Y value assigned to it.
2. Each X value (other than the first) must be greater than the previous one.
3. Each Y value (other than the first) must be greater than the previous one.
4. To specify units other than temperature units, the channel 'scaled' facility must be used. The scale low/high values should be set to be the same as the range low/high values, and the required units entered

The import/export Linearisation tables feature described in 'Save/Restore' (section 4.2) offers an alternative way of entering linearisation tables.

Figure 4.3.9a shows the default configuration page. Figure 4.3.9b shows a simple table for relating water depth to water volume for a cylindrical tank with a conical bottom.

User Linearisation 3) UserLin3▼

Descriptor UserLin3

Format Numeric ▼ → Select Numeric or Scientific

Number of Points 2

X1 0

Y1 0

X2 1

Y2 1

Apply Discard

Figure 4.3.9a User linearisation configuration page

CONFIGURATION PARAMETERS

User Linearisation	Allows a user linearisation table to be selected for configuration.
Descriptor	Allows the user to enter a name of up to 20 characters (including spaces) for the table.
Format	This allows the point pair values to be entered as normal numeric values (Numeric) or in 'Scientific' format (Scientific). When 'Scientific' is selected, values are displayed and entered as a decimal number between 1 and 10† (the mantissa), followed by a multiplier (the exponent). E.G. to enter a value of 1244.5678, the value entered would be 1.2445678E3, where 3 represents the number of places that the decimal point has been shifted to the left in order to convert the value to a number between 1 and 10†. To enter a value of 0.0004196, the entry would be 4.196E-4. Figure 4.3.9b, below, gives further examples.

† Notes

1. Strictly this is a number less than 10, as 10 would be 1.0E1.
2. There must be at least one number after the decimal point.

4.3.9 USER LINEARISATION TABLES (Cont.)

CONFIGURATION PARAMETERS (Cont.)

- Number of points This is used to enter the total number of point pairs in the table. The following XY fields increase in number up to the entered value. (A scroll bar appears if there are more points than can be displayed in the available screen height.)
- X1 to XN The input values to the table, where N is the 'Number of Points' entered above.
- Y1 to YN The resulting, corresponding output values from the look-up table.

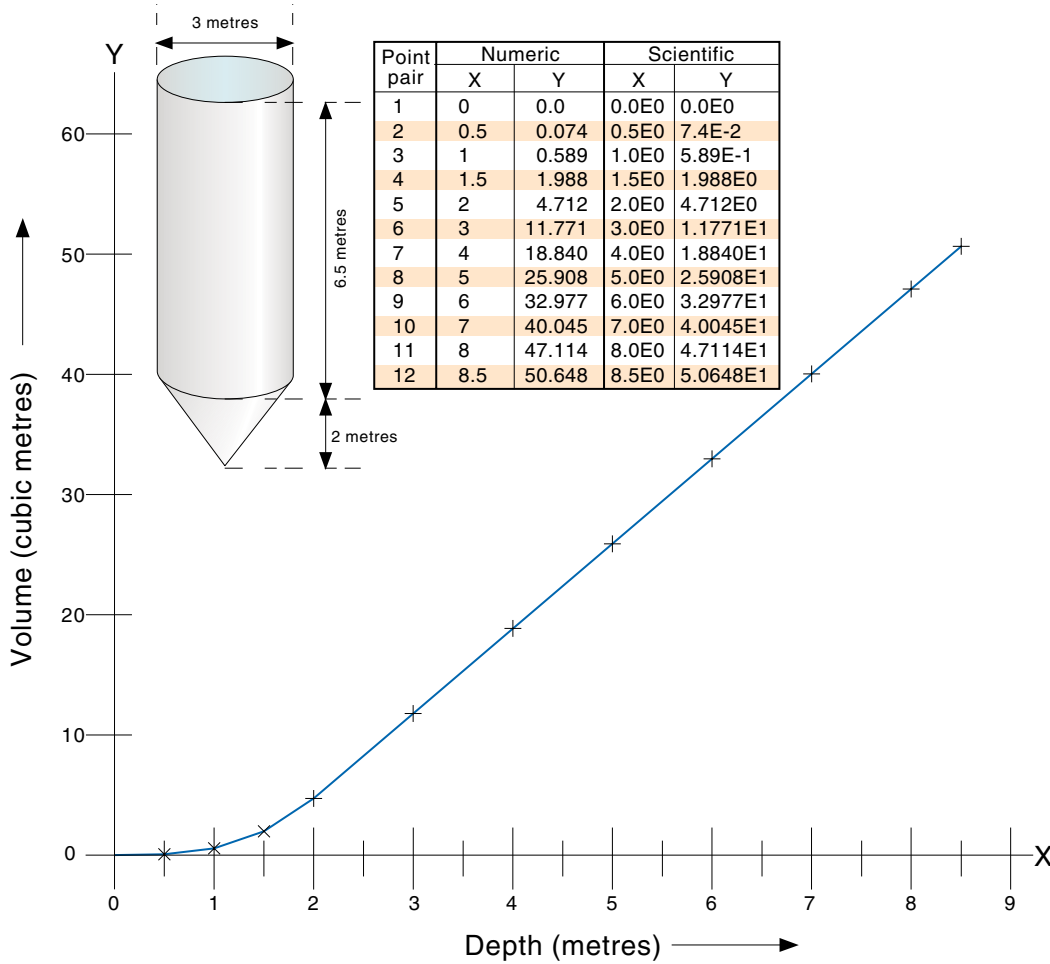

Figure 4.3.9b Sample User Linearisation table.

4.3.10 Batch recording option

Batch records form a part of recording history and are included in the normal archiving process to a removable SD or Compact Flash card or to a remote PC ([sections 4.1](#) and [4.3.5](#)). Batches can be initiated directly by the operator (if access permission is granted), automatically whenever a specified counter changes value, by job or remotely via MODBUS/TCP.

Batches can be defined as start/stop, or continuous and can incorporate all channels, or just those associated with a specified Group. For start/stop batches, the batch record starts when the batch is started, and continues until it is stopped. For continuous batches, the batch record starts when the batch is started and continues until the next batch is started, or until batch recording is disabled.

When using 'PC review' software the 'Go to Batch' feature can be used to select a particular batch record.

If 'Name files by Batch' is enabled a separate history file is created for each batch.

For each batch start, a start message is printed:

```
DD/MM/YY HH:MM:SS Batch start (User Full Name)
```

Where DD/MM/YY is the date, HH:MM:SS is the time, and User Full name is either the current user name, the security level (e.g. Engineer) or 'Automatic' if the batch has been initiated by job, or 'Modbus' if triggered remotely. A similar message is printed at Batch Stop. (There are no stop messages associated with continuous batch selection).

In addition to the above start/stop messages, up to six lines of text can, if required, be printed on the 'chart' at the start of a batch and, if required, at the end of a batch. The messages are in two parts, which for the sake of this document, are called 'Headings' and 'Values'. The Headings are entered in Fields 1 to 6 in Batch Configuration. The Values associated with these headings are entered by the operator at initiation.

AUDITOR MESSAGES

If either [Auditor](#) option is fitted a Config/Security Revision message appears immediately after the Batch Start message:

```
DD/MM/YY HH:MM:SS Config Revision:NNNNNN Security Revision:SSSSSS
```

```
DD/MM/YY HH:MM:SS Batch start (User Full Name)
```

BATCH SUMMARY

A Batch Summary page can be displayed from the Summary menu described in [section 3.1.4](#), above.

THERMAL UNIFORMITY SURVEY (TUS)

Certain aspects of the batch operation are affected by the TUS option. In particular, the operator can be made to carry out an input adjust procedure before the batch starts, after it finishes, or both. Full details are to be found in [section 15](#).

4.3.10 BATCH RECORDING OPTION (Cont.)

CONFIGURATION

The screenshot shows the Batch configuration menu with the following settings:

- Scope: Group (dropdown menu)
- Group: 1) Group 1 (dropdown menu)
- Show Batch Entry List: (checkbox)
- MAC Address: 00:0A:8D:00:20:A0 (text field)
- Predefined Entry 1: FishesRus (text field)
- Predefined Entry 12: (empty text field)
- Enable: (checkbox)
- Batch mode: Start/Stop (dropdown menu)
- Batch Fields: 4 (dropdown menu)
- Field 1: Batch Number: (text field)
- Batch field 1: Use Counter (dropdown menu)
- Counter: Counter 1 (dropdown menu)
- Field 2: Customer Name: (text field)
- Field 3: Operator Name: (text field)
- Field 4: Supervisor: (text field)
- On start log: 4 (dropdown menu)
- On stop log: 1 (dropdown menu)
- On new clear: 1 (dropdown menu)
- Name files by batch: (checkbox)
- Pre calibration: (checkbox)
- Post calibration: (checkbox)

Annotations in the image:

- Arrows point from the 'Scope' and 'Group' dropdowns to the text: "Select Instrument or Group" and "Appears only if Scope = 'Group'".
- An arrow points from the 'Show Batch Entry List' checkbox to the text: "These fields appear only if 'Show Batch Entry List' is enabled".
- An arrow points from the 'Batch field 1' dropdown to the text: "Select Counter or Text".
- An arrow points from the 'Counter' dropdown to the text: "Select Counter (Appears only if 'Use Counter' selected)".
- An arrow points from the 'Pre calibration' and 'Post calibration' checkboxes to the text: "Appear only if 'TUS' option enabled".

Buttons at the bottom: Apply, Discard.

Note: See section 15 for details of the TUS option.

Figure 4.3.10a Batch configuration menu

As depicted in figure 4.3.10a, the following configuration entries can be made:

SCOPE

Allows the user to define all configured channels (instrument) or just those in a particular group, for batch control. If 'Group' is selected, a further picklist appears allowing a specific group to be selected.

SHOW BATCH ENTRY LIST

Enabling this field produces a list of 13 entries which can be used as field entries when starting or storing a batch (as described in 'Operator initiation', below). The first entry is the MAC address of the recorder and is not editable. The remaining 12 entries (of up to 60 characters each) are freely editable. This is a different list from that entered (for [Operator notes](#)) in Instrument configuration ([section 4.3.1](#)).

ENABLE

Allows the batch function to be switched on or off.

BATCH MODE

Allows batch mode to be selected as Continuous or Start/Stop.

4.3.10 BATCH RECORDING CONFIGURATION (Cont.)

BATCH FIELDS

Allows the number of messages to be printed at batch start/stop to be selected between one and six.

FIELD 1

This field is the first of up to six which can be used as headings for batch information. Headings can be up to 20 characters long (including spaces). In the example shown in Figure 4.3.10a, Heading 1 (Field 1) has the entry 'Batch Number:'. When initiating the batch, the operator has to enter a value to be associated with this heading (see below), unless 'Use Counter' is selected in the following 'Batch Number' field.

BATCH NUMBER

This allows the Value entered for Field 1's heading to be selected as 'Use Text' or 'Use Counter'.

USE TEXT	When Text is selected, the value for field 1 is entered by the operator on initiation of the batch.
USE COUNTER	When Counter is selected, a further field appears ('counter') allowing a specific counter to be selected from a picklist. The selected counter initiates a new batch whenever it changes value, and the counter value is appended to the text associated with Field 1 (but see note 2). See section 4.3.13 for details of counters.

Notes:

1. Start batch is initiated on any change in counter value - not just increment.
 2. It is recommended that when 'Use Counter' is selected, then only counter 1 be used as the batch initiator. Other counters may be selected, but operation is not guaranteed.
-

FIELDS 2 TO 6

Fields 2 to 6 are also used as headings for batch information. Values for these headings must be entered by the operator prior to Batch initiation. See also 'On new clear', below. Headings can be up to 20 characters long (including spaces).

ON START LOG

This defines how many of the selected Fields are to be printed at batch start. An entry of '1' means that only Field 1 will be printed. An entry of '2' means that Fields 1 and 2 will be used, and so on. An entry of 0 means that only the 'Batch Start' message will be printed. It is not possible to print only, say, Field 3. If Field 3 is required, it must be preceded by Fields 1 and 2.

ON STOP LOG

As for On start log, above, but for batch stop. This item appears only if Start/Stop is selected as batch mode.

ON NEW CLEAR

For 'Use Text' Batches only, this allows the user to clear none or more of the batch entries at each batch start. In the example above, if the user enters a batch number of say 050825.001, with Customer Name: FishesRus, Operator name: Marvin, Supervisor: Fred, then setting 'On New Clear' to '1', causes the batch number to be cleared, and to have to be re-entered, each time a new batch is started.

In a similar way, setting 'On New Clear' to '2' means that the batch number value and the Customer Name: value to be cleared. A new batch cannot be started without new values first being entered.

4.3.10 BATCH RECORDING CONFIGURATION (Cont.)

NAME FILES BY BATCH

As an aid to identification, if 'Name Files by Batch' is selected, the Batch Name, as entered by the operator, is inserted into the history file name. For example, if a batch name of 060511.001 is amongst the items archived to disk, then this file will appear in the form:

Group Name~060511.001~YYYYMMDD_HHHHHHHHHHHHHHHHHH,

Where YYYYMMDD is the date (e.g.20060511 = 11th May 2006) and HH---HH is a 16 digit hex code* used by the recorder and by review software to identify the file. If name files by batch is not selected, the Batch name is not included, and the file appears as:

Group Name~YYYYMMDD_HHHHHHHHHHHHHHHHHH,

*The HHH--HHH code contains the following information:

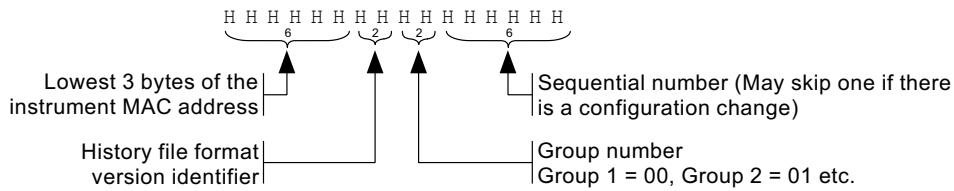

PRE CALIBRATION

This item appears only if the TUS option is fitted. When enabled, the user must carry out an input adjust procedure prior to batch start. If Audit Trail is enabled, messages appear on the chart for each channel adjusted:

05/10/10 11:22:09 1) Channel 1 Pre cal high 4.998, Post cal high 5.000
 05/10/10 11:22:00 1) Channel 1 Pre cal low 0.998, Post cal low 1.000

POST CALIBRATION

As above, for Pre calibration, but when enabled, the adjust procedure must be carried out on batch stop.

4.3.10 BATCH RECORDING CONFIGURATION (Cont.)

OPERATOR INITIATION

If the TUS options is fitted - see [section 15](#).

This section describes how the operator initiates a new batch. Batches can be initiated from any of the trend, bargraph or numeric display modes, but the start/stop and other messages appear only on the Vertical Trend screen, in the trend history display and in Message Log. Batch information and status are retained whilst power is off.

To initiate a batch, either

1. Operate the Option key, then press 'Batch' in the Option Menu* which appears, or
2. Touch the coloured message area at the top of the screen. The batch Status page appears - in this example - with no batch running.
3. Press 'New'. A new display page appears (figure 4.3.10b), showing all the headings entered in Field 1 to Field 6 during configuration. If the Batch Fields entry is less than 6, then only the selected number appear (in our example, 4).

***Notes:**

1. The option menu is context sensitive, so its appearance may differ from the example shown.
2. Batches can also be started and stopped from the Batch Summary page as described in [section 3.1.4](#).

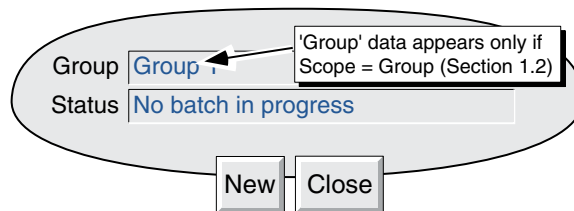
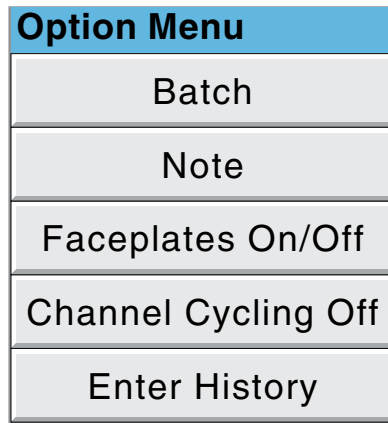

4.3.10 BATCH RECORDING CONFIGURATION (Cont.)

OPERATOR INITIATION (Cont.)

'Values' can now be entered for these headings by entering strings of up to 60 characters (including spaces).

This may be done by touching the empty field and using the resulting pop-up keyboard to type-in the entry, or by touching the field continuously for two seconds or more and then selecting one of the predefined Batch Entry messages previously entered in the configuration page. In the latter case, the predefined message may be edited in the normal way before being Applied. Such editing has no effect on the original message.

Once the entries are complete, operation of the Start button initiates batch recording. Operation of the Store button saves the configuration for later initiation by job, by counter or via MODBUS/TCP.

The Values entry page is replaced by the batch status page (figure 4.3.10c), this time showing details of the batch in progress. This page allows the batch to be stopped or a new one triggered.

Note: Text may also be entered using a suitable keyboard connected via the USB port behind the access flap or (if the relevant option is fitted) one of the USB ports at the rear of the instrument (section 2.2).

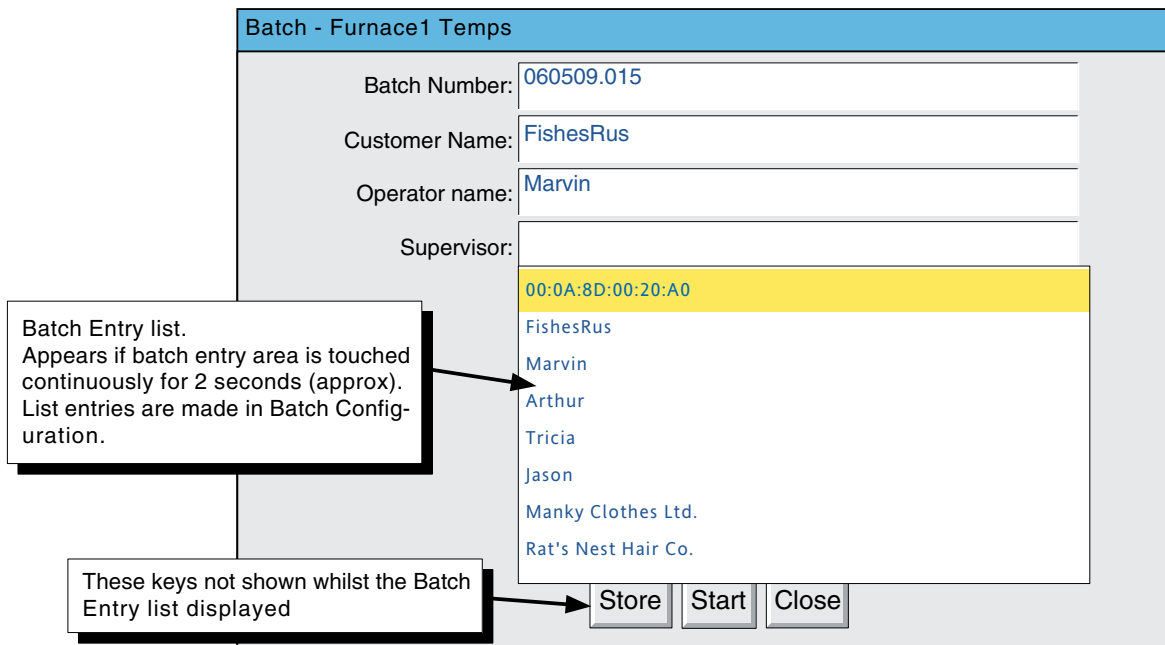

Figure 4.3.10b Batch values entry page

4.3.10 BATCH INITIATION (Cont.)

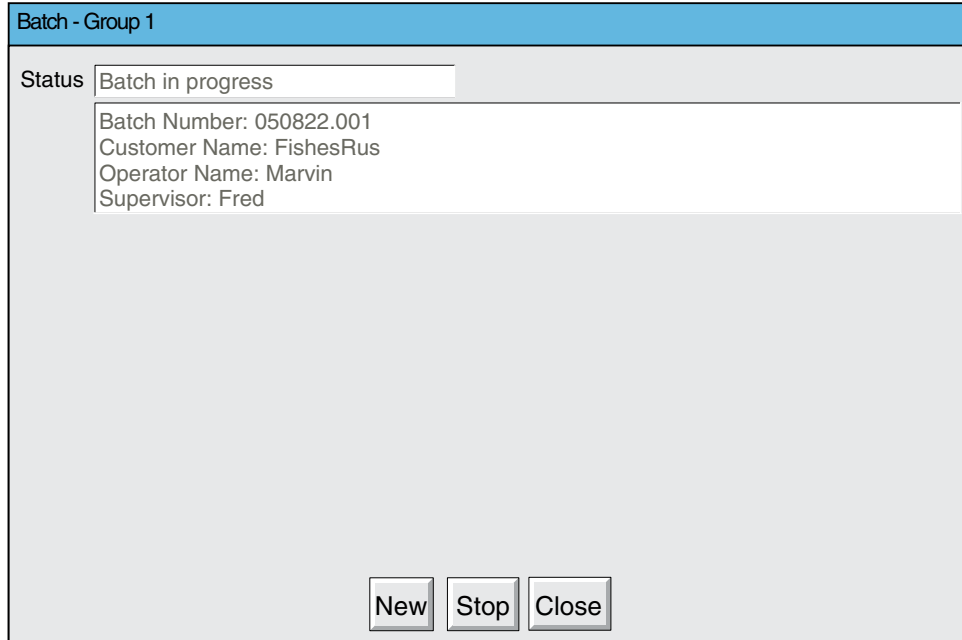

Figure 4.3.10c Status page (Batch running)

BATCH MESSAGE DISPLAY

The messages are displayed on the Graph Trend display as shown in figure 4.3.10d, below. This figure uses the example given in the previous sections, and uses only four messages. Further messages would appear above message 4. The figure also shows that time and date are added to the messages, and that the currently running batch number is given in the Group name area. Touching this area calls the Batch status page. In this job-triggered batch, the alarm triggering the job also appears (as shown).

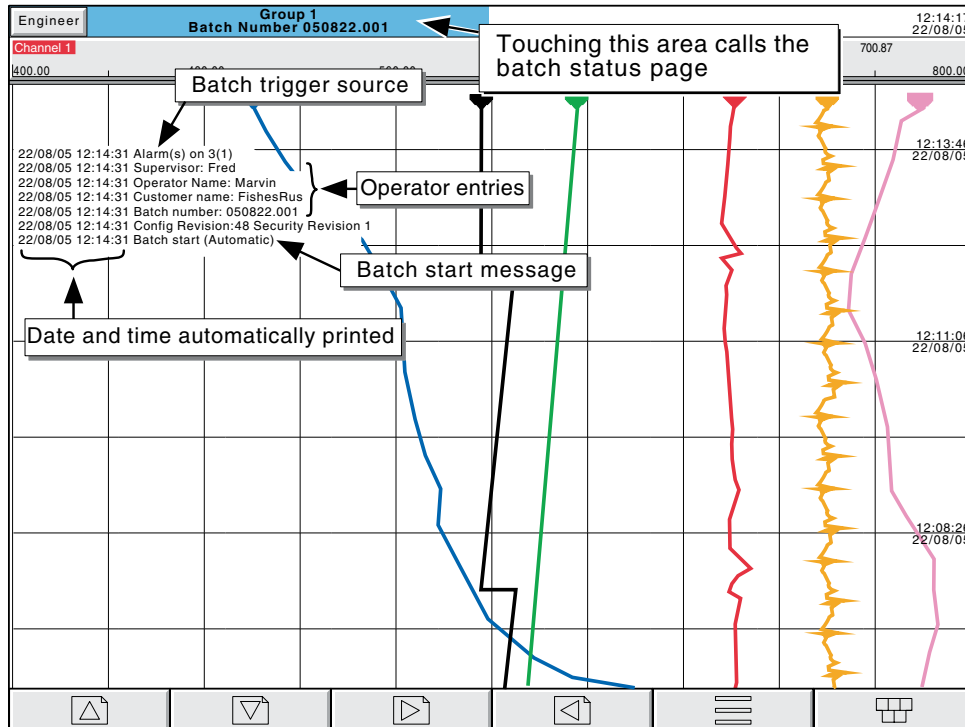

Figure 4.3.10d Typical Batch start messages

4.3.10 BATCH INITIATION (Cont.)

NON OPERATOR INITIATION

Batch start/stop can be initiated by job, by counter or via MODBUS/TCP

JOB INITIATION

As described in [section 4.7.9](#), a job can be set up to initiate a batch whenever the job source becomes active. If 'Scope' is set to 'Group' a specific group can be selected (default = Group 1) and the job will act only on the batch associated with this group. Batch 'Start' jobs automatically start the batch using the entries made during the 'Store' function, described above. 'Display Batch Dialog' jobs allow the user to enter the field values manually, before the job starts.

COUNTER INITIATION

If Batch Number is selected as 'Use Counter', then a new batch will automatically be started whenever the selected counter changes value (increment, decrement or preset). The new value of the counter is used as the value associated with Field 1.

For the other fields to have values printed on the chart, these must have been entered as described above for Operator initiation, then the 'Store' button touched.

The 'On new clear' setting is ignored, the stored values being used each new batch.

Batch start messages are of the form:

DD/MM/YY HH:MM:SS Batch start (Automatic)

Batch recording cannot be stopped by Counter action.

MODBUS INITIATION

In order to initiate batch recording via MODBUS/TCP, a Batch Start flag has to be set (value = 0001). For Scope = Group, the flag for the specified group must be set. For Scope = Instrument any group's Batch Start flag may be used.

The address of the flag for group 1 is decimal 42364; the address for group N is $\{42364 + 629(N-1)\}$

For further details of the Modbus TCP option see section 8.

If Batch mode = Start/Stop, batches can also be stopped via MODBUS. The address for group 1 is 42365; the address for group N is $\{42364 + 629(N-1)\}$. Again the value must be set to 0001.

Modbus start messages are of the form:

DD/MM/YY HH:MM:SS Batch start (Modbus)

Stop messages are similar.

EVENT SOURCES

As described in [section 4.3.6](#), 'Batch Start', 'Batch Running' and 'Batch Stop' can be selected as event sources. If 'Scope' = 'Group' in Configuration (described above), then the user can select which group's batch is to be used as the event source.

4.3.11 Maths

CONFIGURATION

This feature allows a range of mathematical functions to be performed. Figure 4.3.11a shows a typical configuration page - the selected maths function determines which configuration fields actually appear.

The screenshot shows a configuration menu for a maths function. The fields and their values are as follows:

- Maths Number: 1) Fo 1 (dropdown)
- Value: 32.65 (text input)
- Function: fValue (dropdown)
- Fvalue of: Channel 1 (dropdown)
- Sterilizing Temp: 121.1 (text input)
- Temperature interval: 10 (text input)
- Low cut off: 75 (text input)
- Units: Mins (text input)
- Descriptor: Fo 1 (text input)
- A/B Switching: (checkbox)
- Scale Low: 0 (text input)
- Scale high: 60 (text input)
- Zone low: 0 (text input)
- Zone high: 100 (text input)
- Scale Type: None (dropdown)
- PV Format: Numeric (dropdown)
- Max Decimal Digits: 2 (text input)
- Colour: 26 (text input)
- Alarm Number: 1 (dropdown)
- Enable: Off (dropdown)
- Job Number: 1 (dropdown)
- Category: No Action (dropdown)

Buttons: 'Reset now', 'Apply', and 'Discard'. Annotations include: 'Select maths channel number' pointing to Maths Number; 'Current value' pointing to Value; 'Reset button appears only for resettable functions' pointing to the Reset now button; 'Select Required maths function' pointing to Function; 'Select Source input' pointing to Fvalue of; 'Select None, Linear or Log' pointing to Scale Type; 'Select Numeric, Elapsed Time, Scientific, Time or Date' pointing to PV Format; 'Select Alarm number' pointing to Alarm Number; 'Select: Off, Unlatched, Latched or Trigger' pointing to Enable; and 'Select Job number' pointing to Job Number.

Figure 4.3.11a Maths configuration menu (typical - varies from function to function)

MATHS NUMBER

Allows the user to select the required maths channel for configuration. The maximum number of maths channels is selected in the Virtual channels section of the Configuration/Options display, described in [section 4.3.22](#).

VALUE

This field shows the current value of the selected maths channel. If the channel has not yet been configured, the value reads 'Off'.

RESET NOW

This button appears only after a resettable function has been selected. Operation of the button sets the maths value to zero.

4.3.11 MATHS CONFIGURATION (Cont.)

Function

This picklist allows the relevant maths function to be selected. In the following description, the word 'channel' is used as an umbrella term for input channels, maths channels, totalisers etc.

Off	Allows the function to be disabled. Once 'Apply' has been actioned, all configuration for this Maths number is lost.
Constant	Allows a maths channel to be set to a constant value.
Add	Allows any channel or a constant value to be added to any other.
Subtract	Allows any channel or a constant value to be subtracted from any other.
Multiply	Allows any channel or a constant value to be multiplied by any other.
Divide	Allows any channel or a constant value to be divided by any other. Should the value of the divisor pass through zero, 'Maths Channel N error' and 'Maths Channel Failure' messages appear.
Group average*	The instantaneous value of all the channels in the source group added together and divided by the number of channels in the group. For example, in a group of four channels whose instantaneous values are 4, 8, 2 and 6, the group average is $(4 + 8 + 2 + 6) / 4 = 5$. The relevant source group is selected by picklist. Should a channel return a non-valid value, it is excluded from the calculation, and the result of the function is the average of the remaining channels.
Group minimum*	The lowest value of any of the channels in the source group. For example, in a group of four channels whose instantaneous values are 4, 8, 2 and 6, the group minimum is 2. The required source group is selected by picklist. Should a channel return a non-valid value, it is excluded from the calculation, and the result of the function is the minimum of the remaining channels.
Group maximum*	The highest value of any of the channels in the source group. For example, in a group of four channels whose instantaneous values are 4, 8, 2 and 6, the group maximum is 8. The required source group is selected by picklist. Should a channel return a non-valid value, it is excluded from the calculation, and the result of the function is the maximum of the remaining channels.

*Note:

If a maths channel with a Group function is contained within its own source group, then it will act on itself as well as on the other group contents, thus changing the calculation. For example, if Group 1 were to contain channel 1, channel 2 and maths channel 1, where maths channel 1 had the function 'Group Maximum' for Group 1, then the Group Maximum would become a latching function, showing the highest value ever reached by channel 1, channel 2 or maths channel 1 since the group was configured. In order to trace the instantaneous highest value, channel 1 and channel 2 would have to be contained in e.g. Group 1, and the group maximum channel contained in, say, Group 2, but with a source of 'Group 1'.

Modbus Comms input	Allows Modbus communications to be selected for reading values from slave instruments - see section 4.3.15. If virtual channels are used - see section 4.3.22.
Ethernet/IP Comms Input	Allows Ethernet/IP communications to be selected for reading values from client instruments - see section 4.3.21.
Stopwatch	This causes the value of the maths channel to increment in milliseconds. The value can be displayed in milliseconds (PV format = numeric), or in HH:MM:SS (PV format = elapsed time). The value can be held, using a 'Disable' job or set to zero either using a 'reset' job or by the operation of the 'Reset now' button in the maths configuration page. See section 4.7 for a description of jobs. The function value is retained during power off.

Note: The scale low and high values are displayed in numeric format for both numeric and elapsed time display formats

4.3.11 FUNCTION (Cont.)

Copy	Copies the value of a selected point to the maths channel being configured. Allows extra alarms to be set up for the copied point.
Polynomial Fvalue	Provides a polynomial curve fit for the specified point, using up to 8 orders. This function calculates 'equivalent time at sterilizing temperature' for temperatures above and below the sterilizing temperature. FO (dry) and FH (steam) sterilizing calculations can be carried out, by entering the correct constant. The value can be held, using a 'Disable' job or set to zero (prior to the next run) using a 'reset' job. See section 4.7 for a description of jobs. The function value is retained during power off.
Switch	Allows two channels ('A' and 'B') to be selected as alternative sources for the selected maths channel to copy. The maths channel copies source 'A', unless a 'Switch to B' job is active on the maths channel. See section 4.7 for Job descriptions.
Linear Mass Flow	This function calculates mass flow from linear-type transducer outputs.
Root Mass Flow	This function calculates mass flow from square root-type transducer outputs.
Rolling Average	This takes the average value of a single channel over a specified number of readings taken at a specified interval. The function value is retained during power off.
MKT	Mean Kinetic Temperature. A single calculation to simulate non-isothermal effects of variations in storage temperature.
10 to the power	Output = 10 raised to the power of the selected input value.
Group Latched Minimum	Outputs the minimum value reached by any of the points in a selected source group since last reset. The function ignores points that are not producing valid PV. A disable job stops the function reading its input. A reset job sets the function to the current minimum value within the group. Note that for proper operation, the maths function must be in a group which is not the source group. If this is not the case, it will always see itself as the lowest valued point in the group, and Reset operations will have no useful effect.
Group Latched Maximum	As for Group Latched Minimum, above, but outputs the maximum value of the source group.
Sample and Hold	This function is initiated by a trigger job. At trigger time, the selected point value is sampled, and its value at trigger time is output continuously by this function. On reset, the PV becomes 'No data'.
Square Root	Outputs the square root of the value of the selected point.
High Select	Allows two points to be selected as inputs. The output of the function is the value of that input point which currently has the higher value.
Low Select	Allows two points to be selected as inputs. The output of the function is the value of that input point which currently has the lower value.
Saturated Steam Mass Flow	Calculates mass flow in kg/s for saturated steam, using either the steam temperature (Celsius) or pressure (MPa) as appropriate to the process.
Saturated Steam Heat Flow	Calculates the energy flow in kJ/s for saturated steam, using either the steam temperature (Celsius) or pressure (MPa) as appropriate to the process.
Saturated Steam Heat Consumed	Calculates the heat consumed in kJ/s for saturated steam, using the inlet steam temperature (Celsius) or pressure (MPa) (as appropriate to the process), and the return (condensate) temperature.
Group MKT	Calculates Mean Kinetic Temperature of a specified group of channels

4.3.11 FUNCTION (Cont.)

Log Base 10	Takes \log_{10} of selected input. (For example: Input = 2 gives maths function value = 0.3010)
Log Base e	Takes \log_e of selected input. (For example: Input = 2 gives maths function value = 0.6931)
e to the power	Takes natural antilog of input. (For example: Input = 0.6931 gives maths function value = 2)
Modulus	This function copies the magnitude of the input value, without the sign. For example, the modulus of value +100 = +100; the modulus of -100 = +100.
Channel Maximum	Maths function value is the minimum value the input point has reached since last reset. When reset, the value is reset to the current input value.
Channel Minimum	Maths function value is the minimum value the input point has reached since last reset. When reset, the value is reset to the current input value.
Channel Average	Takes the average value of the selected channel over a specified time period. The time period must be a multiple of 125 msec. For example, a period of 0.2 seconds would be rejected, but a period of 0.25 seconds would be accepted.
Master comms	Allows a maths channel to read point values from other instruments on the Modbus link. If virtual channels are used - see section 4.3.22 .
Rate of change	Produces a value for the speed at which a signal changes over a specified period.
O ₂ Correction	This function carries out O ₂ correction of gas measurements for use in Continuous Emissions Monitoring applications.
Relative Humidity	This uses wet and dry bulb temperatures and atmospheric pressure inputs to produce a percentage Relative Humidity reading.
Zirconia probe	Allows oxygen concentration and oxygen potential to be determined by solving the Nernst oxygen equation.
Timestamp	When triggered by an event or alarm job, this causes the current number of milliseconds since 00:00 hrs on 1st January 1970 to appear as the function value. If the selected PV format is date or time, the result is displayed as date or time, respectively.
Config Revision Number*	Allows the Configuration Revision number to be used as the input to a maths channel. When this maths channel is included in a group, the user can determine the Configuration Revision number obtaining at any time in the history record.
Security Revision Number*	Allows the Security Revision number to be used as the input to a maths channel. When this maths channel is included in a group, the user can determine the Security Revision number obtaining at any time in the history record.

*Note: See 'About' in [section 4.6](#) for a description of the Configuration and Security Revision numbers.

Thermocouple Cal Correction

Defines correction points allowing offsets to be added to channel inputs to compensate (for example) for equipment errors.

SCALE LOW / SCALE HIGH

The 'zero' and full scale values for the maths function, as displayed. If A/B switching is enabled, a second set of scale low and scale high values can be entered. 'A' values are used during normal operation. 'B' values are switched to by job action, as described in [section 4.7](#).

4.3.11 FUNCTION (Cont.)

PV FORMAT

Numeric	Provides a decimal value for the maths channel.
Elapsed time	Shows the maths channel value in HH:MM:SS (hours minutes, seconds) format. Normally used only for time functions. For other functions, elapsed time counts in milliseconds e.g. a PV of 10000 would be displayed as 00:00:10; a PV of 60000 would be displayed as 00:01:00
Scientific	Values are displayed and entered as a decimal number between 1.0 and 10† (the mantissa), followed by a multiplier (the exponent). E.G. to enter a value of 1244.5678, the value entered would be 1.2445678E3, where 3 represents the number of places that the decimal point must be shifted to the left in order to convert the value to a number between 1 and 10†. To enter a value of 0.0004196, the entry would be 4.196E-4.
Time/date	For timestamp functions, displays the timestamp as time or date as selected, instead of a number of milliseconds, as would be displayed in numeric format.

† Notes

1. Strictly this is a number less than 10, as 10 would be 1.0E1.
2. There must be at least one number after the decimal point.

REMAINING CONFIGURATION ITEMS

The remaining configuration items are identical with the relevant items in Input Channel configuration (section 4.3.3).

FUNCTION DETAILS

POLYNOMIAL FIT

A polynomial curve fit of up to eight orders:

$A_0 + A_1(X) + A_2(X^2) + A_3(X^3) + A_4(X^4) + A_5(X^5) + A_6(X^6) + A_7(X^7) + A_8(X^8)$ where X is the value of the source channel and A0 to A8 are constants. Figure 4.11.3b shows the configuration items for a third order fit with channel 2 used as the source (X), and A0 = 1, A1 = 2, A2 = 3 and A3 = 4.

The image shows a configuration window for a polynomial fit. The fields are as follows:

- Maths Number: 1) Math 1
- Value: OFF
- Units: (empty)
- Function: Polynomial
- Orders: 3
- Polynomial of: Channel 2
- A0: 1
- A1: 2
- A2: 3
- A3: 4
- Units: (empty)

Figure 4.11.3b Polynomial configuration fields (3rd order)

4.3.11 FUNCTION (Cont.)

FVALUE

To calculate the equivalent time at Sterilizing Temperature (for temperatures below, at and above Sterilizing Temperature) both in dry (FH) and steam (FO) sterilizing environments, using the following equation:

$$Fval_t = Fval_{t-1} + T \times 10^{\frac{ma_t - \text{Target temp}}{Z}}$$

Where $Fval_t$ = F value at time t (minutes)

$Fval_{t-1}$ = F value last iteration

T = Internal recorder iteration interval (minutes)

ma_t = Value of temperature measuring channel

Target temp = 121.1°C for FO; 170°C for FH

Z = Temperature interval representing a factor-of-10 reduction in killing efficiency

= 10°C for FO; = 20°C for FH

User configuration consists of entering the channel which is measuring temperature, the relevant sterilizing temperature and temperature interval (Z-value) and a low cut-off value, if required.

Figure 4.3.11c shows the configuration fields for measuring Fo, using channel 1 as the temperature input channel, Fo values for target temperature (121.1°C) and z-value (10°C), and 75°C as the low cut-off value, below which killing credits are not to be counted.

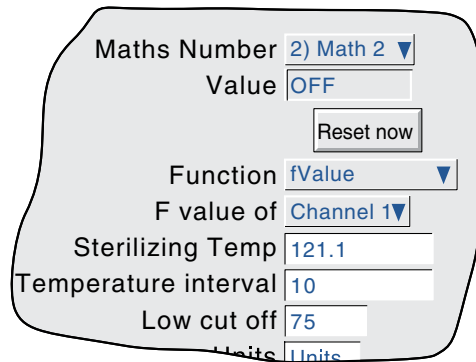

Figure 4.3.11c: Fo setup example

APPLICATION NOTE

To ensure that sterilizer loads which contain materials with differing thermal inertias are thoroughly sterilized, a typical sterilizer has up to 12 different measuring points within the load. To ensure accuracy, the temperature sensors should be calibrated, and the channel adjustment facility used to compensate for any inaccuracies found.

If each of the inputs is used to compute an F value, each of these values can then be used as an input to a Group Minimum function, with a high absolute alarm set at the correct F value. The alarm output can be used to sound a warning, or an associated relay can be linked into the autoclave control system to signify the end of a sterilization cycle.

4.3.11 FUNCTION (Cont.)

LINEAR MASS FLOW

Note: The overall accuracy of a flow measurement installation depends on a number of factors outside the control of the recorder manufacturer. For this reason, the recorder manufacturer takes no responsibility for the accuracy of the results obtained using the mass flow equations implemented in the maths pack.

The equations solved is:

$$QM_t = \frac{K}{Rg \times Z} \times \frac{\text{Flow}_t \times \text{AbsP}_t}{\text{Temp}}$$

where, QM_t = Mass flow (in kg/sec), at time 't'

K = Scaling factor (see below)

Rg = Specific gas constant in J/kg-K (see below)

Z = Compressibility factor (see below)

Flow_t = Measured value from the flow meter at time 't'

AbsP_t = Absolute pressure of the fluid at time 't' in kPa(A)

Temp = Temperature of the fluid in Kelvins

Scaling factor This is determined from an assumed value of Q_m at a known Flow, AbsP and Temp. The value is chosen to give an output within the range low scale to high scale.

Specific gas constant The specific gas constant for any gas is available from published tables. For convenience, the value for a number of common gases is given in table 4.3.11a, below.

Gas	RG (J/kg-K)
Air	287.1
Ammonia	488.2
Carbon dioxide	188.9
Carbon monoxide	296.8
Ethylene	296.4
Hydrogen	4116.0
Methane	518.4
Nitrogen	296.8
Oxygen	259.8
Propane	188.5
Steam	461.4

Table 4.3.11a Common gas constants

4.3.11 FUNCTION (Cont.)**LINEAR MASS FLOW (Cont.)**

Compressibility factor (Z-Factor)

Compressibility factor is a density-related measure of how far a particular gas deviates from a 'perfect' gas under any set of temperature and pressure conditions, and is given by the equation:

$$Z = \frac{P}{T} \times \frac{1}{\rho}$$

where: Z = Compressibility factor

P = Absolute pressure of the gas in kPa(A)

T = Absolute temperature of the gas (Kelvins)

ρ = gas density at pressure P and temperature T (from published tables)

CONFIGURABLE PARAMETERS

Figure 4.3.11d shows the relevant part of the configuration menu for a maths channel with 'Linear Mass Flow' function selected.

Maths Number 1) Math 1 ▾
 Value 123.4567 Units
 Function Linear Mass Flow ▾
 Flow Channel 1 ▾
 Temperature Channel 2 ▾
 Absolute Pressure Channel 3 ▾
 Scale o/p 0
 Ma 0
 Gas Constant 0 J/kg-K
 Z 0
 Units Units
 Apply Discard

Figure 4.3.11d Linear mass flow menu

Flow	Allows the input channel measuring the flowmeter output to be entered
Temperature	Allows the input channel measuring the fluid temperature (Kelvins) to be entered
Absolute Pressure	Allows the input channel measuring the absolute gas pressure (kPa(A)) to be entered
Scale o/p	Full scale output from the flowmeter in flowmeter units (S)
Ma	Full scale input range set for 'Flow' channel in flowmeter units (ma_{max})
Gas Constant	the relevant gas constant in J/kg-K
Z	The compressibility factor described above.

4.3.11 FUNCTION (Cont.)

ROOT MASS FLOW

Note: The overall accuracy of a flow measurement installation depends on a number of factors outside the control of the recorder manufacturer. For this reason, the recorder manufacturer takes no responsibility for the accuracy of the results obtained using the mass flow equations implemented in the maths pack.

The equation solved is:

$$QM_t = \sqrt{\frac{K^2}{Rg \times Z}} \times \sqrt{\frac{\text{Delta}P_t \times \text{Abs}P_t}{\text{Temp}}}$$

where QM_t = Mass flow (in kg/sec), at time 't'

K = Scaling factor (see below)

Rg = Specific gas constant in J/kg-K (see below)

Z = Compressibility factor (see below)

$\text{Delta}P_t$ = Measured value across the orifice plate at time 't'

$\text{Abs}P_t$ = Absolute pressure of the fluid at the up-stream tapping at time 't' in kPa(A)

Temp = Temperature of the fluid at the up-stream tapping in Kelvins

Scaling factor This is determined from an assumed value of Q_m at a known $\text{Delta}P$, $\text{Abs}P$ and Temp. The value is chosen to give an output within the range low scale to high scale.

Specific gas constant The specific gas constant for any gas is available from published tables. For convenience, the value for a number of common gases is given in [table 4.3.11a](#), above.

Compressibility factor (Z-Factor)

Compressibility factor is a density-related measure of how far a particular gas deviates from a 'perfect' gas under any set of temperature and pressure conditions, and is given by the equation:

$$Z = \frac{P}{T} \times \frac{1}{\rho}$$

where: Z = Compressibility factor

P = Absolute pressure of the gas in kPa(A)

T = Absolute temperature of the gas (Kelvins)

ρ = gas density at pressure P and temperature T (from published tables)

4.3.11 FUNCTION (Cont.)**ROOT MASS FLOW (Cont.)**

CONFIGURABLE PARAMETERS

Figure 4.3.11e shows the relevant part of the configuration menu for a maths channel with 'Root Mass Flow' function selected.

Figure 4.3.11e Root mass flow menu

Delta Pressure	Allows the input channel measuring the differential pressure output from the orifice plate to be entered
Temperature	Allows the input channel measuring the fluid temperature (Kelvins) at the upstream tapping to be entered
Absolute Pressure	Allows the input channel measuring the absolute gas pressure (kPa(A)) to be entered
Scale o/p	Full scale output from the flowmeter in flowmeter units (S)
Ma	Full scale input range set for 'Flow' channel in flowmeter units (mamax)
Gas Constant	The relevant gas constant in J/kg-K
Z	The compressibility factor described above.

4.3.11 FUNCTION (Cont.)

ROLLING AVERAGE

This calculates the average value of the last R samples of a channel, taken at N second intervals, where R and N can be defined by the user. At initiation, up to the time of the first sample reading, the displayed value is the average of the channel sampled every iteration (i.e. at 8 Hz).

The number of readings over which the average can be taken is limited by the amount of free RAM instantaneously available, and is thus dependent on the overall configuration of the recorder. An instrument alarm is generated if there is insufficient free RAM available - see [section 3.1.3](#) for details.

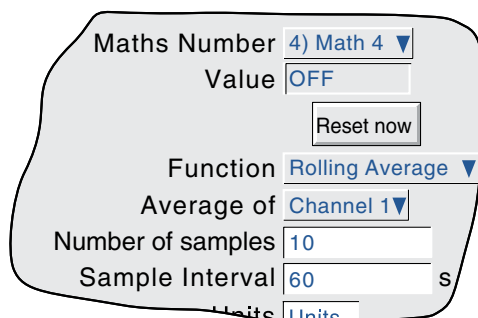

Figure 4.3.11f Rolling average menu

MEAN KINETIC TEMPERATURE (MKT)

MKT is defined as 'the isothermal temperature that corresponds to the kinetic effects of time-temperature distribution'. The recorder calculates MKT, using the equation below:

$$T_k = \frac{-\Delta H}{R \ln \left(\frac{e^{\frac{-\Delta H}{RT_{1max}}} + e^{\frac{-\Delta H}{RT_{1min}}} + \dots + e^{\frac{-\Delta H}{RT_{Nmax}}} + e^{\frac{-\Delta H}{RT_{Nmin}}}}{2N} \right)}$$

where: T_k = The required mean kinetic temperature in Kelvins

ΔH = The heat of activation

R = The universal gas constant

T_{1max} = The highest temperature reached during the first measurement period (in Kelvins)

T_{1min} = The lowest temperature reached during the first measurement period (in Kelvins)

T_{Nmax} = The highest temperature reached during the Nth measurement period (in Kelvins)

T_{Nmin} = The lowest temperature reached during the Nth measurement period (in Kelvins)

N = The total number of measurement periods

As described in 'Configurable items, below, this is simplified for the recorder user, to four entries viz: The number of the channel measuring temperature, the number of samples to be used, the time between the samples and the relevant 'Heat of Activation'.

Note: The input temperature must be in Kelvins. This can be achieved either by setting the relevant channel's units to Kelvins, or by using a further maths channel to convert the measuring units to Kelvins.

($K = ^\circ C + 273.15$ or $K = 0.555(^{\circ}F - 32) + 273.15$).

4.3.11 FUNCTION (Cont.)**MEAN KINETIC TEMPERATURE (Cont.)**

CONFIGURABLE ITEMS

Figure 4.3.11g shows the configurable items for the MKT function.

Figure 4.3.11g MKT function parameters

Mean Kinetic Temperature of

Select the source from which MKT is to be derived. This may be an input channel, scaled in Kelvins, or it can be a maths channel used to convert a different temperature scale into Kelvins (see 'Note' on previous page).

Number of Samples Enter the number of samples over which the MKT is to be measured.

Sample interval Enter the time period, in seconds, between samples. At each sample interval, the maximum and minimum temperatures reached by the input source, since the last sample, are entered into the equation.

Heat of Activation The default value is an average value based on many common organic reactions. Allows the user to enter an alternative value, if known.

EXAMPLE 1: To Produce a 4-weekly value of MKT, taking samples every day.

Number of samples = 28

Sample interval = No. of seconds in a day = $24 \times 60 \times 60 = 86,400$

EXAMPLE 2: To produce an annual value of MKT, taking samples every week.

Number of sample = 52

Sample interval = No. of seconds in a week = $7 \times 24 \times 60 \times 60 = 604,800$

Notes

- 1 This function produces a 'rolling' result. I.E. when the final (Nth) sample has been taken, the next sample (N + 1)th replaces Sample 1, the (N + 2th) sample replaces Sample 2, and so on.
 - 2 During the first sample, the current minimum and maximum values of temperature are entered into the equation at the recorder iteration rate (i.e. 8Hz).
 3. The number of readings over which the value can be taken is limited by the amount of free RAM instantaneously available, and is thus dependent on the overall configuration of the recorder. An instrument alarm is generated if there is insufficient free RAM available - see section 3.1.3 for details.
-

4.3.11 FUNCTION (Cont.)

SATURATED STEAM MASS FLOW

Note: The overall accuracy of a flow measurement installation depends on a number of factors outside the control of the recorder manufacturer. For this reason, the recorder manufacturer takes no responsibility for the accuracy of the results obtained using the mass flow equations implemented in the maths pack.

The equation solved is:

$$QM_t = \frac{\text{Flow}_t}{V_{LT} + \Delta V_T \left(\frac{d}{100}\right)}$$

where, QM_t = Mass flow (in kg/sec), at time 't' (Note 1)

Flow_t = Measured flow in m³/sec. at time 't' (Note 1)

V_{LT} = Volume of liquid per kg of steam (m³/kg) at temperature T °C

$\Delta V_T = V_{VT} - V_{LT}$, where V_{VT} is the volume of vapour per kg of steam at temperature T °C

d = Dryness factor between 0 (no vapour) and 100 (no liquid)

V_{LT} and ΔV_T are available from published tables (note 2), but the recorder user need only enter 'values' for measured flow and either the temperature or the pressure of the steam. These 'values' can be constants, input channels or maths channels. Figure 4.3.11h and accompanying parameter descriptions give full details.

The screenshot shows a configuration window for 'Saturated Steam Mass Flow'. It contains the following fields and values:

- Maths Number: 1) Math 1
- Value: 123.4567 Units
- Function: Saturated Steam Mass Flow
- Flow: Channel 1
- Use: Temperature
- Temperature: Channel 2
- Dryness: 0 %
- Units: Units

Buttons for 'Apply' and 'Discard' are located at the bottom of the configuration area.

Figure 4.3.11h Typical Saturated Steam Mass Flow configuration page

PARAMETERS

Flow	Select 'Constant' or the number of the channel supplying the measured flow rate. If 'Constant' selected, a further 'box' allows the value for the constant to be entered.
Use	Allows the user to select Temperature (°C) or Pressure (MPa) for the calculation.
Temperature	Appears only if Use = Temperature. Select 'Constant' or the number of the channel supplying the steam temperature. If 'Constant' is selected, a further 'box' allows a value for the constant to be entered.
Pressure	Appears only if Use = Pressure. Select 'Constant' or the number of the channel supplying the steam pressure. If 'Constant' is selected, a further 'box' allows a value for the constant to be entered. Table 4.3.11b, below, gives multipliers for converting some common pressure units to MPa. More details may be found at websites http://www.ex.ac.uk/trol/scol/ccpress.htm and http://www.onlineconversion.com/pressure.htm , amongst others.
Dryness	Enter a value between 0 and 100 to represent the dryness of the steam. 0 = no vapour; 100 = no liquid.

Notes:

- 1 The units of kg/sec and m³/sec are used above for simplicity. In fact any time unit can be used. For example if the measured flow is in m³/hour, then the Mass flow will be in kg/hour.
2. ASME Steam tables 1999, from IAPWF IF97.

4.3.11 FUNCTION (Cont.)

SATURATED STEAM MASS FLOW (Cont.)

PRESSURE UNITS CONVERSION

There is a wide range of pressure measuring units in use throughout the world. The following table gives a multiplication factor for converting some common units to MPa (MegaPascals), to four significant figures. Further conversion factors can be found at the websites given on the previous page. (Where the conversion is to Pascals, not to MegaPascals, the factors given have to be divided by 1,000,000.)

Pressure units	Multiplier for MPa	Pressure units	Multiplier for MPa
Atmospheres	0.1013	Newtons/cm ²	0.01
Bar	0.1	Newtons/m ²	0.000 001
kg/cm ²	0.09 807	Pascals	0.000 001
kNewton/m ²	0.001	Tonnes/m ²	0.009 807
kPa	0.001	Tons(UK)/ft ²	0.1 073
mBar	0.0001	Tons(US)/ft ²	0.09 576
Lb/ft ²	0.00 004 788	Water (feet of)	0.002 989
Lb/in ² (PSI)	0.006 895	Water (inches of)	0.0 002 491
Mercury (inches of)	0.003 386	Water (mm of)	0.000 009 807
Mercury (mm of)	0.0 001 333		

Table 4.3.11b Pressure unit conversion

The table above shows multiplying factors to convert common pressure units to MPa. This conversion is carried out as follows:

Example: A pressure transducer, connected to input channel 3 gives an output in the range 10 to 100 PSI. The input to a steam equation in maths channel 1 requires the pressure units to be MPa. To convert, set up a further maths channel (e.g. No. 2) as shown below, then use maths channel 2 as the source channel for the pressure input to the steam equation.

The suggested scale low/high values are based on the resulting pressure range in MPa - i.e 0.06895 to 0.6895.

The screenshot shows a configuration menu for a maths channel. The menu items and their values are as follows:

- Maths Number: 2) Steam Pressure
- Value: 0.0348
- Units: (blank)
- Function: Multiply
- Multiply: Channel 3
- by: Constant
- Constant Value: 0.006895
- Units: MPa
- Descriptor: Steam Pressure
- Scale low: 0 MPa
- Scale high: 1 MPa

At the bottom of the menu are two buttons: "Apply" and "Discard".

Figure 4.3.11i PSI to MPa conversion example

4.3.11 FUNCTION (Cont.)

SATURATED STEAM HEAT FLOW

Note: The overall accuracy of a flow measurement installation depends on a number of factors outside the control of the recorder manufacturer. For this reason, the recorder manufacturer takes no responsibility for the accuracy of the results obtained using the mass flow equations implemented in the maths pack.

The equation solved is:

$$QE_t = \left(\frac{\text{Flow}_t}{V_{LT} + \Delta V_T \left(\frac{d}{100} \right)} \right) \left(h_{LT} + \Delta h_T \left(\frac{d}{100} \right) \right)$$

where, QE_t = Heat energy flow (in kJ/sec), at time 't' (Note 1)

Flow_t = Measured flow in m³/sec (Note 1)

V_{LT} = Volume of liquid per kg of steam (m³/kg) at temperature T °C

$\Delta V_T = V_{VT} - V_{LT}$, where V_{VT} is the volume of vapour per kg of steam at temperature T °C

d = Dryness factor between 0 (no vapour) and 100 (no liquid)

h_{LT} = Enthalpy of the liquid in kJ/kg at temperature T °C

$\Delta h_T = h_{VT} - h_{LT}$, where h_{VT} is the enthalpy of vapour in kJ/kg vapour at temperature T °C

V_{LT} and ΔV_T ; h_{LT} and Δh_T are available from published tables (note 2), but the recorder user needs only to enter 'values' for measured flow and either the temperature or the pressure of the steam. These 'values' can be constants, input channels or maths channels. Figure 4.3.11j and accompanying parameter descriptions give full details.

Figure 4.3.11j Typical Saturated Steam Heat Flow configuration page

PARAMETERS

Flow	Select 'Constant' or the number of the channel supplying the measured flow rate. If 'Constant' selected, a further 'box' allows the value for the constant to be entered.
Use	Allows the user to select Temperature (°C) or Pressure (MPa) for the calculation.
Temperature	Appears only if Use = Temperature. Select 'Constant' or the number of the channel supplying the steam temperature. If 'Constant' is selected, a further 'box' allows a value for the constant to be entered.
Pressure (note 3)	Appears only if Use = Pressure. Select 'Constant' or the number of the channel supplying the steam pressure. If 'Constant' is selected, a further 'box' allows a value for the constant to be entered.
Dryness	Enter a value between 0 and 100 to represent the dryness of the steam. 0 = no vapour; 100 = no liquid.

Notes:

- 1 The units of kg/sec and m³/sec are used above for simplicity. In fact any time unit can be used. For example if the measured flow is in m³/hour, then the Mass flow will be in kg/hour.
2. ASME Steam tables 1999, from IAPWF IF97.
3. See 'Saturated Steam Mass Flow' above for details of pressure unit conversion

4.3.11 FUNCTION (Cont.)

SATURATED STEAM HEAT CONSUMED

Note: The following assumptions are made with regard to this implementation:

1. The condensate return is 100% wet saturated water. No flash steam component is included.
2. The same mass leaves the system as enters it.

Note: The overall accuracy of a flow measurement installation depends on a number of factors outside the control of the recorder manufacturer. For this reason, the recorder manufacturer takes no responsibility for the accuracy of the results obtained using the mass flow equations implemented in the maths pack.

The equation solved is:

$$QE_t = \left(\frac{\text{Flow}_t}{V_{LT1} + \Delta V_{T1} \left(\frac{d}{100} \right)} \right) \left(h_{LT1} + \Delta h_{T1} \left(\frac{d}{100} \right) - h_{LT2} \right)$$

where, QE_t = Heat energy consumed (in kJ/sec), at time 't' (Note 1)

Flow_t = Measured flow in m³/sec (Note 1)

V_{LT1} = Volume of liquid per kg of steam (m³/kg) at temperature T1 °C

$\Delta V_{T1} = V_{VT1} - V_{LT1}$, where V_{VT1} is the volume of vapour per kg of steam at temperature T1 °C

d = Dryness factor between 0 (no vapour) and 100 (no liquid)

h_{LT1} = Enthalpy of the liquid in kJ/kg at temperature T1 °C

$\Delta h_{T1} = h_{VT1} - h_{LT1}$, where h_{VT1} is the enthalpy of vapour in kJ/kg vapour at temperature T1 °C

h_{LT2} = Enthalpy of the condensate liquid in kJ/kg at temperature T2 °C

V_{LT1} and ΔV_{T1} ; h_{LT1} , h_{LT2} and Δh_{T1} are available from published tables (note 2), but the recorder user needs only to enter 'values' for measured flow, either the temperature or the pressure of the steam and the temperature of the condensate. These 'values' can be constants, input channels or maths channels. Figure 4.3.11l and accompanying parameter descriptions give full details.

Figure 4.3.11k is a simplified sketch of a typical installation, showing where flow rate, pressure and temperature readings are taken.

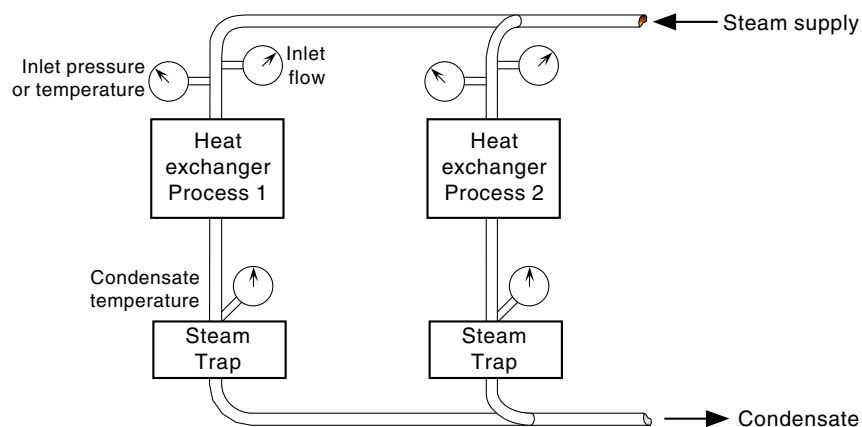

Figure 4.3.11k Measurement transducer - typical locations

Notes:

1. The units of kg/sec and m³/sec are used above for simplicity. In fact any time unit can be used. For example if the measured flow is in m³/hour, then the Mass flow will be in kg/hour.
2. ASME Steam tables 1999, from IAPWF IF97.

4.3.11 FUNCTION (Cont.)

SATURATED STEAM HEAT CONSUMED (Cont.)

Maths Number
 Value Units
 Function
 Inlet Flow
 Use
 Inlet Pressure
 Inlet Dryness %
 Return Temperature
 Units

Figure 4.3.11l Typical Saturated Steam Heat Flow configuration page

PARAMETERS

Inlet Flow	Select 'Constant' or the number of the channel supplying the measured flow rate. If 'Constant' selected, a further 'box' allows the value for the constant to be entered.
Use	Allows the user to select Temperature (°C) or Pressure (MPa) for the calculation.
Inlet Temperature	Appears only if Use = Temperature. Select 'Constant' or the number of the channel supplying the steam temperature. If 'Constant' is selected, a further 'box' allows a value for the constant to be entered.
Inlet Pressure	Appears only if Use = Pressure. Select 'Constant' or the number of the channel supplying the steam pressure. If 'Constant' is selected, a further 'box' allows a value for the constant to be entered.
Inlet Dryness	Enter a value between 0 and 100 to represent the dryness of the steam. 0 = no vapour; 100 = no liquid.
Return Temperature	Select 'Constant' or the number of the channel supplying the condensate temperature. If 'Constant' is selected, a further 'box' allows a value for the constant to be entered.

*Note: See Saturated Steam Mass Flow, above, for details of [pressure unit conversion](#)

GROUP MKT

Similar in operation to [MKT](#), described above, except that the MKT is derived from a specified group of points rather than a single point. For each sample period, the maximum and minimum values reached by any point(s) within the specified group are saved, and used as inputs to the Equation.

Maths Number
 Value Units
 Function
 Source
 Number of samples
 Sample interval s
 Heat of Activation kJ/mole
 Units

Figure 4.3.11m Group MKT configuration page

4.3.11 FUNCTION (Cont.)

RATE-OF-CHANGE

The equation solved is:

$$\frac{dPV}{dt} = \frac{In_t - In_{t-P}}{P} \times R$$

Where:

dPV/dt = Rate of change of PV with time

In_t = Input value 'this time'

In_{t-P} = Input value 'last time' (i.e. 'this time' - P)

P = Sample period (i.e. 'this time' - 'last time') in seconds. Only periods that are a multiple of 0.125 seconds are accepted.*

R = Scaling factor. Generally, R is the number of seconds in the required 'per unit time' value. For example: if R = 1, the rate is 'per second'; if R = 60, the rate is 'per minute'; if R = 3600, the rate is 'per hour'.

*Note: For channels being read over Modbus, the 'priority intervals' set in the Modbus Master configuration menu (section 4.3.16) may cause the readings to be inaccurate or to be continuously zero. For this reason, a minimum sample period of 1 second is recommended.

Maths Number 1) Math 1 ▼
 Value 0.0000 Units
 Reset now
 Function Rate of change ▼
 Rate of change of 1) Channel 1 ▼
 Sample period 0.125 s
 Rate Scalar 0.125
 Units Units
 Apply Discard

Figure 4.3.11n Rate of change configuration menu

4.3.11 FUNCTION (Cont.)**OXYGEN (O₂) CORRECTION**

This function carries out O₂ correction of gas measurements for use in Continuous Emissions Monitoring applications. The equation calculated is:

$$\text{Correction} = \frac{20.9\% - \text{Specified O}_2}{20.9\% - \text{Measured O}_2} \times \text{Measured Gas}$$

where,

Specified O₂ = specified oxygen entered as a constant 5-digit value (prescribed for the particular process).

Measured O₂ = measured oxygen, entered as a channel number (gas analyser input) (See application note, below).

Measured Gas = the measured gas, entered as a channel number (gas analyser input).

APPLICATION NOTE

Some Authorities allow Oxygen correction to be made ONLY if the Measured Oxygen value is above a limit specified by such Authorities.

For the oxygen correction function to conform with this requirement it is necessary to 'Filter' the Measured Oxygen value using a High Select function, with 'Measured Oxygen' and the Specified Limit constant as its inputs. The output from this function (derived channel number) is then used as the 'Measured oxygen' value.

Maths Number 1) Math 1 ▾
 Value 0.0000 Units
 Function O2 Correction ▾
 Measured O2 Channel 1 ▾
 Measured Gas Channel 2 ▾
 Specified O2 0 %
 Units Units
 Apply Discard

Figure 4.3.11p Oxygen correction configuration menu

4.3.11 FUNCTION (Cont.)

RELATIVE HUMIDITY

This determines the percentage relative humidity from wet and dry temperature and atmospheric pressure inputs.

Standard temperature and pressure at sea level are defined as 1.01325 Bar, and 15°C. Pressure varies with height as indicated in table 4.3.11c. The standard psychrometric constant is 0.000666 (6.66 x 10⁻⁴).

The equation solved is:

$$RH = \frac{A_0 + wA_1 + w^2A_2 + w^3A_3 + w^4A_4 + w^5A_5 - \{p \times AbsP(d - w)\}}{A_0 + dA_1 + d^2A_2 + d^3A_3 + d^4A_4 + d^5A_5}$$

Where:

RH = Percentage relative humidity

A₀ = 6.17204663 x 10⁻³

A₁ = 4.28096024 x 10⁻⁴

A₂ = 1.53342964 x 10⁻⁵

A₃ = 2.40833685 x 10⁻⁷

A₄ = 3.04249240 x 10⁻⁹

A₅ = 2.65867713 x 10⁻¹¹

p = Psychrometric constant (0.000666)

AbsP = Pressure in Bar (absolute not gauge)

d = Dry bulb temperature in degrees Celsius

w = Wet bulb temperature in degrees Celsius

Geometric height (metres)	Pressure (Bar)
-250	1.04365
0	1.01325
250	0.983576
500	0.954612
750	0.926346
1000	0.898762
1500	0.845596
2000	0.795014

Atmospheric pressure *versus* height

Table 4.3.11c

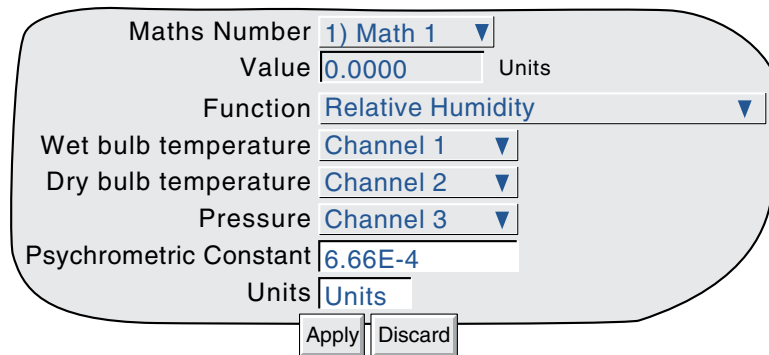

Figure 4.3.11q Relative humidity configuration menu

4.3.11 FUNCTION (Cont.)

ZIRCONIA PROBE

A zirconia (oxygen) probe consists of two platinum electrodes bonded to a pellet or cylinder of zirconia. At elevated temperatures, such a probe develops an emf across it which is proportional to probe temperature and to the log of the difference in oxygen partial pressure between its two ends.

OXYGEN CONCENTRATION

In order to measure oxygen concentrations, one end of the probe is inserted into the atmosphere to be measured, whilst the other is subjected to a reference atmosphere. For most applications, air provides a suitable reference (reference input = 20.95 for air).

The temperature of the probe is normally measured using a type K or type R thermocouple. The temperature effect on the thermocouple is such, that for successful operation, the probe temperature must be greater than 973K (700°C).

The equation solved by the maths function is:

$$P2 = \frac{P1}{10^{\frac{E}{0.0496 \times T}}}$$

where: P2 = Partial pressure of oxygen in the sampled gas (%)

P1 = partial pressure of oxygen in the reference atmosphere (%) (20.95% for air)

E = Electromotive force (emf) across the probe in mV

T = Probe temperature in Kelvins

Figure 4.3.11r shows the configuration menu. Figure 4.3.11s shows oxygen concentration versus probe emf for various temperatures.

Figure 4.3.11r Zirconia probe function configuration menu

To obtain a useful result, it is necessary to scale correctly.

The channel which is measuring the probe output would normally need to be set to: Input Type = mV; Input low = 0; input high = 100..

A typical temperature-measuring channel might be set up as:

Input Type = Thermocouple; Lin type = Type K; Range low = 273; Range high = 1800, Range units = K.

The maths channel scaling would typically be configured as:

Units = %; Scale Low = 0; Scale High = 5 (for boiler flues) or 10 (for kilns).

4.3.11 FUNCTION (Cont.)

ZIRCONIA PROBE (Cont.)

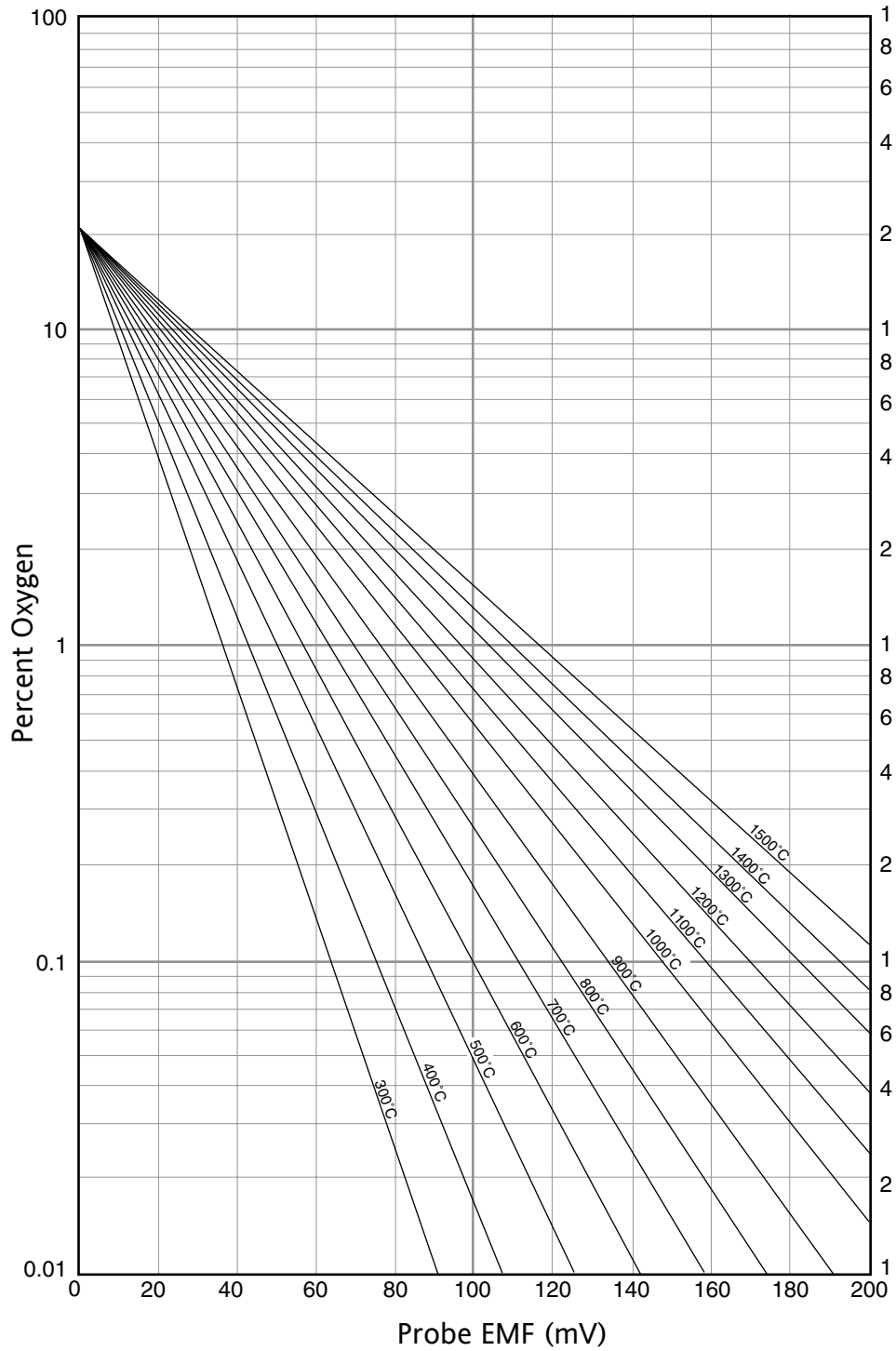

Figure 4.3.11s Probe emf versus temperature

4.3.11 FUNCTION (Cont.)

ZIRCONIA PROBE (Cont.)

OXYGEN POTENTIAL

The oxygen potential of an atmosphere is a measurement of its ability to oxidise or reduce. For any element, a value of oxygen potential (free energy of formation) is known. Above this value, the material will oxidise, below it, no oxidation will occur. Figure 4.3.11t, below, is a free energy diagram for a number of oxidising processes.

Oxygen potential is given by the equation

$$Op = 0.00457 \times T \times \log Op'$$

Where: Op = Required oxygen potential (in kilocalories)

T = Probe temperature (in Kelvins)

Op' = Partial pressure of oxygen in the reference atmosphere (in atmospheres)

It can be shown that, because the oxygen potential of air is essentially constant over the range 870 to 1450 kelvins, the zirconia probe output is proportional to the oxygen potential of an atmosphere, according to:

$$E = (10.84 \times T) + 40 \text{ mV (in the range 870 to 1450 K)}$$

Thus, it is possible to measure oxygen potential directly from a zirconia probe, using a standard input channel of the instrument, scaled in units of oxygen potential. A typical configuration might be:

Input Type = mV;

Input low = 40;

Input high = 1124;

Scale low = -100;

Scale high = 0;

Units = kCal.

Such a configuration would be suitable over the temperature range 873 to 1473 K (600 to 1200 °C).

4.3.11 FUNCTION (Cont.)

ZIRCONIA PROBE (Cont.)

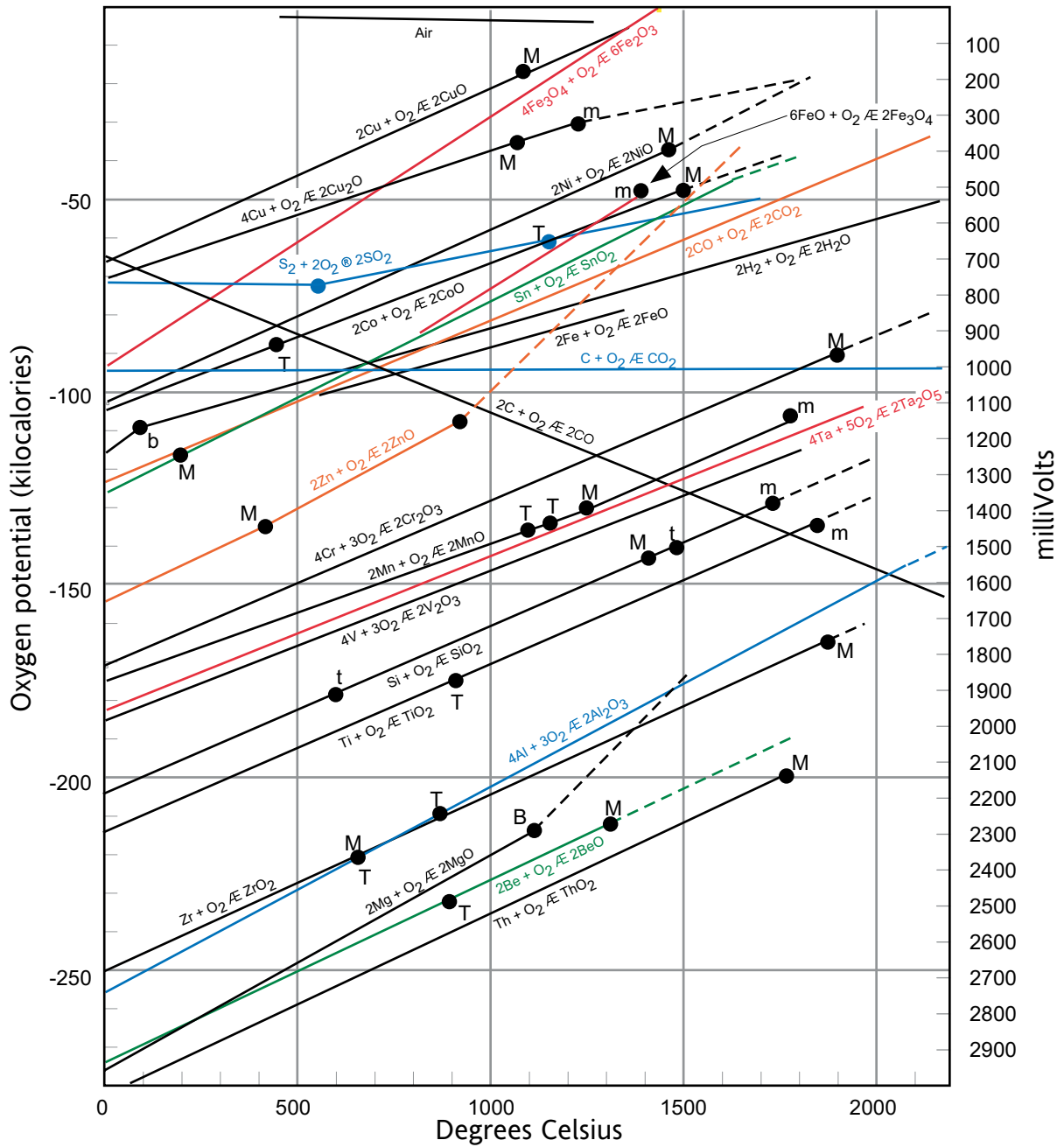

Note:
Colours serve no purpose in the figure above, other than to simplify interpretation.

Change of state	Element	Oxide
Melting point	M	m
Boiling point	B	b
Sublimation point	S	s
Transition point	T	t

Figure 4.3.11t Free energy diagram

4.3.11 FUNCTION (Cont.)

GROUP MINIMUM

The following description assumes a group name of 'Furnace 1', which contains four channels with descriptors 'Temp 1', 'Temp 2', 'Temp 3' and 'Temp 4'

The output of the Group Minimum function is the current lowest value of any of the points in the source group. The required source group is selected by picklist.

Should a point return a non-valid value, it is excluded from the calculation, and the result of the function is the minimum of the remaining points.

DESCRIPTORS

As a part of the Group Minimum function configuration, it is possible to select one of two types of descriptor: 'User Defined' and 'Minimum Channel'. Figure 4.3.11u, below shows the relevant area of the configuration page.

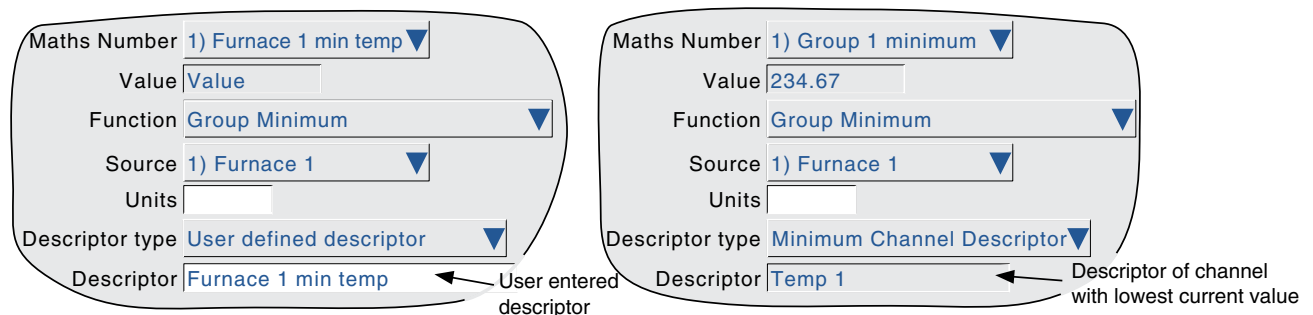

Figure 4.3.11u Group minimum configuration page

User Defined Descriptor.

This allows a descriptor to be entered in the normal way. For example 'Furnace 1 min temp'. This descriptor is copied to the Maths Number field at the top of the display page.

Minimum Channel Descriptor

This selection causes the descriptor of the point with the instantaneous current lowest value in the group, to become the (non-editable) maths channel descriptor. For example if the four channels in the group (Temp 1 to Temp 4) have the instantaneous values 800, 950, 790 and 873 respectively, then the Descriptor will be 'Temp 3'. Should Temp 3 rise above 800, whilst all the others remain static, then the Descriptor would become 'Temp 1'.

The 'Maths Number' field which normally copies the maths channel descriptor, contains instead the text: 'N) Group N minimum', where 'Group N' is the default name of the source group.

A typical application of the 'Minimum channel descriptor' would be to include the descriptor in a message sent to the chart on a regular basis by a Timer function.

[Section 4.3.8](#) describes the entry of the messages, and [section 4.3.14](#) describes the setting up of timers.

(Continued)

4.3.11 FUNCTION (Cont.)

GROUP MINIMUM (Cont.)

A typical message entry would be:

Message: Lowest temperature is {1} at chan {2}

Replace {1} with: Specified Value

{1} source: Group 1 minimum

Replace {2} with: Specified Descriptor

{2} source: Group 1 Minimum

resulting in a message such as:

22/08/08 14:22:06 Lowest temperature is 790.00 Units at chan Temp 3.

where 'Units' is the text entered in the Group Minimum maths channel configuration, not that for the input channel, although typically, they would be the same.

Note: The Group configuration checkboxes for maths channels with 'Minimum Channel Descriptor' selected, are 'greyed' thus preventing such channels from being used as inputs to their own source group. See [section 4.3.2](#) for Group configuration details.

4.3.11 FUNCTION (Cont.)**THERMOCOUPLE CAL CORRECTION**

This function allows two correction value tables, each of up to 25 points to be entered. For each point, a correction value can be entered, and the recorder will interpolate between points. The output of this maths function is the sum of the source channel and the two correction values. The Instrument correction values are obtained from a recorder calibration carried out by the user or by an agency; the thermocouple correction values are obtained from the thermocouple test certificate.

Figure 4.3.11v shows a configuration page with an 'Inst Calibration' table of three points, and a 'T/C calibration' table of four points.

The screenshot shows a configuration page for 'Thermocouple Cal Correction'. The settings are as follows:

- Maths Number: 1) Math 1
- Value: 100.00
- Units: (empty)
- Function: Thermocouple Cal Correction
- Thermocouple: 1) Channel 1
- Serial number: AX 10023
- Inst calibration points: 3
- Inst cal temp 1: 20
- Inst cal corr 1: -0.2
- Inst cal temp 2: 200
- Inst cal corr 2: 0.2
- Inst cal temp 3: 400
- Inst cal corr 3: -0.18
- T/C calibration points: 4
- T/C cal temp 1: 0
- T/C cal corr 1: -1.2
- T/C cal temp 2: 100
- T/C cal corr 2: -1.1
- T/C cal temp 3: 200
- T/C cal corr 3: -0.98
- T/C cal temp 4: 300
- T/C cal corr 4: -0.8
- Units: Units
- Descriptor: Math 1

Buttons for 'Apply' and 'Discard' are visible at the bottom.

Figure 4.3.11v Thermocouple Cal correction configuration page

Thermocouple	Select any real or virtual channel, or 'Constant' as the source channel.
Serial number	Enter an identifier for the thermocouple.
Inst calibration points	Enter the number of Instrument calibration points that are to be used (25 max.).
Inst cal temp n	The nth calibration point where 'n' = 1 to the 'Inst calibration points' value.
Inst cal corr n	The correction value for the nth calibration point.
T/C calibration points	Enter the number of Thermocouple calibration points that are to be used (25 max.).
T/C cal temp n	The nth calibration point where 'n' = 1 to the 'T/C calibration points' value.
T/C cal corr n	The correction value for the nth calibration point.

Other parameters are as described in 'Channel configuration' ([section 4.3.3](#))

Notes:

1. For both tables, each 'cal temp' value must be higher than the previous one.
2. For both tables, no correction is applied if the input is less than the minimum table entry, or greater than the maximum table entry.

4.3.11 MATHS OPTION (Cont.)

MODBUS ADDRESSING

For units fitted with the Modbus TCP comms option, the following table gives hex addresses for maths channel 1. Generally: Maths channel N parameter address = maths channel 1 parameter address + 162 (N-1) (decimal). For full details of the Modbus TCP implementation, see [section 8](#).

A/B switching
B values are not accessible via Modbus. Span, Zone, Colour etc. are all setting A

MATHS CHANNEL CONFIGURATION DATA

CHANNEL 1

Parameter Name	Description	Type	Access	Start Addr. Hex (Dec)	Register Length
Ch1 Span high	Upper span value (display full scale)	Scaled	Read only	2FF1 (12273)	1
Ch1 Span low	Lower span value (display 'zero')	Scaled	Read only	2FF2 (12274)	1
Ch1 Zone high	Zone high value (two decimal places)	Scaled	Read only	2FF3 (12275)	1
Ch1 Zone low	Zone low value (two decimal places)	Scaled	Read only	2FF4 (12276)	1
Ch1 PV type	Input type 1 = Analogue input 3 = Totaliser 2 = Maths 4 = Counter	Enum	Read only	2FF5 (12277)	1
Ch1 Decimal places	Number of decimal places (0 to 9) (used by all scaled parameters except where stated)	Uint16	Read only	2FF6 (12278)	1
Ch1 Colour	Channel colour (0 to 55) (See Annex B for RGB definitions)	Enum	Read only	2FF7 (12279)	1
Ch1 Units	Units string (up to five characters)	String_5	Read only	2FF8 (12280)	3
Spare				2FFB (12283)	2
Ch1 Open string	Open Digital Input string (up to eight characters)	String_8	Read only	2FFD (12285)	4
Spare				3001 (12289)	4
Ch1 Close string	Closed Digital Input string (up to eight characters)	String_8	Read only	3005 (12293)	4
Spare				3009 (12297)	4
Ch1 Descriptor	Channel descriptor (up to 20 characters)	String_20	Read only	300D (12301)	10
Spare				3017 (12311)	10
Ch1 No of alarms	Number of alarms on this channel	Uint16	Read only	3021 (12321)	1
Ch1 PV format	0 = Numeric 1 = Digital strings	Enum	Read only	3022 (12322)	1
Spare				3023 (12323)	60
Ch1 Alarm 1 enable	Alarm 1 enable 0 = Off 2 = Latched 1 = Unlatched 3 = Trigger	Enum	Read only	305F (12383)	1
Ch1 Alarm 1 type	Alarm 1 type 0 = Absolute low 1 = Absolute high 2 = Deviation in 3 = Deviation out 4 = Rate of change rise 5 = Rate of change fall	Enum	Read only	3060 (12384)	1
Ch1 Alarm 1 setpoint	Trigger setpoint (see note)	Scaled	Read/Write	3061 (12385)	1
Spare				3062 (12386)	10
Ch1 Alarm 2 enable	Alarm 2 enable (As alarm 1 enable above)	Enum	Read only	306C (12396)	1
Ch1 Alarm 2 type	Alarm 2 type (As alarm 1 type above)	Enum	Read only	306D (12397)	1
Ch1 Alarm 2 setpoint	Trigger setpoint (see note)	Scaled	Read/Write	306E (12398)	1
Spare				306F (12399)	10
Ch1 Alarm 3 enable	Alarm 3 enable (As alarm 1 enable above)	Enum	Read only	3079 (12409)	1
Ch1 Alarm 3 type	Alarm 3 type (As alarm 1 type above)	Enum	Read only	307A (12410)	1
Ch1 Alarm 3 setpoint	Trigger setpoint (see note)	Scaled	Read/Write	307B (12411)	1
Spare				307C (12412)	10
Ch1 Alarm 4 enable	Alarm 4 enable (As alarm 1 enable above)	Enum	Read only	3086 (12422)	1
Ch1 Alarm 4 type	Alarm 4 type (As alarm 1 type above)	Enum	Read only	3087 (12423)	1
Ch1 Alarm 4 setpoint	Trigger setpoint (see note)	Scaled	Read/Write	3088 (12424)	1
Spare				3089 (12425)	10

Note: If the setpoint source for an alarm ([section 4.3.3](#)) is set to anything other than 'Constant', the value returned is the previously configured constant value.

4.3.11 MATHS OPTION (Cont.)**MATHS CHANNEL RUN-TIME DATA**

This table show addresses for maths channel 1 run-time data. Generally: channel N address = channel 1 address + 3(N-1) (decimal)

CHANNEL 1

Parameter Name	Description	Type	Access	Start Addr. Hex (Dec)	Register Length
Ch1 value	Current process value (PV) Scaled	Read/Write	A2BA (41658)	1	
Ch1 status	Channel status 0 = Good PV 1 = Channel off 2 = Over range 3 = Under range 4 = Hardware error 5 = Ranging error 6 = Overflow 7 = Bad PV 8 = No data	Enum	Read only	A2BB (41659)	1
Ch1 Alarms	Alarm information Bit 0:0 = Alarm 1 inactive; 1 = Alarm 1 active Bit 1: 0 = No alarm 1 Ack. required; 1 = Ack. required Bit 2: 1 = Acknowledge alarm 1 Bit 3: Spare Bit 4: 0 = Alarm 2 inactive; 1 = Alarm 2 active Bit 5: 0 = No Alarm 2 Ack. required; 1 = Ack. required Bit 6: 1 = Acknowledge alarm 2 Bit 7: Spare Bit 8: 0 = Alarm 3 inactive; 1 = Alarm 3 active Bit 9: 0 = No alarm 3 Ack. required; 1 = Ack. required Bit 10: 1 = Acknowledge alarm 3 Bit 11: Spare Bit 12: 0 = Alarm 4 inactive; 1 = Alarm 4 active Bit 13: 0 = No Alarm 4 Ack. required; 1 = Ack. required Bit 14: 1 = Acknowledge alarm 4 Bit 15: Spare	Uint16	- Read only Read only Read/Write Read only Read only Read/Write Read only Read only Read/Write Read only Read only Read/Write	A2BC (41660)	1

IEEE 32-BIT CHANNEL CONFIGURATION DATA

The following table shows addresses for the specified 32-bit floating-point values, for Maths channel 1. Generally, Parameter address for channel N = Parameter address for channel 1 + 36(N-1) (decimal).

CHANNEL 1

Parameter Name	Description	Type	Access	Start Addr. Hex (Dec)	Register Length
Ch1 span high	Upper span value (Display full scale)	Float	Read only	DF73 (57203)	2
Ch1 span low	Lower span value (display 'zero')	Float	Read only	DF75 (57205)	2
Ch1 Zone high	Zone upper value (% of 'chart' width)	Float	Read only	DF77 (57207)	2
Ch1 Zone low	Zone lower value (% of 'chart' width)	Float	Read only	DF79 (57209)	2
Ch1 Alarm 1 setpoint	Trigger setpoint for alarm 1 (see note)	Float	Read/Write	DF7B (57211)	2
Ch1 Alarm 2 setpoint	Trigger setpoint for alarm 2 (see note)	Float	Read/Write	DF7D (57213)	2
Ch 1 Alarm 3 setpoint	Trigger setpoint for alarm 3 (see note)	Float	Read/Write	DF7F (57215)	2
Ch 1 Alarm 4 setpoint	Trigger setpoint for alarm 4 (see note)	Float	Read/Write	DF81 (57217)	2
Spare				DF83 (57219)	20

Note: If the setpoint source for an alarm (section 4.3.3) is set to anything other than 'Constant', the value returned is the previously configured constant value.

4.3.11 MATHS OPTION (Cont.)

IEEE 32-BIT CHANNEL RUN-TIME DATA

The following table gives addresses for the specified 32-bit floating-point values, for maths channel 1. Generally, Parameter address for channel N = Parameter address for channel 1 + 4(N-1) (decimal).

CHANNEL 1

Parameter Name	Description	Type	Access	Start Addr. Hex (Dec)	Register Length
Channel 1 value	Current process value (PV)	Float	Read/Write	F9EF (63983)	2
Channel 1 status	Channel status 0 = Good PV 5 = Ranging error 1 = Channel off 6 = Overflow 2 = Over range 7 = Bad PV 3 = Under range 8 = No data 4 = Hardware error	Enum	Read only	F9F1 (63985)	1
Channel 1 Alarms	Alarm information Bit 0: 0 = Alarm 1 inactive; 1 = Alarm 1 active Bit 1: 0 = No alarm 1 Ack. required; 1 = Ack. required Bit 2: 1 = Acknowledge alarm 1 Bit 3: Spare Bit 4: 0 = Alarm 2 inactive; 1 = Alarm 2 active Bit 5: 0 = No Alarm 2 Ack. required; 1 = Ack. required Bit 6: 1 = Acknowledge alarm 2 Bit 7: Spare Bit 8: 0 = Alarm 3 inactive; 1 = Alarm 3 active Bit 9: 0 = No alarm 3 Ack. required; 1 = Ack. required Bit 10: 1 = Acknowledge alarm 3 Bit 11: Spare Bit 12: 0 = Alarm 4 inactive; 1 = Alarm 4 active Bit 13: 0 = No Alarm 4 Ack. required; 1 = Ack. required Bit 14: 1 = Acknowledge alarm 4 Bit 15: Spare	Uint16	- Read only Read only Read/Write Read only Read only Read/Write Read only Read only Read/Write Read only Read only Read/Write	F9F2 (63986)	1

4.3.12 Totalisers

INTRODUCTION

Each totaliser allows the user to maintain a running total of any input channel, or of any maths channel. Using the maths functions, it is possible to totalise combinations of input channels, so the value of two channels added together, or the difference between two channels could be totalised if required. The totaliser equation is :

$$\text{tot}_t = \text{tot}_{t-1} + \frac{\text{ma}_t}{\text{PSF} \times \text{USF}}$$

where tot_t = totaliser value this sample*

tot_{t-1} = totaliser value last sample*

ma_t = value of totalised channel this sample*

PSF = Period Scaling Factor (See Period scaler description below)

USF = Units Scaling Factor (See Unit scaler description below)

*Note: Time between samples = Recording interval set in Group configuration.

See 'Update information' in Annex A for details.

CONFIGURATION

Figure 4.3,12, below, shows a typical (enabled) totaliser configuration page

Totaliser Number	Allows any of the available totalisers to be selected from the picklist, for configuration.
Enable	Allows the user to enable/disable the totaliser.
Value	Shows the (dynamic) current value of the selected totaliser.
Total of	Allows an input channel or a maths channel to be selected as the source to be totalised.
Low Cutoff	The value of the source channel (in engineering units) below which it is not to be totalised.
High Cutoff	The value of the source channel (in engineering units) above which it is not to be totalised.
Units	The totalised units (e.g. m ³)
Preset	Allows the entry of a 10-character positive, or nine-character negative value from which the totaliser is to start counting. Direction of counting is defined by the sign of the Unit scaler viz: + = increment; - = decrement.
Preset now	Operation of this key initiates the totaliser preset.

4.3.12 TOTALISER CONFIGURATION (Cont.)

The screenshot shows a configuration menu for a totaliser. The settings are as follows:

- Totaliser Number: 1) Totaliser 1 (dropdown) → Select totaliser number
- Enable:
- Value: 123456 Units (totaliser)
- Total of: Channel 1 (dropdown) → Select channel etc. to be totalised
- Low cut off: 0 ch units
- High cut off: 999999 ch units } Units of channel being totalised
- Units: Units
- Preset: 0 Units (totaliser)
- Preset now: [Button]
- Period scaler: 1
- Unit scaler: 1
- Descriptor: Totaliser 1
- A/B Switching: []
- Scale Low: 0 Units (totaliser)
- Scale High: 1 Units (totaliser)
- Zone Low: 1 %
- Zone High: 100 %
- Scale Type: None (dropdown) → Select None, Linear or Log
- PV format: Numeric (dropdown) → Select Numeric or Scientific
- Max Decimal Digits: 4
- Colour: 0
- Alarm Number: 1 (dropdown) → Select Alarm number
- Enable: Off (dropdown) → Select: Off, Unlatched, Latched, Trigger
- Job Number: 1 (dropdown) → Select Job number
- Category: No Action (dropdown) → Select Job category
- Apply: [Button]
- Discard: [Button]

Figure 4.3.12 Totaliser configuration menu

- Period Scaler** The totaliser equation works in seconds. If the totalised channel units are other than 'per second' a period scaler other than the default (1) must be entered. For example, if the input channel is in litres per hour, then the period scaler would have to be the number of seconds in an hour (3600).
- Unit Scaler** If, for example, the input channel is in litres per hour, the totalised value will be in litres, unless the unit scaler is set to a value other than 1. If it is more convenient, the totalised value can be in thousands of litres by setting the unit scaler to 1000. Setting the unit scaler negative causes the totaliser to decrement rather than increment.
- Scale Low/High** The 'zero' and full scale values for the totaliser, as traced on the screen. If A/B switching is enabled, a second set of scale low and scale high values can be entered. 'A' values are used during normal operation. 'B' values are switched to by job action, as described in [section 4.7](#).

The remaining configuration items are identical with the relevant items in Input Channel configuration ([section 4.3.3](#)), except that Log/Linear scale type is not available. For job information, see [section 4.7](#).

Note: Selecting 'High' compression in [Archive configuration](#) may cause very high totaliser values to be displayed incorrectly by the recorder and held incorrectly in the history file. This problem may be solved by moving the relevant point to a group using 'Normal' compression, or by re-scaling the totaliser to read (for example) TeraWatt hours instead of Megawatt hours.

4.3.12 (Cont.) TOTALISER MODBUS ADDRESSING

For units fitted with the Modbus TCP comms option, the following table gives addresses for totaliser 1 configuration data

Generally: Totaliser N parameter address = totaliser 1 parameter address + 162 (N-1) (decimal).

For full details of the Modbus TCP implementation, see [section 8](#).

TOTALISER CONFIGURATION DATA**TOTALISER 1**

Parameter Name	Description	Type	Access	Start Addr. Hex (Dec)	Register Length
Span high	Upper span value (display full scale)	Scaled	Read only	6F39 (28473)	1
Span low	Lower span value (display 'zero')	Scaled	Read only	6F3A (28474)	1
Zone high	Zone high value (two decimal places)	Scaled	Read only	6F3B (28475)	1
Zone low	Zone low value (two decimal places)	Scaled	Read only	6F3C (28476)	1
PV type	Input type 1 = Analogue input 3 = Totaliser 2 = Maths 4 = Counter	Enum	Read only	6F3D (28477)	1
Decimal places	Number of decimal places (0 to 9) (used by all scaled parameters except where stated)	Uint16	Read only	6F3E (28478)	1
Colour	Channel colour (0 to 55) (See Annex B for RGB definitions)	Enum	Read only	6F3F (28479)	1
Units	Units string (up to five characters)	String_5	Read only	6F40 (28480)	3
Spare				6F43 (28483)	2
Open string	Open Digital Input string (up to eight characters)	String_8	Read only	6F45 (28485)	4
Spare				6F49 (28489)	4
Close string	Closed Digital Input string (up to eight characters)	String_8	Read only	6F4D (28493)	4
Spare				6F51 (28497)	4
Descriptor	Channel descriptor (up to 20 characters)	String_20	Read only	6F55 (28501)	10
Spare				6F5F (28511)	10
No of alarms	Number of alarms on this channel	Uint16	Read only	6F69 (28521)	1
PV format	0 = Numeric 1 = Digital strings	Enum	Read only	6F6A (28522)	1
Spare				6F6B (28523)	60
Alarm 1 enable	Alarm 1 enable 0 = Off 2 = Latched 1 = Unlatched 3 = Trigger	Enum	Read only	6FA7 (28583)	1
Alarm 1 type	Alarm 1 type 0 = Absolute low 1 = Absolute high 2 = Deviation in 3 = Deviation out 4 = Rate of change rise 5 = Rate of change fall	Enum	Read only	6FA8 (28584)	1
Alarm 1 setpoint	Trigger setpoint (see note)	Scaled	Read/Write	6FA9 (28585)	1
Spare				6FAA (28586)	10
Alarm 2 enable	Alarm 2 enable (As alarm 1 enable above)	Enum	Read only	6FB4 (28596)	1
Alarm 2 type	Alarm 2 type (As alarm 1 type above)	Enum	Read only	6FB5 (28597)	1
Alarm 2 setpoint	Trigger setpoint (see note)	Scaled	Read/Write	6FB6 (28598)	1
Spare				6FB7 (28599)	10
Alarm 3 enable	Alarm 3 enable (As alarm 1 enable above)	Enum	Read only	6FC1 (28609)	1
Alarm 3 type	Alarm 3 type (As alarm 1 type above)	Enum	Read only	6FC2 (28610)	1
Alarm 3 setpoint	Trigger setpoint (see note)	Scaled	Read/Write	6FC3 (28611)	1
Spare				6FC4 (28612)	10
Alarm 4 enable	Alarm 4 enable (As alarm 1 enable above)	Enum	Read only	6FCE (28622)	1
Alarm 4 type	Alarm 4 type (As alarm 1 type above)	Enum	Read only	6FCF (28623)	1
Alarm 4 setpoint	Trigger setpoint (see note)	Scaled	Read/Write	6FD0 (28624)	1
Spare				6FD1 (28625)	10

Note: If the setpoint source for an alarm ([section 4.3.3](#)) is set to anything other than 'Constant', the value returned is the previously configured constant value.

4.3.12 (Cont.) TOTALISER MODBUS ADDRESSING

RUN-TIME DATA

This table shows addresses for totaliser 1. Generally: totaliser N address = totaliser 1 address + 3(N-1) (decimal)

TOTALISER 1

Parameter Name	Description	Type	Access	Start Addr. Hex (Dec)	Register Length
Value Status	Current process value (PV)	Scaled	Read/Write	A3E6 (41958)	1
	Channel status 0 = Good PV 5 = Ranging error 1 = Channel off 6 = Overflow 2 = Over range 7 = Bad PV 3 = Under range 8 = No data 4 = Hardware error	Enum	Read only	A3E7 (41959)	1
Alarms	Alarm information	Uint16	-	A3E8 (41960)	1
	Bit 0: 0 = Alarm 1 inactive; 1 = Alarm 1 active		Read only		
	Bit 1: 0 = No alarm 1 Ack. required; 1 = Ack. required		Read only		
	Bit 2: 1 = Acknowledge alarm 1		Read/Write		
	Bit 3: Spare				
	Bit 4: 0 = Alarm 2 inactive; 1 = Alarm 2 active		Read only		
	Bit 5: 0 = No Alarm 2 Ack. required; 1 = Ack. required		Read only		
	Bit 6: 1 = Acknowledge alarm 2		Read/Write		
	Bit 7: Spare				
	Bit 8: 0 = Alarm 3 inactive; 1 = Alarm 3 active		Read only		
	Bit 9: 0 = No alarm 3 Ack. required; 1 = Ack. required		Read only		
	Bit 10: 1 = Acknowledge alarm 3		Read/Write		
	Bit 11: Spare				
	Bit 12: 0 = Alarm 4 inactive; 1 = Alarm 4 active		Read only		
	Bit 13: 0 = No Alarm 4 Ack. required; 1 = Ack. required		Read only		
	Bit 14: 1 = Acknowledge alarm 4		Read/Write		
Bit 15: Spare					

IEEE 32-BIT CONFIGURATION DATA

The following table gives addresses for the specified 32-bit floating-point values, for Totaliser 1. Generally, Parameter address for totaliser N = Parameter address for totaliser 1 + 36(N-1) (decimal).

TOTALISER 1

Parameter Name	Description	Type	Access	Start Addr. Hex (Dec)	Register Length
Span high	Upper span value (Display full scale)	Float	Read only	ED83 (60803)	2
Span low	Lower span value (display 'zero')	Float	Read only	ED85 (60805)	2
Zone high	Zone upper value (% of 'chart' width)	Float	Read only	ED87 (60807)	2
Zone low	Zone lower value (% of 'chart' width)	Float	Read only	ED89 (60809)	2
Alarm 1 setpoint	Trigger setpoint for alarm 1 (see note)	Float	Read/Write	ED8B (60811)	2
Alarm 2 setpoint	Trigger setpoint for alarm 2 (see note)	Float	Read/Write	ED8D (60813)	2
Alarm 3 setpoint	Trigger setpoint for alarm 3 (see note)	Float	Read/Write	ED8F (60815)	2
Alarm 4 setpoint	Trigger setpoint for alarm 4 (see note)	Float	Read/Write	ED91 (60817)	2
Spare				ED93 (60819)	20

Note: If the setpoint source for an alarm (section 4.3.3) is set to anything other than 'Constant', the value returned is the previously configured constant value.

4.3.12 (Cont.) TOTALISER MODBUS ADDRESSING

IEEE AREA TOTALISER RUN-TIME DATA

The following table gives addresses for the specified 32-bit floating-point values, for totaliser 1. Generally, Parameter address for totaliser N = Parameter address for totaliser 1 + 4(N-1) (decimal).

TOTALISER 1

Parameter Name	Description	Type	Access	Start Addr. Hex (Dec)	Register Length
Totaliser 1 value	Current process value (PV)	Float	Read/Write	FB7F (64383)	2
Totaliser 1 status	Channel status 0 = Good PV 5 = Ranging error 1 = Channel off 6 = Overflow 2 = Over range 7 = Bad PV 3 = Under range 8 = No data 4 = Hardware error	Enum	Read only	FB81 (64385)	1
Totaliser 1 Alarms	Alarm information Bit 0: 0 = Alarm 1 inactive; 1 = Alarm 1 active Bit 1: 0 = No alarm 1 Ack. required; 1 = Ack. required Bit 2: 1 = Acknowledge alarm 1 Bit 3: Spare Bit 4: 0 = Alarm 2 inactive; 1 = Alarm 2 active Bit 5: 0 = No Alarm 2 Ack. required; 1 = Ack. required Bit 6: 1 = Acknowledge alarm 2 Bit 7: Spare Bit 8: 0 = Alarm 3 inactive; 1 = Alarm 3 active Bit 9: 0 = No alarm 3 Ack. required; 1 = Ack. required Bit 10: 1 = Acknowledge alarm 3 Bit 11: Spare Bit 12: 0 = Alarm 4 inactive; 1 = Alarm 4 active Bit 13: 0 = No Alarm 4 Ack. required; 1 = Ack. required Bit 14: 1 = Acknowledge alarm 4 Bit 15: Spare	Uint16	- Read only Read only Read/Write Read only Read only Read/Write Read only Read only Read/Write Read only Read only Read/Write	FB82 (64386)	1

4.3.13 Counters

INTRODUCTION

The virtual channels option introduces a user-configurable number of counters, which can be preset, disabled, incremented or decremented by Job action. If access is permitted, the user can preset the counter to a selected value, as and when required, from the configuration page. See [section 4.7](#) for Job details and [section 4.3.22](#) for a description of virtual channels. If the Batch option is fitted ([section 4.3.10](#)), then batches can be started whenever counter 1 changes value, and if this is done, the current value of counter 1 is appended to batch field 1. (Other counters can be selected for Batch initiation, but operation is not guaranteed.)

CONFIGURATION

Figure 4.3.13 shows a typical (enabled) counter configuration page. The page is accessed from the Root menu/Operator/Config menu.

The screenshot shows a configuration menu for Counter 1. The settings are as follows:

- Counter number: 1) Counter 1 (dropdown menu)
- Enable: (checkbox)
- Value: OFF (text field)
- Units: Units (text field)
- Preset: 0 (text field)
- Buttons: Preset now
- Descriptor: Counter 1 (text field)
- A/B Switching: (checkbox)
- Scale Low: 0 (text field)
- Scale High: 1 (text field)
- Zone Low: 0 (text field)
- Zone High: 100 (text field)
- Scale Type: None (dropdown menu)
- Colour:  (color selection)
- Alarm Number: 1 (dropdown menu)
- Enable: Off (dropdown menu)
- Job Number: 1 (dropdown menu)
- Category: No Action (dropdown menu)
- Buttons: Apply, Discard

Figure 4.3.13 Typical Counter configuration menu

CONFIGURABLE PARAMETERS

Counter number	Allows any of the available counters to be selected for configuration
Enable	Allows the user to start/stop counting by enabling/disabling the counter.
Value	Shows the current dynamic value of the counter
Units	Allows a text string of up to 5 characters to be entered as a units description
Preset	Allows a counter value to be entered for manual or job action preset.
Scale low/high	The values to appear at the scale end points. If A/B switching is enabled, a second set of scale low and scale high values can be entered. 'A' values are used during normal operation. 'B' values are switched to by job action, as described in section 4.7 .

The remaining configuration items are as described for input channels in [section 4.3.3](#), except that Log/Linear scales are not available.

Note: An absolute high alarm (for example) with a threshold of 10, will not be triggered until the value exceeds 10 (i.e. counter value = 11). In order to trip the alarm at 10, a threshold lower than 10 must be entered (e.g. threshold = 9.5). A similar situation exists for absolute low and deviation alarms.

4.3.13 COUNTERS (Cont.)

COUNTER MODBUS ADDRESSING

For units fitted with the Modbus TCP comms option, the table below gives addresses for counter 1 configuration data. Generally: Counter N parameter address = counter 1 parameter address + 162 (N-1) (decimal). For full details of the Modbus implementation, see [section 8](#).

COUNTER CONFIGURATION DATA

COUNTER 1

Parameter Name	Description	Type	Access	Start Addr. Hex (Dec)	Register Length
Span high	Upper span value (display full scale)	Scaled	Read only	8EDD (36573)	1
Span low	Lower span value (display 'zero')	Scaled	Read only	8EDE (36574)	1
Zone high	Zone high value (two decimal places)	Scaled	Read only	8EDF (36575)	1
Zone low	Zone low value (two decimal places)	Scaled	Read only	8EE0 (36576)	1
PV type	Input type 1 = Analogue input 3 = Totaliser 2 = Maths 4 = Counter	Enum	Read only	8EE1 (36577)	1
Decimal places	Number of decimal places (0 to 9) (used by all scaled parameters except where stated)	Uint16	Read only	8EE2 (36578)	1
Colour	Channel colour (0 to 55) (See Annex B for RGB definitions)	Enum	Read only	8EE3 (36579)	1
Units	Units string (up to five characters)	String_5	Read only	8EE4 (36580)	3
Spare				8EE7 (36583)	2
Open string	Open Digital Input string (up to eight characters)	String_8	Read only	8EE9 (36585)	4
Spare				8EED (36589)	4
Close string	Closed Digital Input string (up to eight characters)	String_8	Read only	8EF1(36593)	4
Spare				8EF5 (36597)	4
Descriptor	Channel descriptor (up to 20 characters)	String_20	Read only	8EF9 (36601)	10
Spare				8F03 (36611)	10
No of alarms	Number of alarms on this channel	Uint16	Read only	8F0D (36621)	1
PV format	0 = Numeric 1 = Digital strings	Enum	Read only	8F0E (36622)	1
Spare				8F0F (36623)	60
Alarm 1 enable	Alarm 1 enable 0 = Off 2 = Latched 1 = Unlatched 3 = Trigger	Enum	Read only	8F4B (36683)	1
Alarm 1 type	Alarm 1 type 0 = Absolute low 1 = Absolute high 2 = Deviation in 3 = Deviation out 4 = Rate of change rise 5 = Rate of change fall	Enum	Read only	8F4C (36684)	1
Alarm 1 setpoint	Trigger setpoint (see note)	Scaled	Read/Write	8F4D (36685)	1
Spare				8F4E (36686)	10
Alarm 2 enable	Alarm 2 enable (As alarm 1 enable above)	Enum	Read only	8F58 (36696)	1
Alarm 2 type	Alarm 2 type (As alarm 1 type above)	Enum	Read only	8F59 (36697)	1
Alarm 2 setpoint	Trigger setpoint (see note)	Scaled	Read/Write	8F5A (36698)	1
Spare				8F5B (36699)	10
Alarm 3 enable	Alarm 3 enable (As alarm 1 enable above)	Enum	Read only	8F65 (36709)	1
Alarm 3 type	Alarm 3 type (As alarm 1 type above)	Enum	Read only	8F66 (36710)	1
Alarm 3 setpoint	Trigger setpoint (see note)	Scaled	Read/Write	8F67 (36711)	1
Spare				8F68 (36712)	10
Alarm 4 enable	Alarm 4 enable (As alarm 1 enable above)	Enum	Read only	8F72 (36722)	1
Alarm 4 type	Alarm 4 type (As alarm 1 type above)	Enum	Read only	8F73 (36723)	1
Alarm 4 setpoint	Trigger setpoint (see note)	Scaled	Read/Write	8F74 (36724)	1
Spare				8F75 (36725)	10

Note: If the setpoint source for an alarm ([section 4.3.3](#)) is set to anything other than 'Constant', the value returned is the previously configured constant value.

4.3.13 COUNTERS (Cont.)

RUN-TIME DATA

This table shows addresses for counter 1. Generally: Counter N address = counter 1 address + 3(N-1) (decimal)

COUNTER 1

Parameter Name	Description	Type	Access	Start Addr. Hex (Dec)	Register Length
Value	Current process value (PV)	Scaled	Read only	A47C (42108)	1
Status	Channel status 0 = Good PV 1 = Channel off 2 = Over range 3 = Under range 4 = Hardware error	Enum	Read only	A47D (42109)	1
Alarms	5 = Ranging error 6 = Overflow 7 = Bad PV 8 = No data Alarm information Bit 0: 0 = Alarm 1 inactive; 1 = Alarm 1 active Bit 1: 0 = No alarm 1 Ack. required; 1 = Ack. required Bit 2: 1 = Acknowledge alarm 1 Bit 3: Spare Bit 4: 0 = Alarm 2 inactive; 1 = Alarm 2 active Bit 5: 0 = No Alarm 2 Ack. required; 1 = Ack. required Bit 6: 1 = Acknowledge alarm 2 Bit 7: Spare Bit 8: 0 = Alarm 3 inactive; 1 = Alarm 3 active Bit 9: 0 = No alarm 3 Ack. required; 1 = Ack. required Bit 10: 1 = Acknowledge alarm 3 Bit 11: Spare Bit 12: 0 = Alarm 4 inactive; 1 = Alarm 4 active Bit 13: 0 = No Alarm 4 Ack. required; 1 = Ack. required Bit 14: 1 = Acknowledge alarm 4 Bit 15: Spare	Uint16	- Read only Read only Read/Write Read only Read only Read/Write Read only Read only Read/Write Read only Read only Read/Write	A47E (42110)	1

IEEE 32-BIT CONFIGURATION DATA

The following table gives addresses for the specified 32-bit floating-point values, for Counter 1. Generally, Parameter address for counter N = Parameter address for counter 1 + 36(N-1) (decimal).

COUNTER 1

Parameter Name	Description	Type	Access	Start Addr. Hex (Dec)	Register Length
Span high	Upper span value (Display full scale)	Float	Read only	F48B (62603)	2
Span low	Lower span value (display 'zero')	Float	Read only	F48D (62605)	2
Zone high	Zone upper value (% of 'chart' width)	Float	Read only	F48F (62607)	2
Zone low	Zone lower value (% of 'chart' width)	Float	Read only	F491 (62609)	2
Alarm 1 setpoint	Trigger setpoint for alarm 1 (see note)	Float	Read/Write	F493 (62611)	2
Alarm 2 setpoint	Trigger setpoint for alarm 2 (see note)	Float	Read/Write	F495 (62613)	2
Alarm 3 setpoint	Trigger setpoint for alarm 3 (see note)	Float	Read/Write	F497 (62615)	2
Alarm 4 setpoint	Trigger setpoint for alarm 4 (see note)	Float	Read/Write	F499 (62617)	2
Spare				F49B (62619)	20

Note: If the setpoint source for an alarm (section 4.3.3) is set to anything other than 'Constant', the value returned is the previously configured constant value.

4.3.13 COUNTERS (Cont.)

IEEE AREA COUNTER RUN-TIME DATA

The following table gives addresses for the specified 32-bit floating-point values, for counter 1. Generally, Parameter address for counter N = Parameter address for counter 1 + 4(N-1) (decimal).

COUNTER 1

Parameter Name	Description	Type	Access	Start Addr. Hex (Dec)	Register Length
Counter 1 value	Current process value (PV)	Float	Read only	FC47 (64583)	2
Counter 1 status	Channel status 0 = Good PV 5 = Ranging error 1 = Channel off 6 = Overflow 2 = Over range 7 = Bad PV 3 = Under range 8 = No data 4 = Hardware error	Enum	Read only	FC49 (64585)	1
Counter 1 Alarms	Alarm information Bit 0: 0 = Alarm 1 inactive; 1 = Alarm 1 active Bit 1: 0 = No alarm 1 Ack. required; 1 = Ack. required Bit 2: 1 = Acknowledge alarm 1 Bit 3: Spare Bit 4: 0 = Alarm 2 inactive; 1 = Alarm 2 active Bit 5: 0 = No Alarm 2 Ack. required; 1 = Ack. required Bit 6: 1 = Acknowledge alarm 2 Bit 7: Spare Bit 8: 0 = Alarm 3 inactive; 1 = Alarm 3 active Bit 9: 0 = No alarm 3 Ack. required; 1 = Ack. required Bit 10: 1 = Acknowledge alarm 3 Bit 11: Spare Bit 12: 0 = Alarm 4 inactive; 1 = Alarm 4 active Bit 13: 0 = No Alarm 4 Ack. required; 1 = Ack. required Bit 14: 1 = Acknowledge alarm 4 Bit 15: Spare	Uint16	- Read only Read only Read/Write Read only Read only Read/Write Read only Read only Read/Write Read only Read only Read/Write	FC4A (64586)	1

4.3.14 Timers

INTRODUCTION

This feature supplies 12 count-down timers which can be used for general timing purposes. The timers can be either one-shot or repeating, and can be initiated in the following ways:

1. directly by the operator from the configuration page (if access permission is granted),
2. by job action (see [section 4.7](#)),
3. at a predefined time/date,
4. every 'time period', where the 'time period' can be configured to be anything from 1 second to 1 year. For example, setting seconds to '30' and leaving all other fields 'Any', the timer will start every minute on the half minute. Setting seconds to '30' and minutes to '0' will cause the timer to start at 30 seconds past each hour.

Note: Times are not adjusted for Daylight Saving changes. Thus if the timer is set to trigger on a daily, weekly, etc, basis, then, during 'Summer Time', the trigger will occur an hour late (i.e. at 01:00 hrs. instead of at midnight).

The full range of jobs is described in [section 4.7](#). 'Timer Active' is defined as an internal event trigger ([section 4.3.6](#)).

CONFIGURATION

Figure 4.3.14 shows a typical timer configuration display. The page is accessed from the Root menu/Operator/Config menu.

Timer number 1) Timer 1 ▼ → Select timer

Enable

Remaining 00:00:00

Repeat in 00:00:00

Reset now

Start now

Descriptor Timer 1

Self start

Date Any ▼

Month Any ▼

Hour Midnight ▼

Minute Any ▼

Second Any ▼

Duration 60 Seconds

Repeat after 0 Seconds

Job Number 1 ▼ → Select Job number

Category No Action ▼ → Select Job category

Apply Discard

These fields appear only if 'Self start' is enabled.

Figure 4.3.14 Typical timer configuration page

4.3.14 TIMERS (Cont.)**CONFIGURABLE PARAMETERS**

Timer number	Allows a specific timer to be selected for configuration
Enable	Allows the user to enable/disable the selected timer
Remaining	This is a dynamic display showing the time remaining in hours:minutes:seconds format.
Repeat in	For repeat timers, shows the time remaining before the repeat is initiated. Display is 00:00:00 whilst timer is counting down.
Reset now	Allows a running timer to be reset to 00:00:00.
Start now	Allows the operator to initiate the timer.
Descriptor	Allows a descriptor to be entered for the timer.
Self Start	If enabled, this causes date and time selection fields to appear as shown in figure 4.3.14 above. Date: allows a day number to be selected from a picklist of 1 to N and 'Any', where N is the maximum number of days in the selected month. Month: allows a month number to be entered from a picklist of 1 to 12 and 'Any'. Hour: allows an hour number to be selected from a picklist of 1 to 23, 'Midnight' and 'Any'. Minute: allows a minutes number to be entered from a picklist of 0 to 59 and 'Any'. Seconds: allows a seconds value to be entered from a picklist of 0 to 59 and 'Any'.
Duration	Allows the user to enter a count-down time period in seconds.
Repeat after	Allows the user to enter a repeat rate. It should be noted that the repeat value includes the duration time. For example, to time down from 50 seconds, every minute, a 'Duration' value of 50 seconds should be entered, with a 'Repeat after' value of 60 seconds (not 10 seconds).

Note: If Month = 'Any', and Day = 31, then the timer will not be triggered in February, April, June, September or November. Similarly, if Day = 30, the timer will not be triggered in February, and so on.

Job configuration is as described in [section 4.7](#).

SELF-START EXAMPLE

To preset Totaliser number 1 to zero, daily, at midnight:

In totaliser configuration, enter 0 as the Preset value for Totaliser 1.

In timer configuration, select:

1. Timer number Timer 1
2. Enable enabled
3. Self start enabled
4. Date Any
5. Month Any
6. Hour Midnight
7. Minute 0
8. Second 0
9. Duration 0.125
10. Repeat after 0
11. Job number 1
12. Job category Totaliser
13. Action Preset
14. Totaliser Totaliser 1
15. On Active

4.3.15 Connections

INTRODUCTION

ASCII (INPUT)

Note: See [Section 12](#) for details of the ASCII Printer Output option.

This mode allows the recorder to receive simple ASCII messages from, for example, barcode readers, Programmable Logic Controllers (PLCs), Global Positioning Systems (GPSs) (NMEA-0183 protocol) etc. Messages are sent to as many groups as are set up to receive them, and become a part of these groups' histories, and appear on vertical and horizontal trend displays in the following format:

23/08/05 10:25:06 (Serial), Message of up to 85 characters

23/08/05 10:25:06
(Serial)
Message of up to 85 characters

Date and time
Source
Message

MODBUS RTU

This allows the recorder's serial communications 'port' to be used as Modbus master or Modbus slave. When acting as a master, the unit can communicate with up to 16 slaves. Use of the Serial port is complementary to the use of Ethernet connections.

Note: When configuring a unit as a Modbus slave, it is recommended that the Instrument and Point Configurations give easily identifiable instrument and point names (descriptors).

INSTALLATION

If the option is fitted, two 9-way D-type connectors (plugs) are fitted at the rear of the recorder, as shown in [section 2.2](#).

TERMINATION AND BIASING (Not EIA232)

If the communications line is left open-ended, the end of the cable acts as a reflector, returning what can appear to be 'true' data signals back down the line. A receiver cannot distinguish between 'true' and reflected data, with the result that the 'true' data is corrupted.

In order to avoid this, a termination resistor is fitted across the line at the final instrument. If the value of this resistor is equal to the characteristic impedance of the cable (e.g. 120 Ohms), then the line appears to be of infinite length and no reflections occur. Such a value however, does not always give the best signal-to-noise ratio, so a compromise value (e.g. 220 Ohms) is normally selected to give the optimum performance in reducing unwanted reflections and in improving the signal-to-noise ratio. The recorder communications port is terminated as shown in figure 4.3.15a, below, for a single point-to-point application.

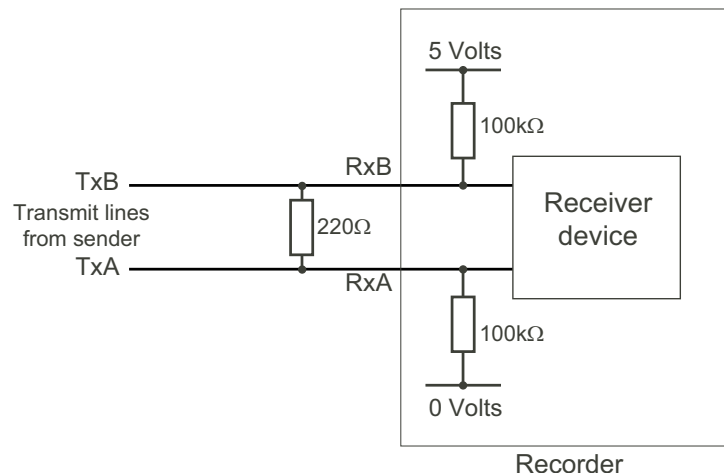

Figure 4.3.15a Recorder termination (single-drop EIA485 application)

4.3.15 CONNECTIONS (Cont.)

CONFIGURATION

The default (ASCII) Serial comms configuration menu is as shown in figure 4.3.15b below. Figures 4.3.15c and 4.3.15d show the alternative menus for Modbus slave and Modbus master selections, respectively. If the ASCII Printer Output option is fitted, a fourth Protocol choice (ASCII Printer) appears - see [section 12](#) for details.

Note: The serial communications hardware is limited to one start bit.

The screenshot shows the Serial Communications configuration menu for ASCII input. The settings are as follows:

- Port: Serial 1 (dropdown menu)
- Link Error Count: 0
- Reset Error Count: (button)
- Protocol: ASCII (input) (dropdown menu)
- Connection: EIA232 (dropdown menu)
- Baud Rate: 19200 (dropdown menu) - Select required Baud rate.
- Stop Bits: 1 (dropdown menu) - Select 1 or 2
- Parity: None (dropdown menu) - Select None, Odd or Even
- Data Bits: 8 (dropdown menu) - Select 7 or 8
- Timeout: 250 ms - Enter required Timeout value
- First Start Char: 0
- Second Start Char: 0
- First End Char: 13
- Second End Char: 10
- Filter:
- Filter 1: GPGLL
- Timeout 1: 600 s
- Filter 2: GPZDA
- Timeout 2: 600 s
- Filter 3: (empty)
- Timeout 3: 0 s
- Group 1:
- Group 2:
- Group 3:
- Group 4:
- Group 5:
- Group 6:
- Buttons: Apply, Discard

Annotations in the image:

- A bracket groups the Start and End Char fields with the text: "Enter decimal ASCII value between 0 and 127. (0 = no character.) See User Guide, (section B6) for list."
- A bracket groups the Filter and Filter 1-3 fields with the text: "ASCII Input Text Filters."
- A bracket groups the Group 1-6 fields with the text: "Select Group(s) to receive messages (✓ = Receive)"

Figure 4.3.15b Serial Communications configuration menu (ASCII input)

4.3.15 CONNECTIONS (CONT.)

Port **Serial 1** Select port

Link Error Count **0**

Reset Error Count

Protocol **Modbus Slave**

Connection **EIA232**

Baud Rate **19200** Select required Baud rate.

Stop Bits **1** Select 1 or 2

Parity **None** Select None, Odd or Even

Apply Discard

Figure 4.3.15c
Serial Communications configuration menu (Modbus master)

Port **Serial 1** Select port

Link Error Count **0**

Reset Error Count

Protocol **Modbus Master**

Connection **EIA232**

Baud Rate **19200** Select required Baud rate.

Stop Bits **1** Select 1 or 2

Parity **None** Select None, Odd or Even

Timeout **1000** ms

Enable error code B

Enable Talk Through

Apply Discard

Figure 4.3.15d
Serial Communications configuration menu (Modbus master)

CONFIGURATION PARAMETERS

SERIAL PORT

Allows the user to select the port to be used for serial communications.

LINK ERROR COUNT

A Link error count is provided for every slave. The count is incremented every time there is a framing error, a parity error or a Cyclic redundancy check (CRC) error. The 'Reset Error Count' key is used to reset the count to zero.

PROTOCOL

For the Serial communications board option, ASCII (input), Modbus Slave, Modbus Master or ASCII Printer protocols are available.

CONNECTION

Allows EIA232 or EIA485 to be selected as transmission standard.

BAUD RATE

Allows a Baud rate to be chosen from a picklist of: 300, 600, 1200, 4800, 9600, 19200, 38400. This value must be the same for all devices in the serial link.

STOP BITS

Selectable as 1 or 2. This value must be the same for all devices in the serial link.

PARITY

Allows Parity to be chosen from a pick list of: None, Odd, Even. This value must be the same for all devices in the serial link.

DATA BITS

For ASCII (input) protocol only, selectable as 7 or 8. This value must be the same for all devices in the serial link.

4.3.15 CONFIGURATION PARAMETERS (Cont.)

TIMEOUT

For ASCII (input) protocol, this allows a timeout value to be entered of between 50 and 3000 msec inclusive. A value of 0 = no timeout. See also 'Messaging Information' below.

For Modbus Master protocol, this allows a timeout to be entered of between 100 and 9,999 msec (inclusive). An error code B is generated (if so configured - see 'Enable Error Code B' below). If the master has not received a reply to a request within the timeout period. For slaves configured with their own timeout periods, these will override the entry here.

MESSAGE START/END CHARACTERS

For ASCII (input) protocol only, the message can be prefixed by 0, 1 or 2 specific characters and can be suffixed by 0, 1 or 2 specific characters. The First and Second Start and End characters are entered as decimal ASCII codes between 0 and 127 as required. 0 = no character, 10 = Line Feed; 13 = Carriage Return. See Annex B for a list of ASCII codes. If only one start or end character is required, the first character must be entered, and the second character be entered as zero.

FILTERS

For information on ASCII input text filters, refer to section 12.3.3.

GROUP SELECTION

For ASCII input protocol, this allows groups to be deselected/selected for receipt of the messages. A checked box indicates that the associated group will receive the messages.

ENABLE ERROR CODE B

For Modbus Master only.

If enabled, this causes an error code B to be generated in the event of a timeout or a Cyclic Redundancy Check (CRC) error.

ENABLE TALK THROUGH

For Modbus Master only.

If disabled, this prevents 'external' (Ethernet) masters from accessing the slaves connected to this instrument. (I.E. only this instrument can act as a master to its slaves.)

MESSAGING INFORMATION

Characters are read into a buffer, until the end of message characters are received, or until the time-since-last-character exceeds the entered Timeout value. Date, Time and '(Serial)' are then prefixed to the message, which is then sent to the selected groups. The date and time relate to when the first buffered character was received. If Start-of-message characters are configured, characters will be read into the buffer only after these characters have been received.

The buffer holds up to 120 characters plus date/time etc. and start/end-of-message characters. Further characters are discarded until End-of-message is received, or timeout occurs.

Message characters below Hex 20 (decimal 32) will be replaced by question marks (?).

Message characters above Hex 7F (decimal 127) will be treated as Unicode.

4.3.15 CONFIGURATION PARAMETERS (Cont.)

MESSAGING RULES

- 1 If no start-of-message characters are configured, but a timeout value other than 0 has been entered, the new message starts after the timeout period has elapsed.
- 2 If no end-of-message characters are configured, but a timeout value other than 0 has been entered, the new message ends after the timeout period has elapsed.
- 3 If start-of-message characters are configured, and a timeout value other than 0 has been entered, all characters prior to the Start-of-message characters are ignored.
- 4 If start-of-message characters are configured but neither end characters nor timeout have been configured, then this is an invalid configuration.
Should this configuration be a requirement, if the same characters are entered as end-of-message characters instead, then each message will be sent to the groups when the next message is received.
- 5 If no start or end-of-message characters are entered and no timeout value is entered, all received characters are discarded
- 6 If a received message is deemed to be corrupt, it is discarded and the software will await a further message.
- 7 Start and End-of-message characters are removed before the messages are sent to the groups.

MODBUS ADDRESS

When acting as a slave, the recorder will respond both to the address set in Instrument Configuration ([section 4.3.1](#)) and to address 255 (used by some network scanning software).

4.3.16 Master comms

INTRODUCTION

This option allows the unit to be used as a Modbus Master unit, as well as a Modbus Slave. The instrument can communicate using the Ethernet (RJ45) connection, or by means of one of the serial communications ports (if fitted - see [section 4.3.15](#) for details) or both simultaneously.

Master Configuration consists of entering a Modbus Address, and, for Ethernet connection, an IP address or DNS path name for each of the available remote devices which are to be used as slaves. The configuration also allows three different priority intervals to be entered, and read/write parameters can be configured to be accessed at one of these three rates.

The unit comes complete with a number of 'Profiles' for known instruments. This allows it to 'recognise' an instrument as a slave type, and simplifies the read/write process for 'known' instruments, by presenting commonly used Parameters by name. Other parameters can be accessed by entering the relevant register's address. The unit will also communicate with 'third party' instruments, but in such a case, the user has to define the required read/write register addresses derived from data supplied by the manufacturer of the instrument.

Once the remote unit has been recognised by the master, the master and slave units can be configured to carry out the following:

1. By setting a master input channel to: Type = 'Master Comms', selected parameters can be read by the master from a selected slave. This master channel can then be included in display groups, can have alarm setpoints, run jobs etc., independently of the original channel. In a similar way, maths functions can be read by setting a master Maths channel to: Function = 'Master Comms'.
2. The 'Demand Write' feature can write values to a selected parameter in a selected slave, as a one-shot update. Demand Writes can be initiated by operator action, or they can be initiated by job action or (if the User Screens option is fitted), by Operator Key action.
3. For slaves whose input and/or maths channels can be set to 'Modbus Comms Input', the master's 'Output channels' feature can copy master input or maths channels to a selected slave, as a continuous process.

Notes

1. If reading from or writing to more than one instrument, it is recommended that some thought be given to instrument and point descriptors, as confusion can easily arise. This is particularly true if Bridge is connected to a master which has several slaves attached.
 2. If 'Link error' occurs whilst connected to a Modbus slave, the slave's delay parameter (if any) should be enabled. If no such parameter is available, the slave's manufacturer should be contacted for advice.
-

An example configuration is given later in this section showing how to set up a master unit to read inputs from two slaves, and to re-write one of these channels to a third slave.

4.3.16 MASTER COMMS (Cont.)

MASTER COMMS CONFIGURATION MENU

A typical master comms configuration page is shown in figure 4.3.16a, below.

Note: For the sake of completeness, the figure below shows all possible fields, even though some are actually mutually exclusive (e.g. 'Login Required' does not appear for 'Profile = Third party').

The screenshot shows the Master Comms Configuration Menu with the following fields and options:

- High Priority interval: 0.125 Seconds
- Medium priority interval: 1 Seconds
- Low priority interval: 2 Seconds
- Store diagnostics:
- Slave: 1) Remote_1 (dropdown)
- Enable:
- Online:
- Descriptor: Remote_1
- Network: Ethernet (dropdown) ← Select 'Ethernet' or Serial port
- IP Address: 149.121.30.0 ← IP Address field appears only if 'Ethernet' selected as Network type.
- Modbus address: 1
- Detect This Slave (button)
- Profile: Third Party (dropdown)
- Timeout: 250 ms
- Retry: 3
- Max Block Size: 124 Register
- Share Socket:
- Login Required: ← Appears only if Profile slave type supports login security
- Username: Username
- Password: *****
- Apply (button)
- Discard (button)
- Detect All Slaves (button)

Additional annotations in the image:

- A bracket groups the Username and Password fields with the note: "Appear only if 'Login Required' is selected".

Figure 4.3.16a Master Comms configuration menu.

CONFIGURABLE PARAMETERS

- | | |
|--------------------|---|
| Priority intervals | This allows three levels of update rate to be entered. These rates are used in point configuration, to define how often a value is read. In order to optimise the performance of the serial link, it is recommended that the slowest rate consistent with requirements be selected. The interval is entered in multiples of 1/8th second (0.125 seconds).
In some cases, two update rates can be defined. For example, when reading a Process Value (PV) channel from a slave, it is possible to set the reading frequency of the PV to the highest rate available, but other, less frequently changing, values (scale low/high for example) can be read at a slower rate. |
| Store Diagnostics | If enabled, diagnostics information is kept in non-volatile memory, and is thus retained during power cycling. |
| Slave | A picklist of slaves, initially called 'Remote Device N'. When the device is detected, this name changes to the detected Instrument's Descriptor (if any) or a default tag. The slave name can be edited in the 'Descriptor' entry field below. |

4.3.16 MASTER COMMS (Cont.)**CONFIGURABLE PARAMETERS (Cont.)**

Enable	If this window is not selected, none of the following fields appears, and the Remote Device cannot be accessed.
Online	If enabled, normal communications with the slave are carried out. When disabled, the connection with the slave is terminated.
Descriptor	Allows a new name for the slave device to be entered. (This name is used only within the master - it does not overwrite the Instrument Descriptor in the slave itself).
Network	Select Ethernet or a Serial port. All the slaves on the link must have the same communications parameter values (e.g. Baud Rate) as are set for the master. See Section 4.3.15 for Serial Communications Configuration details.

Note: Serial ports appear in the selection list only if 'Protocol' has been set to 'Modbus Master' in the Serial Comms Configuration ([section 4.3.15](#)).

IP Address	This field appears only if Network = Ethernet. This must match the IP address or DNS name of the slave. For this unit, this information is to be found in Network/Address and Network/Name respectively. For other instruments, refer to the documentation supplied with those instruments.
Modbus Address	For Ethernet links, Modbus addresses are associated with the IP address. This means that, for any IP address, the range of Modbus addresses used for slaves can (if required) be the same as the range used by a unit with a different IP address. For Serial communications, each unit (including the master) must have a unique Modbus address. For the unit described by this manual, the Modbus address is accessed in 'Instrument' configuration (section 4.3.1). For other instrument the documentation supplied with those instruments should be referred to.
Profile	A pick list of supported instrument types. Third party is used as a default, and for non-listed instrument types. This field is updated automatically if the slave is Detected. (If an instrument is detected and is configured to use more than 100 math channels in the slave instrument - see section 4.3.22).
Timeout	Allows a timeout period to be set for the read/write process. See 'Retry' below, and 'Disable Retries' in section 4.3.17 .
Retry	Allows entry of the number of times the master attempts to get a response from the slave, before aborting. If not successful, an error message appears.
Max Block size	Always 124 for supported instruments, this field is editable for 'Third party' instruments. The maximum block length supported by a particular instrument is found from that instrument's documentation.
Share Socket	This item appears only for slaves with Network = Ethernet. When enabled, allows a reduction in the number of links between a master and multiple slaves. See 'Share Socket', below for more details. Generally, it is recommended that this item is left at the default for the particular slave being configured.
Login Required	Some slaves require a user name and password to be entered before access can be gained. The user name and password set here in the master Comms configuration must match those of the slave. For this type of instrument, the user name is the 'Remote user name' and the password is the 'Remote password' set up in the Security/Access configuration (section 4.4.1). Password is necessary only when Modbus security disabled is not selected in 'Instrument' configuration (section 4.3.1). For other types of instrument, refer to the documentation supplied with that instrument.
Username/Password	See Login Required, immediately above

DETECT THIS SLAVE

This button causes the master to search for the slave set up on this configuration page. If the search is successful, the Remote Device name changes to the instrument name or default tag.

4.3.16 MASTER COMMS (Cont.)

DETECT ALL SLAVES

The screenshot shows a configuration menu for detecting slaves. It includes the following fields and controls:

- Network:** A dropdown menu set to 'Ethernet'.
- Overwrite existing slaves:** A checked checkbox.
- Timeout:** A text input field containing '500'.
- From Node:** A text input field containing '149.121.130.200'.
- For:** A text input field containing '50', with the label 'Node(s)' to its right.
- Modbus Address:** A text input field containing '1'.
- To:** A text input field containing '2'.

At the bottom of the menu are five buttons: 'Abort', 'Start', 'Discard', 'Apply', and 'Re-Scan'.

Figure 4.3.16b Detect all slaves set-up menu

The 'Detect All Slaves' key is used to detect any slaves connected to the system, within certain search parameters.

Operation of the button calls a display page (figure 4.3.16b) which allows the entry of a start IP address, a range of IP addresses, and a range of Modbus addresses. In the above example, the search is carried out for all devices with Modbus addresses in the range 1 to 2 inclusive, associated with instruments which have IP addresses between 149.121.130.200 and 149.121.130.249 inclusive.

PARAMETERS AND KEYS

Network	Allows the user to select a network to search over.
Overwrite existing slaves	The Auto Detect results page (see below) lists all the instruments found within the search parameters, along with a 'tick box' for each one. Each instrument whose tick box is enabled is assigned to the 'Remote Device' list in the Master Comms configuration page. If 'Overwrite existing slaves' is enabled, then newly found instruments will temporarily over write instruments previously configured there. The list becomes permanent when the Modbus configuration page 'Apply' key is operated, but any of the slaves can be edited, if required, prior to this.
Timeout	The search for a slave is aborted if it does not respond within this time, and the search moves on to the next slave.
From Node	The start address for the search
For (nodes)	The number of contiguous addresses to be searched starting with the 'From Node' address.
Modbus Address	The lowest Modbus address for the search. The search will seek all slaves whose Modbus Address lies between the value entered here, and the value entered in the 'To' field, below, inclusive.
To	The highest Modbus address to be included in the search.
Abort	This key allows the user to quit the search
Start	Once the search information has been entered, operation of the Start key causes the unit to search for any instruments which respond to the search criteria.
Discard	Returns to the Modbus configuration page, without saving.
Apply	Saves the details of the detected slaves to the Modbus configuration page. The changes to the configuration page are temporary
Re-scan	Allows the user to repeat the scan, with the same or edited search criteria.

4.3.16 MASTER COMMS (Cont.)

AUTO DETECT PAGE

The 'Autodetect' page displays the progress of the search. Once the search is complete, the results are displayed as shown in figure 4.3.16c, below. For example, the top two lines show that devices with Modbus addresses 1 and 2 were detected at IP address 149.121.130.211.

For instrument types similar to those described in this manual, the Instrument Descriptor is displayed in the list. For other instruments, if the type is recognised, then the instrument type ID (e.g. model number) appears. As can be seen from the figure, the instrument descriptors for the first two detected instruments have been edited (section 4.3.1); the second two have the default descriptor (Instrument), and the final one is a model 2747.

Note: The model number '2747' is used for illustrative purposes only. If such an instrument type exists, it should not be assumed from the above that it will be recognised by the auto detect system.

The screenshot shows the 'Auto Detect' page with a list of detected devices and their Modbus addresses. The first two devices, 'Furnace temps 1' and 'Furnace Temps 2', have their checkboxes checked. The other three devices, 'Instrument at 149.121.130.232/1', 'Instrument at 149.121.130.236/1', and '2747 at 149.121.130.237/1', have their checkboxes unchecked. At the bottom of the page are buttons for 'Abort', 'Start', 'Discard', 'Apply', and 'Re-Scan'. A callout box points to the text 'Please select required slave devices' and explains that this message appears if 'Overwrite existing slaves' is not enabled and the number of detected slaves is greater than the number of free slots. It states that the user must select a maximum of N slave devices, where N is the difference between the number of slaves detected and the number of free slots. If more than N devices are selected, only the first N are used.

Figure 4.3.16c Auto detect results page

As can be seen from the figure above, each instrument has a tick box associated with it. The user enables those instruments which are to be included in the Slave List, by touching the relevant boxes. Operation of 'Apply' then causes the selected instruments to be incorporated into the Slave list in the Modbus Master configuration page.

If 'Overwrite existing slaves' is enabled, existing slaves are overwritten starting with slave 1 in the list.

If 'Overwrite existing slaves' is not enabled, then new slaves selected from the Auto detect page will be inserted into the free slots in the slave list.

Note: A 'free slot' is either an empty slot, or a slot containing a slave which has not yet been enabled.

4.3.16 MASTER COMMS (Cont.)

SHARE SOCKET

This advanced configuration feature is used to improve communications performance, to take advantage of the higher speed of Ethernet links compared with 'Serial' links. It is recommended that the default value (enabled or disabled according to type) be left as despatched from the factory, unless there is good reason to change it.

A socket is the name given to a logical connection between two Ethernet nodes. The establishment and maintenance of sockets is controlled by the recorder, and the user has no control other than to enable or disable the 'Share sockets' facility. The share socket feature is available only for slaves configured as Ethernet devices (i.e. Network = Ethernet).

The upper illustration in figure 4.3.16d, shows master 1 communicating with slaves 1 to n via an Ethernet-to-Serial converter, called a Modbus Gateway. In such a case, it is more efficient to allow all the slaves to communicate over one link between master 1 and master 2, than to establish individual links between master 1 and each of the slaves. In this example, 'Share sockets' should be enabled.

The lower illustration show a similar situation, except that master 2 is not just a gateway, but is a measuring device in its own right. In such a case, Socket 1 is used for high speed communications between master 1 and master 2, and Socket 2 is used to link master 1 to the slaves individually. In this case 'Share Sockets' should be disabled for master 2, and enabled for all other devices.

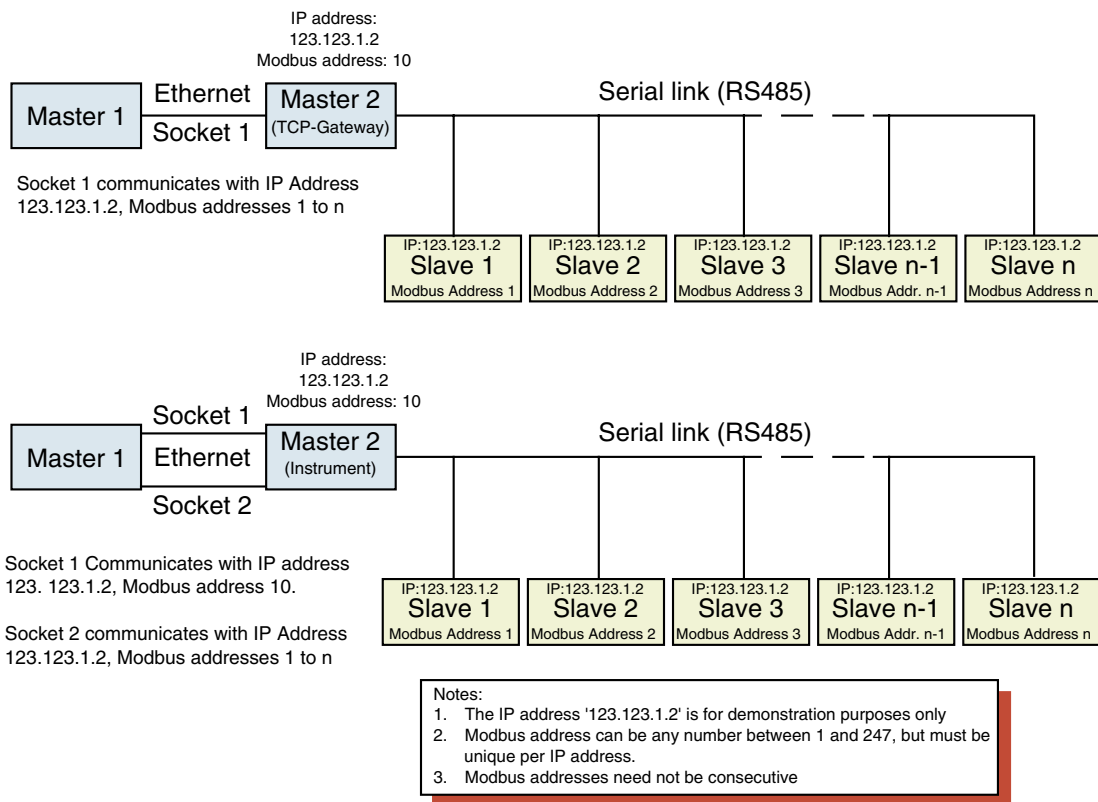

Figure 4.3.16d Share socket examples

4.3.16 MASTER COMMS (Cont.)

MASTER COMMS CHANNEL CONFIGURATION

This display page, shown below, is called from the Operator/Config/Channels as described in section 4.3.3. A similar page appears in the Operator/Config/Maths configuration described in section 4.3.11. The actual picklists which appear, depend entirely on the type or model of instrument being read from. It is assumed that the user knows which parameters are to be accessed.

The following sections describe

- a typical input channel configuration page with 'Master Comms' selected as Input Type, and a recorder or data acquisition unit as slave.
- a typical input channel configuration page with 'Master Comms' selected as Input Type for a slave controller.
- the situation where 'User Defined' has been selected as Parameter. In such a case, the user must determine the required register number from the documentation supplied with the slave.

Note: For completeness, figures 4.3.16e, 4.3.16f and 4.3.16g show all possible configuration fields. The fields that actually appear are slave-model, and parameter dependent.

Channel Number 1) Read 1 ▾ ← Copies descriptor entry

Value -0.4670 Unadjusted

Input Type Master Comms ▾

Slave 1) Furn 1 Recorder ▾ ← Select required slave

Digital

Parameter Process Value ▾ ← Select required slave parameter type

Scaling None ▾ ← Appears only for some slave types

Point Type Channel ▾ } Select Required Slave parameter point

Point Number 1

Process Value Medium Priority ▾ ← Select iteration rate for parameter update

PV Format Numeric ▾

Span Low 0 Units

Span High 1 Units

Zone Low 0 %

Zone High 100 %

Max Decimal Digits 4

Colour 0

Units Units

Descriptor Read 1

Alarm Number 1

Enable Trigger ▾

Apply Discard

Figure 4.3.16e Channel configuration page - Typical Recorder

4.3.16 MASTER COMMS (Cont.)

RECORDER/DAQ CONFIGURABLE PARAMETERS

TYPICAL RECORDER PARAMETERS

The following parameters may be accessible from a recorder or data acquisition unit, depending on model number. Figure 4.3.16e, above, refers

Notes:

1. Items such as Scale, Zone and descriptor may be editable (white background) or not (grey background), depending on model.
2. This description includes only those items which are unique to input channels with Input Type = Master Comms. For other items please see [section 4.3.3](#).

Channel Number	Allows the user to select the number of the channel to be configured. As soon as Modbus master is selected as input type, the display changes from 'Channel 1' (for example) to 'Read 1'. This legend stays as 'Read 1' until a descriptor is entered (below), which immediately overwrites it.
Slave	Allows the user to select (from a picklist), the slave from which data is to be retrieved. The picklist contains all the Remote Devices configured as slaves in the Master Comms Configuration described above.
Digital Parameter	Allows data to be read into a digital input. Allows the user to select Alarm setpoints, Process Value, Batch status (model dependent) or 'User defined' to be selected. 'User defined' allows a (decimal) register address to be entered
Scaling	For some slaves, scale zero (scale low) is returned as value 0 and full scale (scale high) as value 65,535 (Hex FFFF) with intermediate values having proportionate values. For example the value 15, would be represented as 32,767 (7FFF) for a channel scale 0 to 30, as would a value of 50 for a channel scaled 0 to 100, and a value of 45 for a channel scaled 30 to 60. In order to convert this reading to an understandable value, a scaling factor must be entered. If the low and high scale entries match the slave channel's scale, the master reading will be the same as the slave's reading. Selecting 'High/Low' allows Scale low and Scale high values to be entered for the selected parameter. If 'None' is selected, the process value is displayed as a proportion of 64k.
Point type	This item appears for Alarm setpoints and Process Value parameters only. Point type allows the relevant point type (i.e. input channel, maths channel, totaliser etc.) in the slave to be selected.
Point number	This item appears for Alarm setpoints and Process Value parameters only. Point number allows the relevant point number in the slave to be selected. (If an instrument is configured to use more than 100 math channels in the slave instrument - see section 4.3.22).
Group Number	This item appears for Parameter = 'Batch Status' only. Group number allows that group, the status of which is to be read, to be defined.
Process Value	Allows one of three rates to be set for reading the Process Value. The three rates (Low, Medium and High) have the values set in the Master Comms configuration.
Span	Where the input value is scaled (see above), this 'Span' setting sets the Zero and Full Scale values for the channel. This is different from the situation obtaining in input channels, where span and scale have different meanings.

Remaining items are as described in Channel Configuration in [section 4.3.3](#).

4.3.16 MASTER COMMS (Cont.)

TYPICAL CONTROLLER PARAMETERS

The following parameters may be accessible from a controller, depending on type.

Note: Figure 4.3.16f is a typical page and may show more or fewer items than appear on the actual screen for a particular controller

Channel Number 1) Read 1 ▼ ← Reflects descriptor entry

Value -0.4670 Unadjusted

Input Type Master Comms ▼

Slave 1) Furn 1 Control ▼ ← Select Required slave

Digital

Parameter Working Setpoint ▼ ← Select Required slave parameter

Loop Number 1 ← Select required loop parameter

Process Value Medium Priority ▼ ← Select iteration rate for parameter update

PV Format Numeric ▼

Span Low 0 Units

Span High 1 Units

Zone Low 0 %

Zone High 100 %

Max Decimal Digits 4

Colour

Units Units

Descriptor Read 1

Alarm Number 1

Enable Trigger ▼

Apply Discard

Figure 4.3.16f Typical Controller parameter page

4.3.16 MASTER COMMS (Cont.)**TYPICAL CONTROLLER PARAMETERS (Cont.)**

Channel Number	Allows the user to select the number of the channel to be configured. As soon as Modbus Master is selected as input type, this changes from 'Channel 1' (for example) to 'Read 1'. Once communication with the slave is established, this will change to the descriptor of the remote channel (unless the controller type does not support this item, in which case a suitable descriptor can be entered later in the configuration).
Slave	Allows the user to select (from a picklist), the slave from which data is to be retrieved. The picklist contains all the Remote Devices configured as slaves in the Master Comms Configuration described above.
Digital Parameter	Allows data to be read into a digital input. Allows the user to select a specific parameter (table 4.3.16a shows a typical set) or 'User defined' to be selected. 'User defined' allows a (decimal) register address to be entered (see 'User defined', below).
Loop number	Allows the user to enter a Loop Number for the parameter read.
Process Value	Allows one of three rates to be set for reading the Process Value. The three rates (Low, Medium and High) have the values set in the Master Comms configuration.
Span	This 'Span' setting allows the Zero and Full Scale values for the parameter to be entered.
Zone etc.	The remaining items are as described in Channel Configuration in section 4.3.3 .

Alarm status
Auto/Manual
Process value
Read alarm active status
Read alarm unacknowledged status
Working output power
Working setpoint

Table 4.3.16a Typical Controller read parameters

4.3.16 MASTER COMMS (Cont.)

USER DEFINED REGISTERS

As previously mentioned, 'User Defined' can be selected for all slaves and for some slave types it is the only way of accessing some or all parameters.

The number of the register holding the required parameter is to be found in the user documentation supplied with the slave. For instance, if the unit to which this manual refers, were to be a slave, then the list of registers is to be found in [section 8](#). For example, for this instrument, to determine what type of alarm, alarm 1 on channel 2 is, [register 396](#) would be used, and the expected value would be 0 for Absolute low, 1 for absolute high, 2 for Deviation in, 3 for Deviation out, 4 for Rate-of-change high or 5 for Rate-of-Change low.

Channel Number ▼ ← Reflects descriptor, once the Apply key has been operated.

Value Unadjusted

Input Type ▼

Slave ▼ ← Select required slave

Digital

Parameter ▼ ← Select required slave parameter

Function Code ▼ ← Select Function Code

Register ← Enter required register number (decimal)

Data Type ▼ ← Select Data Type

Scaling ▼ ← Select 'None' or 'Decimal Places'

Decimal Places ← Enter No. of decimal point shifts

Process Value ▼ ← Select iteration rate for continuous parameters

PV Format ▼

Span Low Units

Span High Units

Zone Low %

Zone High %

Max Decimal digi

Figure 4.3.16g Configuration page for user defined parameters

4.3.16 MASTER COMMS (Cont.)

CONFIGURABLE PARAMETERS

This section defines those parameters which are unique to user defined registers.

Value	Shows the value returned from the selected register, as modified by the scaling factor (if any).
Function Code	Allows Modbus function code 03 or 04 to be selected. In some implementations, the functions of the two codes are identical. In others, the codes have different functions. See the documentation supplied with the slave for a list of supported Modbus codes. For this instrument see section 8.2.1 .
Register	A decimal number representing the required parameter's location in the slave's Modbus Register map. This information must be determined from the documentation supplied with the slave. For this instrument, section 8.4 contains listings for a number of instrument, groups, and input channels. For details of maths, totalisers etc., refer to the relevant option description.
Data Type	Select a suitable data type for the selected parameter (again from the slave documentation). For this instrument, a list of relevant data types is given in section 8.4 .
Scaling	<p>Whether Scaling appears or not is Model and Parameter dependent. If scaling is required, the choice may be 'Decimal Places, or High/Low, again according to Model.</p> <p>Decimal Places Allows a dividing factor to be entered. An entry of 1, divides the returned value by 10. An entry of 2, divides by 100 etc. for successful implementation, there must be a sufficient number of decimal places defined in the 'Max Decimal Digits' configuration field for the value to be displayed with the required precision. 'None' leaves the returned value unchanged.</p> <p>For some slaves, scale zero (scale low) is returned as value 0 and full scale (scale high) as value 65,535 (Hex FFFF) with intermediate values having proportionate values. For example the value 15, would be represented as 32,767 (7FFF) for a channel scale 0 to 30, as would a value of 50 for a channel scaled 0 to 100, and a value of 45 for a channel scaled 30 to 60. In order to convert this reading to an understandable value, a scaling factor must be entered. If the low and high scale entries match the slave channel's scale, the master reading will be the same as the slave's reading. Selecting 'High/Low' allows Scale low and Scale high values to be entered for the selected parameter.</p> <p>If 'None' is selected, the process value is displayed as a proportion of 65,535.</p>

4.3.16 MASTER COMMS (Cont.)

READING DIGITAL VALUES

Digital values can either be the open/closed status of a discrete input, or it can be a status string showing, for example Instrument Status, if 'User Defined' is selected as Parameter Type,

OPEN/CLOSED STRINGS

The text strings for the open and closed statuses of a digital input channel can be read by 'Enabling' the Digital checkbox for the relevant slave and Channel number. The strings returned will be those entered in the slave channel's configuration.

The default values are representations of an open switch (for Open) and a closed switch (for Closed). Figure 4.3.16h shows these two states.

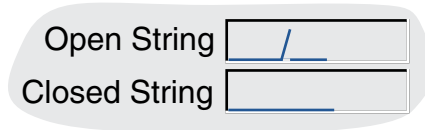

Figure 4.3.16h Default Open/Closed depictions

STATUS BITS

This allows the user to view the value of a bit in a status word such as Instrument Status, Channels in Group etc. The relevant Register is accessed by entering its decimal number into the Register field which appears when 'User Defined' is selected as Parameter.

Example

Figure 4.3.16i, below shows a master channel configuration page which causes a message* to be sent to allgroups if the memory device inserted in a slave recorder is full. Open / closed strings are also entered as Disk OK and DiskFull respectively, so that if this channel is included in a group, then whichever of these legends is appropriate will be displayed in the channel faceplate.

* Note: The message string is entered as a part of Message Configuration as described in [section 4.3.8](#).

From the recorder's documentation, Instrument Status is held at register number 22. As can be seen from table 4.3.16b, disk full status is reported by bit 4.

Bit	Item being tested	Status	Value
0	Not used	Always zero	1
1	Not used	Always zero	2
2	Not used	Always zero	4
3	Card/Disk.	0 = Inserted 1 = Missing	8
4	Card/Disk	0 = Not full 1 = Full	16
5	Not used	Always zero	32
6	Not used	Always zero	64
7	Channel status.	0 = No failures 1 = Channel failure	128

Table 4.3.16b Instrument status (Register 22)

4.3.16 MASTER COMMS (Cont.)

READING DIGITAL VALUES EXAMPLE (Cont.)

Channel Number 1) Card in? ▾
Value Card in
Input Type Master Comms ▾
Slave 1) Recorder ▾
Digital
Parameter User Defined ▾
Function Code Read input reg (4) ▾
Register 22
Data Type Bit (from register) ▾
Bit Position 3
Process Value Medium Priority ▾
Zone Low 75 %
Zone High 100 %
Colour 0
Open String Card in
Closed String Card out
Descriptor Card in?
Alarm Number 1 ▾
Enable Trigger ▾
Type Digital ▾
Active when Card out ▾
Dwell 0 s
Job Number 1 ▾
Category Message ▾
Send Message(s) to All Groups ▾
First Message 1) Card missing ▾
Last Message 1) Card missing ▾
On Active ▾
Apply Discard

Figure 4.3.16i Example configuration page

4.3.16 MASTER COMMS (Cont.)

MASTER COMMS CHANNEL CONFIGURATION EXAMPLE

This example describes a recorder (Furn1 Master) acting as a master to two other recorders (Furn1 Record and Furn2 Record) and a controller (Furn1 Control). This example shows only the configuration pages necessary to set up the master input/output channels and the slave Comms channel. It is assumed that:

- the master comms configuration has been completed with Remote devices 1, 2 and 3 set up as Furn1 Control, Furn1 Record and Furn2 control, respectively.
- all recorders are of the type described in this manual. Other types of slave may need more inputs, or different inputs to be entered.

EXAMPLE (see figure 4.3.16j)

to:

Read Loop1 PV from Controller 1 to Channel 1 of Recorder 1 (the master)

Read Channel 1 from Recorder 2 to Channel 2 of the master

Write Channel 2 of the Master to Channel 1 of Recorder 3.

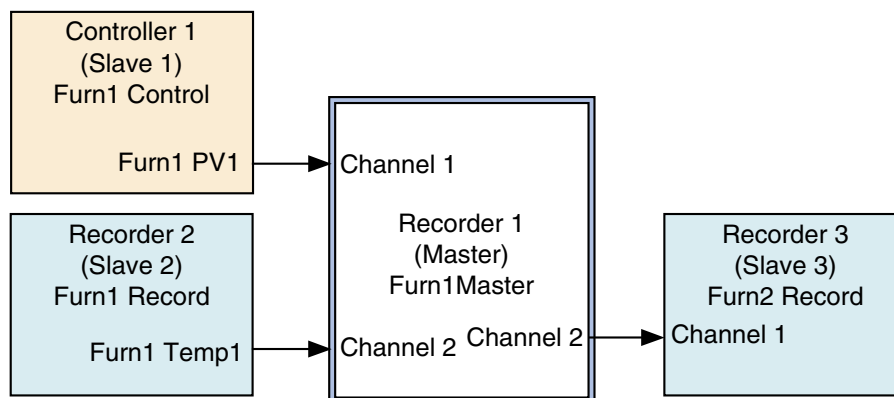

Figure 4.3.16j Required setup

4.3.16 MASTER COMMS (Cont.)

MASTER CHANNEL 1 SETUP

Master channel 1 setup, to read the Loop1 PV from 'Furn1 Control' into channel 1, is shown in figure 4.3.16k, below. Note that, for this example that a Span High of 100 and Descriptor 'Furn1 PV1' have been entered. The span zero and span high values should match those of the PV being read.

Channel Number	1) Furn1 PV1	▼
Value	33.2453	Unadjusted
Input Type	Master Comms	▼
Slave	1) Furn1 Control	▼
Digital	<input type="checkbox"/>	
Parameter	Process Value	▼
Loop Number	1	
Process Value	Medium Priority	▼
PV Format	Numeric	▼
Span Low	0	Units
Span High	100	Units
Zone Low	0	%
Zone High	100	%
Max Decimal Digits	4	
Colour	0	
Units	Units	
Descriptor	Furn1 PV1	
Configuration Data	Low Priority	▼
Alarm Number	1	
Enable	Trigger	▼
	Apply	Discard

Figure 4.3.16k Master Channel 1 setup example

4.3.16 MASTER COMMS (Cont.)

MASTER CHANNEL 2 SETUP

Master channel 2 setup, to read the Channel 1 PV from 'Furn1 record into channel 2', is shown in figure 4.3.16l, below.

Channel Number 2) Furn1 Temp1 ▾
Value 658.3654 Unadjusted
Input Type Master Comms ▾
Slave 2) Furn1 Record ▾
Digital
Parameter Process Value ▾
Point Type Channel ▾
Point Number 1
Process Value Medium Priority ▾
PV Format Numeric ▾
Span Low 0 Units
Span High 1000 Units
Zone Low 0 %
Zone High 100 %
Max Decimal Digits 4
Colour
Units Units
Descriptor Furn1 Temp 1
Configuration Data Low Priority ▾
Alarm Number 1
Enabled
Apply Discard

Figure 4.3.16l Master Channel 2 setup example

4.3.16 MASTER COMMS (Cont.)**MASTER OUTPUT 1 SETUP**

This shows the setup required in order to output the master's channel 2 (Furn1 Temp1) to Furn2 Record channel 1. The Descriptor Furn1 Temp1 has been entered as the Output Name. This happens to be the same as the channel descriptor, but could be any required text string.

Output Channel Number 1) Furn1 Temp 1 ▾
 Enable
 Output Type Master Comms ▾
 Slave 3) Furn2 Record ▾
 Parameter Comms Channel ▾
 Point Type Channel ▾
 Point Number 1
 Process Value Medium Priority ▾
 Descriptor Furn1 PV1
 Source 2) Furn1 Temp1 ▾
 Default 0
 On Error Write Default
 Apply Discard

Figure 4.3.16m Master Output 1 setup example

SLAVE INPUT CHANNEL 1 SETUP

Figure 4.3.16n shows how to set up a slave channel to read an input from a master. Note that the scaling of this channel must match the scaling of the source channel.

Channel Number 1) Furn1 Temp1 ▾
 Value 658.3654 Unadjusted
 Input Type Modbus Comms Input ▾
 Scale Low 0 Deg C
 Scale High 1000 Deg C
 Units Deg C
 Scale Type Linear ▾
 Scale Divisions - Major 10
 Scale Divisions Minor 1
 Descriptor Furn1 Temp 1
 Apply Discard

Figure 4.3.16n Slave channel setup

4.3.16 MASTER COMMS (Cont.)

MASTER COMMS DIAGNOSTICS

Master Comms Diagnostics appears as an additional item on the System Menu. For details of the other items see [section 4.6](#).

Most items are self-evident.

The Total requests and Bad requests totals both exclude retries. The numbers in parentheses are exception code numbers as described in [table 8.2.1b](#).

The Initiate Comms Test is a loop-back test that sends a message to the selected slave and waits for it to be returned. If the test is successful, the 'Successful Comms Test' is incremented. If not successful, one (or more) of the error box values is incremented.

Figure 4.3.16p shows a typical page.

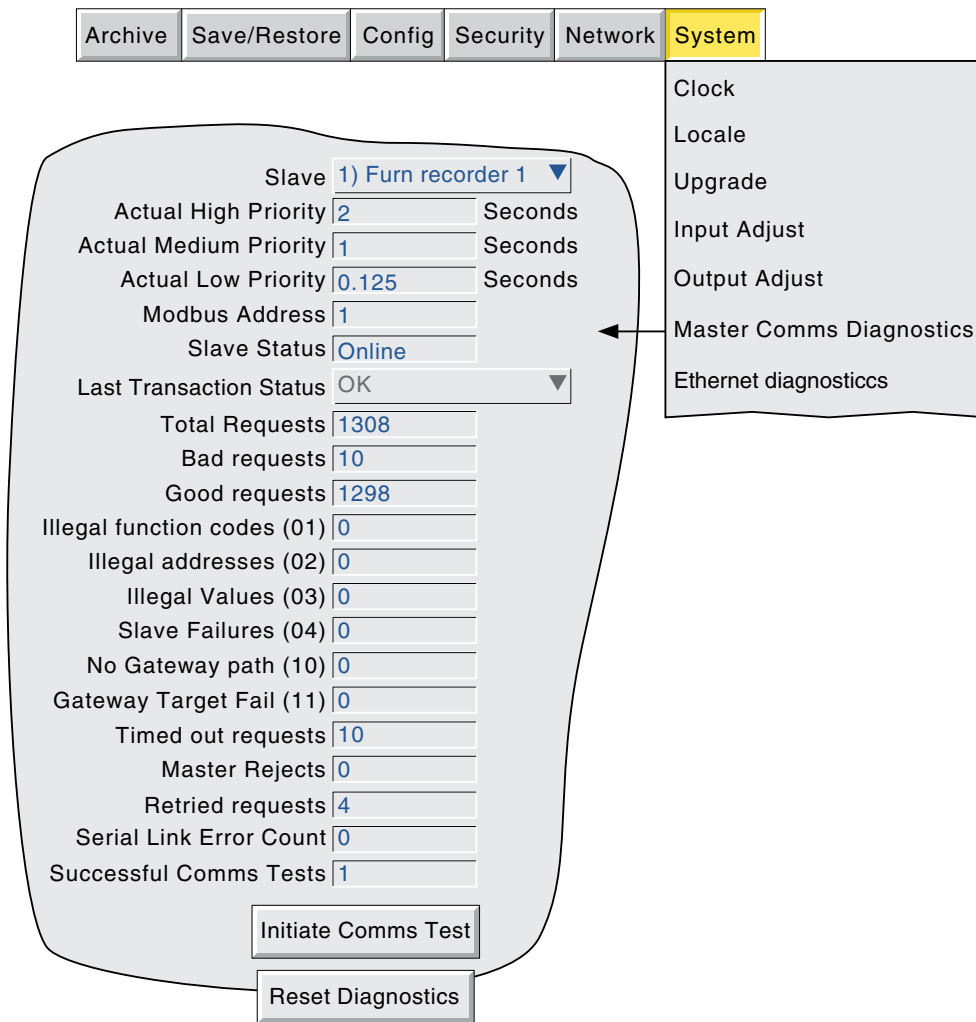

Figure 4.3.16p Master Comms diagnostic page

4.3.17 Output channels

'Output Channels' appears as a configuration item only if either or both of the Master Comms or Analogue outputs options is fitted.

MASTER COMMS

For Master Comms, this feature allows a Master Unit to write one (or more) of its points to one (or more) slaves' channels. Figure 4.3.17a shows a typical configuration page.

Output Channel Number 1) Output 1 ▼

Enable

Output Type Master Comms ▼ Select 'Off', 'Master Comms', 'mA' or 'V'

Slave 1) Furn Recorder 2 ▼

Parameter Comms Channel ▼

Scaling High/Low ▼ Scaling items appear only for some slave types

Scale Low 0

Scale High 100

Point Type Channel ▼ Select destination point

Point Number 1

Process Value Medium Priority ▼ Select iteration rate

Descriptor Output 1

Source 1) Channel 4 ▼ Select source point

Default 0

On Error Write Default

Apply Discard

Figure 4.3.17a Typical output channel configuration page

CONFIGURABLE PARAMETERS

Output Channel Number	Allows the user to select the Output to be configured.
Enable	Allows the output channel to be enabled or disabled.
Output Type	Select Master Comms
Slave	Select the slave to be written-to.
Parameter	Select required parameter from picklist (varies according to slave type/model)
Scaling	If this field appears (depends on slave type), the Low and High scaling should match that of the slave Channel being written to.
Point Type	Allows a point type to be chosen from a picklist. (Picklist items vary according to slave type/model)
Point Number	For recorders, allows a point number to be entered. This point must be configured as 'Comms' or 'Slave Comms' etc. (depending on slave type or model) at the slave.
Loop Number	For Controllers, allows a loop number to be selected from a picklist.
Process Value	Allows the selection of High, Medium or Low priority interval, as defined in the Master Comms configuration page in section 4.3.16.
Descriptor	Allows a descriptor of up to 20 characters to be entered for the output channel name.
Source	This allows the user to select the source point to be written to the slave destination point.
Default	This is the value written, if the source is in 'Error', and the 'On error Write Default' item (below) has been enabled.
On Error Write Default	If this item is enabled, the default value is written instead of the selected Source, if the Source is in 'Error'.

4.3.17 OUTPUT CHANNELS (Cont.)

ANALOGUE OUTPUTS (RETRANSMISSION)

For Analogue outputs, this feature allows the user to direct any recorder point to a pair of rear panel terminals (figure 2.2.1d), either as a voltage signal or as a current signal, as required. Figure 4.3.17 shows a typical configuration page. See section 9 for [Output Adjust](#) details.

Figure 4.3.17b Typical analogue output configuration page

CONFIGURABLE PARAMETERS

Output Channel Number	Allows the user to select the Output to be configured.
Enable	Allows the output channel to be enabled or disabled.
Output Type	Select V or mA
Descriptor	Allows a descriptor of up to 20 characters to be entered for the output channel name.
Range Low	The output which is to appear at the terminals when the source signal is at 'Source span low'.
Range High	The output which is to appear at the terminals when the source signal is at 'Source span high'.
Offset	Allows a fixed value to be entered to the value of the source signal before conversion to the output range.
Source span low	Allows the value of the source signal which is to result in 'Range Low' appearing at the output terminals to be set.
Source span high	Allows the value of the source signal which is to result in 'Range High' appearing at the output terminals to be set.
Data Source	This allows the user to select a point, or a constant to act as the source. If 'Constant' is selected, a further field (not shown in figure 4.3.17b) appears allowing the constant value to be entered.
On Error	Drive Off: the output signal is switched off (0 Volts or 0 mA). Drive High: the output signal is set to Range High + 15%. Drive Low: the output signal is set to Range Low - 15%.

4.3.18 Demand Writes

DEMAND WRITE CONFIGURATION

Demand writes allow slave values to be written from the master by operator action (from the configuration page), by job action, or (if the Screen Builder option is fitted - [section 7](#)) by operation of a suitably configured Operator key. Figure 4.3.18a shows a typical configuration page. Modbus codes 6 and 16 can be selected for this purpose - see [section 8.2.1](#) for code definitions.

Figure 4.3.18a shows a typical configuration page for writing to a recorder. Figure 4.3.18b shows the Edit Constant page. Figure 4.3.18c shows a configuration page for the case where the destination is defined as a register location.

WRITING TO A KNOWN DEVICE

Figure 4.3.18a shows the configuration page for writing a value from the master unit to a 'known' slave unit.

The screenshot shows a configuration page for a demand write. The fields and their values are as follows:

- Write number: 1) Write_1 (dropdown menu)
- Enable:
- Demand Type: Master Comms (dropdown menu)
- Status: OK (text input)
- Slave: 1) Furn 1 Recorder (dropdown menu)
- Parameter: Alarm setpoint 2 (dropdown menu)
- Point Type: Channel (dropdown menu)
- Point Number: 1 (text input)
- Descriptor: Write 1 (text input)
- Source: Constant (dropdown menu)
- Default: 0 (text input)
- Allow Constant Edits:
- On Error Write Default:
- Disable Retries:
- Send On Power Up:

Annotations with arrows point to the following fields:

- Write number: Select the Write number to be configured
- Demand Type: Select 'Master Comms' or 'Off'
- Slave: Select destination slave
- Parameter: Select parameter to be written-to
- Point Type: Select destination
- Default: Enter default value
- Allow Constant Edits: Allows user to edit the constant prior to write (if Source = 'constant')
- On Error Write Default: If enabled, the default value is written, should the selected source be in an 'Error' state.
- Disable Retries: If enabled, the write is attempted only once.
- Send On Power Up: Write is triggered when the unit powers up.

Buttons at the bottom: Apply, Discard

Figure 4.3.18a Typical Demand write configuration page

4.3.18 DEMAND WRITES (Cont.)

CONFIGURABLE ITEMS

Write number	Allows the user to select the Demand Write number to be configured
Enable	Allows the user to enable/disable the write.
Demand Type	Select 'Master Comms' or 'Off'
Status	Shows the status of the transaction. The meaning of most status strings are self-evident, the remaining ones have the following definitions: OK: Transaction was carried out and a satisfactory response has been received Idle: Appears only before the first Write following a power cycle, or if the Write has not previously been configured. Pending: Appears if the Write is waiting to happen, or a response is being waited for. Can appear, for example, if the Write is queued. Timeout: Appears if the slave fails to respond within the timeout set in the Master Comms configuration page. Transaction Disabled: Appears, for example, if the Write has been disabled, but a job is still trying to trigger it.
Slave	Allows the user to select the Slave to be written-to, from a picklist containing all the configured devices in the Master Comms configuration page.
Parameter	Select parameter to be written to (picklist varies according to slave type/model)
Point type/Loop Number/Group Number	Allows a point, loop or group number to be entered for the selected parameter.
Descriptor	Allows a descriptor to be entered for the Write.
Source	Allows the source of the Write to be chosen, from a picklist containing 'Constant' plus all points in the recorder.
Default	Allows a value to be entered for use as a default to be written to the destination point. Appears if 'Source' = 'Constant', or for any other source, if the 'On Error Write Default' checkbox (see below) is enabled.
Allow Constant edits	If this is enabled, the user may change the default value before it is sent. Applies only to user-triggered writes. See 'Demand Write Button', below.
On Error Write Default	Appears for all sources other than 'Constant'. If this function is enabled, then the default value is written, instead of the source value, should the source be in an Error state. When enabled, the 'Default' entry box appears, if it was previously hidden.
Disable Retries	If enabled, this function causes the recorder to attempt the Write only once, instead of retrying according to the number of retries set in the Master Comms Configuration Page.
Send On Power Up	If enabled, this causes the default value to be Written at Power-Up.

DEMAND WRITE BUTTON

When operated, this pushbutton causes the Write to be initiated. If the source is 'Constant' and the 'Allow Constant Edits' item is enabled, an 'Edit' page appears (figure 4.3.18b) allowing the user to change the constant value from its default value, before the Write is carried out. Otherwise, the Write is carried out without any further action being required.

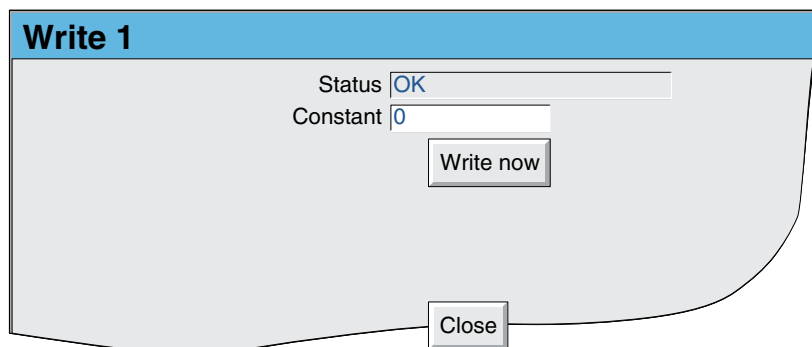

Figure 4.3.18b Constant Edit page

4.3.18 DEMAND WRITES (Cont.)

WRITING TO A SPECIFIC REGISTER

When 'User Defined' is selected, or if the slave device is 'Unknown', then a register can be defined which can be written-to directly. The register addresses must be found from the documentation supplied with the slave device.

The screenshot shows a configuration window for 'Demand Write' with the following settings:

- Write number: 1) Write 1 (dropdown menu)
- Enable:
- Demand Type: Master Comms (dropdown menu)
- Status: Idle (text field)
- Slave: 1) Furn 1 Recorder (dropdown menu)
- Parameter: User Defined (dropdown menu)
- Function Code: Preset Multiple reg (16) (dropdown menu)
- Register: 248 (text field)
- Data Type: Float (32 Bit) (dropdown menu)
- Descriptor: Write 1 (text field)
- Source: Constant (dropdown menu)
- Default: 0 (text field)
- Allow Constant Edits:
- Disable Retries:
- Send On Power Up:

Buttons: Demand Write, Apply, Discard

Figure 4.3.18c Demand Writes to specific register

CONFIGURABLE PARAMETERS

This contains details of parameters unique to Demand Writes to specific registers. Other parameters are as described above.

Function Code	Allows the Modbus function code 6 or 16 to be selected. See the documentation supplied with the slave for a list of supported Modbus codes (for this instrument see section 8.2.1). Demand writes of a single 8 or 16-bit register can use either code, but code 6 is more efficient. Writing two or more registers requires the use of code 16.
Register	A decimal number representing the required parameter's location in the slave's Modbus Register map. This information must be determined from the documentation supplied with the slave. For this instrument, section 8.4 contains listings for a number of instrument, groups, and input channels. For details of maths, totalisers etc., refer to the relevant option description.
Data Type	Select a suitable data type for the selected parameter (again from the slave documentation). For this instrument, a list of relevant data types is given in section 8.4 .

4.3.18 DEMAND WRITES (Cont.)

WRITING TO A SPECIFIC REGISTER (Cont.)

CONFIGURABLE PARAMETERS (Cont.)

Scaling

Whether Scaling appears or not is Model and Parameter dependent. If scaling is required, the choice may be 'Decimal Places, or High/Low, again according to Model. 'Decimal Places' allows a dividing factor to be entered. An entry of 1, divides the returned value by 10. An entry of 2, divides by 100 etc. for successful implementation, there must be a sufficient number of decimal places defined in the 'Max Decimal Digits' configuration field for the value to be displayed with the required precision.. 'None' leaves the returned value unchanged. 'None' leaves the returned value unchanged.

For some slaves, scale zero (scale low) is returned as value 0 and full scale (scale high) as value 65,535 (Hex FFFF) with intermediate values having proportionate values. For example the value 15, would be represented as 32,767 (7FFF) for a channel scale 0 to 30, as would a value of 50 for a channel scaled 0 to 100, and a value of 45 for a channel scaled 30 to 60. In order to convert this reading to an understandable value, a scaling factor must be entered. If the low and high scale entries match the slave channel's scale, the master reading will be the same as the slave's reading. Selecting 'High/Low' allows Scale low and Scale high values to be entered for the selected parameter. If 'None' is selected, the process value is displayed as a proportion of 65,535.

DEMAND WRITES WITH AUDIT TRAIL

Normal Audit Trail messages include both the new value and the previous value, for example

09/08/08 11:27:58 1) Temp1 Alarm Number 1 Enable Latched was Off

With Demand Writes, the recorder has no way of determining what the value, of the parameter being written to, was prior to the Write. For this reason no 'was' value is included in the message. A typical Demand Write audit trail message would be:

09/08/08 11:35:10 Write_1 wrote 255.75

Please see [section 4.4.2](#) for more details of Audit Trail.

4.3.19 E-mails

E-mails can be sent by the instrument to one or more recipients. The user can enter 10 recipient e-mail addresses in each of five mailing lists, giving a maximum of 50 addresses, 10 of which can be sent to at any one time. A Recipient can appear in as many lists as required.

Up to 24 e-mails can be configured, but which of these e-mails is sent, is defined during Job or Event Button configuration. Any function capable of triggering a job, can cause any of the available e-mails to be sent.

As well as a 'Subject', and the body text, each e-mail can include one of the messages set up in 'Message Configuration', and can thus include embedded values, alarm status, batch status etc., as described in [section 4.3.8](#).

E-MAIL CONFIGURATION

The figure below shows the e-mail configuration page (using fictitious names for email server/address information).

The screenshot shows the E-mail configuration page for the SMTP Protocol. The form is organized into several sections:

- Mail Server:** mail server name
- Port Number:** 25
- Sender:** IP Address of Recorder
- Errors To:** e-mail address to which e-mail failure messages to be sent
- Retry Time:** 60 Seconds
- Recipient List:** 1) List1 (dropdown menu with arrow pointing to "Select List Number")
- Descriptor:** List1
- Rcpt1-Rcpt10:** e-mail address of 1st Recipient on this list, e-mail address of 2nd Recipient on this list, etc., and empty fields for Rcpt4 through Rcpt10.
- Email Number:** 1) Email1 (dropdown menu)
- Descriptor:** Email1
- Protocol:** SMTP (Email) (dropdown menu with arrow pointing to "Select SMTP, SMS (Subject Only) or SMS (Body only)")
- Subject:** Cold store alarm
- Text:** Cold store temp. sensor 1 too hot. Instrument name, Instrument number, chan 1Alarm1
- Include Message:**
- Message:** 3) {1},{2},{3},{4} (dropdown menu with arrow pointing to "Select Message Number")

At the bottom of the form are two buttons: **Apply** and **Discard**.

Figure 4.3.19a E-mail configuration (SMTP Protocol)

4.3.19 EMAILS (Cont.)**CONFIGURABLE PARAMETERS**

This subsection contains details of the parameters that appear in the E-mail configuration page (figure 4.3.19a above). Figure 4.3.19b (below) may also be referred-to for further explanation.

Mail Server	Enter the name (note 1) of the mail server or IP address here. This is the destination to which e-mails are sent, for subsequent delivery.
Port Number	This is the port number used for SMTP by the servers. Most servers use port 25 for this function, and this value should be changed from the default only by experienced personnel.
Sender	For DNS operation, this is a combination of the Local Host and Domain entries set up in the 'Network/Name' area of configuration described in section 4.5. If Fixed I.P. Address is selected, the I.P. Address appears instead. The unit accesses the 'Sender' information automatically, and it cannot be edited here. The 'Sender' is placed in the 'From:' part of the e-mail header.
Errors To	An e-mail address to which any error messages can be sent for display etc. The instrument itself cannot receive e-mails and so is unable to display (for example 'undeliverable') messages itself. An entry in this field must be made. The same address may be used for any number of instruments.
Retry time	The product tries repeatedly (until successful) to dispatch the e-mail until the 'Retry time' has expired. If the e-mail has not been sent within this period, it is deleted, and a 'General' message is generated.
Recipient List Descriptor	Allows a list to be chosen for entry of recipient e-mail addresses
Rcpt1 to Rcpt10	Allows a name to be entered for the selected list. These fields allow 10 recipients' e-mail addresses to be entered for the selected list. The first valid address appears in the 'To:' part of the e-mail header; subsequent valid addresses appear in the 'Cc:' part of the e-mail header (note 2).
Email Number Descriptor	Allows an e-mail to be selected for configuration. Allows a descriptor to be entered for the e-mail. This appears in the list of e-mails when setting up a job, and also in the message log.
Protocol	Choose one of 'SMTP (Email)', 'SMS (Subject Only)' and 'SMS (Body Only)'. 'Operation' (below) gives some details of the application of the SMS protocol in this instrument. SMTP (Email). Selecting this protocol allows both a Subject and Body text to be entered. SMS (Subject Only). Selecting this protocol allows a subject to be entered, but the entry field for the body text is not presented for use. Any text previously entered here, whilst another protocol was selected, is lost. SMS (Body Only). Selecting this protocol allows Body text to be entered, but the Subject field is not displayed. Any text previously entered as a Subject, whilst another protocol was selected, is lost.
Subject	Allows the entry of up to 100 characters to appear in the 'Subject:' part of the e-mail header. The field does not appear if 'SMS Body Only' is selected as the Protocol.
Text	Allows the entry of up to 240 characters to appear as the body of the e-mail. The field does not appear if 'SMS Subject Only' is selected as the Protocol. Also referred to as 'Body Text'.
Include message	If this checkbox is enabled, one of the messages in the 'Message Configuration' area can be selected to appear below the body text in the e-mail.

Notes:

1. Domain Name Service (DNS) must be enabled in the recorder network configuration (section 4.5.2) if a mail server name is to be used.
2. A 'general' message is generated if there are any invalid recipients in any list (who would not receive e-mails). Such messages may be viewed in 'Message Log' (section 3.1.4).

4.3.19 EMAILS (Cont.)

E-MAIL DETAILS

Figure 4.3.19b depicts an e-mail using fictitious entries.

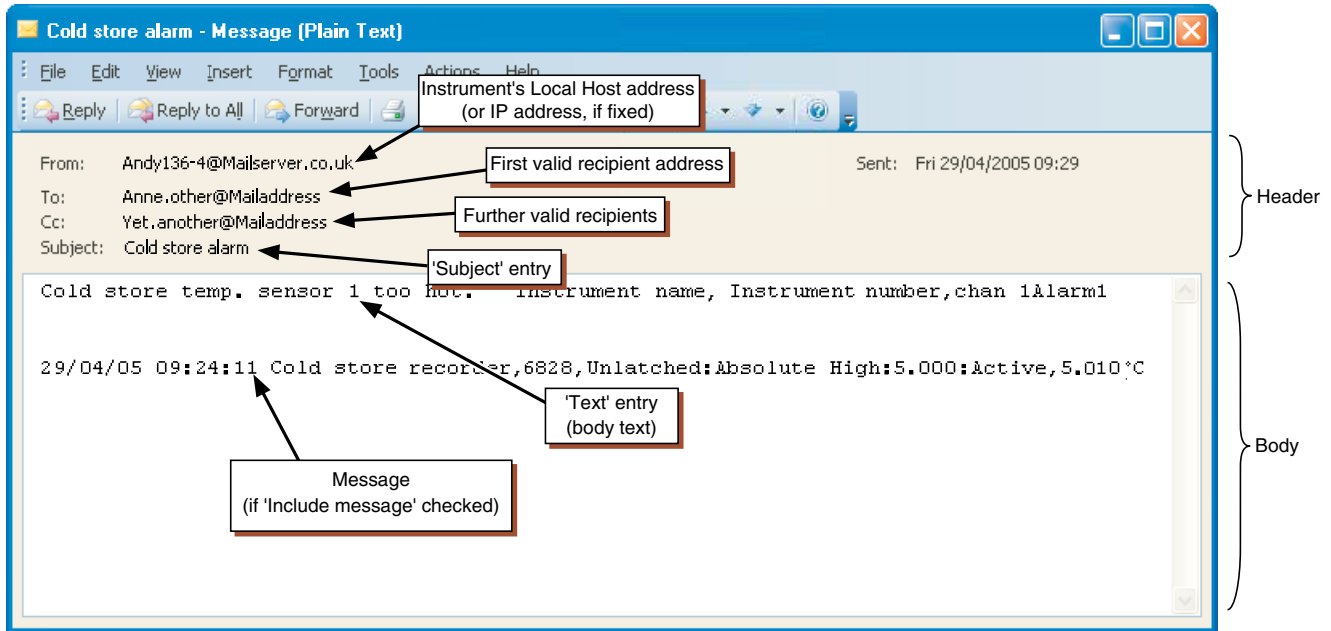

Figure 4.3.19b E-mail appearance

The figure above shows that the e-mail is in two distinct parts, the header (grey area) and the body (white area).

THE HEADER AREA

The header contains details of the sender, the recipient(s), the subject and the time and date.

Note: The time and date may be local to the generating instrument, or local to the recipient, depending on the recipient's mail host configuration

The header is important in the prevention of 'spamming'. The instrument adheres to the RFC2822 standard with respect to e-mail headers. Some servers are stricter than others, and it is not guaranteed that an e-mail generated by the instrument will not be interpreted as a spam message by the receiving server.

From: This contains either the 'Local Host' name (as defined in Network/Name Setup) and mailserver address, or the IP address if a fixed IP address is selected in Network/Address settings. See [section 4.5](#) for details of the Network key.

To: The first valid recipient address in the selected list.

CC: The remaining valid addresses in the recipient list

Subject: Contains the subject text entered during configuration. Empty if 'SMS Body' selected as Protocol

4.3.19 EMAILS (Cont.)

THE BODY AREA

This contains the body text, along with any appended messages. In the example above the message has the embedded values of Instrument name, Instrument number, channel 1 alarm 1 status, as implied by the body text.

OPERATION

1. E-mails are generated either by job or by operation of an [Event Button](#) from a [User screen](#) (if the Screen builder option is fitted).
2. Every time the sending of an e-mail is requested, a 'General' note is generated and appears in the message log for all groups. The format is: Date, Time Sent <e-mail descriptor> to List N, where <e-mail descriptor> represents the descriptor entered in the configuration page for the e-mail, and 'List N' is the recipient list to whom the e-mail was sent.
3. Access to e-mails is restricted to users with 'Full Configuration' permission.
4. Signing/Authorizing restrictions can be applied only to e-mails generated by Event button operation, as part of the Event button's configuration ([section 4.3.7](#)).
5. The instrument implements the Simple Message Transfer Protocol (SMTP), incorporating Multipurpose Internet Mail extensions.
6. The instrument does not implement the Short Message Service (SMS) protocol, though it is able to send SMS messages to a mobile phone via an appropriate server or gateway. As some servers/gateways use the 'subject' as the SMS message, and others use the body text, these alternatives are provided for in the Protocol pick list in the Configuration page described above.
7. A new event source 'Email fail' can be used to trigger a job list should an e-mail send failure occur.

4.3.20 Reports configuration

This allows the user to configure up to 10 'reports' for output to the chart or for printing by an ASCII printer (option) as a result of job action. Figure 4.3.20a shows a typical configuration page, accessed from the CONFIG button 'Reports' item.

Figure 4.3.20a Reports Configuration

REPORT	Allows the user to select the required report number for configuration.
DESCRIPTOR	A name for the Report can be entered here.
NUMBER OF FIELDS	Select 0 to 10 for the number of items to be included in the report.
FIELD N TYPE	N = 1 to the number of fields selected in the previous item.
Date & Time	Causes the time and date of report generation to be included in the report
Text	Allows the user to enter a text message of up to 60 characters.
Process value	Allows a specified point's process value (including descriptor and units) to be included in the report
Batch Field 1	Batch field 1 can be included in the report. See section 4.3.10 for Batch details.
Message	A message can be selected for inclusion in the report. See section 4.3.8 for details of message configuration.
Line Feed	Allows one or more blank lines to be left. This can be useful at the end of a report.

4.3.20 REPORTS CONFIGURATION (Cont.)

Note: The Style, Point and Line feed settings described below apply only to printed outputs and have no effect when presented on the 'chart' or in the message log.

STYLE See figure 4.3.20b for examples of 'Normal', 'Bold', 'Emphasised' and 'Banner' print styles. For all styles, if the text is too long to fit on one line it 'wraps round' as shown (for normal style) in the figure.

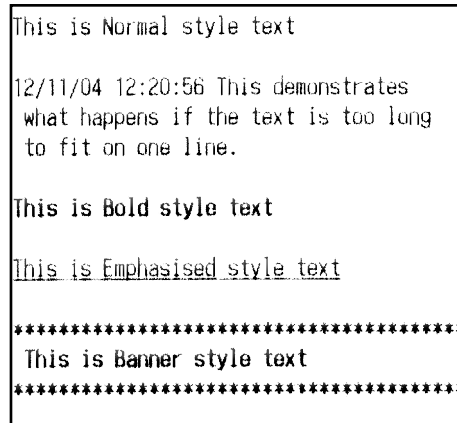

```
This is Normal style text
12/11/04 12:20:56 This demonstrates
what happens if the text is too long
to fit on one line.
This is Bold style text
This is Emphasised style text
*****
This is Banner style text
*****
```

Figure 4.3.20b Printer text style examples

POINT Allows a point to be chosen when 'Process value' has been selected as Field Type. The point is selected from a pick-list containing all the input channels, derived channels, totalisers etc. in the instrument.

LINE FEED Appears only when 'Line Feed' has been chosen as Field Type. Allows the user to enter the required number of blank lines (up to 10) which are to be inserted. Line feeds appear only on printed outputs - not on the 'chart' or in the message log.

Note: See [section 12](#) for printer configuration details

4.3.21 Ethernet/IP™ Option

Note: Full details of Ethernet/IP protocol are available from the ODVA web site <http://www.odva.org>

EtherNet/IP (Ethernet/Industrial Protocol) is a 'producer-consumer' communication system used to allow industrial devices to exchange time-critical control data. Such devices range from simple I/O devices such as sensors/actuators, to complex control devices such as robots and PLCs. The producer-consumer model allows the exchange of information between a single sending device (producer) and a large number of receiving devices (consumers) without having to send data multiple times to multiple destinations.

EtherNet/IP makes use of the CIP (Control & Information Protocol), common network, transport and application layers currently implemented by DeviceNet and ControlNet. Standard Ethernet and TCP/IP technology is used to transport CIP communications packets. The result is a common, open application layer on top of Ethernet and TCP/IP protocols.

In order to record and trend data that has been written by the client, the relevant channel or maths channel must be configured with 'Input Type' set to 'Ethernet/IP Comms Input' and the channel must be included in a Recording-enabled group. See sections, 4.3.2 (Group configuration), 4.3.3 (Channel configuration) and 4.3.11 (maths configuration) as necessary.

MESSAGING

Ethernet/IP uses two forms of messaging:

UNCONNECTED MESSAGING

This is used in the connection establishment process and for infrequent, low-priority messages. The unconnected resources in a device are called the 'Unconnected Message Manager' (UCMM).

CONNECTED MESSAGING

This uses resources within each node that are dedicated, in advance, to a particular purpose, such as frequent explicit message transactions or real-time I/O data transfers. Connection resources are reserved and configured using communications services available via the UCMM.

The process of opening a connection is called 'Connection Origination'. The node that initiates the connection establishment request is called the 'Connection Originator' (or 'Originator') and the node that responds to the establishment request is called a 'Connection Target' (or 'Target'). Ethernet/IP has two types of messaging connections:

EXPLICIT MESSAGING CONNECTIONS

These are point-to-point relationships that are established to facilitate request-response transaction between two nodes. These connections are general purpose in nature and can be used to reach any network-accessible items within a device. Explicit messaging connections use TCP/IP services to move messages across Ethernet.

IMPLICIT (I/O DATA) CONNECTIONS

These are established to move application-specific I/O data at regular intervals. These connections are typically set up as one-to-many relationships in order to take full advantage of the producer-consumer multicast model. Implicit messaging uses UDP/IP resources to establish multicast data.

4.3.21 ETHERNET/IP OPTION (Cont.)

CONFIGURATION

Figure 4.3.21a shows the configuration page.

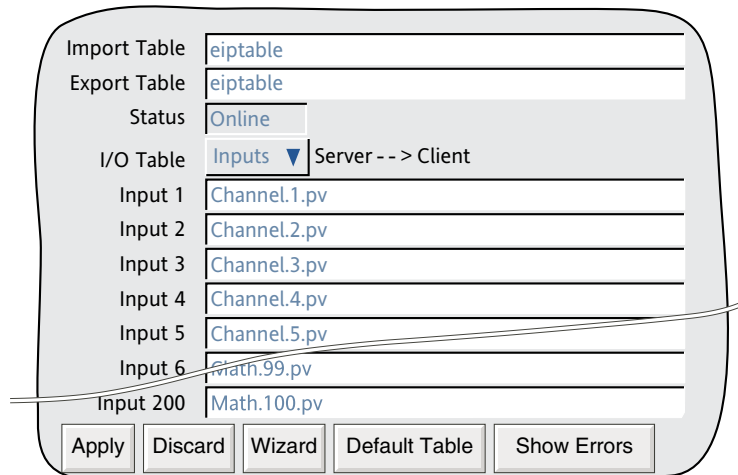

Figure 4.3.21a Ethernet/IP option configuration (large frame unit)

Import Table	Touching this field opens the file window, allowing the user to select a .uht file for import. This file may be a file previously exported using the 'Export table' field, in which case it will be found in the \user\ folder, or it may be located on a USB stick or other memory device, in which case it will appear in a separate folder.
Export Table	This allows the user to export the current table to the instrument's flash memory or to a memory stick or other memory device. Exported tables may be imported into other suitable instruments, or into a pc to be used as a 'template' for creating other tables.
Status	Initialising: Initial status at start-up. Switches to 'Online' when the Ethernet/IP configuration has been read successfully and the server has completed its configuration. Online: All cyclic inputs and outputs are updated continuously Offline: The server ignores all transactions and tables are not updated.
I/O Table	Select 'Inputs' (Server -->Client) or 'Outputs' (Client --> Server) for the displayed table.
Input (output) 1	Shows the first selected input (output) parameter which is to be read or written. Input tables can be completed by importing a suitable previously configured table, by entering individual parameters into each field, by using the Wizard key or by using the Default table and editing it as necessary. See 'Table entry', 'Wizard key' and/or 'Default table', below for further details. Output tables cannot be edited
Input (output) 2 to 200	As for input (output) 1, above, but for the remaining table entries.
Apply key	Touch this to save the table configuration. An error message is generated if the channel number is out of range, or if the syntax is incorrect. See 'Table entry', below.
Discard key	Touching this key causes all changes made since the previous 'Apply' to be discarded.
Wizard key	This provides a mechanism for the rapid entry of input and output table parameters. See ' WIZARD ' below for a fuller explanation.
Default Table key	Fills the displayed input or output table with channel and math PV parameters. This can then be edited either on an entry by entry basis, or by exporting the table so that it may be edited in a pc. Described in more detail later .
Show Errors key	Shows any errors in the current configuration. For each parameter without error, the parameter's Modbus address is displayed instead.

4.3.21 ETHERNET/IP OPTION (Cont.)**TABLE ENTRY**

The normal text entry techniques can be used to enter parameters into the Input table. The following syntax must be used, or an error message will be generated when 'Apply' is operated and the configuration will remain unchanged:

Notes:

1. The syntax is not case sensitive; for example, it may be 'Channel', or 'channel' or 'CHANNEL'.
2. Channels 1 to 18 (small frame) and 1 to 48 (large frame), may be configured as measuring channels or as Ethernet/IP comms input channels. The remaining channels, up to 100, must be configured as Ethernet/IP Comms input channels. For channels 76 to 100, only 'pv' is supported.

Channel.n.pv	Channel 'n' process value where 'n' = 1 to 100 - see note 2 above.
Channel.n.status	Channel 'n' status, where 'n' = 1 to 75 - see note 2 above.
Channel.n.spanhi	The Span High value for channel 'n', where 'n' = 1 to 75 - see note 2 above.
Channel.n.spanlo	The Span Low value for channel 'n', where 'n' = 1 to 75 - see note 2 above.
Channel.n.dp	Number of decimal places for channel 'n', where 'n' = 1 to 75 - see note 2 above.
Channel.n.pvIEEElo	Channel 'n' Process Value IEEE low, where 'n' = 1 to 100 - see note 2 above.
Channel.n.pvIEEEhi	Channel 'n' Process value IEEE hi, where 'n' = 1 to 100 - see note 2 above.
Channel.n.spanloIEEElo	The Span Low IEEE low value for channel 'n', where 'n' = 1 to 75 - see note 2 above.
Channel.n.spanloIEEEhi	The Span Low IEEE high value for channel 'n', where 'n' = 1 to 75 - see note 2 above.
Channel.n.spanhiIEEElo	The Span high IEEE low value for channel 'n', where 'n' = 1 to 75 - see note 2 above.
Channel.n.spanhiIEEEhi	The Span high IEEE high value for channel 'n', where 'n' = 1 to 75 - see note 2 above.
Math.n.pv	Maths channel 'n' process value where 'n' = 1 to 100.
Math.n.status	Maths channel 'n' status, where 'n' = 1 to 100.
Math.n.spanhi	The Span High value for maths channel 'n', where 'n' = 1 to 100.
Math.n.spanlo	The Span Low value for maths channel 'n', where 'n' = 1 to 100.
Math.n.dp	Number of decimal places for maths channel 'n', where 'n' = 1 to 100.
Math.n.pvIEEElo	Maths channel 'n' Process Value IEEE low, where 'n' = 1 to 100.
Math.n.pvIEEEhi	Maths channel 'n' Process Value IEEE high, where 'n' = 1 to 100.
Math.n.spanloIEEElo	The Span Low IEEE low value for maths channel 'n', where 'n' = 1 to 100.
Math.n.spanloIEEEhi	The Span low IEEE high value for maths channel 'n', where 'n' = 1 to 100.
Math.n.spanhiIEEElo	The Span high IEEE low value for maths channel 'n', where 'n' = 1 to 100.
Math.n.spanhiIEEEhi	The Span high IEEE high value for maths channel 'n', where 'n' = 1 to 100.

4.3.21 ETHERNET/IP OPTION (Cont.)

ERROR MESSAGES

If an error is made during editing, a brief description of the error can be viewed by operating the 'Show Errors' key:

- ?Out of Range this means that the channel or maths number is greater than the maximum given in the description above (e.g. channel 101)
- ?Syntax Error There is an error in capitalisation, or commas have been used instead of full stops (periods) or some other text error has been made.
- ?Unsupported Data A suffix implying a data type which is not supported by this implementation of Ether-Net/IP has been appended. (Example: Channel.4.alm).

If the 'Apply' key is operated whilst there are uncorrected errors, a message appears showing the number of first input in which a fault has been found. The user must correct the fault and operate 'Apply' again in order to save the configuration. If there are further errors, the message reappears showing in which input the next error lies (Input two in the figure below).

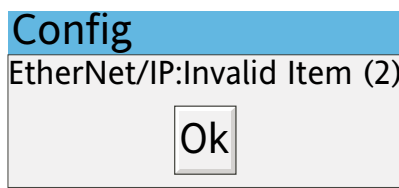

Figure 4.3.21b Error message

Note: The 'Show Errors' key allows the user to view all current configuration errors at the same time. In this display, each valid parameter displays its associated Modbus address, but any error channels display an error message instead.

UHT FILE RULES

1. Table configuration files must have the extension '.uht'
2. The first line must be: HEADER,ETHERNET_IP_SERVER,1
3. Subsequent lines may be comments (preceded with a # character and terminated with a Carriage return) or a configuration item in the <point type>.<point number>.<suffix> as described in 'Table Entry' above.

WIZARD

The wizard offers a quick and easy way of loading the Input Table by touching the required point parameters and then entering start and end values for the range of points to be included. For current software, the Output table is not editable, so any changes made in the Wizard are ignored.

4.3.21 ETHERNET/IP OPTION (Cont.)

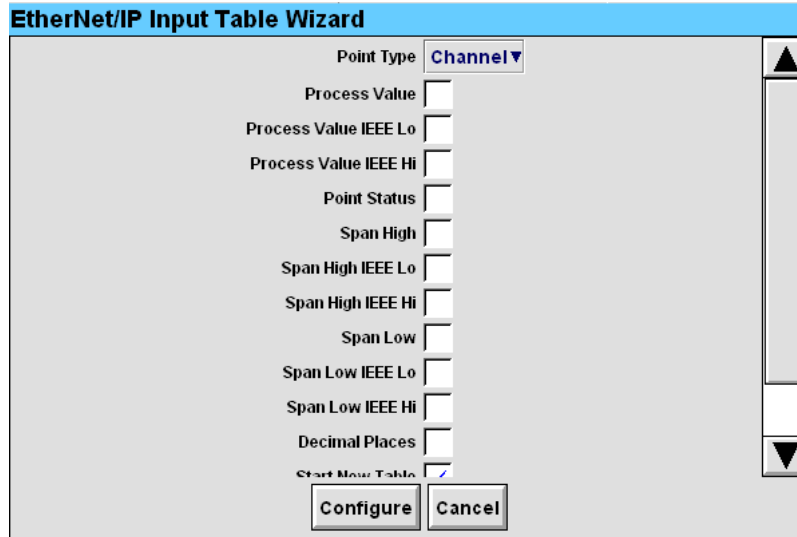

Figure 4.3.21c Input table wizard

Point Type	Select 'Channel' or 'Math' for configuration. The 'Configure' key must be operated before changing from 'Channel' to 'Math' or vice-versa, as only the configuration for the currently displayed Point Type (i.e. Channel or Math) is saved to the Input table.
Process Value	Select to include Process Value
Process Value IEEE Lo	Select to include Process Value IEEE Low (32Bit Float access)
Process Value IEEE Hi	Select to include Process Value IEEE Hi (32Bit Float access)
Point Status	Select to include Point Status (not supported for channels 76 to 100)
Span High	Select to include Span High (not supported for channels 76 to 100)
Span High IEEE Lo	Select to include Span High IEEE Low (32Bit Float access) (not supported for channels 76 to 100)
Span High IEEE Hi	Select to include Span High IEEE Hi (32Bit Float access) (not supported for channels 76 to 100)
Span Low	Select to include Span Low (not supported for channels 76 to 100)
Span Low IEEE Lo	Select to include Span Low IEEE Low (32Bit Float access) (not supported for channels 76 to 100)
Span Low IEEE Hi	Select to include Span Low IEEE Hi (32Bit Float access) (not supported for channels 76 to 100)
Decimal Places	Select to include the points' decimal places values (not supported for channels. 76 to 100)
Start New Table	If ticked (default), the existing list is deleted and replaced by the Wizard items when 'configure' is operated. If not ticked, the selected items are appended to the existing table, using any empty spaces. If there are no spaces, the new entries are ignored. If there are insufficient spaces, the available spaces are filled using lowest channel numbers first, and any overflow is lost.
From point	Enter the number of the first point of the required point range. This value must be lower than the 'To point' value.
To point	Enter the number of the final point of the required point range This value must be higher than the 'From point' value..

Notes:

1. The point range is the same for all parameters selected, and the points are contiguous. In order to select non-contiguous points, or to enter different ranges for different point types, it is necessary to configure each required range separately and operate the 'Configure' key after each range, ensuring that the 'Start New Table' selection is not ticked.
2. If any parameter other than 'Process Value' is selected for any channel in the range 76 to 100, the selection will be accepted, but the values returned will be meaningless.

4.3.21 ETHERNET/IP OPTION (Cont.)**DEFAULT TABLE KEY**

Clicking on this key causes the relevant table to be populated with a default set of parameters.

For input tables, these parameters are: Channel.1.pv to Channel.100.pv followed by Math.1.pv to Math.100.pv.

The output table parameters are: Channel.1.pv to Channel.100.pv followed by Math.1.pv to Math.100.pv.

SHOW ERRORS KEY

Clicking on this key causes the parameter addresses to appear after the parameter names in the input and output tables. If a syntax or other error has been made in loading the input table, a description of the error type appears in this view (see '[ERROR MESSAGES](#)', above).

OUTPUT TABLE PARAMETER MODBUS ADDRESSES

In all cases, the addresses for the output parameters can be viewed by operating the 'Show errors' key. The addresses for channels 1 to 75 and maths 1 to 100 can be found as described in [Section 8.4.3](#) (Channel Runtime data), and [section 4.3.11](#) (Maths channel Run-time data). Addresses for channels 76 to 100, are given below:

Parameter Name	Description	Type	Access	Start Addr. Hex (Dec)	Register Length
Channel.76.pv	Channel 76 process value	Scaled	Read only	FCBF (64703)	1
Channel.77.pv	Channel 77 process value	Scaled	Read only	FCC2 (64706)	1
Channel.78.pv	Channel 78 process value	Scaled	Read only	FCC5 (64709)	1
Channel.79.pv	Channel 79 process value	Scaled	Read only	FCC8 (64712)	1
Channel.80.pv	Channel 80 process value	Scaled	Read only	FCCB (64715)	1
Channel.81.pv	Channel 81 process value	Scaled	Read only	FCCE (64718)	1
Channel.82.pv	Channel 82 process value	Scaled	Read only	FCD1 (64721)	1
Channel.83.pv	Channel 63 process value	Scaled	Read only	FCD4 (64724)	1
Channel.84.pv	Channel 64 process value	Scaled	Read only	FCD7 (64727)	1
Channel.85.pv	Channel 65 process value	Scaled	Read only	FCDA (64730)	1
Channel.86.pv	Channel 66 process value	Scaled	Read only	FCDD (64733)	1
Channel.87.pv	Channel 67 process value	Scaled	Read only	FCE0 (64736)	1
Channel.88.pv	Channel 68 process value	Scaled	Read only	FCE3 (64739)	1
Channel.89.pv	Channel 69 process value	Scaled	Read only	FCE6 (64742)	1
Channel.90.pv	Channel 70 process value	Scaled	Read only	FCE9 (64745)	1
Channel.91.pv	Channel 71 process value	Scaled	Read only	FCEC (64748)	1
Channel.92.pv	Channel 72 process value	Scaled	Read only	FCEF (64751)	1
Channel.93.pv	Channel 73 process value	Scaled	Read only	FCF2 (64754)	1
Channel.94.pv	Channel 74 process value	Scaled	Read only	FCF5 (64757)	1
Channel.95.pv	Channel 75 process value	Scaled	Read only	FCF8 (64760)	1
Channel.96.pv	Channel 76 process value	Scaled	Read only	FCFB (64763)	1
Channel.97.pv	Channel 77 process value	Scaled	Read only	FCFE (64766)	1
Channel.98.pv	Channel 78 process value	Scaled	Read only	FD01 (64769)	1
Channel.99.pv	Channel 79 process value	Scaled	Read only	FD04 (64772)	1
Channel.100.pv	Channel 80 process value	Scaled	Read only	FD07 (64775)	1

Table 4.3.21 Parameter addresses for channels 76 to 100

CONFIGURING A PLC

The following instructions describe how to configure a PLC to communicate with a Paperless graphic recorder. Although a specific PLC was used in generating these instructions, the detail should be general enough to allow any other PLC to be used.

INSTALLATION

1. Install the PLC software according to the instructions supplied with the PLC. For this particular PLC, once installation is complete, the 'RSLinx Classic' and 'RSLogix 5000' software items (AMONGST OTHERS) must be present. RSLinx classic is used to provide a link between the PLC network and Windows, and RSLogix 5000 is configuration and programming software for the PLC.
2. Use a cross-over type serial cable to connect one of the pc ports to the serial port (typically a 9-way D-Type connector) of the PLC
3. Connect an Ethernet cable between the Ethernet port on the PLC (typically an RJ45 socket) and the recorder. If a direct connection is used, the cable must be a cross-over type; if connecting via a switch, then non cross-over cable must be used.
4. Power up the PLC and the Recorder. Switch the PLC to 'Programmer' mode.

Continue to ["SETTING UP THE LINK BETWEEN WINDOWS AND THE PLC NETWORK"](#).

4.3.21 ETHERNET/IP OPTION (Cont.)

SETTING UP THE LINK BETWEEN WINDOWS AND THE PLC NETWORK

1. Click on Start/All Programs/Rockwell software/RSLinx/RSLinx Classic. The 'RSLinx Classic' window opens.
2. Click on 'Communications' and select 'Configure Drivers'. When the 'Configure Drivers' window opens, select 'RS232 DF1 devices' in the 'Available Drive Types' pull down menu (figure 4.3.21d).
3. Click on 'Add New' and enter a suitable Driver Name in the pop-up window that then appears. Click on 'OK'. The 'Configure RS-232 DF1 devices' window opens (figure 4.3.21e).
4. In the 'Device:' field pull-down menu, select the relevant device name. Select the PC COM port, and the relevant Baud Rate, Parity etc. (normally the defaults are acceptable). Click on 'Auto-Configure'.
5. When the Auto-Configure process is complete, click on 'OK', to close the 'Configure Drivers' window, and then minimise the 'RSLinx Classic' window.
6. Start the RSLogix 5000 program (from 'Start/All programs/... /RSLogix 5000). When the 'Quick Start' window opens, close it.
7. At the top of the RSLogix 5000 window, click on the 'Who active' icon  or click on 'Who Active' in the 'Communications' drop down menu. The 'Who Active' window opens.

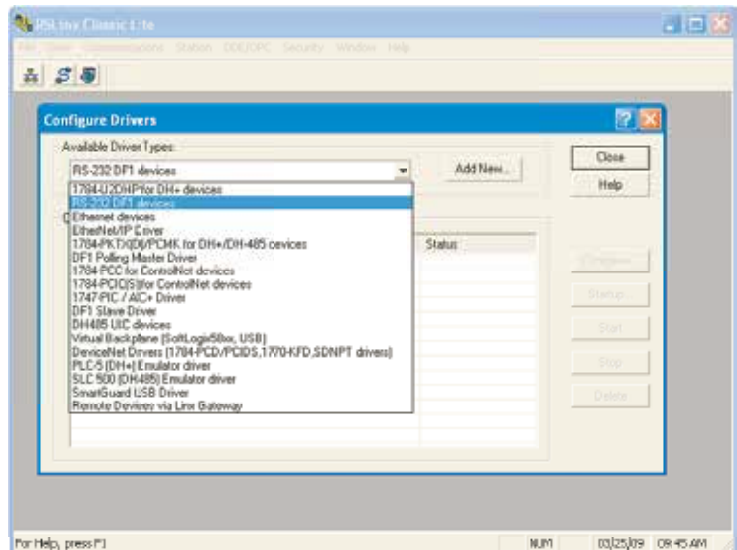

Figure 4.3.21d Configure drivers.

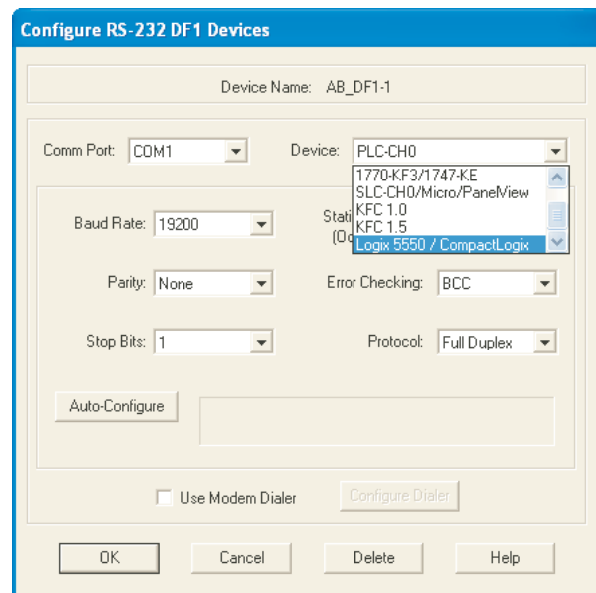

Figure 4.3.21e Configure RS-232 DF1 Devices

4.3.21 ETHERNET/IP OPTION (Cont.)

UPDATING FIRMWARE

CAUTION

Power must be maintained during the Update process (which may take some tens of minutes).
Loss of power during update may render the PLC inoperative.

1. Select the relevant instrument (figure 4.3.21f) and click on 'Update Firmware'. In the 'Choose Firmware Revision' window, select the latest version. Click on 'Update'.
2. Click on 'Yes' or 'OK' as appropriate to accept all the warnings and notes, and wait for the process to complete and to be validated.
3. When the update process is complete, close the 'Who Active' window.

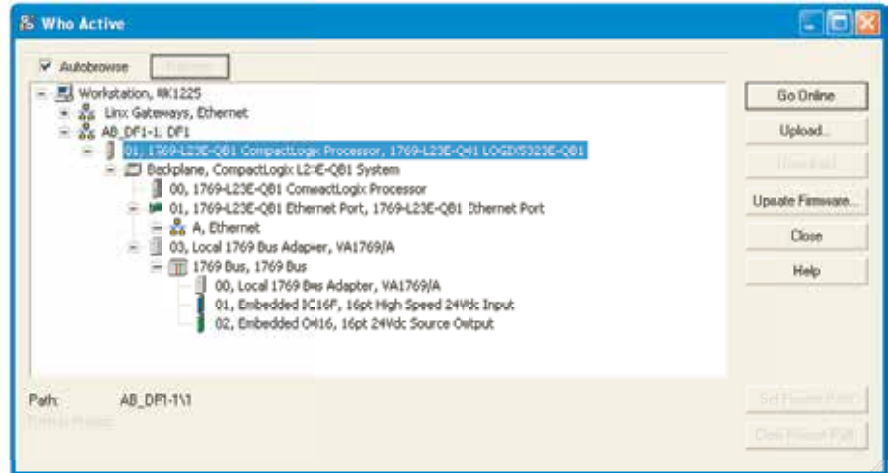



Figure 4.3.21f Who active window

COMPLETING THE LINK

1. In the 'File' menu select 'New', or click on the 'New Tool' icon . The 'New Controller' window opens (figure 4.3.21g).
2. Select the relevant PLC from the drop-down menu. Enter a name, if required and click on 'OK'. After some seconds, the selected controller's window opens.
3. Open the 'Who active' window, and select the relevant instrument from the hierarchy. Click on 'Download'.
4. When the download is complete, right click on the relevant Ethernet port in the left pane 'tree', and select 'Properties' (figure 4.3.21h).

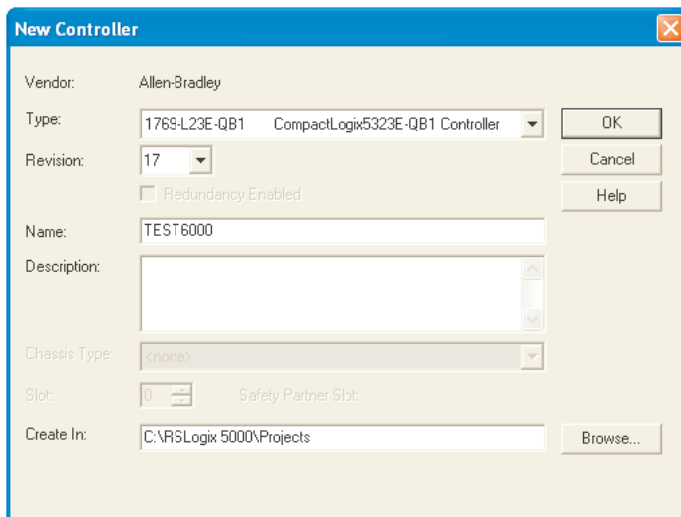

Figure 4.3.21g New Controller window

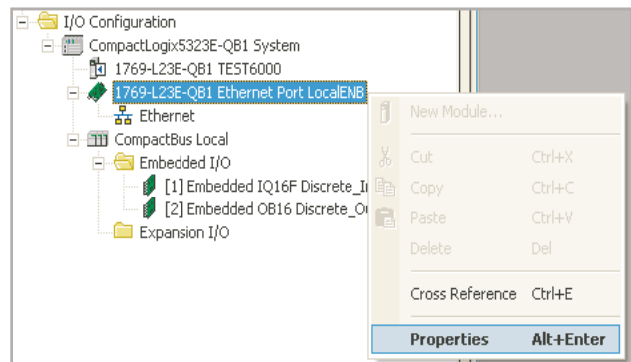

Figure 4.3.21h Ethernet port location

4.3.21 ETHERNET/IP OPTION (Cont.)

5. The Module Properties window opens. Select the 'Port Configuration' tab. For fixed IP Address applications, 'uncheck' the 'Enable BootP' check box, and enter an appropriate IP address and Subnet mask for the PLC.
6. Click on 'Set', and click on 'OK' on the warnings and notes displays.
7. Click on 'OK' to close the Properties window.
8. Left click on the 'Program' icon (figure 4.3.21j) and select 'Go OffLine' from the menu which appears.

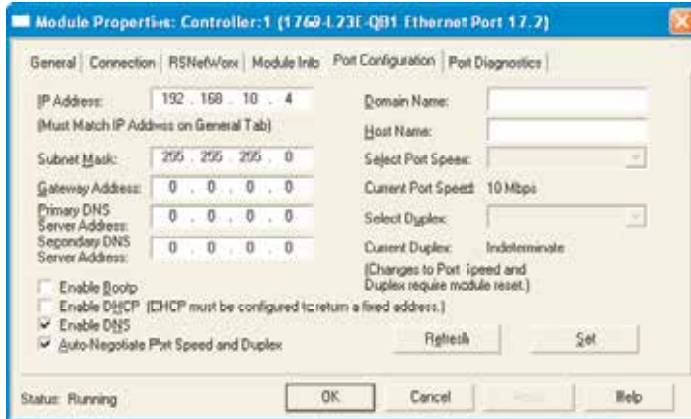

Figure 4.3.21i Module Properties

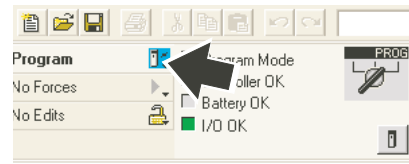

Figure 4.3.21j Click on 'Program' icon

9. Download, either from 'Who Active' or from the Program icon.
10. Connect the PLC to the Ethernet port (RJ45) of the PC.
11. Restore the RSLinx window. In the communications menu Configure Drivers window, select 'Ethernet/IP Driver'. Click on 'Add New' and enter a name for the driver.
12. Select 'Browse local subnet' if this is not already selected.
13. Click on the relevant Network Card and Click on 'OK'.
14. Minimise the RSLinx window.

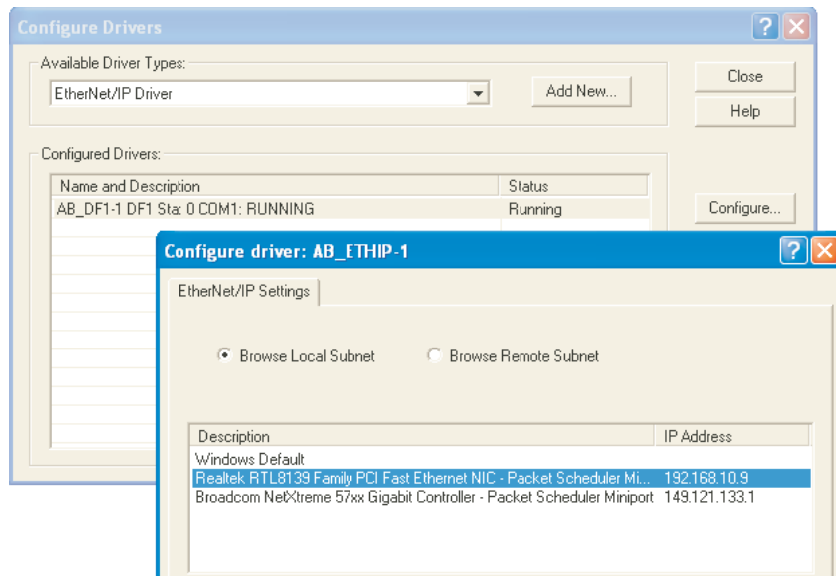

Figure 4.3.21k Configure EtherNet/IP driver

4.3.21 ETHERNET/IP OPTION (Cont.)

CREATING A NETWORK SCANNER

1. In the left pane tree-view of the RSLogix 5000 window, right click on the EtherNet symbol and select 'New Module...' from the menu (figure 4.3.21l).
2. Expand the communications list (click on the + symbol) (figure 4.3.21m)

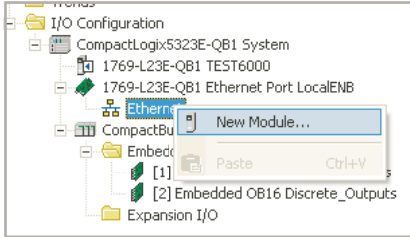

Figure 4.3.21l Right click on the EtherNet symbol

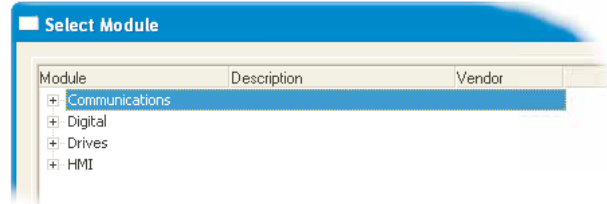

Figure 4.3.21m The communications list (unexpanded)

3. Using the scroll bar as necessary, click on the 'Generic EtherNet Module' item (figure 4.3.21n) and click on 'OK' (or double click on the selected item).
4. In the Parameters page that appears (figure 4.3.21p), enter a name for the module, and set the following values:
 Comm Format: Data - INT
 Address/Host name: The IP address of the recorder (from Operator/Network/Address menu)
 Input: 100; size: 200
 Output: 112; size: 200
 Configuration: 1; size 0
5. Tick (click on) the 'Open Module Properties' checkbox if it is not already ticked.
6. Click on 'OK'

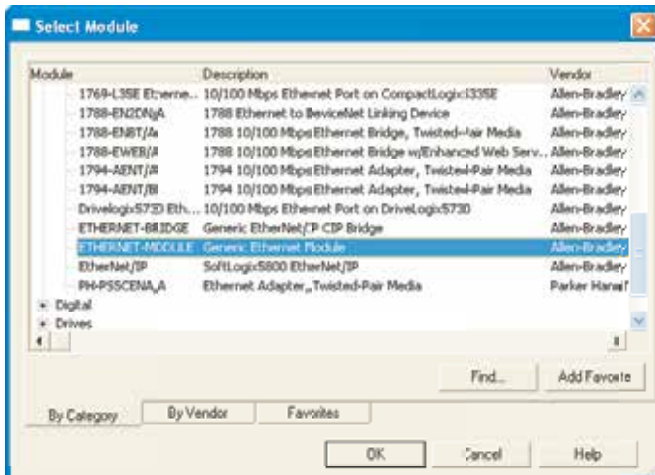

Figure 4.3.21n 'Select Generic EtherNet Module'

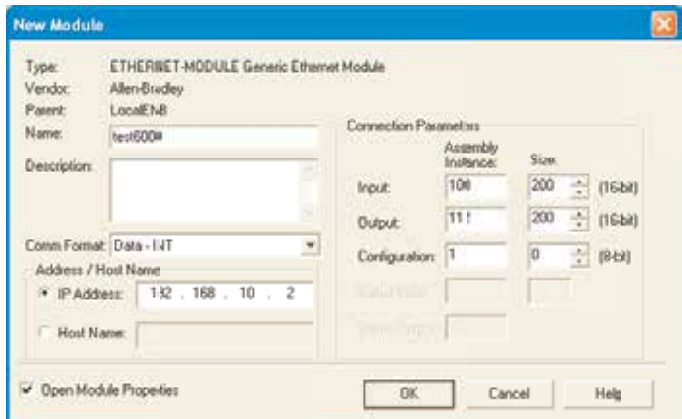

Figure 4.3.21p Enter parameters

4.3.21 ETHERNET/IP OPTION (Cont.)

CREATING A NETWORK SCANNER (Cont.)

- In the Module properties page (Figure 4.3.21q), set RPI to 1000 and click 'OK'.

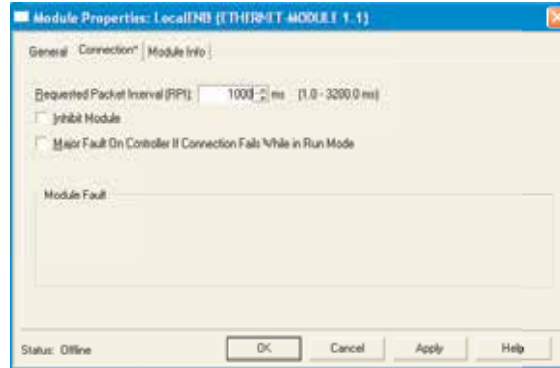

Figure 4.3.21q Module properties page

RECORDER CONFIGURATION

- At the recorder, log in (section 3.3.2).
- In the Operator/Config menu, touch the 'Options' item (at the bottom of the list). Check that 'EtherNet/IP' is enabled. If not, the software needs to be upgraded as described in section 4.6.3 and an 'Autoconfigure' carried out.
- In the Operator/Config/Channels area (section 4.3.3), configure the channels as appropriate. Those channels which are to receive data from the PLC should have their 'Input Type' set to 'EtherNet/IP Comms Input'. The System/Copy facility (section 4.6.8) can be used to speed up the process. Maths channels are set up in a similar way (section 4.3.11).
- Set scale, units etc. to appropriate values.

Note... For the EtherNet/IP application, the number of decimal places is set to zero by default. Editing this value may lead to loss of resolution in the values displayed.

- Configure the EtherNet/IP input table as required (described earlier in this section).
- Ensure that the PLC is connected to the recorder either directly using a cross-over EtherNet cable or via a switch using non cross-over cable.

RUN MODE

- Set the PLC into either 'Remote' or 'Run' mode.
- Set the PLC online

STATUS INDICATORS

The status indicators at the top left corner of the RSLogix 5000 Page (Figure 4.3.21s) show the status of the link between the pc and the PLC.



Figure 4.3.21s Status displays

It is possible to check that the PLC is communicating with the recorder using the 'Tags' display to write values to the recorder and to receive values from it. Once it is proved that the link is working, the pc may be disconnected from the PLC if required.

4.3.22 Options

The screenshot displays a list of configuration options for a recorder, each with a dropdown menu. The options are as follows:

Trial Mode	Disabled
Trial Time Remaining	30 day(s)
Fitted channels	18
Virtual channels	36
Maths	12
Totalisers	12
Counters	7
Groups	12
Batch	Enabled
Security Manager	Disabled
Auditor	21CFR11
Screen Builder	Full
Bridge Level	Full
Master Comms Devices	32
Simulation	Disabled
AeroDAQ	Disabled
EtherNet/IP	Enabled
TUS	Enabled
Relay Boards	2 (currently 1)
Relays on Board 1	3
Relays on Board 2	4 (currently 0)
Event Input Boards	1
Analogue Output Boards	1 (currently 0)

At the bottom of the menu are three buttons: **Apply**, **Discard**, and **Autoconfigure**.

Figure 4.3.22 Options menu layout

Touching this key calls a display showing the current recorder hardware/software setup, for example the number of input channels fitted, the number of output relay boards fitted, and how many relays are fitted per card. Subsequently, should further options be fitted (relay board two and Analogue output board 1 in the above example), this page shows the difference between the hardware actually fitted and the hardware the recorder software is configured for (currently ...). Whenever there is a difference, the 'Autoconfigure' key can be pressed to alert the recorder to the fact that extra options have been added (or taken away).

If no changes have occurred since last switch-on, then the '(currently ...)' fields and the 'Autoconfigure' key do not appear.

4.3.22 OPTIONS (Cont.)

TRIAL MODE

Enabling 'Trial Mode' allows the user to enable, temporarily, the various software options that are available. Once the user has made the required choices, the 'Set Trial Options' key at the bottom of the screen, must be operated, followed by an 'Autoconfigure' procedure.

Initially, the trial mode is set to expire 30 days after enabling (whether the recorder is powered or not). Any change in configuration results in a pop-up message stating how much of the 30 days period remains. Once Trial mode is disabled by the user, the remaining 'Trial Time Remaining' value is retained until Trial Mode is re-enabled.

Notes:

1. Trial mode enables/disables all options or features (except 'Simulation' and 'History Maintenance') which are not fitted or enabled in the recorder. The number and distribution of virtual channels reverts to that configured before Trial mode was invoked.
 2. When disabling Trial mode, all configuration for the trial features is lost. Should the user decide to purchase a trial feature, then it is recommended that the trial configuration be saved (see section 4.2) so that it may be restored once the purchased trial feature is fitted and enabled (keycodes cannot be entered in Trial Mode).
 3. Trial mode can be enabled only by users with 'Perform upgrades' permission (section 4.4.1).
-

VIRTUAL CHANNELS

Virtual channels are Maths channels, Totalisers and Counters. The total number of virtual channels is as specified at time of order. A maximum of 128 virtual channels is possible (as a chargeable option). The user can select whatever combination of maths channels, totalisers and counters is required, so long as the total does not exceed the number of virtual channels available. If it does, a warning is given when the 'Apply' button is operated, and the edit is ignored.

Note: If more than 100 maths channels are required, it is possible to use some of the totaliser channels modbus address space, however the Modbus register addresses of totalisers and counters are affected, to make room for the additional channels.

If for example there were 105 maths channels, the value of the new maths channel 101 would be at the address normally associated with totaliser 1, in turn totaliser 1 would be found in totaliser 6, and the value of counter 1 would be found at the address normally associated with counter 6. The 5 new channels being added will increment the existing allocated values along by the same amount of channels being added - to a maximum of 28.

4.3.22 OPTIONS (Cont.)

SIMULATION OPTION

This option consists of a number of additional jobs, as described below. This option is not enabled in 'Trial mode'.

TREND FREEZE

When this 'Trend' category job ([section 4.7.11](#)) is initiated, the displays are held at their values at the time of initiation. When the recorder is 'unfrozen' the displays switch to their current values, and the clock re-starts from where it stopped. No blue line is drawn across the trace to indicate time discontinuity (Time change records - [section 3.4](#)).

Note: If 'SNTP client enable' is enabled (Network Address area - [section 4.5](#)), then the recorder time is synchronised at power-up only. I.E. the normal checks of recorder time compared with server time are not carried out with the Simulator option enabled.

If 'SNTP server enable' is enabled, then the recorder will supply recorder time.

CLEAR

This 'Trend' category job ([section 4.7.11](#)) clears the display. Used in conjunction with 'Erase all History' (below), this is known, in some applications, as Recall Mode.

ERASE ALL HISTORY

This 'Recording' category job ([section 4.7.10](#)) erases all the history files in the recorder. Used in conjunction with 'Clear' (above), this is known, in some applications, as Recall Mode.

Note: If the 21CFR11 option is enabled, Erase All History jobs can be triggered, but are ignored, leaving the recording history unaffected.

SCREEN SAVER

This 'Trend' category job ([section 4.7.11](#)) switches the display brightness to the value set up in 'Saver Display' (Instrument Configuration - [section 4.3.1](#)) for the duration of the job. The job overrides the 'Save after' time value also set up in Instrument Configuration.

4.4 SECURITY

Touching this key allows the operator to select 'Login' (described in section 3.3.2), 'Access', 'Management' or 'Add/Remove User' for configuration. Selecting 'Access' displays the current user level. Touching this area allows the user to select 'Logged out', 'Operator', 'Engineer' or any of the added users. The user may also go directly to logged out mode by operating the 'Logout' key.

For users with Security Manager option enabled, 'Change Password' and 'Clear Password Cache' may also appear in this menu depending on the user's access level.

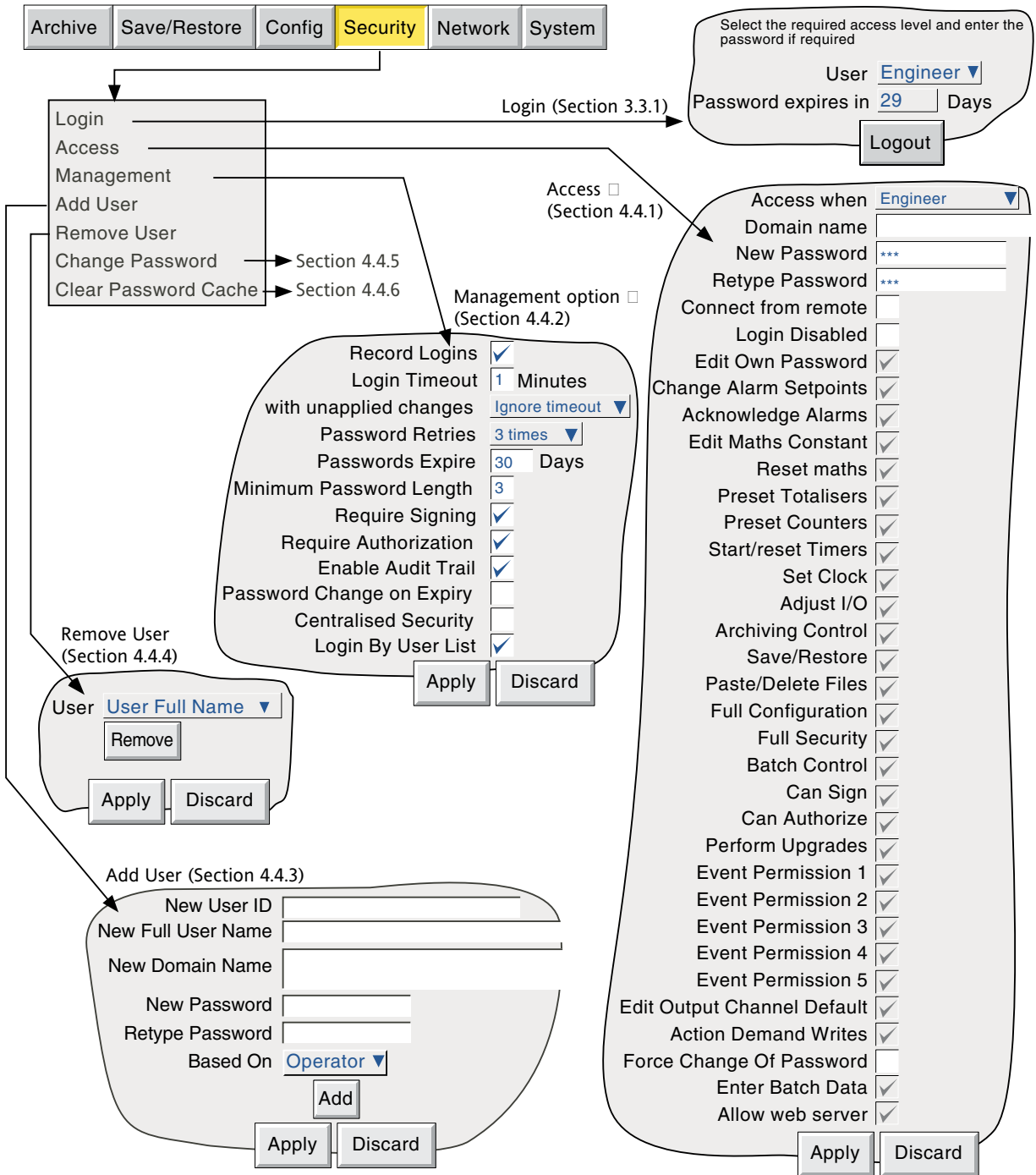

Figure 4.4 Security configuration menus

4.4.1 Access levels

The access levels available with the recorder viz are; Logged out, Engineer and Operator. When logged-in at Engineer level, the user can set access permissions for other levels and can enter or edit passwords for Operator and Engineer levels.

Note: The Service access level, though on display is no longer selectable or functional from version 5.8.4.

The default password for 'Operator' level access is 'blank' (i.e. no password is required), however the Operator access level can only be enabled by the Engineer access level, after logging in using the Engineer password configured at 3.3.1 Initial Setup.

Note: To minimise free access to the recorder configuration, the Engineer access level must have a password configured at first switch-on. Then the Engineer using their access can set access permissions for other levels.

Users with Full Security permission can Add (and Delete) users (sections 4.4.3, 4.4.4) and assign them individual passwords and access permissions.

SETTING PERMISSIONS

Once logged in at Engineer level, operate the Security key and select Access. A page similar to that shown in figure 4.4.1 appears, allowing the permissions to be set for the various access levels and for individual users. The list of parameters is the same for all access levels except for 'Logged out', for which the password parameters and 'login disabled' items do not appear.

Note: If the Security management option is fitted, and 'Centralised Security' is enabled in the Security/Management system (section 4.4.2), permissions are 'Read Only' (i.e., not editable) at the recorder. In such a case permissions can be changed only by using the Security Management software.

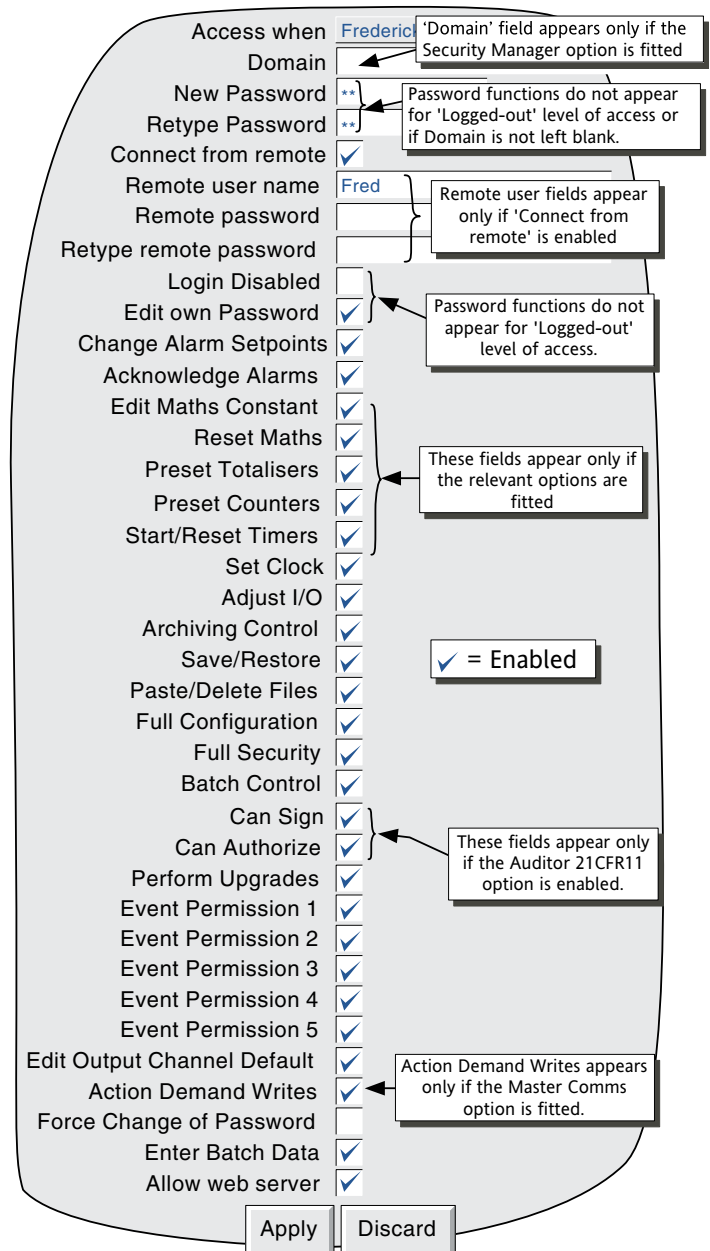

Figure 4.4.1 Access permissions menu

4.4.1 ACCESS LEVELS (Cont.)

ACCESS WHEN

Allows an access level or an individual Full User Name to be selected from a pick list.

DOMAIN NAME

For units fitted with Security Manager option only, this allows a security domain name of up to 60 characters to be entered, for the user selected in the 'Access when' field. If the default (blank) is not edited, then the user can gain access using password setup in the 'New password' field described below. If a new domain name is entered here, or if one already appears, the 'New Password' and 'Retype Password' fields are not displayed, and the user must use his or her network login password, as allocated by the user's IT department or Network administrator.

Details of the Active Directory Server are entered in Network/Address configuration ([section 4.5.1](#)). Passwords can be edited as described in 'Change Password' ([section 4.4.5](#))

If 'Centralised security' is enabled in the Security/Management menu ([section 4.4.2](#)) then the Domain name can be configured only using Security Manager software.

Note: An IP address must not be used as the domain name because to do so will disable the user's ability to log in using Active Directory, even if there is a valid account on the server.

NEW PASSWORD/RETYPE PASSWORD

These fields do not appear if 'Access when' = 'Logged Out', or if the 'Domain Name' is anything other than left blank.

These fields allow a new password to be entered for the selected access level or User. The password must also be entered in the 'Re-type Password' field. If the two differ, a warning message (Passwords did not match) appears when the APPLY key is operated, and password entry must be repeated. If the password does not comply with the minimum length requirements in Security Management (if fitted) ([section 4.4.2](#)), a warning message (Invalid Password) appears when the 'Apply' key is operated, and password entry must be repeated.

CONNECT FROM REMOTE

Enabling this field, causes two further entry boxes: 'Remote user name' and 'Remote password' to appear. These items are used in establishing connection between a host computer and the recorder. The Remote user name is, by default, the Access Level (e.g. 'Engineer') or the User ID.

To make use of the Web server facility ([Annex C](#)), 'Allow web server' (below) must also be enabled.

REMOTE USER NAME/REMOTE PASSWORD

These two entry boxes allow user name and password to be entered for use by the remote host operator. The remote user will be able to access the recorder configuration according to the other access permissions enabled in this page. The password must be entered twice to ensure integrity.

To allow unrestricted view-only to the host, 'Logged out' permission level should be selected and then a user name of 'anonymous' entered, and the password field left blank.

Notes:

1. Remote login will be refused if the user account is disabled for any reason.
 2. For maximum security, it is recommended that the remote password and the 'local' password are non-identical.
 3. Attempts to establish a [Bridge connection](#) will fail if the relevant Remote User Name contains characters with ASCII codes greater than 127 (such as é, è, a., ü etc.). [Section B6](#) (Annex B) shows codes 0 to 127.
-

4.4.1 ACCESS LEVELS (Cont.)

LOGIN DISABLED

WARNING

This feature should be used with discretion, or the situation might arise in which the recorder cannot be logged onto, either at a particular access level or at all. It is recommended that at least one user with Engineer-level access is retained with login enabled, or it may become necessary to return the recorder to the manufacturer, or to arrange for a service visit.

For all levels except Logged Out, This allows any one or more of the access levels to be removed from the 'Access when' picklist.

Auditor option notes:

1. If the Auditor 21CFR11 option is fitted, and the number of Password Retries is exceeded then the relevant login is disabled. A user with Engineer level access can re-enable the login.
 2. If the Auditor 21CFR11 option is fitted, and the Password Expire time has been exceeded, all logins are disabled.
Access will not be possible, and the recorder will require configuration. Please contact your local Eurotherm support desk in the unlikely event of being locked out for further advice.
-

EDIT OWN PASSWORD

Allows each user, with this permission enabled, to edit his/her password.

CHANGE ALARM SETPOINTS

Allows each user with this permission enabled, to edit alarm parameters under Configuration/Channel

ACKNOWLEDGE ALARMS

Allows each user with this permission enabled to acknowledge alarms ([section 3.1.4](#))

EDIT MATHS CONSTANT

For recorders fitted with the Maths option only. If one or more maths channels are configured with function 'Constant', then with this permission set, the user may edit the constant value(s).

RESET MATHS

Allows the user to reset applicable maths functions. See [section 4.3.11](#) for further details of maths functions.

PRESET TOTALISERS

Allows the user to preset totaliser values (if the option is fitted). See [section 4.3.12](#) for further details of totalisers.

PRESET COUNTERS

Allows the user to preset counter values (if the option is fitted). See [section 4.3.13](#) for further details of Counters.

START/RESET TIMERS

Allows the user to start and reset the timer value. See [section 4.3.14](#) for further details of timers.

SET CLOCK

Allows each user with this permission enabled, to set the recorder time and date functions under [System/Clock](#)

ADJUST I/O

Allows the user to adjust recorder inputs and outputs as described in [section 4.6.4](#), and [section 9](#) below.

4.4.1 ACCESS LEVELS (Cont.)

ARCHIVING CONTROL

Allows each user with this permission enabled full access to archive control. For units fitted with the [lockable flap](#) option, the flap may be unlocked only by users who have this Archiving Control permission enabled.

SAVE/RESTORE

Allows each user with this permission enabled, full access to saving and restoring functions as described in [section 4.2](#), above. Without this permission, the SAVE/RESTORE key does not appear.

PASTE/DELETE FILES

Allows each user with this permission enabled, to Paste and Delete files as described in [section 5](#).

FULL CONFIGURATION

Allows each user with this permission enabled, full access the recorder configuration.

FULL SECURITY

Allows each user with this permission enabled, full access to all recorder security functions.

BATCH CONTROL

This field appears only if the Batch Option ([section 4.3.10](#)) is fitted. Allows the user to enter batch data and to start, stop and create new batches. If this access permission is set, 'Enter Batch Data' below, is automatically enabled and cannot be disabled.

CAN SIGN

This appears only if the Auditor 21CFR11 option is fitted. If the field is enabled it allows the user to change the configuration of the recorder (according to the other permissions set for the login), providing the security management system 'Require Authorization' is not enabled. If it is, changes can be made only if the correct password for a user with 'Can Authorize' permission is entered. See [section 4.4.2](#) for details

CAN AUTHORIZE

This appears only if the Auditor 21CFR11 option is fitted. If the field is enabled it allows the user to change the configuration of the recorder according to the permissions set for the login. See [section 4.4.2](#) for details of the Auditor options.

PERFORM UPGRADES

'Upgrade' appears in the system menu only for access levels in which this box is ticked. [Section 4.6.3](#) contains further details. Trial mode ([section 4.3.22](#)) can be enabled/disabled only by users with Perform Upgrades permission.

EVENT PERMISSION 1

If this is enabled, then this login will trigger an event source which remains active for as long as the login is active. See [section 4.3.6 \(Event Sources: User Logged In\)](#) for further details.

EVENT PERMISSION 2 TO 5

As for Event permission 1, above.

EDIT OUTPUT CHANNEL DEFAULT

Appears only if the Master Comms and/or Analogue output option is fitted. When enabled, this allows a user with this login to edit the default value of any output channel. Normally the defaults are used only when the source channel is 'In Error'.

4.4.1 ACCESS LEVELS (Cont.)

ACTION DEMAND WRITES

Appears only if the Master Comms option is fitted. See [section 4.3.16](#) and [section 4.3.18](#) for further details.

When enabled, this allows a user with this login to write values manually over master comms either directly, by job action or (if the option is fitted), by using the User Screens 'Operator' key. Where Demand Writes are initiated by Job action, the job will be carried out whether or not this login has permission to action Demand Writes.

Note:

When Audit trail is enabled, only the newly written value appears in the audit trail messages. This is because the instrument has no way of determining what the value of the parameter was before the write occurred.

The messages are of the form:

```
23/08/05 10:14:30 Auto Mode wrote 19.37
```

```
23/08/05 10:14:29 Demand write Auto Mode, Signed Engineer, No Auth. Req'd., Note where 'Auto Mode' is the descriptor associated with the demand write, and '19.37' is the value written.
```

FORCE CHANGE OF PASSWORD

When this checkbox is enabled for a user, it means that the user will have to change password at his/her next login. At next log in, a pop-up dialogue box requests that a new password be entered. If a new password is not entered, login is denied.

Entering the new password clears the checkbox, so this is a 'one-shot' operation, until the checkbox is enabled again by a user with 'Engineer' level access.

ENTER BATCH DATA

If 'Batch Control' is enabled, then this field is automatically enabled, and is 'greyed out' so that it cannot be edited.

If 'Batch Control' is not enabled, then enabling this item allows the user to enter batch data, but not to start, stop or create new batches.

ALLOW WEB SERVER

Any user with this permission and 'Connect from remote' permission will be able to view the recorder from a remote PC, using the [Remote user name and Remote password](#) described above.

Note: See [Annex C](#) for details of the Web server facility.

4.4.2 Management (option)

Note: Where users are controlled by a domain on the recorder, Security Manager will not manage or reconcile disabled accounts, password changes or password expiry on these recorders.

This menu selection appears only if the Audit Trail option, 21CFR11 option and/or Security Management option is fitted. Which configuration fields appear depends on the option(s) fitted. Figure 4.4.2a, below, shows the configuration menus for the various combinations.

The 21CFR11 option allows the recorder to be set up so that all changes to configuration (with the exceptions listed below) are added to the history files and also allows certain constraints to be placed on the recorder passwords. Once these items of configuration are set up, they apply to all groups. Figure 4.4.2a, below, shows the configuration menu.

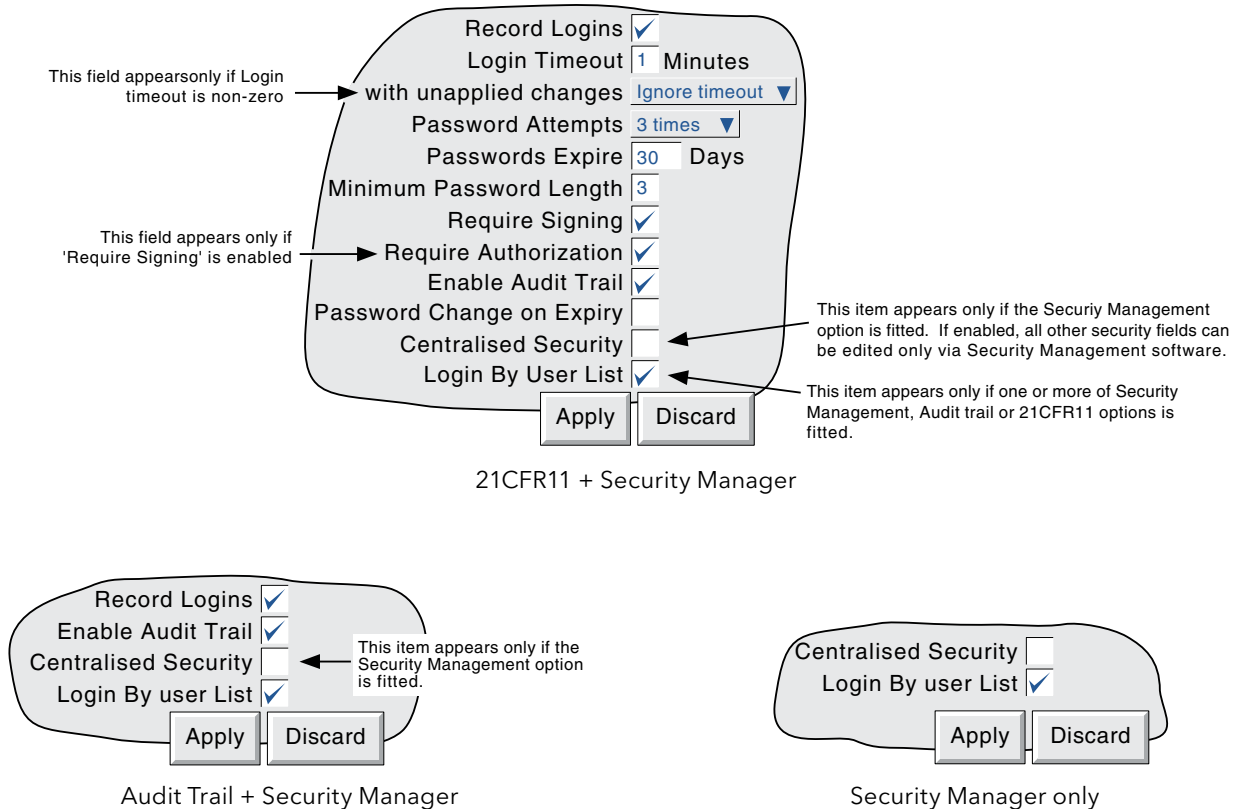

Figure 4.4.2a Management menu structure

CHANGES NOT RECORDED

Changes to configuration made via MODBUS/TCP are not recorded. It is up to the user to write the identity, time/date, reason for change etc. as text messages, which when sent via MODBUS/TCP, become part of the relevant history file.

CONFIGURABLE PARAMETERS

Notes:

1. Unless otherwise indicated, the following parameters appear only if the Auditor 21CFR11 option is fitted.
2. If Centralised Security is enabled, none of the other parameters in this menu can be edited at the recorder. Changes can be made only using Security Management software.

4.4.2 MANAGEMENT (Cont.)

- Record logins** For either Auditor option, if this field is enabled, then each time a new login occurs a message appears, giving the date, time and login name. E.G.
23/08/08 15:32:20 Login by Frederick Bloggs
Logouts are recorded in a similar way - e.g.
23/08/08 15:49:43 Logout by Frederick Bloggs
If the login or logout is via a 'Bridge' session (section 6), the IP address of that viewer appears in the login/logout message - e.g.
23/08/05 15:58:03 Login by (149.121.130.126)Engineer
- Login Timeout** When set to zero, the login remains valid until changed. For any other value, the user is logged out after the number of minutes entered here has elapsed since the last time the screen was touched.
- with unapplied changes** This field does not appear if the Login Timeout has been set to zero. For non-zero time-out values, this allows the user to choose whether
a any unapplied changes are lost when the Login Timeout period has elapsed, or
b the login timeout is ignored if there are any unapplied configuration changes.
- Password Attempts** For Active Directory users, this parameter is configured at the Active Directory and the value set at the instrument is ignored.
For other users, this allows the user to limit to three, the number of attempt that can be made to enter a password. The choices are '3 times' and 'unlimited'. When set to 3 times, the user login is disabled after three incorrect attempts to enter the password have been made. A 'System Message' appears on the screen and is also sent to the 'chart':
23/08/08 13:20:42 User Frederick Bloggs, login disabled, invalid password
In order to re-enable the login, a user with Engineer access level must deselect 'Login Disabled' in the 'Access' menu described in [section 4.4.1](#), above.
- Passwords expire** For Active Directory users, this parameter is configured at the Active Directory and the value set at the instrument is ignored.
For other users, this field allows the user to set an expiry period of up to 999 days which applies to all passwords. The number of days remaining to expiry is shown in the login page. If set to zero, then the expiry period does not apply.

WARNING

All required passwords **MUST** be changed within this number of days or all logins will be disabled. Access will not be possible, and the recorder will require configuration. Please contact your local Eurotherm support desk in the unlikely event of being locked out, for further advice. (See 'Password Change on Expiry' below, for further information).

- Minimum Password Length** For Active Directory users, this parameter is configured at the Active Directory and the value set at the instrument is ignored.
For other users, this allows a minimum length of password to be entered (default = 0; minimum = 3). If an attempt is made to enter a new password with fewer characters than the minimum, a warning message appears on the screen (Invalid Password Length) and the new password is ignored. For Active Directory users, the password must comply with both the minimum length specified here and that specified in Active Directory.
- Require Signing** If this field is enabled, then changes to the recorder operation, configuration (or any other item included in the history file) can be made only by those users whose 'Can Sign' permission is enabled in the 'Access' menu described in [section 4.4.1](#) above. When 'Apply' is attempted, a 'signature' page appears which requires the entry of the correct password for the selected user, and of a note which would normally be used to give the reason for the change.

4.4.2 MANAGEMENT (Cont.)

CONFIGURABLE PARAMETERS (Cont.)

Require Authorization

This field appears only if 'Require Signing' is enabled. If Require Authorization is enabled, then changes to the recorder operation, configuration (or any other item included in the history file) can be made only by those users whose 'Can Authorize' permission is enabled in the 'Access' menu described in [section 4.4.1](#) above. When 'Apply' is attempted, a 'signature' page (figure 4.4.2b) appears which requires the entry of the correct password for the selected user, and a note which would normally be used to give the reason for the change.

Note: If neither 'Require Signing' nor 'Require Authorization' is enabled, then any user can make changes to the recorder operation, configuration etc. and the 'signature' page does not appear.

Figure 4.4.2b Signature page

Enable Audit trail For either Auditor option, if this field is enabled, then all changes to configuration are displayed on the 'chart' and become part of the history file for each enabled group. The following is an example of how these changes would appear on the screen for an imaginary set up for channel 8. 'New T/C type chan 8' is the note entered in the Signature page, and 'Kiln8 temp' is the channel descriptor.

```
03/08/05 11:53:01 Configuration Revision 486,144 was 486,143
03/08/05 11:52:57 Kiln8 temp Alarm Number 1, Job Number 1 Drive Relay 1 on board 7
while Unacknowledged was No action
03/08/05 11:52:57 Kiln8 temp Alarm Number 1 Threshold 530.0 °C was 500
03/08/05 11:52:57 Kiln8 temp Alarm Number 1 Type Absolute Low was Absolute High
03/08/05 11:52:57 Kiln8 temp Cold Junction Type Internal was External
03/08/05 11:52:57 Kiln8 temp Scale High 1000.0°C was 900.0
03/08/05 11:52:57 Kiln8 temp Scale Low 450.0°C was 300.0
03/08/05 11:52:57 Kiln8 temp Lin Type Type K was Type J
03/08/05 11:52:57 Config,Signed:Engineer,Authorized:Engineer,New T/C type chan 8
```

(Please see notes below)

4.4.2 MANAGEMENT (Cont.)

CONFIGURABLE PARAMETERS (Cont.)

Notes:

1. The Configuration Revision (and for changes in the Security menus - the Security Revision) are incremented every time the recorder configuration (security configuration) is changed. The current values can be viewed in the System/About menu (section 4.6.11).
2. All configuration and security changes must be made either at the recorder operator interface, or from a host pc using Bridge 'Full' software. Use of the configuration editor is not permitted if traceability is to be maintained.
3. If fitted, Event buttons (section 4.3.7) are not included in the Require Signing/Require Authorization regime described above. Instead, each individual button can be configured to require signing or to require both signing and authorization.
4. If a large number of configuration changes are made with Audit trail enabled, then the number of messages produced may result in the total amount of data generated exceeding the amount that can be written to the internal FLASH memory in the time available, particularly if there are a large number of points configured. The recorder responds by reducing the recording speed, and a message 'Recording failed - internal overflow. Slowing recording interval of fastest group(s)' appears, to draw the user's attention to the situation.
5. If the TUS option is enabled, then enabling Audit trail can causes pre calibration and post calibration values to be printed for each adjusted channel, before a batch initiation and/or after a batch stop according to the configuration of the 'Pre calibration' and 'Post calibration' tick boxes in the Batch Configuration menu.

Password Change on Expiry

If this check box is enabled, then the first time a user tries to login, after his or her password has expired, a dialogue box appears asking the user to enter a new password. Only when this new password has been entered and confirmed, will the user be able to access the recorder configuration.

Security Management Option. The new password is not written to the Security Manager until the next 'deploy', after which the expiry period configured for the user (within Security Management), is restored. The interim expiry period is set to 24 hours, and the 'deploy' must be carried out within this period, or password expiry will recur.

Centralised Security This checkbox occurs only if the Security Management option is fitted. If this checkbox is enabled, none of the other parameters in the Management menu can be edited at the recorder (i.e. they become 'Read Only'). Changes can be made only by means of Security Management software. At the recorder, the menu items below also become 'read only', or do not appear as menu items or are not selectable, even if the checkbox appears:

Access level permissions (section 4.1.1) (Read Only)

Add User/ Remove User (section 4.4.3/4) (Do not appear as menu items)

Restore configuration/Security data (section 4.2.2) (Not selectable)

New configuration/Security data (section 4.2.3) (Not selectable)

(Continued...)

4.4.2 MANAGEMENT (Cont.)

CONFIGURABLE PARAMETERS (Cont.)

Centralised security (cont.)

The Security Revision (previously Security Version) is initially set to -1 when Centralised Security is enabled. It will remain at this value until a successful download has been performed via Security Manager Software. The Security Revision will then take the downloaded value (e.g. 139). Any local security revision changes (e.g. max. number of logins exceeded) cause the value to have a 'local change count', starting at 001 appended to it (e.g. 139.001, 139.002 and so on). The local change count is reset to 000 (and no longer displayed) when the next download occurs (e.g. 140). Downloads can occur automatically when the Security Manager detects that a local change has occurred, or manually, as and when required.

If Centralised Security is enabled, the Domain name can be edited only using the Security Manager software.

Login by User List This checkbox appears if either of the Auditor options and/or the Security management option is fitted. When enabled, the normal login window appears, with a pull down list of users. Once a user has been selected the correct password for that user must be entered in order to log in. When disabled, the user must enter a user name and associated password in order to log in.

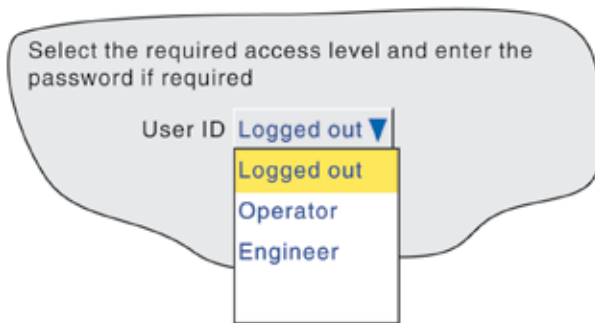

'Login by user list' enabled

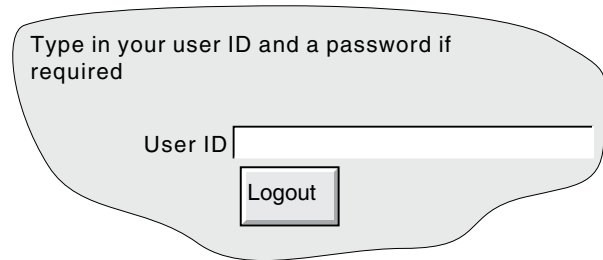

'Login by user list' not enabled

4.4.3 Add user

Figure 4.4.3 shows that the selecting of 'Add User' from the SECURITY picklist allows new user IDs to be entered, together with passwords, and a chosen set of access permissions, which can subsequently be edited under Security/Access. The ADD key and the APPLY key must both be used to write the change to the recorder data base. The user must have Full Security access in order to add a new user. If either Auditor option is fitted, the new user's access permission list is printed on the chart.

Adding a new user clears the recorder's password cache, as described in [section 4.4.6](#), below.

Figure 4.4.3 Add User display page

NEW USER ID

This field allows a User ID of up to 20 characters to be entered for a new user. This ID is used when logging in using ID/password entry technique (that is, when 'Login by user list' is disabled, as described in [section 4.4.2](#) above).

NEW FULL USER NAME

This field allows a User name of up to 25 characters to be entered. This name appears in the 'current access level' pushbutton at the top left corner of the display screen, in operator notes and so on.

NEW DOMAIN NAME

For units fitted with Security Manager only, this allows the entry of a Security Domain name (up to 60 characters in length). If such an entry is made, the Password fields described below do not appear, and the user must use a network login assigned by the IT department or by the network administrator. The domain name appears in the 'Access' menu and can be edited there if required, once the 'Add User' procedure is complete.

If 'Centralised Security' ([section 4.4.2](#)) is enabled this Domain name can be edited only using Security Manager software.

Note: An IP address must not be used as the domain name because to do so will disable the user's ability to log in using Active Directory, even if there is a valid account on the server.

NEW PASSWORD/RETYPE PASSWORD

For units fitted with the Security Manager option, if the New Domain Name (above) is anything other than the default (left blank), these Password fields do not appear, as any user with a domain configured must use the password allocated by the Network administrator.

For other users, these fields allow a password to be entered and confirmed. If the password does not comply with the minimum length requirements in Security Management (if fitted) ([section 4.4.2](#)), a warning message (Invalid Password) appears when the 'Apply' key is operated, and password entry must be repeated.

BASED ON

This picklist allows another user or access level to be used as a permissions template, to simplify the configuration if several operators are to have identical permissions.

4.4.4 Remove user

Selecting 'Remove User' from the SECURITY picklist allows users to be removed from the user list. The 'Remove' key and the 'Apply' key must both be used to write the change to the recorder data base. Figure 4.4.4 depicts the display page. The User Full Name appears in this page.

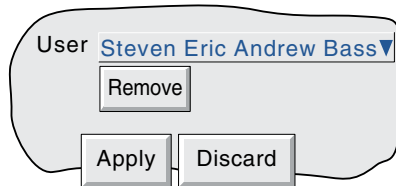

Figure 4.4.4 Remove User display page

For Active Directory users:

1. Removing a user clears the recorder's password cache, as described in [section 4.4.6](#), below.
2. Removing a user from the Active Directory Domain does not automatically remove that user from the recorder. A 'Remove user' procedure must also be carried out.

4.4.5 Change Password

For units fitted with the Security Manager option, this allows the entry of a new password for the currently logged-in user, providing that the user has 'Edit own password' enabled in the 'Access when' list and is Active Directory authenticated.

Notes:

1. This feature should be used with discretion, as it affects Network logins which would normally be under the control of the user's IT department or Network Administrator. Changing the password may cause conflicts within the network thus preventing its efficient operation.
2. If 'Active Directory security' is set to 'None' ([section 4.5.1: Network/Address menu](#)), any attempted changes to the password will be rejected. That is, only passwords on a Transport Layer Security (TLS) secured connection are accepted.
3. The old password remains valid for up to an hour (default) after the change, and during this period, both passwords are valid. The default period can be edited by the Network administrator.

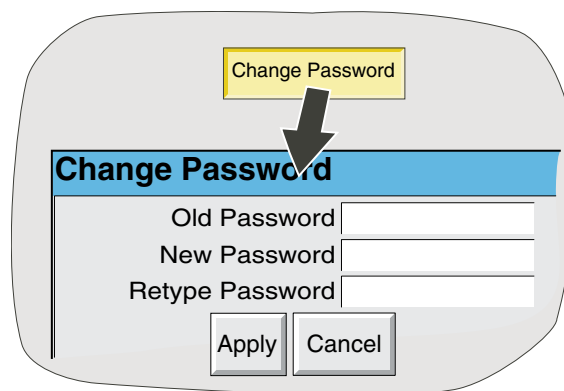

Figure 4.4.5 Change password

TROUBLE SHOOTING

If the change password procedure fails:

1. Check that the Active Directory server instrument alarm is inactive ([section 3.1.3](#))
2. Check that the connection with the Active Directory server has TLS security enabled ([section 4.5.1](#))
3. Check that the new password's length, complexity, history and minimum password age match the criteria laid down in the Active Directory password policy configuration. Password length must also comply with the minimum password length configured in the security menu ([section 4.4.2](#))

4.4.6 Clear Password Cache

This menu item appears only for units fitted with the Security Manager option and only for users with 'Full Security' access ([section 4.4.1](#)).

USER PASSWORD AUTHENTICATION

If the user has a domain configured, then when an attempt is made to log in, the password entered by the user is authenticated by the Active Directory server (see Network/Address menu description). In other words, the recorder attempts to do an LDAP* bind with the configured Active Directory server, and if the 'bind' is successful, the user is logged in.

* Lightweight Directory Access Protocol

PASSWORD CACHE

Once a password has been authenticated, it is added to a list of up to 100 valid passwords (the Password cache) held in the recorder. This means that if the Active Directory server is unavailable the next time the user attempts to log in, then if the password is in the cache, the login will proceed without further authentication.

CLEAR PASSWORD CACHE

If necessary the password cache can be cleared by using the Clear Password Cache button (confirmation required). The cache is also cleared:

1. whenever a new user is added to the user list ([section 4.4.3](#)),
2. the login for an existing user is removed ([section 4.4.4](#)).
3. if the 'Password Cache expiry' value has been exceeded ([section 4.5.1](#)).

4.4.7 Active Directory server setup

For users with Security Manager option only.

It is assumed that the person responsible for operating the Active Directory server is familiar with the basics of setting up a suitable server. The details given below explain the file structure necessary in order that the Security Manager software may communicate with the server. Briefly, a 'User' must be a member of a 'Group', which must be part of an 'Organizational unit' (figure 4.4.7a).

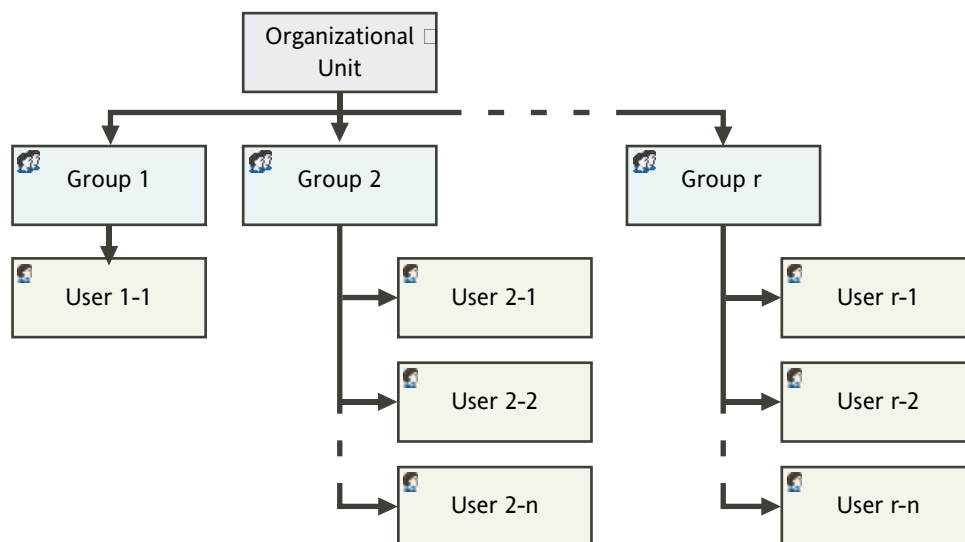

Figure 4.4.7a Structure overview

4.4.7 ACTIVE DIRECTORY SERVER SETUP (Cont.)

1. In the 'Domain Controller (Active Directory)' area of the 'Manage your Server' screen, click on 'Manage users and computers in Active Directory'.

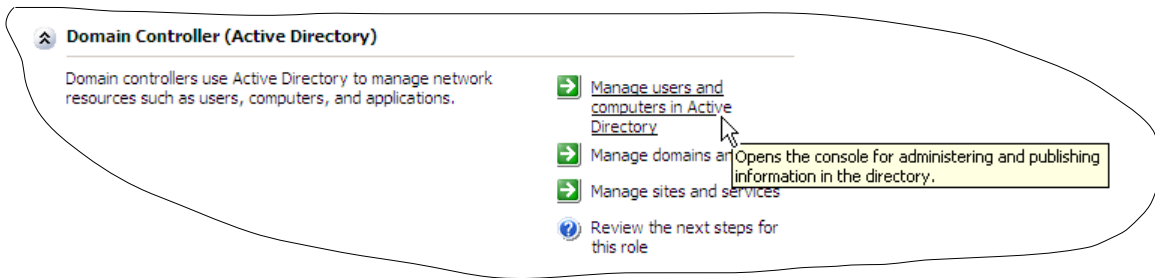



Figure 4.4.7b Manage users....

2. Right click on the relevant Domain name (symbol = ) and select 'New' then 'Organizational Unit'. Enter a name for the Unit and click OK.

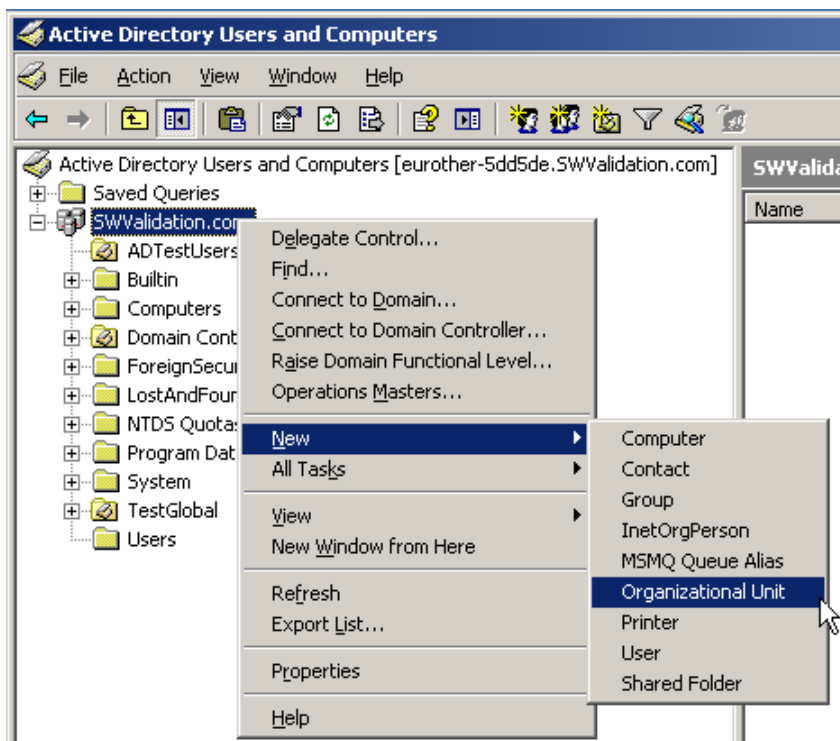

Figure 4.4.7c Create new Organizational Unit

(Continued)

4.4.7 ACTIVE DIRECTORY SERVER SETUP (Cont.)

- Similarly, create a new Group, then a new User, entering the user name and login details (figure 4.4.7d). In the password page, ensure that the various tick boxes are enabled/disabled as required.

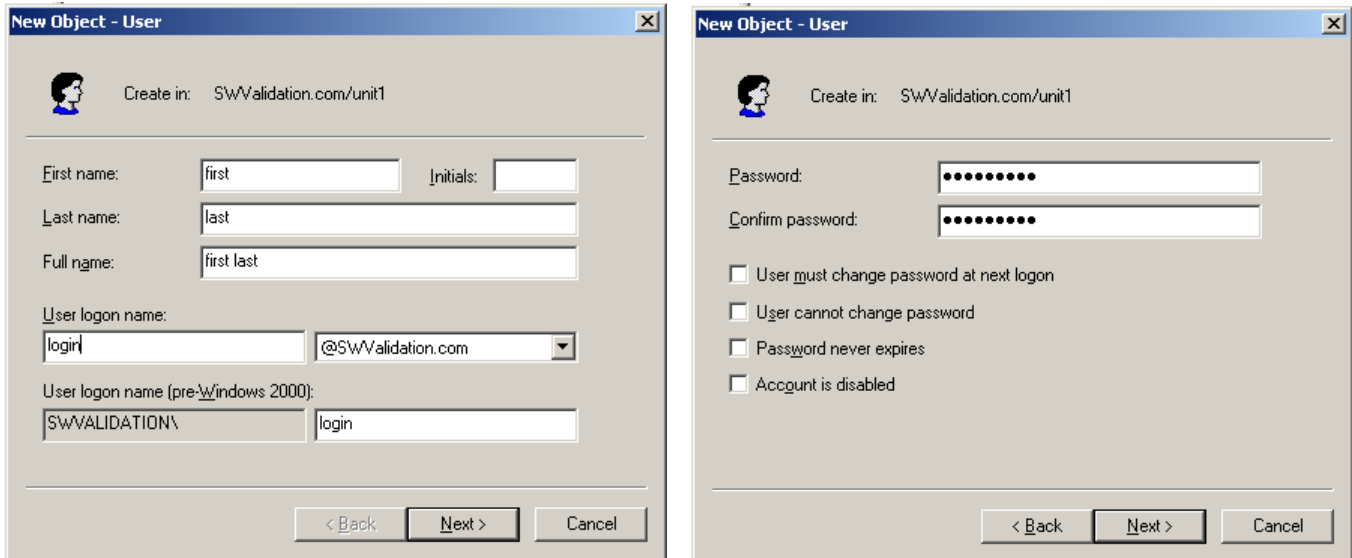

Figure 4.4.7d User details screens

- Once the new user has been created, right click anywhere in the screen and select Properties (or double click on the user). When the Properties page opens, click on the 'Member Of' tab (figure 4.4.7e).
- Click on the 'Add' key and enter the new group name Click OK.
- The user is now part of the group, and should be able to log in using the login and password details entered in step 3.

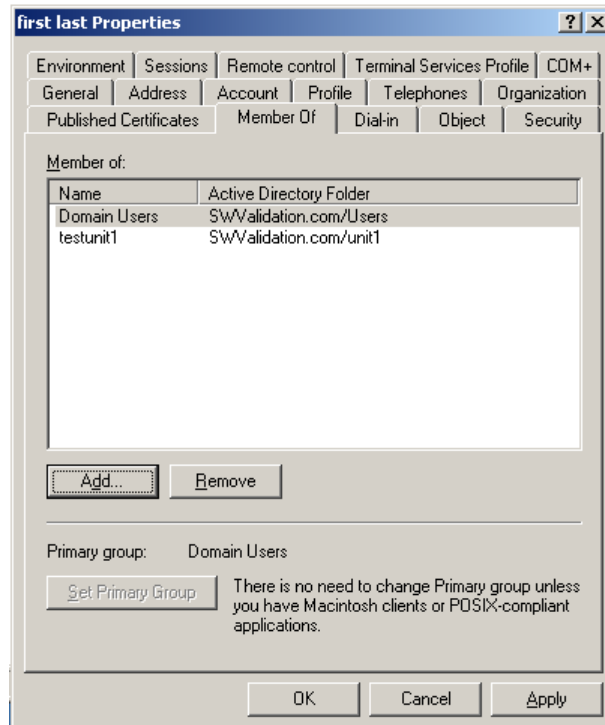

Figure 4.4.7e 'Member of' screen

4.5 NETWORK KEY

Note: This manual does not describe network setup in detail, as each network is different. In most cases, the help of the network administrator or supervisor will be required, for example, in the allocation of valid addresses and passwords.

Touching the Network key calls a selection box to the display, allowing 'Address' or 'Name' to be selected for configuration.

4.5.1 Address

Figure 4.5.1 shows the address menu fields.

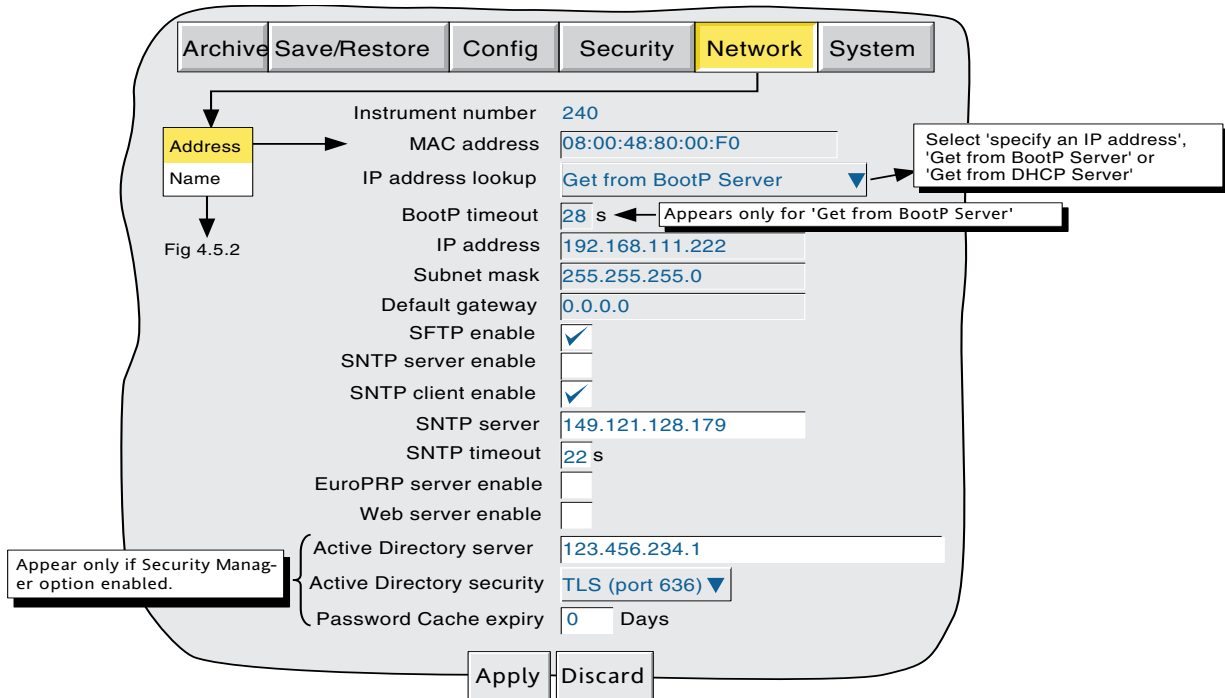

Figure 4.5.1 Network addressing

INSTRUMENT NUMBER/MAC ADDRESS

Unique numbers set up during manufacture to identify the recorder to a remote host, or to the recorder manufacturer/distributor, in case of query.

IP ADDRESS LOOKUP

This field allows an address to be entered for the recorder. This can be done either by manually entering an address (IP address field - below), or a network service BootP or DHCP can be used to assign an IP address to the recorder.

BOOTP TIMEOUT

This parameter only appears if 'IP address lookup' is set to 'Get from BootP Server'. This 28 second period is the maximum time the recorder will wait, at power-up, for a response from the BootP server. If no response is received within this time, the IP address, Subnet mask and Default gateway are all set to, or remain at '0.0.0.0'.

4.5.1 Address (Cont.)

IP ADDRESS

Allows manual entry of the recorder's internet protocol (IP) address only if 'Specify an IP address' is selected in the 'IP address lookup' picklist above.

Notes:

1. DHCP attempts to connect to the network continuously, until successful. Only when successful will the network settings be updated and appear at the address page. This can take up to 13 seconds after power up.
 2. It takes 2 to 3 minutes for a DHCP failure to be reported, so an instrument alarm would not be generated for 2 to 3 minutes after power up, should the connection fail to be established.
-

SUBNET MASK

This field is editable only if 'Specify an IP address' is selected in the 'IP address lookup' picklist above. The subnet mask is the network address plus the bits in the host address reserved for sub-network identification. By convention, all the network address bits are set to 1. The subnet mask is used to identify the subnet to which an IP address belongs by performing a bitwise AND on the mask and the IP address.

DEFAULT GATEWAY

To deliver traffic from one subnet to another, devices called 'routers' or 'gateways' are placed between segments. The default gateway address informs each network device where to send data if the target station does not reside on the same subnet as the source.

SFTP ENABLE

This tick box enables the recorder to use Secure File Transfer Protocol (SFTP). For further information see [4.8 Secure File Transfer Protocol \(SFTP\) on page 221](#).

SNTP SERVER ENABLE

This tick box allows the recorder to act as an SNTP time server.

SNTP CLIENT ENABLE

This tickbox allows time synchronisation from a Simple Network Time Protocol (SNTP) server to be enabled and disabled. When enabled, the instrument time is updated every 15 minutes.

Note: SNTP always works using UTC/GMT. Time zones are handled separately.

SNTP SERVER

If 'Obtain from BootP server' or 'Obtain from DHCP server' is selected as the IP address look-up (see above), then this address appears automatically. Otherwise this area allows an IP address to be entered for the SNTP server.

Notes:

1. SNTP is a protocol that allows clients on a TCP/IP network to set their times to that of a server - port number 123. The recorder can act both as a client and as a server; when acting as a server, the resolution is 1 msec.
2. SNTP time is based on elapsed seconds since 00:00 hrs on 1st January 1900. The time is not affected by time zones or daylight saving adjustments.
3. If the instrument time differs from the SNTP time by less than 2 seconds, the instrument time is updated gradually (1 msec 8 times a second) to prevent time change events being recorded. If the difference is greater than 2 seconds, this is defined as a 'time change event', the results of which are that the recorder time is immediately updated, and a green line is drawn across the chart (vertical/horizontal trend modes only) to indicate the time change.

4.5.1 Address (Cont.)

SNTP SERVER NOTES (Cont.)

4. If more than 5 time change events occur within 24 hours, a 'Time Synchronisation failure' instrument alarm is set 24 hours after the first event. Once synchronisation is re-established, the alarm self-clears within 24 hours.
 5. An 'SNTP server failure' instrument alarm is flagged if the configured server cannot be accessed, or if the year received from the server is less than 2001 or more than 2035.
 6. When the instrument is acting as a server and a "Clock Failure" instrument alarm is active, the server time is set to 1/1/1900 which is ignored by clients.
 7. Servers such as Microsoft 'TimeServ' cannot be used with this series of instruments because they are not SNTP servers.
 8. If the Simulation option is enabled and 'SNTP client enable' is enabled, then the recorder synchronises only on power up. If 'SNTP server enable' is enabled, the server output will follow the recorder time.
-

SNTP TIMEOUT

This parameter allows a timeout in seconds to be configured. The parameter defaults to 20 seconds ensuring that the system continues to behave as before for users who do not change this value.

EUROPRP SERVER ENABLE

Enabling this item causes the instrument to 'declare itself' (i.e. to become visible to a network scanning tool running on a PC), thus allowing the pc user to identify all such instruments on a network.

WEB SERVER ENABLE

Ticking this option enables the Web Server function, for further details see [Section Annex C: WEB SERVER DETAILS](#) on page 222.

ACTIVE DIRECTORY SERVER

This item appears only if the Security Manager option is enabled. It allows an Active Directory server IP address to be entered for use with this application. The IP address would normally be obtained from the user's IT department or Network administrator. Once entered, assuming the recorder is connected to the same network as the server, users with a domain configured will be able to login using their normal network login password.

If 'Domain name Service' is enabled ([section 4.5.2](#)), then a domain name may be entered here instead of an IP address,

ACTIVE DIRECTORY SECURITY

This item appears only if the Security Manager option is enabled. If set to None (default), then any attempt to change a password will be rejected because it has not been encrypted. One of the alternative TLS ports must be used if passwords are to be changed at the recorder.

When TLS (port 636) is selected all access to the server is secured using TLS on port 636 using the LDAP_SERVER_START_TLS_OID method. TLS (port 389) is similar but uses TLS on port 389.

PASSWORD CACHE EXPIRY

This applies only if the Active Directory is not available. Starting from when the server becomes unavailable, once the configured number of days has expired since the last successful log in (by any user), the Password cache is cleared the next time any user attempts to log in. The user's password is 'Invalid' and a pop-up message (Active Directory Password Cache has expired) appears. This means that no Domain users can log in until the Active Directory server becomes available again.

Values of 0 (default) to 30 days can be entered, where a value of 0 disables Cache expiry (i.e. it never expires).

4.5.2 Name

Figure 4.5.2 shows the 'Name' fields

The screenshot shows a configuration menu with tabs: Archive, Save/Restore, Config, Security, Network (highlighted), and System. Below the tabs, there are several fields: Address (with a sub-tab 'Name' highlighted), Local Host (Andy136-4), Domain (FishesRus.co.uk), Domain Name Service (checked), Primary DNS Server (149.121.164.11), and Secondary DNS Server (149.121.165.14). At the bottom are 'Apply' and 'Discard' buttons.

Figure 4.5.2 network name fields

LOCAL HOST

English language name for the recorder. Non-editable - assigned to the IP Address

DOMAIN

The name of the Group or area of networked units which contains the recorder. Non editable.

DOMAIN NAME SERVICE (DNS)

Enables the mapping of host names to IP addresses and vice-versa.

PRIMARY/SECONDARY DNS SERVER

IP addresses supplied by IT department or the Domain manager or Supervisor.

Notes:

1. Any one or more of the above items may be overwritten if 'IP address lookup' is set to 'Obtain from BootP Server' or 'Obtain from DHCP server' as described under 'Address' above.
2. If Domain Name Server is enabled, but either no DNS server is connected to the network or neither the DNS Primary nor secondary server can be 'found', it can take up to four minutes for the system to timeout. During this period, the recorder's user interface (touchscreen) will not respond.

4.6 SYSTEM

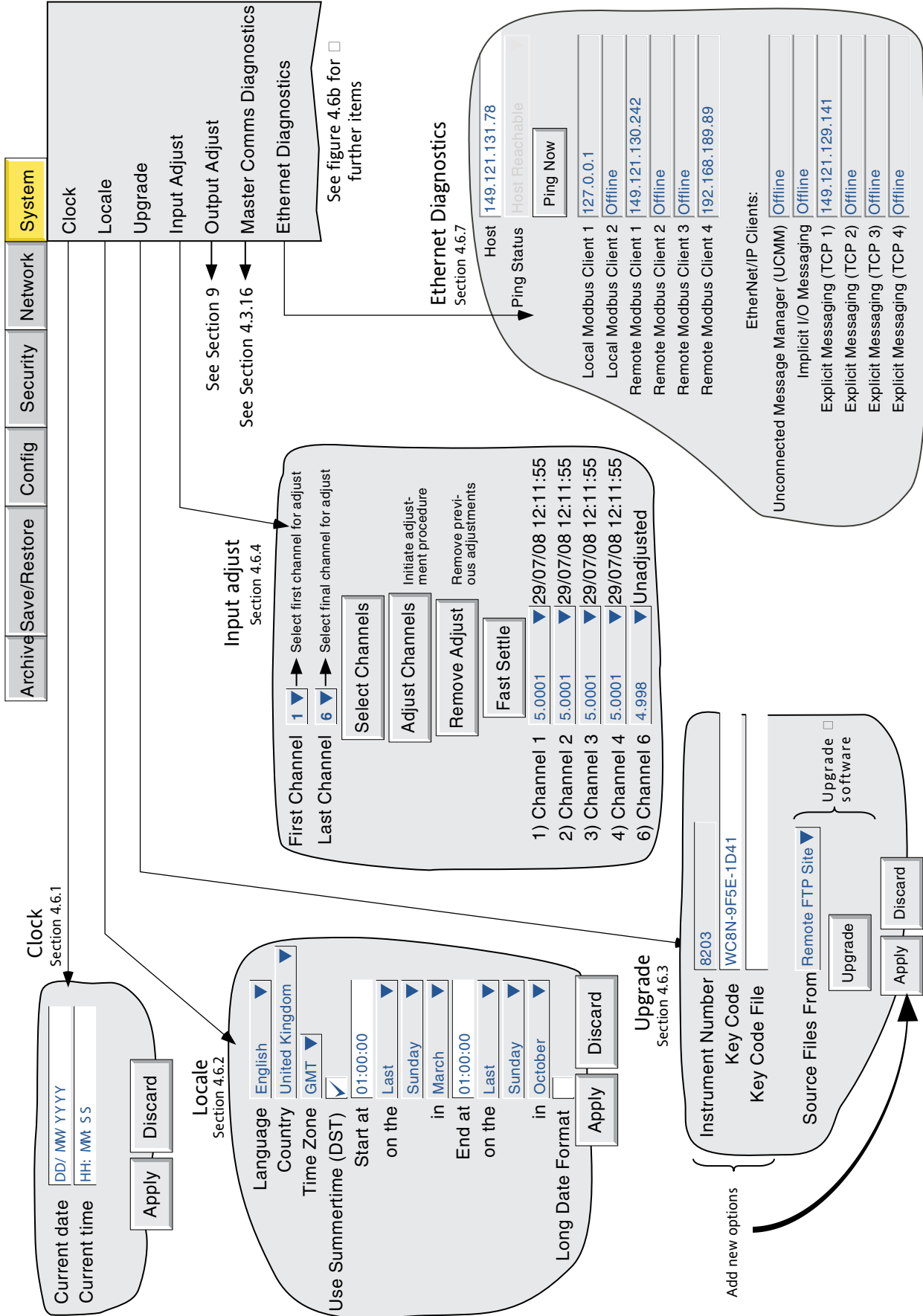

Figure 4.6a System configuration menu layout (sheet 1)

4.6 SYSTEM (Cont.)

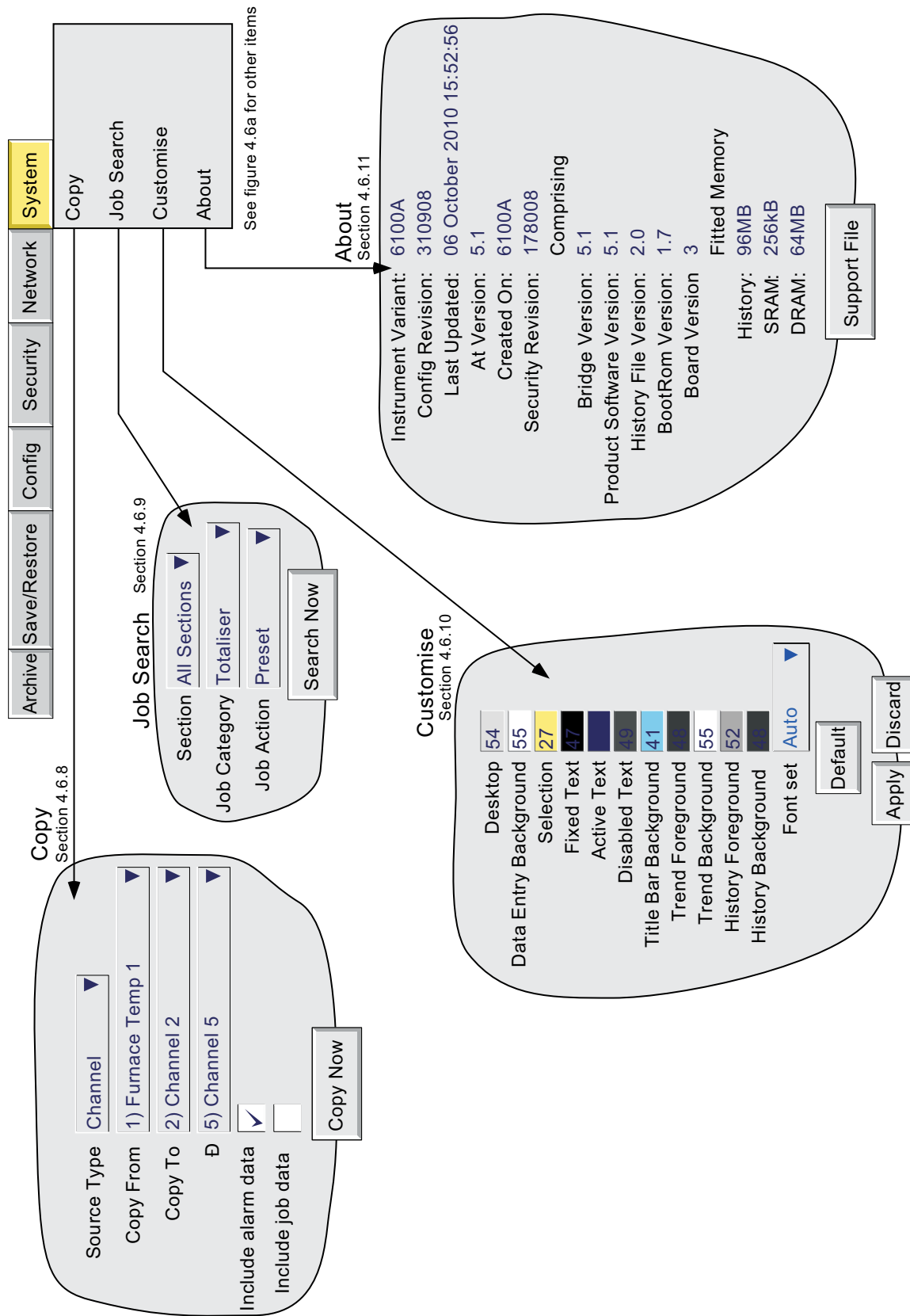

Figure 4.6b System configuration menu layout (sheet 2)

4.6 SYSTEM (Cont.)

Touching the System key calls the pick list: Clock, Locale, Upgrade, Input adjust, Master Comms Diagnostics (if option fitted), Ethernet diagnostics, Copy, Job search, About.

Figures 4.6a and 4.6b above, give an overview of the System Menus.

4.6.1 Clock

Selecting 'clock' causes the recorder's date and time to be displayed. To edit the date, touch the current date area, to call the keyboard and enter the new numbers. The date is edited in a similar way. The settings apply as soon as the 'Apply settings' button is touched. See also SNTP details in [section 4.5.1](#).

4.6.2 Locale

This allows the setting of the following items:

Language	Choose the required language from the picklist
Country	Displays a pick list of countries associated with the selected language
Time zone*	Select required time zone from picklist.
Use Summertime (DST)*	Select box if daylight saving is to be used, If 'Use Summertime (DST)' is selected, the times and dates for the start and end of summertime can be entered using picklists - see figure 4.6a.

Notes

- 1 Date format DD/MM/YY or MM/DD/YY is defined by the language and country selected. Time format (e.g. 12/24 hr. clock) is defined by the country selected.
2. When using Bridge software, the host PC's locale information and the recorder locale information should match, or the displayed time will not be correct.

*Note: For more information, see [B7 Annex B](#) and/or <http://www.timeanddate.com>

LONG DATE FORMAT

Table 4.6.2 shows some examples of the Standard and Long Format date layouts which are available according to Language and Country selections.

Country (Language)	Date display	
	Standard	Long Format
Argentina	01/05/06	01/05/2006
Australia	1/05/06	1/05/2006
Bolivia	01-05-06	01-05-2006
Canada (Eng)	01/05/06	1-May-06
Canada (Fra)	06-05-01	06-05-01
France	01/05/06	1 mai 06
Germany	01.05.06	01.05.2006
Holland	1-5-06	1-mei-06
Italy	01/05/06	1-Mag-06
Portugal	01-05-2006	1/Mai/06
South Africa	06/05/01	2006/05/01
Spain	1/05/06	01-may-06
Switzerland (Fra)	01.05.06	1 mai 06
Switzerland (Ger)	01.05.06	01.05.2006
Switzerland (Ita)	01.05.06	1-mag-06
United Kingdom	01/05/06	01-May-06
United States	5/1/06	01-May-06
Uruguay	01/05/06	01/05/2006

Table 4.6.2 Date format examples

4.6.3 Upgrade

This allows

1. New options to be enabled (by the entering of a 'Key Code') and/or
2. The recorder operating software to be upgraded by reading a file from Compact Flash, SD card or other local or remote source.

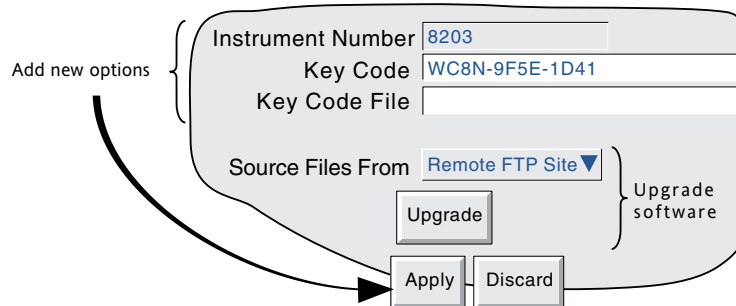

Figure 4.6.3a Upgrade menu

Instrument Number	This number must be quoted when ordering upgrades. It is unique to the instrument and is not user editable.
Key Code	If the relevant key code is known, it can be entered manually using this field
Key Code File	If Key Code File is selected, the first line of the file must be the Key Code. To select the file for reading, the Key Code File field is touched, to display the file list - if necessary, refer to section 5, below, for more details.
Source Files From	Allows the user to select 'Remote FTP/(S)FTP site' or 'Local Media'.
Upgrade	Initiates upgrade once the upgrade source has been defined (see figures below).

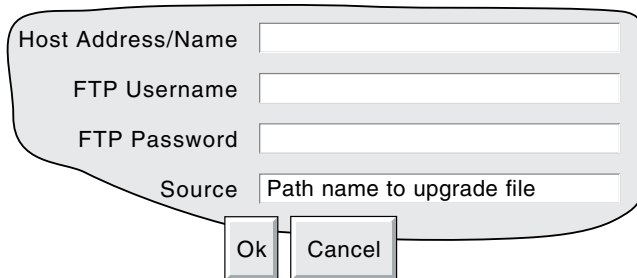

Figure 4.6.3b Remote upgrade details

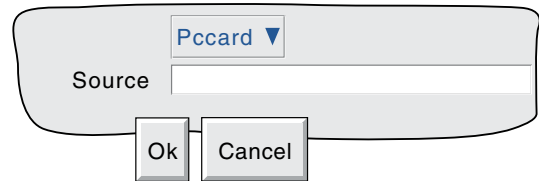

Figure 4.6.3c Local upgrade details

CAUTION

Power to the recorder must be maintained during the upgrade process or the recorder might not power up. If such a situation arises, the manufacturer's local service centre should be contacted for advice.

Notes:

1. Recording is suspended and the user interface (touchscreen) is disabled whilst the upgrade is in progress. During the subsequent, automatic power cycle, any alarm relays will go into their alarm states until the recorder has re-initialised.
2. When upgrading from another instrument, using 'Remote Upgrade', the I.P. address (or network name) of the source instrument should be typed into the Host Address/Name field, and 'mediacard' (or usbfront etc. as appropriate) should be entered in the 'Source' field.
3. If 'Audit trail' is enabled (see 'Management' - section 4.4.2), then system messages are generated, containing date, time, source and status details of the upgrade.
4. 'Upgrade' appears in the System menu only for access levels which have 'Perform Upgrades' enabled in Security/Access configuration (section 4.4.1).
5. 'Signing/Authorizing' apply to upgrades, if the relevant boxes are ticked in Security/Management configuration. See 'Management' - section 4.4.2 for further details.

4.6.4 Input adjust

Notes

1. Input adjust cannot be applied to input channels with input type of 'Digital', 'Test' or 'comms'.
2. Input adjustments can be carried out only by users with 'Adjust I/O' permission (see section 4.4.1).
3. The instrument must be powered for a sufficient time (e.g. 30 mins) for it to reach thermal equilibrium before an input adjust is performed.

This facility allows the user to compensate for tolerance errors etc. The technique used is to select those channels to which adjust is to be applied, then for each channel to:

- a. apply a known low level signal (at or close to the low input range value) to the relevant input. When the recorder reading is steady, press 'Apply'.
- b. apply a known high level signal (at, or close to, the high input range value) to the relevant input. When the recorder reading is steady, press 'Apply'.

Figure 4.6.4a shows the initial display which appears when 'Input adjust' is first selected from the SYSTEM menu. Channels 1 to 6 are selected by default.

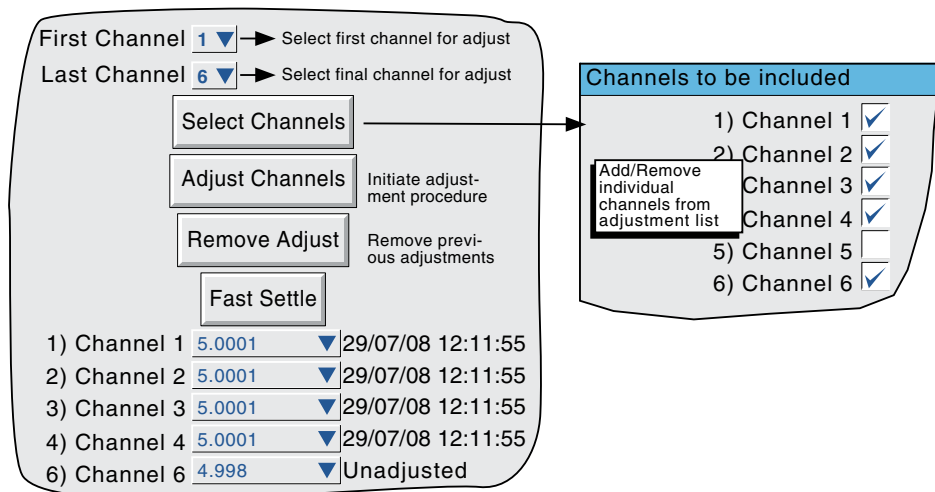

Figure 4.6.4a Input adjust status page

First channel	Allows the user to select the lowest channel number of all the channels to be adjusted.
Last channel	Allows the user to select the highest channel number of all the channels to be adjusted.
Select Channels	Presents a list of all the channels from the First channel to the Last channel inclusive, each of which can be removed from the adjustment list by 'unticking' its check box. The channels displayed in the status page reflect this selection.
Adjust channels	Initiates the adjustment procedure to all the channels from the First channel to the Last channel inclusive, unless the effectivity is modified using the Select Channels key.
Remove Adjust	Returns the selected channels to factory calibration
Fast Settle	Switches off the input filter for 1 second, to allow quicker response. Adjust Channels' values displayed as 'RANGING' for the 1 second duration.
1) Channel 1 etc.	A list of channels required to be susceptible to the adjustment procedure, together with their current values and their adjustment status (i.e. Unadjusted or, the time/date of the previous adjustment (if any)).

4.6.4 INPUT ADJUST (Cont.)

ADJUST PROCEDURE

Operation of the Adjust Channels key calls the low-end adjust page, as shown in figure 4.6.4b.

Fast settle

Specify the sensor low point and connect the corresponding input.

Low Point

When the values below have settled select Apply.

1)	Channel 1	<input type="text" value="-0.0026"/>	Unadjusted
2)	Channel 2	<input type="text" value="-0.0001"/>	Unadjusted
3)	Channel 3	<input type="text" value="-0.0002"/>	Unadjusted
4)	Channel 4	<input type="text" value="-0.0002"/>	Unadjusted
6)	Channel 6	<input type="text" value="0.0000"/>	Unadjusted

Figure 4.6.4b Typical low-end input adjust page

Fast Settle
Low Point

Reduces the time taken for the readings to stabilise.
Usually 0, but a different value can be entered here, if required.

Apply the Low point value to the relevant input channels, and wait for the recorder readings to become stable. When the readings are stable, press the Apply key, to call the High-end page depicted in figure 4.6.4c, below.

Fast settle

Specify the sensor high point and connect the corresponding input.

High Point

When the values below have settled select Apply.

1)	Channel 1	<input type="text" value="4.9993"/>	Unadjusted
2)	Channel 2	<input type="text" value="4.9972"/>	Unadjusted
3)	Channel 3	<input type="text" value="5.0010"/>	Unadjusted
4)	Channel 4	<input type="text" value="4.9994"/>	Unadjusted
6)	Channel 6	<input type="text" value="5.0110"/>	Unadjusted

Figure 4.6.4c Typical high-end input adjust page

Fast Settle
High Point

Reduces the time taken for the readings to stabilise.
Default value displayed, but a different value can be entered here, if required.

Apply the High point value to the relevant input channels, and wait some minutes for the recorder readings to become stable. When the readings are stable, press the Apply key, to return to the status page.

Note: Adjusting a channel invalidates the accuracy values given in the specification in Annex A for that channel.

4.6.5 Output Adjust

Applies only to units with Analogue output option boards fitted. See [section 9](#) for details.

4.6.6 Master Comms Diagnostics

This menu item is concerned only with Master comms diagnostics, and is fully described in [Section 4.3.16](#).

4.6.7 Ethernet Diagnostics

This screen (figure 4.6.7) allows the user to test the status of the connection with a host computer, and if the relevant option is enabled, the connections with local and remote Modbus or EtherNet/IP slaves. The page is available to any access level with 'Full Configuration' enabled in Security/Access configuration ([section 4.4.1](#)).

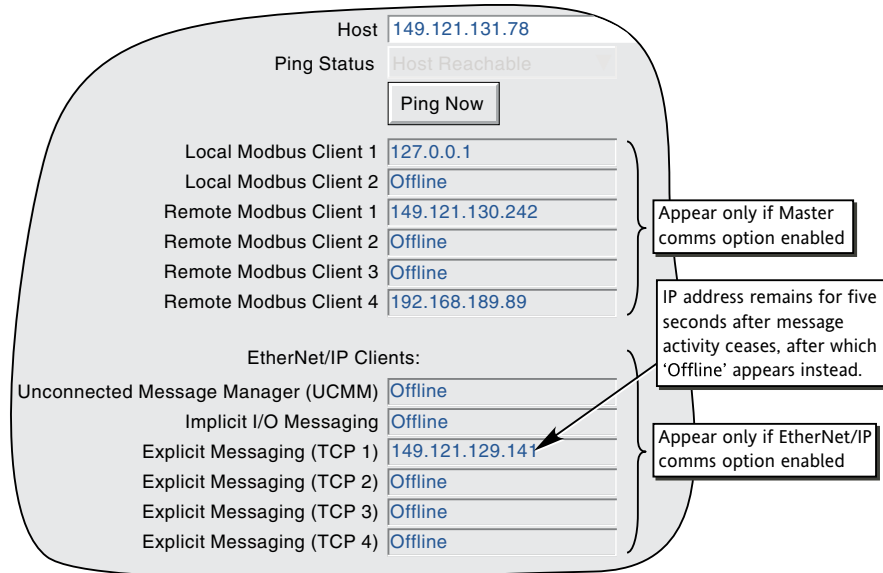

Figure 4.6.7 Ethernet Diagnostics display

Host
Ping Status

Allows the IP address, or DNS Name of the host to be 'Pinged'.
Indicates the latest status returned - see table 4.6.7, below, for details.

Displayed Status	Interpretation
Waiting	The default status displayed on power up.
In Progress	Displayed whilst waiting for a response from the host
Host Reachable	A device was found at the specified address.
Ping (Error in value)	Host refused to allow socket connection on the defined Ping Port.
Request Timed Out	Unable to reach a host at the specified network address.
Host Unreachable	Unable to reach a host at the specified network address.
Unknown error	An unknown internal error has occurred.

Table 4.6.7 Ping Status

Ping Now

Operating this button causes an Internet Control Message Protocol (ICMP) command to be sent to the host. If the host receives the message, it returns a message to the sender within a few seconds.

Local Modbus Client

Appears only if the Master Comms option is enabled. Indicates that the local Modbus Master is connected.

Remote Modbus Client

Appears only if the Master Comms option is enabled. Displays the IP address of connected Modbus TCP/IP clients. Otherwise 'Offline' is displayed.

4.6.7 ETHERNET DIAGNOSTICS (Cont.)

EtherNet/IP Clients Appears only if the EtherNet/IP comms option is enabled.

Unconnected Message Manager (UCMM)

Displays the IP address of any client requesting an 'unconnected' message (see [section 4.3.21](#)).

Implicit I/O Messaging

Displays the IP address of the client currently carrying out implicit messaging. Once activity ceases, the address remains on display for five seconds, after which 'Offline' appears instead.

Explicit Messaging (TCPn)

Displays the IP address of each client currently carrying out explicit messaging. Once activity ceases, the address remains on display for five seconds, after which 'Offline' appears instead.

4.6.8 Copy

This facility allows the user to copy a point or group configuration from one point, group etc. to one or more others. The user may choose whether or not to include alarm and (if applicable) job data when copying point configurations. Descriptors and colour selections are not copied.

Figure 4.6.8 shows a typical configuration page for copying the configuration of channel 1 (Furnace Temp1) to channels 2 to 5 inclusive.

Figure 4.6.8 Copy configuration page (typical)

When 'Copy Now' is operated, a confirmatory dialogue box opens, to allow the user to check the source and destination entries.

4.6.8 COPY (Cont.)

CONFIGURABLE PARAMETERS

Source Type	Picklist allows selection of Group, Channel, Event, Message, Maths Channel, Totaliser, Counter, Timer, Output or Demand Write, as the type of source to be copied.
Copy From	Allows the user to select a specific point, group etc. to be copied
Copy To	Allows the first destination point to be selected, for the source to be copied to.
-	Allows the final destination point to be selected for the source to be copied to.
Include alarm data	This field appears only for source types which support alarms. If this box is 'selected', then alarm data is included in the copy process.
Include job data	This field appears only for source types which support jobs. If this box is 'selected', then jobs data is included in the copy. For source types that support both alarms and jobs, it is not possible to include job data, without including alarm data as well.

Once the copy is complete, the user should enter the configuration area of the items that have been copied, and edit/apply the changes etc.

COPY RULES

1. The first channel on any input card may not be a digital input type.
2. If a destination channel was a digital input, AND the source channel is an analogue input AND 'include alarm data' is not selected, the destination channel alarm settings will be set as:
Enable = Off; Type = Absolute high; Threshold = 0.0; Dwell = 0.0.
3. If a destination channel was an analogue input, AND the source channel is a digital input AND 'include alarm data' is not selected, the destination channel alarm settings will be set as:
Enable = Off; Type = Digital; Threshold = Closed; Dwell = 0.0.
4. Descriptors and Colours are never copied.

4.6.9 Job search

With multiple job sources, it can sometimes be difficult to discover what the trigger for a particular job is, particularly if the recorder has been configured by more than one operator. The 'Job Search' facility allows the user to define a job type, and the recorder then produces a list of relevant triggers. Figure 4.6.9 shows a typical search page, which will produce a list of all triggers for Preset Totaliser jobs.

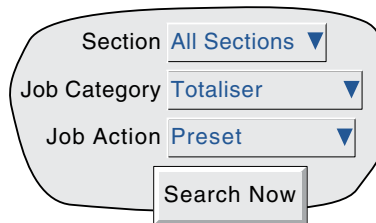

Figure 4.6.9a Job search

Section	Allows the user to select a point type for the search. For example, selecting 'Maths', causes the search to be restricted to Maths channels. 'All Sections' causes all enabled point types to be included in the search.
Job Category	Allows a job category (e.g. 'Totaliser') to be selected for the search.
Job Action	This depends on the job category. For example, for 'Totalisers', 'Preset', 'Disable', 'Preset Group' or 'Disable Group' to be selected. Section 4.7 gives details of all job types and their associated actions.
Search Now	Operation of this button initiates the search, after confirmation.

SEARCH RESULTS

The search results in one of two displays, one 'No Match was found' if no jobs are found which match the search criteria, or a list of triggers is produced. A typical example is given in figure 4.6.9b.

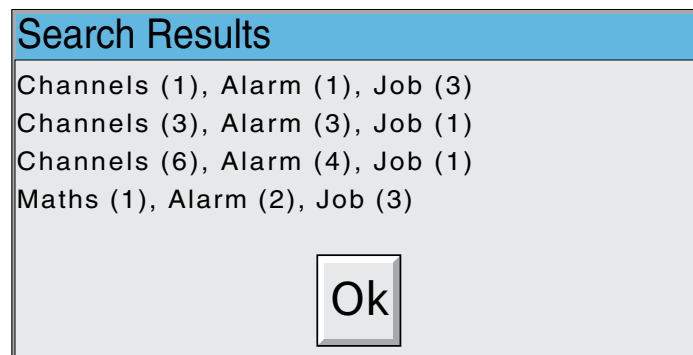

Figure 4.6.9b Search results (typical)

4.6.10 Customise

'Customise' allows:

1. the background and foreground colours for various screen items to be selected
2. the size of the text font to be varied.

Figure 4.6.10a shows the display page with the settings used for most of the screen drawings in this manual.

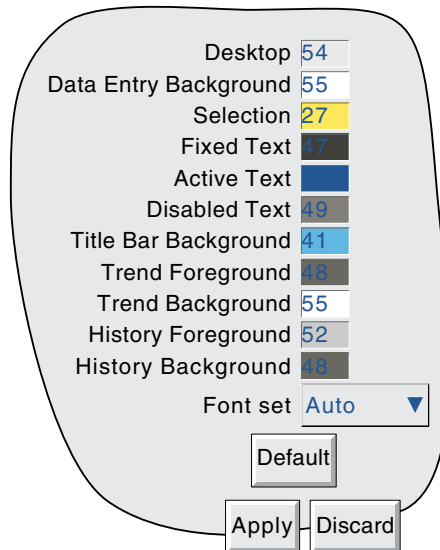

Figure 4.6.10a Customise menu

Desktop	This defines the background colour for the display screens, including keytops.
Data Entry Background	
Selection	This is the background colour for drop-down menus and text entry areas.
Fixed Text	The colour that keytops and menu items adopt when selected.
Active Text	This defines the colour of all fixed text items including key top text, menu text, scale data, title bar legends etc.
Disabled Text	The colour of all non-fixed text, such as selectable menu items.
Title Bar background	This allows the user to choose a colour for the text associated with disabled items. For example: key top legends on the Goto Group menu, for groups that are not display enabled.
Trend Foreground	The colour of the title bar block at the top of the display screen. Note that the text colour for the title block is that defined in 'Fixed Text', above.
Trend Background	The colour of the grid lines, timestamps and messages on the real-time trend display.
History Foreground	The colour of the 'chart' in the real-time trend display.
History Background	The colour of the grid lines, timestamps and messages on the trend history display.
Font set	The colour of the 'chart' in the trend history display.
Default	Allows the user to select a size for the display font. This affects the size of the 'containing item' i.e. push button keys etc. also change size. See 'FONT SIZE EXAMPLES', below.
	Allows the user to return to the factory default settings.

4.6.10 CUSTOMISE (Cont.)

FONT SIZE EXAMPLES

The following figures give examples, drawn to the same scale, for all of the different font sizes available, except 'Auto' which picks a font size considered appropriate for the size of screen.

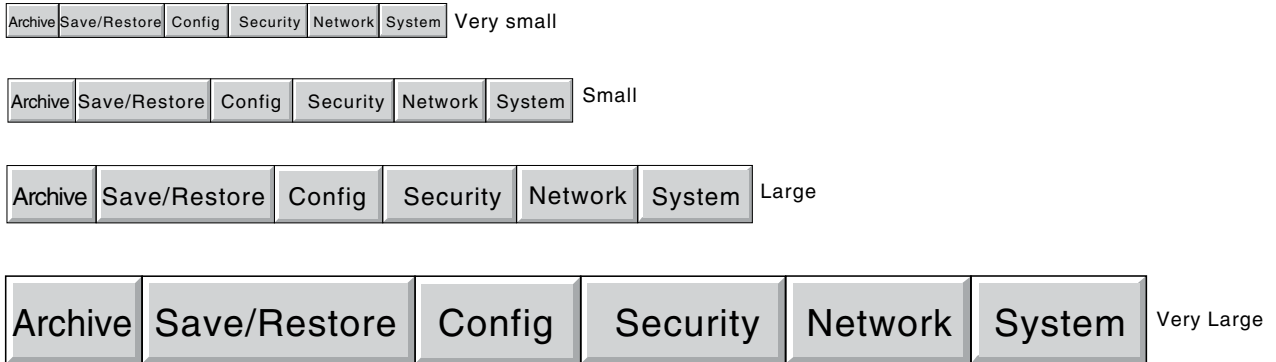

Figure 4.6.10b Font sizes

4.6.11 About

Selecting 'About' from the System key menu gives details of the version numbers of different aspects of the recorder, and details of the amount of memory fitted. Figure 4.6.11 shows a typical 'About' display page.

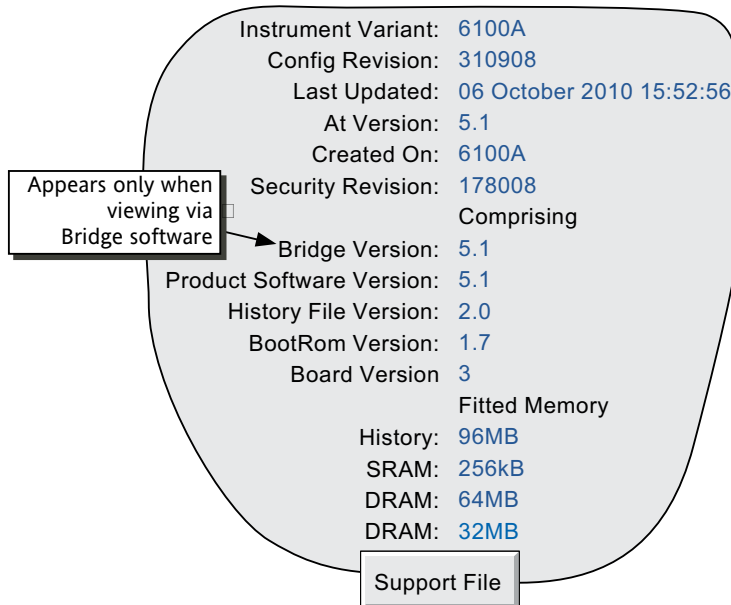

Figure 4.6.11 About display (typical).

INSTRUMENT VARIANT

Displays the instrument type.

CONFIG REVISION

Whenever a change to the Configuration of the recorder is applied the 'Config Revision' is incremented. For these purposes, Configuration is defined as including all items within the menu structures of the Config and Network keys, and includes User Screens. It does not include those items associated with the Security key. Config Revision is printed on the 'chart' at power up, and if either Auditor option or if the Batch option is fitted, Config Revision is included in the messages associated with these options.

Notes:

1. Config Revision can be used as an input to one or more maths channels. If such a maths channel is included in one or more groups, the revision number can be determined for any time/date, when Trend History mode is invoked for the group(s) in question. See [section 4.3.11](#) for maths function details.
2. Config Revision can be embedded in one or more messages, as described in [section 4.3.8](#).

LAST UPDATED

The time and date at which the configuration was last edited.

AT VERSION

The version number at the time of the last configuration update.

CREATED ON

Shows the type of instrument that the configuration was created on. Normally, this will be the same as 'Instrument Variant', and will be different only if the configuration has been downloaded from a different instrument model.

4.6.11 ABOUT (Cont.)

SECURITY REVISION

Whenever a change is made to an item within the Security menus, the Security revision is incremented. Security Revision is printed on the 'chart' at power up, and if either of the Auditor options or if the Batch option is fitted, Security Revision is included in the messages associated with these options. See notes 1 and 2, below.

Notes:

- 1 Security Revision can be used as an input to one or more maths channels. If such a maths channel is included in one or more groups, the revision number can be determined for any time/date, when Trend History mode is invoked for the group(s) in question. See [section 4.3.11](#) for maths option details.
 2. If 'Centralised Security' is enabled, the Security Revision is in a different format (e.g. 15.001) see [section 4.4.2](#).
-

SUPPORT FILE

If the unit is not performing as it should (e.g. it resets itself unexpectedly), the Support File key allows the user to save 'critical system files' into a single file (SupportInfo.uhq*), for despatch to the manufacturer for analysis. This file may be saved to the instrument's Compact Flash or SD card or, using Bridge 'Full' software, to a remote PC. For security reasons, this file cannot be viewed by anyone other than the manufacturer or his agents.

Once the save operation is complete, a 'Support' message appears on the screen giving details of where to send the file. More information is held in the file 'SupportInfo.txt' which is also saved to the disk. This file can be opened, and the information within it read, by inserting the disk into a PC, clicking on the floppy disk icon (A drive) in 'My Computer' and then double clicking on the file icon when it appears.

* 'SupportInfo' is the default name. This name may be edited by the user before saving to disk or pc. The .uhq suffix is automatically appended to the new name.

4.7 JOBS

A number of sources (e.g. channel, event, totaliser) can be set up to trigger one or more jobs. The following description includes all possible job categories, but which jobs are available on any particular recorder depends on the options fitted to that recorder. Many job categories require the relevant access level permission to be set, as described in [section 4.4.1](#), above.

The type of action (continuous or 'single-shot'), available for selection, depends on the type of trigger source. Continuous actions are selected from: While active, While inactive or While unacknowledged. The available single-shot actions are: On becoming active, On becoming inactive, On acknowledgement.

4.7.1 No Action

This means that no job action is configured for the trigger source.

4.7.2 Drive relay category

Allows a specific relay to be set up to change state whilst the trigger source is active, inactive or whilst it remains unacknowledged. Relays are normally energised i.e. 'common' (c) is shorted to 'normally open' (no). When in alarm, the relay is de-energised i.e. 'common' (c) is shorted to 'normally closed' (nc). Thus, if power is removed from the recorder, all relays automatically 'fail safe' to their alarm conditions. See [section 2.2.1](#) for details of relay output board connector location(s) and pinout.

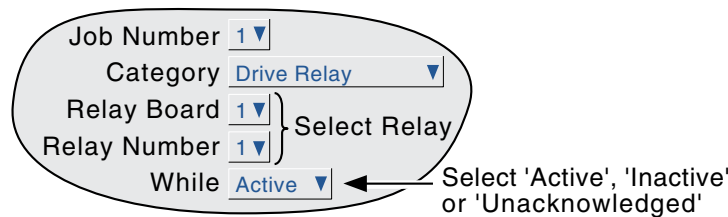

Figure 4.7.2 Relay job menu layout

4.7.3 Totaliser category

If the Totaliser option is fitted ([section 4.3.12](#)), the following jobs become available:

Preset	Loads the selected totaliser with the value set up in 'Preset' in the totaliser's configuration menu.
Preset Group	Loads all the totalisers in the specified group with their 'Preset' values.
Disable	Stops the specified totaliser accumulating.
Disable Group	Stops all totalisers in the specified group.

Note: If more than one job is set up to disable a particular totaliser, then any of these jobs going active will disable the totaliser.

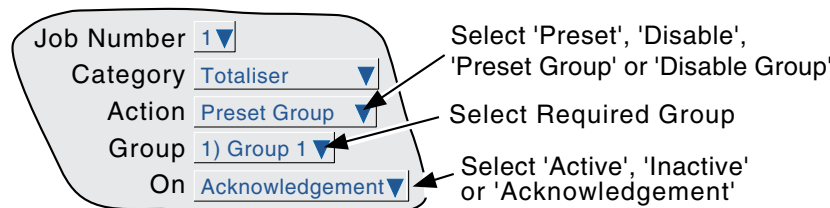

Figure 4.7.3 Totaliser job menu layout (group action)

4.7.4 Message category

One or more messages ([section 4.3.8](#)) can be directed to the display, to 'All groups' or to a 'Specified Group'. The messages must be contiguous - e.g. messages 2, 3 and 4 may be sent, but messages 1, 3 and 4 cannot be sent, without message 2 as well.

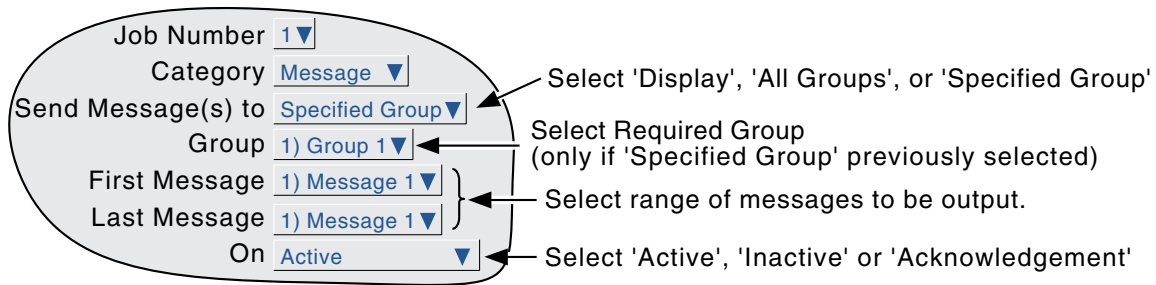

Figure 4.7.4 Message job menu layout

4.7.5 Maths category

If Maths channels ([section 4.3.11](#)) are enabled, the following jobs become available to applicable functions:

Reset	Sets the selected maths channel value to zero.
Disable	Stops historical functions such as Fvalue, Stopwatch and Rolling Average from accumulating further values. When the function is subsequently re-enabled, the function re-starts from its pre-disabled value. 'Disable' has no effect on other functions.
Switch to B	Causes the relevant maths channel to copy source B instead of its normal source A - see section 4.3.11 for further details.
Trigger	Used to initiate a 'Sample and hold' function - see section 4.3.11 for further details.

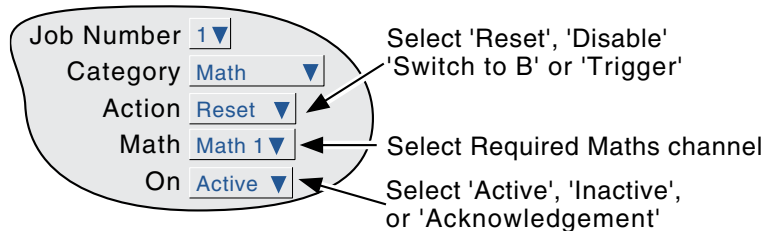

Figure 4.7.5 Maths job menu layout

4.7.6 Clock category

This job causes the System Clock to be Preset to the value entered in Instrument Configuration (Preset Hour, Preset Minute) (Section 4.3.1). This job can be used to synchronise a number of recorders as follows:

- For each recorder, set up one input channel as

Input Type	Digital
Closed String	Synch (for example)
Enable	Trigger
Active when	Synch
Job 1 category	Clock
Job 1 action	Preset
Job 1 On	Active
- For each recorder, set the same preset hour and minute in Instrument Configuration.
- For each recorder provide a simultaneous pulse or contact closure to the digital input previously set up. The recorders will all be automatically set to the preset time on receipt of the input.

An alternative way of synchronising recorders is via an SNTP time server as described in section 4.5.1.

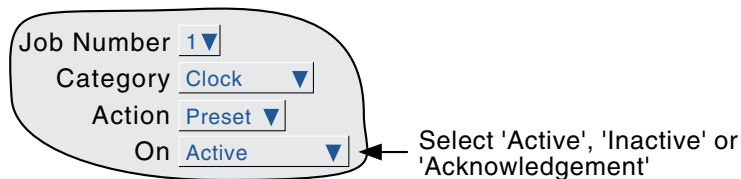

Figure 4.7.6 Clock job menu layout

Notes

- Whenever a time change occurs, a green line is drawn across the chart in vertical trend mode.
- The clock presets to the 'Preset Hour' value set in Config/Instrument menu. If, however, 'Use Summertime (DST)' is enabled in System/Locale configuration, then an hour is added whilst daylight saving time is in operation.

4.7.7 Counter category

If Counters (section 4.3.13) are enabled, the following jobs become available:

- | | |
|-----------------|---|
| Preset counter | Loads the selected counter with the preset value set in the configuration for that counter. |
| Disable counter | Stops the selected counter. |
| Increment | Adds 1 to the selected counter's value. |
| Decrement | Subtracts 1 from the selected counter's value. |
| Preset group | Loads all the counters in the specified group with their 'Preset' values. |
| Disable group | Stops all counters in the specified group. |

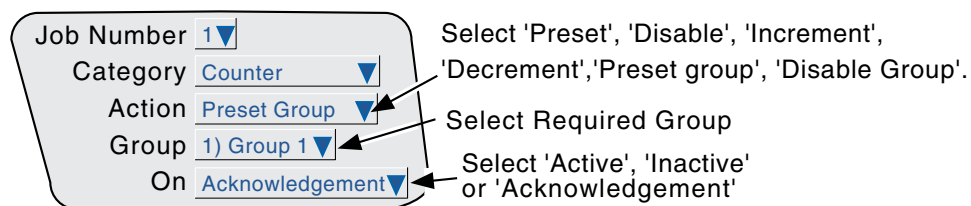

Figure 4.7.7 Counter job menu layout (group action)

4.7.8 Timer category

The following jobs are available:

1. Reset timer - sets the timer to zero
2. Start timer - causes the timer to start.
3. Disable timer - stops the timer.

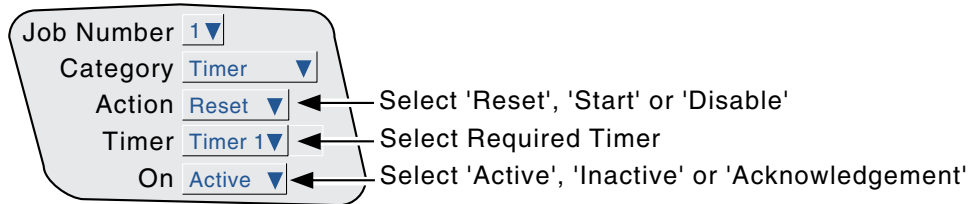

Figure 4.7.8 Timer job menu layout

4.7.9 Batch category

If the Batch option ([section 4.3.10](#)) is fitted, a previously 'Stored' batch can be started by job action or by a Batch Start command sent via MODBUS/TCP ([section 8](#)). If a batch is already running, it will be restarted. In Batch configuration, if Scope = Group, then a specific group can be selected for the batch job to act on; if Scope = Instrument, the Group selection field does not appear.

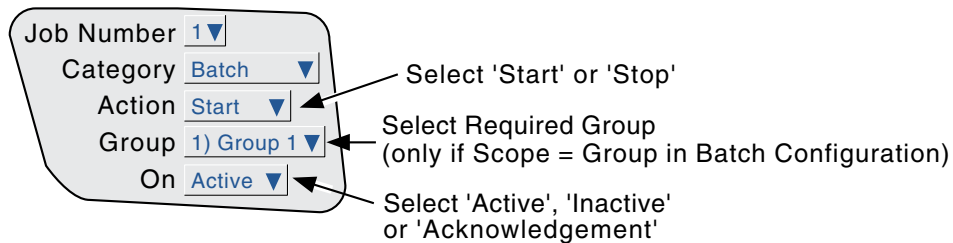

Figure 4.7.9 Batch job menu layout

4.7.10 Recording category

The following 'Recording jobs' are available:

Enable	This enables recording to the group's history file, 'while active', 'while inactive' or 'while unacknowledged'. This allows, for example, recording to be enabled (job 2) only whilst a Trend Freeze job (job 1) is inactive (i.e recording is disabled for the duration of a Trend Freeze job). Trend freeze is described in section 4.7.11, below.
Speed/Interval B	Recording speed/interval B is selected for use, for the duration of the job. See 'Group configuration for A/B switching details.
Erase all History	All recorder history is erased (only if Simulation option - section 4.3.22 - is enabled), but see also note 4.

Notes:

- 1 The group in question will be recorded only if Recording Enable selected in group Configuration ([section 4.3.2](#)) and the job is active.
2. If Audit Trail ([section 4.4.2](#)) is enabled, then in order to preserve the audit trail, messages will be saved in the group's history files even when recording is not enabled by job.
3. A blue line is drawn across the 'chart' whenever a recording job is used to disable/enable recording.
4. If the 21CFR11 option is enabled, 'Erase All History' jobs can be triggered, but are ignored, leaving the recording history unaffected.

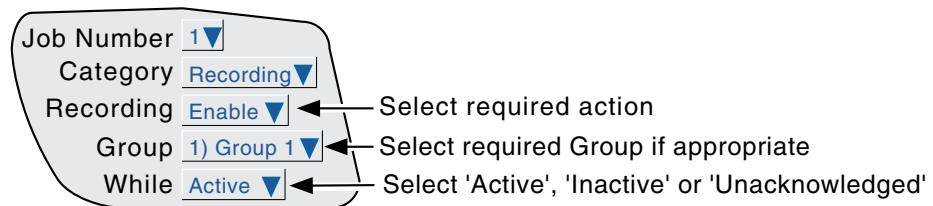

Figure 4.7.10 Recording job menu layout

4.7.11 Trend category

Trend jobs allow the following actions to occur:

Span B	Switches the point being configured to span B and zone B, for as long as the job is active.
Span B Group	Switches all the points in the selected group to their individual spans and zones B, for as long as the job is active.
Colour B	Switches the point being configured to colour B, for as long as the job is active.
Colour B Group	Switches all the points in the selected group to their individual colours B, for as long as the job is active.
Speed/Interval B	Switches Trend Speed/Interval for the selected group to Speed/Interval B, for as long as the job is active.

Note: If a 'B' value has not been set, the default 'A' value will be used instead

If the Simulation option ([section 4.3.22](#)) is enabled the following additional Trend jobs become available:

Freeze	Freezes process variables and trend displays, stops the recorder clock and stops data further writing of history files (but see note). When the job deactivates, process values/trends are updated to their current values, the clock restarts from its frozen value and writing to history files is resumed. No blue line is drawn across the chart.
Clear	Clears the trend displays from the screen.
Saver Display	Sets the recorder display brightness to the value set up in 'Saver display' in Instrument configuration (section 4.3.1). Overrides the 'Save after' value.

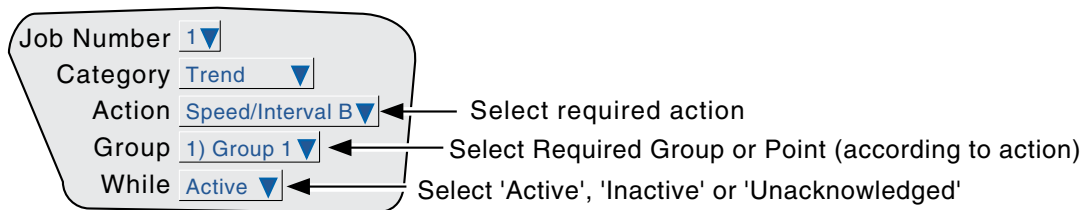

Figure 4.7.11 Trend job menu layout

Note: in order to ensure that no further data is written to the recorder's history files, recording must be disabled by setting a second, 'Recording', job to be initiated by the same trigger as initiates the Freeze job. This Recording job should be set to 'Enable', 'while Inactive'. Recording jobs are described in [section 4.7.10](#), above.

4.7.12 Output category

Applies only to recorders with Modbus master comms option fitted. As described in [section 4.3.16](#), when Modbus Master is enabled, a number of 'Output channels' become available for configuration. This feature allows any specified recorder point to be copied to a destination instrument's input channel, if this is set to Input Type = Slave comms.

An output job allows a specific output channel write to be disabled when the recorder is acting as a modbus master.

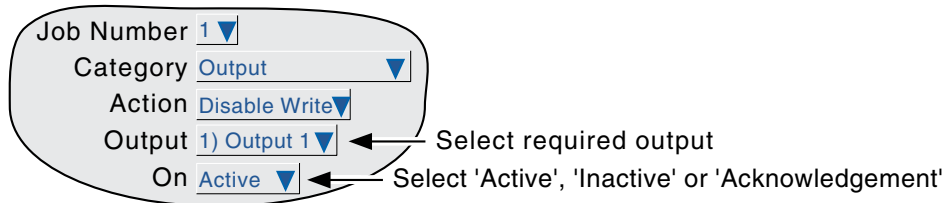

Figure 4.7.12 Output Job menu layout

4.7.13 Demand Writes category

Applies only to recorders with Modbus master comms option fitted.

Demand Writes jobs allow the user to set up the recorder so that, when the job is triggered, it initiates the selected Demand Write. The write action is performed to the remote device as defined in Demand Write Configuration described in [section 4.3.18](#).

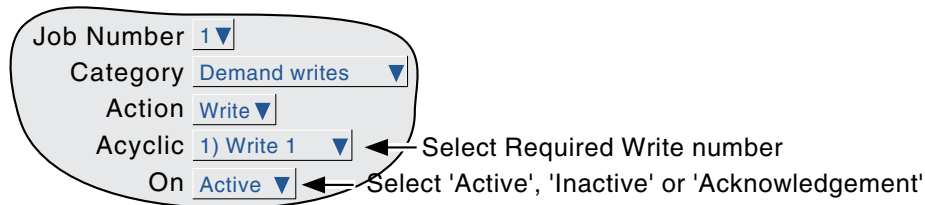

Figure 4.7.13 Demand write jobs menu layout

4.7.14 Alarm category

This allows the user to set up a job to acknowledge or disable point alarms as follows:

Acknowledge All Alarms	Acknowledges all alarms	
Acknowledge Alarms on Group	Acknowledges all alarms in the specified group	Acknowledges all alarms
Acknowledge Alarms on Point	Acknowledges all alarms associated with the specified point	
Acknowledge Alarm	Acknowledges specific alarm	
Disable All Alarms	Disables all alarms	
Disable Alarms on Group	Disables all alarms in the specified group	
Disable Alarms on Point	Disables all alarms associated with the specified point	
Disable Alarm	Disables a specific alarm	

Further selection boxes allow a group or point, respectively, to be defined.

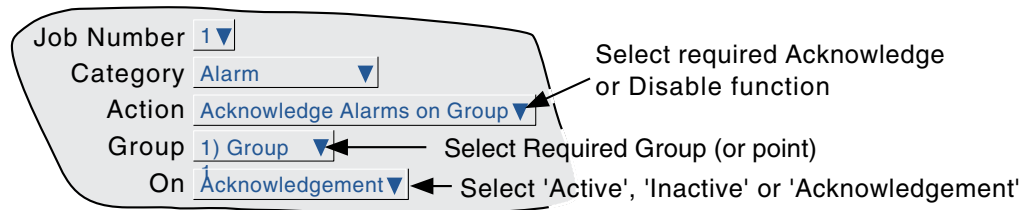

Figure 4.7.14 Alarm job menu layout

4.7.15 Archive category

Archive jobs allow a job to be used to trigger an archive to the instrument's mass storage medium or to a host computer using FTP/(S)FTP transfer. The following jobs are available:

Archive Last Hour, Last Day, Last 7 Days or Last 31 days to FTP/(S)FTP

Bring FTP/(S)FTP archive up to date

Cancel Archive to FTP/(S)FTP

Archive Last Hour, Last Day, Last 7 Days or Last 31 days to Local device

Bring Media Archive up to date

Suspend Archive to Media

Cancel Archive to Media

These jobs copy the archiving functions available from the 'Archive' key described in section 4.1 of this document. For 'FTP' items see ['Remote archiving'](#); for 'Media' see ['Local Archive'](#).

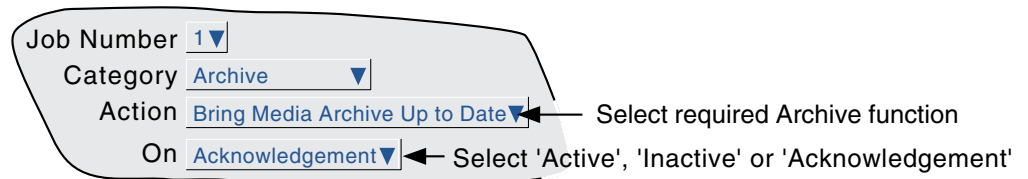

Figure 4.7.15 Archive jobs menu layout

4.7.16 Email category

Allows the user to send a specified e-mail to the recipients set up in e-mail configuration (see [section 4.3.19](#)). A system message is generated, and displayed in all recording groups whenever an e-mail is sent.

4.7.17 Report category

The screenshot shows a job menu for the Report category. It contains five dropdown menus with the following values and annotations:

- Category:** Report
- Send Report to:** Group (Annotation: ← Select 'Group' or printer (if fitted))
- Group:** 3) Furnace 3 (Annotation: ← If destination = 'Group', select destination group.)
- Report:** 2) Current temps (Annotation: ← Select the report to be sent)
- On:** Active (Annotation: ← Select 'Active', Inactive or 'Acknowledgement'.)

Figure 4.7.17 Report category job menu

SEND REPORT TO

Allows the user to select 'Group' or an ASCII printer (if fitted - requires Serial Comms. option) as the report destination. If 'Group' is selected (as in the figure above), a further field appears allowing the user to specify the group to which the report is to be sent (Group 3 in the figure above). If a printer is selected, the report is sent to the printer.

GROUP

This field appears only if 'Group' has been selected as the report destination, and allows the destination group to be defined. If a group descriptor has been entered ('Furnace 3' in the figure above), then this descriptor appears in the field.

REPORT

This defines which of the reports is to be sent when the job is triggered. If a Report descriptor has been entered, then this appears in the field ('Current temps' in the figure above).

4.8 SECURE FILE TRANSFER PROTOCOL (SFTP)

4.8.1 Overview

SFTP provides secure file and data transfer as it encrypts both the data being transferred and the authentication information.

From version 5.8 the 6000 recorder is supplied with SFTP enabled by default and will require configuring at installation, or disabling. Once configured the recorder and associated connected hardware and applications will communicate using SFTP.

Any connection to transfer data or a command, to and from the recorder will have to use SFTP and be preconfigured.

OPERATION

The Secure FTP function uses the Secure Shell Protocol (SSH) to create a secure connection between the server and a client, or multiple clients on various computers. See ["Figure 4.8a Secure FTP - Recorder 1, as a server" on page 248](#).

The secure connection is formed from the SSH protocol using Private and Public encryption keys, these produce the security by enforcing strong user authentication, as well as encrypting all data transferred. Both, command and data communications are encrypted between the client and the server, allowing passwords and other sensitive information to be transferred securely over the network.

With SFTP enabled, each recorder can generate and apply their encryption keys. The Private and Public keys should be considered a 'unique pair' that work together. The Private key is a hidden file on the recorder, but works in conjunction with the Public key.

The Public key is copied by a 'privileged' user, exported from the recorder and imported into the applications that connect to the recorder, for example Bridge, Reviewer or Security Manager.

The following helps provide security and authentication;

- Only a trusted, privileged staff member e.g. a System Administrator or Engineer should be responsible for the Public key Export/Import commissioning task, when adding a recorder or configuring applications that require a connection to a SFTP enabled recorder, see ["4.8.2 SFTP Commissioning Tasks" on page 251](#) for further details
- Each time an application initiates a SFTP connection to the recorder, a copy of the Public key is sent to validate the imported public key in the connecting application - if the public keys are identical - a secure connection is established, allowing the user to log on using their user credentials e.g. (User name and Password) which are sent securely
- If the public keys do not validate, the connection is refused and a warning will appear
- Once the user credentials are validated and accepted file requests and data transfer can be completed, securely.

CONFIGURATION

The recorder can be installed in multiple ways, the main principle that determines the SFTP configuration requirements is if the recorder functions as a server or as a client.

RECORDER AS A SERVER

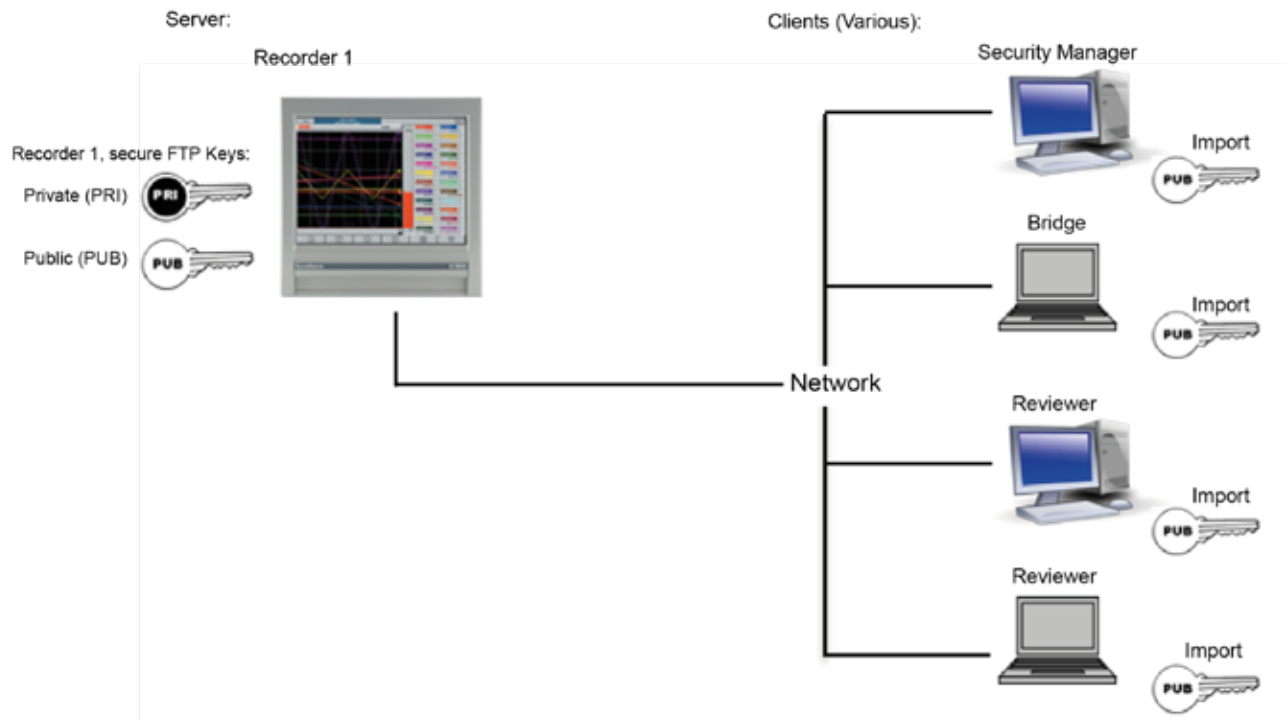

Figure 4.8a Secure FTP - Recorder 1, as a server

The recorder is installed in the conventional manner, see ["Figure 4.8a Secure FTP - Recorder 1, as a server" on page 248](#). Applications (software clients) that require a connection and communication with the recorder will require SFTP configuration.

The following briefly describes the SFTP configuration for applications (e.g. Bridge, Security Manager or Reviewer) connecting to a recorder running SFTP;

- Obtain, request or export a copy of the recorders current SFTP public key, if the existing recorder is operating over SFTP, see ["Export Public key" on page 251](#)
- If the recorder is being added to the infrastructure for the first time, generate new SFTP keys, see ["SFTP Key Pair - Generate" on page 251](#)
- Audit and control SFTP key usage. For example, record timestamps, key file names, generation date and distributed users
- Verify SFTP configuration now connects, by logging into the recorder using the recently SFTP configured application. Enter your user credentials where required and connect.

Note: If the SFTP configuration is incorrect, the connection is refused and a warning will display.

For further information regarding recorder SFTP configuration, see ["4.8.2 SFTP Commissioning Tasks" on page 251](#).

RECORDER AS A CLIENT

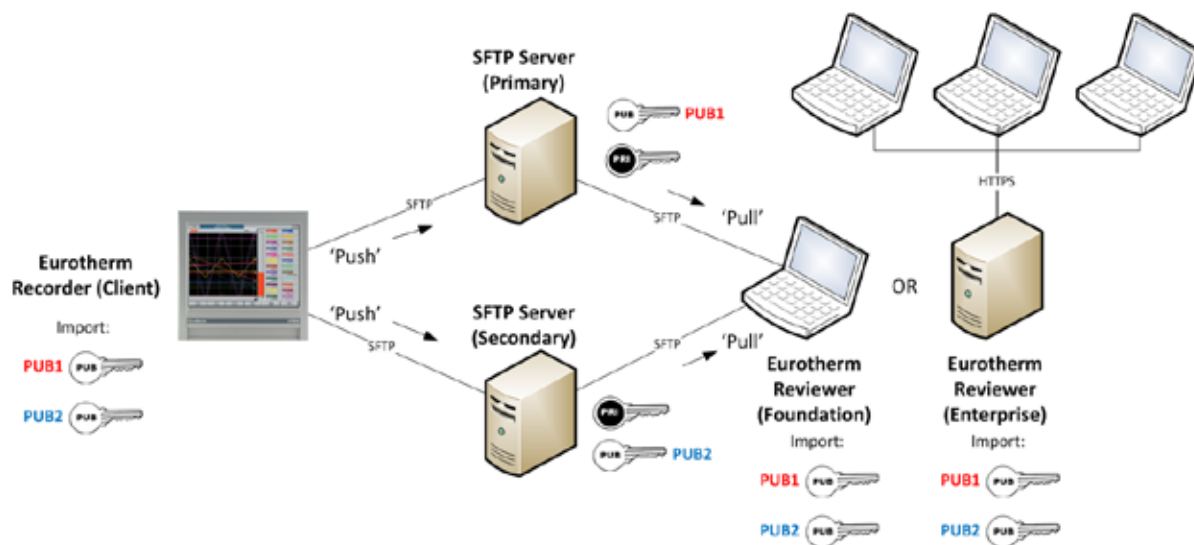

Figure 4.8b Secure FTP - Recorder as a Client

There are various system configurations, *Figure 4.8b Secure FTP - Recorder as a Client* displays a 6000 recorder as a client, connecting to two servers that are both running an SFTP server application.

The server referred to as 'primary' provides remote archiving and the system has been extended further by including a second server ('secondary'), to provide server redundancy for example, should the primary server go offline the recorder can archive to the secondary server.

In this example the recorder functions as a client, connecting to and transferring data to both the primary and secondary servers, so multiple SFTP configurations will be required. The below describes the required SFTP configurations:

1. Primarily the recorder must be SFTP configured as a client, with regard to the primary and secondary servers, the recorder 'pushes' data to both servers. Fundamentally the servers administer access.
2. The recorder may also have to support local applications, for example Bridge or Security Manager, then the recorder must also be SFTP configured as a server, in addition to the connecting applications to allow secure access.
3. A Firmware update server (not displayed in image) may also be utilized, to update the multiple recorders on large scale sites. (The firmware server utilizes a server SFTP application and administers access, by exporting a firmware server SFTP public key, which is then imported into any recorder requiring access to the firmware update server).

Multiple SFTP Configurations

The following briefly outlines the SFTP configuration requirements, when configuring a connection to a server and/or an application (software client) that is connecting to a recorder.

Recorder, connecting to a server

The following briefly describes the SFTP configuration, when connecting a recorder to a server;

Note: Servers that will interact and connect with any SFTP enabled recorder will require operational SFTP capability.

- Export, or request a copy of the servers current SFTP public key. If connecting to multiple servers, the public key will be required from each server. (See *PUB1* and *PUB2* public keys, in ["Figure 4.8b Secure FTP - Recorder as a Client" on page 249](#))
- If the server is new, or the server SFTP application being initially installed, you may have to generate new Server SFTP keys, see ["SFTP Key Pair - Generate" on page 251](#)

Note: Please consult your System Administrator who should be able to assist with completing the server SFTP configuration.

- Optional, audit the SFTP key usage, for example record timestamps, key file names, generation dates and distributed users
- Import the server SFTP public key, (one per server) into each recorder, for further information see ["Import Public key" on page 252](#)

Note: The recorder will advise on import if the public key is not suitable, for example; corrupt, incorrect file or key format.

- Verify SFTP configuration, and general connection by reviewing the server and observe files are being transferred and archived, from each SFTP configured recorder.

Recorder, connecting applications

The following briefly describes the SFTP configuration, for applications (e.g. Bridge, Security Manager or Reviewer) connecting to a recorder running SFTP;

- Obtain, request or export a copy of the recorders current SFTP public key, if the existing recorder is operating over SFTP, see ["Export Public key" on page 251](#)
- If the recorder is being added to the infrastructure for the first time, generate new SFTP keys, see ["SFTP Key Pair - Generate" on page 251](#)
- Audit and control SFTP key usage for example, record timestamps, key file names, generation date and distributed users
- Verify SFTP configuration now connects, by logging into the recorder using the recently SFTP configured application. Enter your user credentials, where required and connect.

Note: If the SFTP configuration is incorrect, the connection is refused and a warning will display.

For further information regarding recorder SFTP configuration, see ["4.8.2 SFTP Commissioning Tasks" on page 251](#).

4.8.2 SFTP Commissioning Tasks

Commissioning refers to the process and procedures that should be applied when introducing, adding, configuring and verifying a change to the system infrastructure. For example the installation of new components (e.g. a recorder), or a change to process e.g. SFTP.

The following information describes the typical 'commissioning tasks' expected when enabling and configuring SFTP, which should aid and simplify the overall SFTP configuration process.

Further information, such as SFTP recorder menus and options can be displayed by using the hyperlinks.

SFTP ENABLE

Refers to a recorder (or application or server) that has been enabled and configured to transfer files using the SFTP instead of the previous default option FTP. When SFTP is disabled, the recorder will default to FTP.

For further information and menu location of the option, see [SFTP ENABLE on page 251](#).

SFTP KEY PAIR - GENERATE

It is possible to generate new recorder SFTP keys, both the Public and Private. Typical examples of when the keys would be generated are during commissioning, re-commissioning a used recorder or if security has been compromised.

For further information and menu location of the option, see ["SFTP Key Pair - Generate" on page 56](#)

Note: When generating new SFTP keys beware the previous keys will be replaced, making any existing SFTP configurations out of date and unserviceable for the recorder and any configured applications (e.g. Bridge, Security Manager and Reviewer). All connections will require updating.

EXPORT PUBLIC KEY

A method of accessing and copying the SFTP public key, that will be used to configure SFTP connections.

FROM A RECORDER

It is possible to export a copy of the recorder's SFTP Public key, to use when configuring other SFTP connections, for local applications that require connections to the recorder.

For further information and menu location of the option, see ["SFTP Public Key - Export" on page 61](#)

FROM A SERVER

Details of how to export server SFTP keys are outside the scope and responsibility of this user guide, as there are many various version of server and server SFTP applications.

Note: Please consult your System Administrator who should be able to assist with completing the server SFTP configuration.

IMPORT PUBLIC KEY

There are multiple ways to import a public key, as SFTP public keys can originate from various locations and be associated to differing data sources e.g. server, primary or secondary. The following should help explain and separate the various options and required tasks.

INTO A RECORDER

The Import Public key menu enables the user to import a SFTP Public key from an SFTP configured server. An example could be a recorder connected to and uploading, transferring data securely to an archive 'primary' server (or multiple servers), see "[Figure 4.8b Secure FTP - Recorder as a Client](#)" on page 249.

For further information and menu location of the option, see "[Secure FTP \(SFTP\) Public Key - Import](#)" on page 58

INTO APPLICATIONS (SOFTWARE CLIENTS)

The recorder's SFTP Public key must be imported into the listed applications, to configure the SFTP connection. Listed below are applications that will require SFTP configuration;

Bridge - a remote viewing application that connects to the 6000 recorder, see [6 BRIDGE \(REMOTE VIEWER\) on page 256](#).

For further information see [Bridge SFTP configuration on page 260](#).

Security Manager - a centralized security system where User names, Passwords, Access permissions, Security Zone and Items can be managed. Please refer to the support documentation, starting with the Security Manager User Guide (HA028131), at www.eurotherm.com/en/eurotherm-downloads/.

Eurotherm Data Reviewer - an application designed for the viewing, analysis and printing of historical data files acquired from Eurotherm data acquisition equipment. Please refer to applications Help if installed or the support documentation at www.eurotherm.com/en/eurotherm-downloads/.

5 FILE

Figure 5, below, gives an overview of the File Menus. The area is entered by touching the 'File' key of the root menu, and can be used to display the contents of directories stored both in the user area of flash memory and on any bulk storage device inserted or connected.

The first display page shows the 'volume' or 'device' names associated with the various areas of memory available to the user. If one of these volume names is selected (touched), and the 'open-folder' key* operated, the contents of the selected volume is displayed. This would typically consist of a list of folders. Similarly, if a folder name is selected and the 'open folder' key* is touched, the contents of the folder is displayed and so on.

To return to higher levels, the 'close-folder' key* is used.

The path name of the current window is shown at the top of the window.

*Note: The open-folder and close-folder key functions are the same as the down arrow and up arrow key functions respectively.

5.1 FILER OPTION MENU KEYS

These keys appear in a pop-up menu when the option key is pressed. This menu appears only when an actual file has been selected (i.e. it does not appear if a directory (folder) or volume is selected.) Cut and paste functions are available only to users with the relevant access permissions ([section 4.4](#)).

Cut	Removes a file from the list, ready for 'pasting' to another destination.
Copy	Copies a file from the list, ready for 'pasting' to another destination.
Delete	Removes a file from the memory.
New	Allows a new directory (folder) to be created
Paste	Places a 'cut' or 'copy' file into the new destination.
Refresh	Refreshes the display.

A key's legend is hidden* if at any time its function is not applicable.

* i.e. displayed in the colour selected for 'Disabled Text' in the System key 'Customise' menu.

5.2 THE HIDE KEY

The Hide key at the top right corner of the display screen is used to hide (show) Type, Date and Bytes information, allowing the full filename text string to appear.

5 FILE (Cont.)

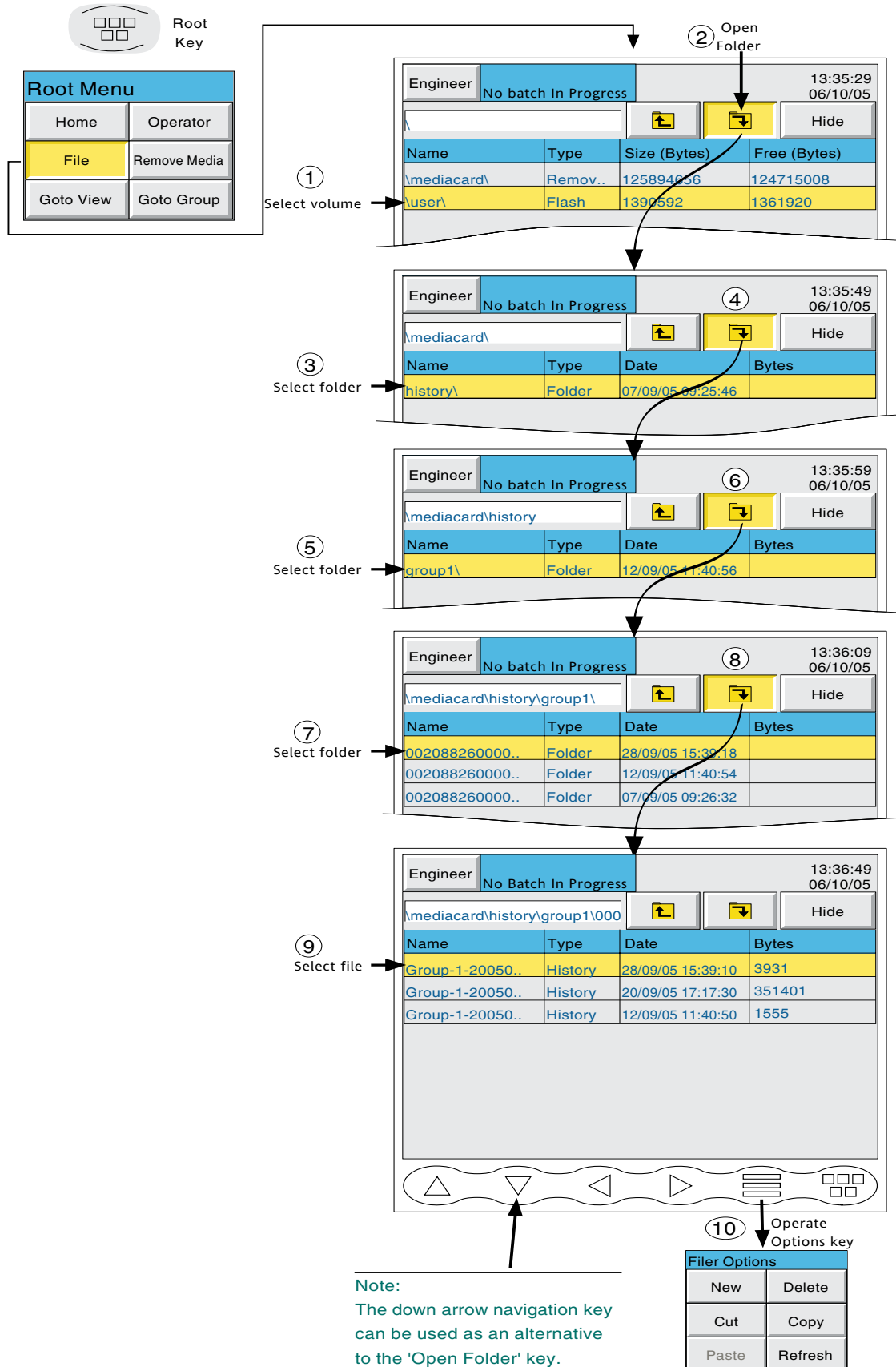

Figure 5 File system overview

5.3 FILE STRUCTURE

The file structure on the archive medium, is as depicted below in figure 5.3 for a six-group instrument. Each subdirectory contains a maximum of 32 files, there being sufficient subdirectories created, to contain all the group's history files.

The subfolder names are the numerical part of the first history file that they contain.

For example if the first file name is Furnace1 Temp~20080912 80155F2601000120.uhh, then the subdirectory name will be 20080912 80155F2601000120.

If there are more than 32 files, the next subdirectory name is 20080912 80155F2601000140 (assuming the file names are contiguous).

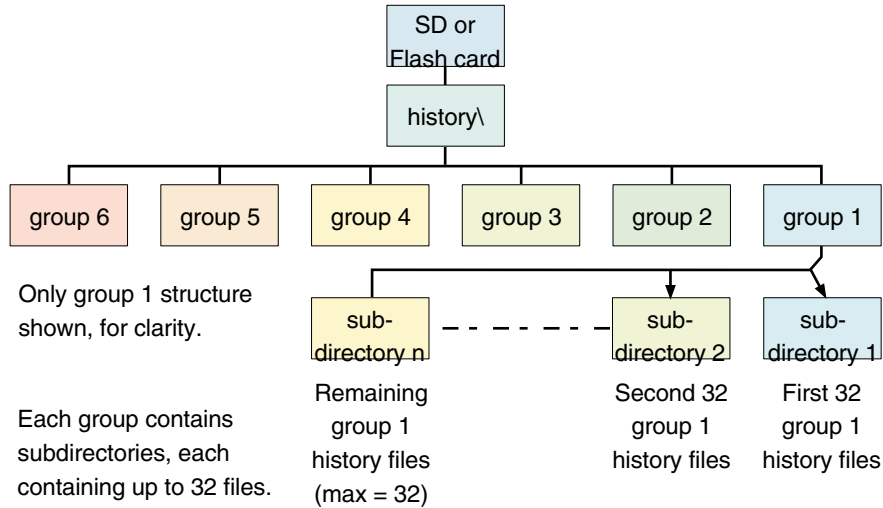

Figure 5.3 File structure (archive)

6 BRIDGE (REMOTE VIEWER)

6.1 INTRODUCTION

This feature comes in two levels, called 'Full' (option) and 'Lite' (supplied as standard).

The 'Full' option allows full operation and configuration of the recorder, simultaneously, from up to ten PCs which meet or exceed the minimum requirements listed below. When a change is being made to the configuration of the recorder by one Bridge user ('client'), the message:

```
Feature Locked
```

```
Another client (IP ADDRESS) has locked this feature.
```

```
Wait for lock to be released and try again
```

appears on the screen of any other user who attempts to change the configuration. When changes are complete, the message:

```
Feature changed
```

```
Synchronising data
```

appears on the screens of all clients (except that of the one making the change).

Bridge 'Lite' allows the user to view recorder standard screens, dynamically, on-line, from up to 10 PCs which meet or exceed the minimum requirements listed below.

The software is supplied on a CD ROM, which also includes PC Review, PC Configuration and Acrobat reader software and various manuals relevant to the recorder.

The Bridge software is suitable for any physical hardware configurations, some common examples being:

1. A single PC connected directly to a recorder.
2. Multiple PCs connected via a network to one or more recorders. (Each recorder can be accessed, simultaneously, by a maximum of 10 PCs, but one PC can look at only 'N' recorders where 'N' depends on how much memory is available at the PC. For example, a minimum specification computer ([section 6.1.1](#)) running Windows NT can 'look at' up to three recorders simultaneously.
3. A single PC connected via a telephone line to a remote recorder.

This manual does not describe network setup in detail, as each network is different. In most cases, the help of the network administrator or supervisor will be required, for example, in the allocation of valid addresses and passwords.

Notes:

- 1 When logging in via 'Bridge', only users with 'Connect from Remote' enabled appear in the user list. See [section 4.4.1](#) for details.
 - 2 Full Bridge requires some small amount of space on the PC disk. The message 'There appears to be no free disk space on the client. Create some space and run again.' appears if there is insufficient space.
 3. If an attempt is made to establish more than one Full Bridge connection between a PC and an instrument, the message "You are already running a Full Bridge session with this instrument. The new session will run as Bridge Lite." appears.
 4. If an attempt is made to establish a Full Bridge connection using the 'anonymous' user name, the following message appears:
'You are authenticating Full Bridge using the "anonymous" user name. This provides guest read only access. To establish Full Bridge connection you must use a different user name. Please change and try again.'
 5. The maximum number of Bridge sessions that can be run simultaneously on one recorder is 10.
-

6.1.1 Minimum PC requirements

1. Windows 10.
2. 32MB RAM.
3. 50MB free hard disk space.
4. Graphics drive capable of displaying > 256 colours (recommended).
5. Sound card required for audible alarms feature ([section 6.5](#)).

SUPPORTED PDA CONFIGURATION

PDA not supported this issue of software.

6.1.2 Software Installation Requirements

Listed below are the software installation requirements, which should be installed before installing the 6000 Series Tools.

Application	Requirement
6000 Series Tools	Microsoft Visual C++ 2015 Redistributable Update 3
- Security Manager	Microsoft .NET Framework 4.7
- Bridge	Microsoft .NET Framework 3.5

6.2 CONNECTION DETAILS

The connection to the recorder is terminated at the RJ45 connector located as shown in figures 2.2.1a, 2.2.1b). The other end of the cable may be terminated, for example, at a hub, a dial-up router or a PC, and it is up to the user to obtain a suitable cable (normally available from a computer supplier or electronic component distributor.)

Note: For direct connection between a PC and the recorder, a crossover cable is required. For all other connections, a 'straight-through' connection is required.

6.2.1 Direct PC connection

The RJ45 connector at the rear of the recorder is connected via a crossover cable to the PC network card connector.

6.2.2 PC To remote recorder

As shown in figure 6.2.2, one or more recorders' Ethernet connector can be connected to a Dial Up Router, plugged into a telephone socket. The PC must similarly be connected to a telephone socket via a modem (shown externally in the figure, but often built-in with modern computers.)

The dial-up router (available from computer suppliers etc.) has an associated telephone number, and can also have a security password system. Both the telephone number and any password(s) must be known to the PC user before any attempt at communication is made.

The PC can be set up to dial the number automatically, or the number may be dialled manually. Reference should be made to the computer documentation or help pages if necessary.

Once communication has been established, the software can be run.

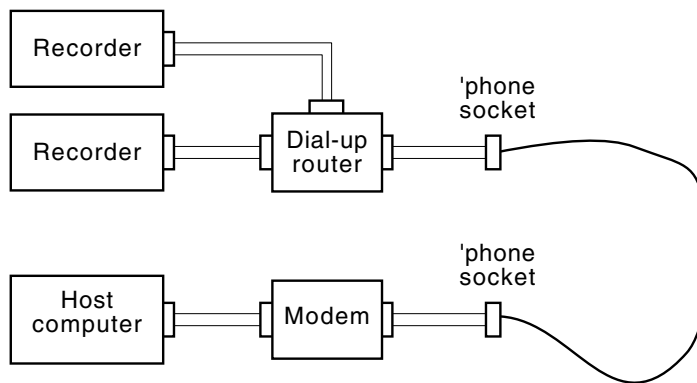

Figure 6.2.2 Remote connection example

6.2.3 Networked systems

For PCs and recorders connected into an internal network, it is necessary only to obtain an IP address (or name) and the required passwords in order to establish connections between the PC(s) and the recorder(s).

For PCs remote from a networked system which is permanently connected to the internet, it is necessary to obtain an IP address (or name) and the required passwords in order to establish connections between the PC and the recorder(s). In many cases it is also necessary that the internal network and 'firewall' (if such exists) be configured to allow access.

For PCs remote from a networked system which is not connected to the internet, a system similar to that shown in figure 6.2.2 is needed.

6.3 SOFTWARE INSTALLATION

Please refer to the CD box insert for details of software installation.

6.4 RECORDER CONFIGURATION

The recorder configuration is in three areas: Network, Options and Access.

6.4.1 Network

The Network key fields are fully described in [Section 4.5](#).

6.4.2 Options

In order to make the 'Full' option accessible, it must first be correctly entered in the Options Menu. If the Bridge level displayed does not match the 'currently' value (if displayed), operation of the 'Autoconfigure' key will add the option to the database.

If all options are correctly entered, the 'Currently' fields and the Autoconfigure key do not appear.

The screenshot shows the Options menu with the following fields and values:

- Trial Mode: Disabled
- Trial Time Remaining: 30 day(s)
- Fitted channels: 18
- Virtual channels: 36
- Maths: 12
- Totalisers: 12
- Counters: 7
- Groups: 12
- Batch: Enabled
- Security Manager: Disabled
- Auditor: 21CFR11
- Screen Builder: Full
- Bridge Level: Full
- Master Comms Devices: 32
- Simulation: Enabled
- AeroDAQ: Disabled
- EtherNet/IP: Enabled
- TUS: Enabled
- Relay Boards: 2 (currently /)
- Relays on Board 1: 3
- Relays on Board 2: 4 (currently 0)
- Event Input Boards: 1
- Analogue Output Boards: 1 (currently 0)

Buttons at the bottom: Apply, Discard, Autoconfigure.

Callout box text: Check that the Bridge level is correct. If not press 'Autoconfigure'.

Figure 6.4.2 Options menu

6.4.3 Access

Each of the access levels and user IDs can have 'Connect from Remote' access enabled. When this box is checked, password entry fields appear as shown in figure 6.4.3. Initially, the Remote User Name is the same as the login name or access level. Enter the required User name and password, then re-type the password to ensure it was entered correctly. This name and password are required when establishing connection with the host computer.

Notes:

1. If the Auditor 21CFR11 option is fitted, the minimum password length is that set in the Security/ Management menu described in section 4.4.2. For all recorders, the maximum password length is 20 characters.
2. For maximum security, it is recommended that the remote password and the local password be non-identical.

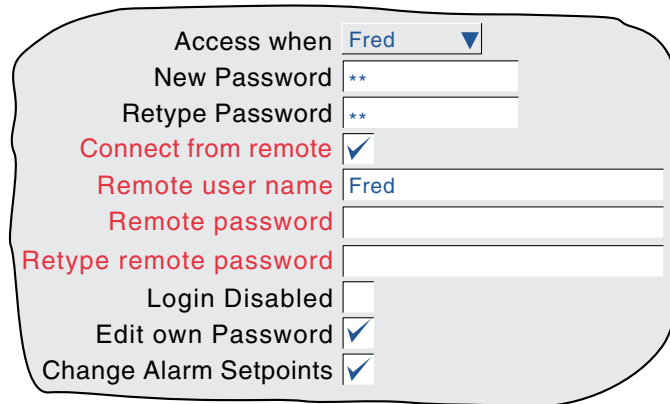

Access when	Fred
New Password	**
Retype Password	**
Connect from remote	<input checked="" type="checkbox"/>
Remote user name	Fred
Remote password	
Retype remote password	
Login Disabled	<input type="checkbox"/>
Edit own Password	<input checked="" type="checkbox"/>
Change Alarm Setpoints	<input checked="" type="checkbox"/>

Figure 6.4.3 Remote user access fields

Note: It is best practice to ensure that all bridge sessions are closed prior to any user password change on the device. Also, ensure all user levels have an associated password.

6.5 RUNNING THE PROGRAM

Initiate the program using the START button in the normal way.

Once the program starts, a Host name and User name will be requested as depicted in figure 6.5a.

Enter the Local host name (e.g. Andy136-4) found in the recorder Network/Name area, followed by a dot (full stop, period) followed by the domain name (e.g. FishesRus.co.uk) (also in the Network/Name area). These examples would result in an entry of Andy136-4.FishesRus.co.uk

Notes

- 1 If frequent use is to be made of this option, it is recommended that a 'short-cut' be created, and placed on the computer desktop. To create a new Bridge link: right click on the desktop, left click 'New' in the pop up menu which appears, then left click on the Bridge icon. When naming Bridge files, the extension .uhv must be used.
 - 2 If there is no DNS server associated with the system, the IP address (found in the recorder Network/Address area) should be used instead.
 3. The PC locale setting (e.g. Daylight Saving Time) must match that set in the recorder (System/Locale) or the displayed time will be incorrect.
 4. If an attempt is made to start the program whilst another user is configuring the recorder, a 'Feature Locked' message appears: 'Another client (instrument) has locked this feature. Retrying until successful' appears. As soon as the other client 'Saves' the new recorder configuration, this message disappears and the program continues its startup.
-

Enter the user name as entered in the recorder's Security/Access/Remote user name field ([section 6.4.3](#)).

If password entry is not required, disable the tick box (goes blank), then press 'Start' to start running the program

If a password entry is required, ensure that the password required tick box is enabled (tick visible). Press 'Start', then enter the password (as entered in the Security/Access/Remote User Name/Remote password field), followed by carriage return to start running the program.

Clicking 'Start as Lite', allows the user to select the 'View only' version of Bridge. This has the advantage of faster operation.

If the recorder utilizes Secure FTP (SFTP) as the preferred file transfer protocol for transferring data, the Bridge application will also have to use SFTP. To enable SFTP see [Bridge SFTP configuration on page 262260](#).

Note: If SFTP is not selected the Bridge configuration defaults to Passive FTP.



Figure 6.5a Profile (uhv file)



Figure 6.5b Bridge icon (approximation)

Bridge SFTP configuration

Should SFTP be required or already configured and operating on the recorder complete the following:

1. To enable the Secure FTP select and check the *SFTP* tick box on the Bridge Configuration panel. See [Figure 6.5a Profile \(uhv file\)](#) on page 261.

Upload Public Key

To authenticate the SFTP connection it is necessary to import the recorder's SFTP Public key, that you are connecting to. (Each recorder's SFTP Public is unique).

1. Ensure you have a copy of the recorders SFTP public key available for uploading. (For further information see [4.2.11 Export Public Key](#) on page 61).
2. Click the *Upload public key* button, navigate to the recorders stored SFTP public key location.
3. Select the SFTP public key file (.ssh), double click or click *Open*.

The Bridge Configuration panel will load and display the SFTP public key name.

Note: Should the file fail to load (for example, the wrong file type, format or corrupt), the panel will display *Bad public key selected*. To recover;

- Click the *Clear Key* button to delete the incorrect file from the *Bridge Configuration* panel
 - Repeat previous steps 2 and 3, ensure the correct SFTP public key is selected (.pub)
 - Should it advise *Bad public key* again, either the SFTP public key file format is incorrect or the file is corrupt
 - Generate new recorder SFTP keys, and restart the Upload Public Key process.
-

4. Click *Start* to complete the Bridge configuration using Secure FTP.

The Enter Password panel will appear, if you have enabled this option.

5. Enter the associated password with the configured user name and click *Enter* key on the PC's keyboard.

The Bridge application will appear and connect to the configured recorder in view only mode.

6. Click the *Logged out* button in the Bridge application, select a User profile from the *User ID* drop down menu and enter the associated password, and press *Enter* on the keyboard.

The Bridge application connects to the SFTP enabled recorder, with a verified logged in user.

Notes: It is best practice to:

1. Ensure that all Bridge sessions are closed before disabling the *SFTP enable* option at the device, should you want to return to FTP.
 2. Ensure that all Bridge sessions are closed prior to any user password change, on the device
 3. Ensure all user levels have an associated password.
-

CHANNEL ALARM SOUND

If the host PC is fitted with a sound card (enabled), bridge can cause sounds to be played on point alarm (not system alarms). The sound is selected on a connection-by-connection basis via the profile (uhv) file (see figure 6.5a). This allows each user to choose a sound (including none) suited to the local environment.

The sound runs for as long as any point alarm is active and unacknowledged.

Bridge software supplies a range of sounds as listed below. In addition, eight-bit, mono, μ Law-format .AU sound files can be imported to "<install location>\Series6000\startup\sounds". Once a sound has been imported, create or edit the profile (UHV) file. The new file should appear in the list. Select it and start.

The default sounds are:

1. Buzzer
2. Car Alarm
3. None
4. Police Siren
5. Siren, Fast
6. Siren, Slow
7. Something wrong
8. Train bell

6.6 OPERATION

6.6.1 Display Modes

When the program starts, the Home page, as set up in Configuration\Views ([section 4.3.4](#)) is displayed on the computer screen. By click-dragging on the bottom right hand corner of the display, the page size can be edited as required. It is thus possible for the computer to log on to, say four, different recorders and to display their values simultaneously in different parts of the screen.

The up/down arrow keys allow the enabled display modes to be cycled through and the root menu 'Goto View' menu allows a specific display mode to be chosen for the current group. The Home display page can be returned-to at any time, by operating the Root Menu key followed by the Home key.

Note: Any changes to the recorder's group configuration are reflected immediately at the Host PC's screen.

6.6.2 Alarm acknowledgement

The alarm acknowledgement/read messages functions are as described in [section 3.1.4](#).

6.6.3 Status line

The status line at the top of the screen reflects the status of the instrument to which the recorder is connected - e.g. system messages, global alarm, FTP/(S)FTP, clock etc.

6.6.4 Error messages

A number of error conditions may occur to prevent Bridge from 'viewing' the recorder. Such conditions result in the appearance of one of the pop-up messages listed below:

NETWORK CONNECTION HAS TIMED OUT

This message appears when no connection can be established between the host pc and the instrument. This might be caused by, for example, cable failure, the instrument's not being powered, network hardware failure etc.

UNABLE TO CONNECT TO HOST ...

Similar to the timeout message above, but with the additional cause: incorrect host address.

UNABLE TO RESOLVE HOSTNAME

Caused by an incorrect host address, or network failure.

FAILED TO AUTHENTICATE THE USER NAME ...

Caused by incorrect user name or password.

MAXIMUM NUMBER OF BRIDGE SESSIONS ALREADY RUNNING ON ...

An attempt is being made to establish more than the maximum number of Bridge sessions to the specified instrument.

THERE APPEARS TO BE NO FREE DISK SPACE ON ...

Appears if there is insufficient space on the PC hard disk.

YOU ARE ALREADY RUNNING A FULL BRIDGE SESSION ...

Appears if the pc is already connected to the recorder and running a Full Bridge session.

YOU ARE AUTHENTICATING FULL BRIDGE ...

Only Bridge 'Lite' is accessible to users using 'Anonymous'.

7 SCREEN BUILDER

7.1 INTRODUCTION

This option allows the user to create screen layouts using recorder data, simple drawing tools, text and/or imported image files.

24 user screens are editable directly from the operator interface. A further 100 extra screens (25 to 124) which can be created/edited etc. only via Bridge software are also available. Once created, such screens can be copied or moved to one or more of screens 1 to 24, thus becoming accessible at the instrument's operator interface.

Each enabled user screen appears as a selection key in the 'Goto View' menu. It is therefore recommended that the number of 'Bridge Screens' is set to the number actually needed, in order to reduce the number of 'More...' operations.

Notes:

1. User screens are not supported from a PDA.
 2. As a result of the way in which the screen is refreshed, unexpected results may be obtained if any component is superimposed upon an active component, such as a bargraph or trend display.
 3. The hash (#) key may not be used in text strings.
-

7.1.1 Display Access

As shown in figure 7.1.1, the user screens can be included in the display modes, described in [section 3.4](#), and a User screen can be selected as the 'Home page'.

Note: Circular Trend option displays are not supported in User screens with this release of software.

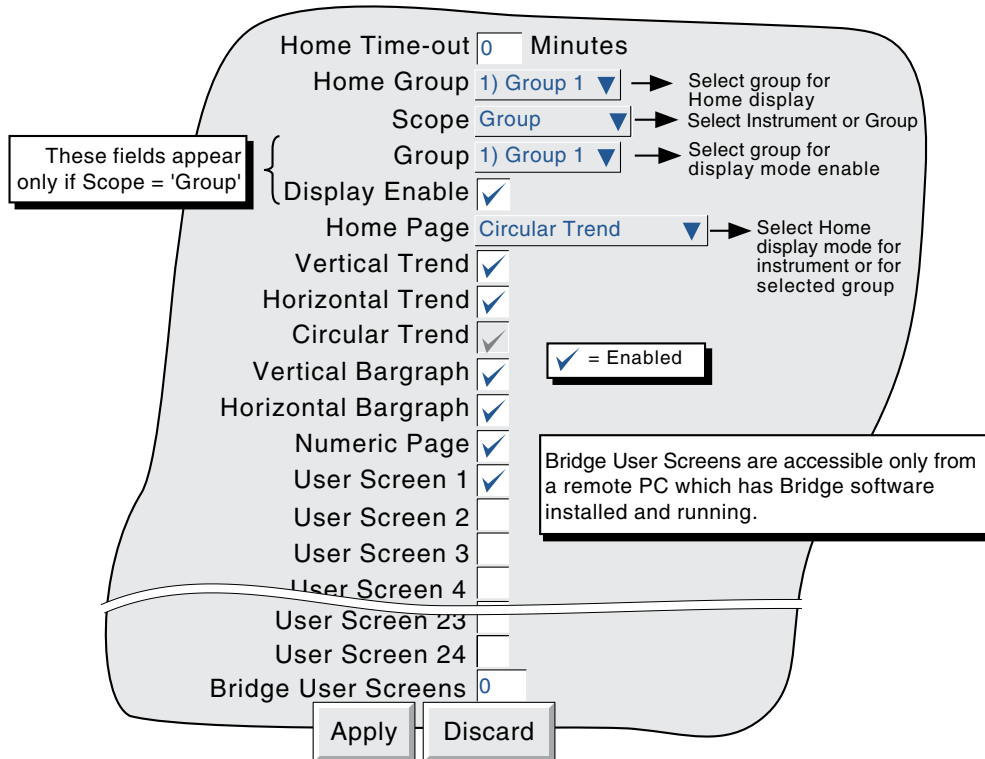

Figure 7.1 .1 Views configuration menu

7.1.2 Importing/Exporting screens

The Save/Restore screen (figure 7.1.2) includes the categories 'Import screen' and 'Export screen'.

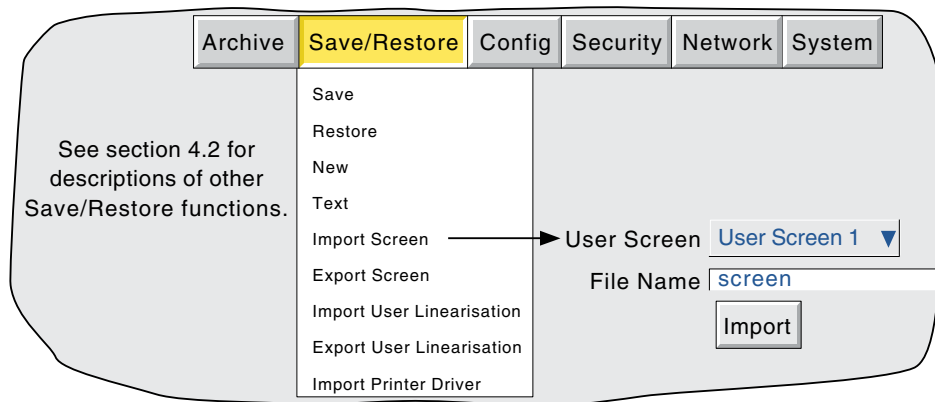

Figure 7.1.2 Save/Restore menu (Import screen)

7.1.2 IMPORTING/EXPORTING SCREENS (Cont.)

IMPORTING SCREENS

Touching the filename area, allows a previously created user screen to be selected either from the Flash memory or from disk to be imported. The User Screen picklist allows the user to define which User screen is to be 'replaced' by the imported file.

EXPORTING SCREENS

Allows user screens to be exported to Flash memory, or disk, The operator can assign a suitable filename before exporting.

7.2 DISPLAY CREATION

The following description is an attempt to show how to create a simple screen layout. The technique used is to define an object, then to specify its size, and where its top left corner is to be located on the screen.

The option offers two levels of sophistication - basic and advanced. The basic system defines size, position, fill colour etc. for components ([section 7.3.1](#)). Advanced parameters allow a more sophisticated fine-tuning of the appearance of the components

Note: X is horizontal, increasing rightwards. Y is vertical, increasing downwards. (Top left corner is 0,0)

As implied in figure 7.2.3a, screen component position and dimensions can be specified as percentage, absolute pixels or relative pixels. Percentage is 'percentage of screen size'. Absolute pixels allow position and/or dimensions to be defined as an absolute number of pixels. Relative pixels are the same as absolute pixels, except that if the display is rescaled on, say, a pc screen, the absolute pixel object will remain unchanged, whereas the relative pixel object will scale appropriately. Similarly, for transfer from an XGA screen recorder to a 1/4VGA recorder or vice-versa.

7.2.1 Before starting

Before starting to lay the screen out:

1. The user must have 'full configuration' access permission.
2. One or more user screens must be enabled in Views Configuration ([section 7.1.1](#))
3. A layout plan is produced, with all the required screen's components listed with their top left corner co-ordinates, their widths and heights, and where appropriate background and foreground colours.

7.2.2 Screen components

Table 7.2.2 shows the selectable screen components, their default top-left corner positions, widths/heights and draw order. All these components are described in [section 7.4](#) below.

Component	X	Y	Width	Height	Draw Order
Arc	0	0	10	10	10
Channel data	0	0	10	10	20
Channel horizontal bargraph	0	0	50	30	20
Channel numeric	0	0	50	20	20
Channel vertical bargraph	0	0	10	40	20
Dialogue action	0	0	10	10	10
Event Button	0	0	10	10	10
Group horizontal bargraph	0	0	50	50	30
Group horizontal trend	0	0	50	50	30
Group numeric	0	0	50	50	30
Group vertical bargraph	0	0	50	50	30
Group vertical trend	0	0	50	50	30
Image	0	0	10	10	10
Line	0	0	10	10	10
Main	0	0	100	100	1
Navigation action	0	0	10	10	10
Operator Button	0	0	10	10	10
Oval	0	0	10	10	10
Polygon	0	0	N/A	N/A	10
Polyline	0	0	N/A	N/A	10
Rectangle	0	0	10	10	10
Round rectangle	0	0	10	10	10
Text	0	0	0	0	20

Table 7.2.2 User screen selectable item default values

7.2.3 The properties page

1. Ensure that one or more user screens is enabled in views Configuration ([section 7.1.1](#)). If necessary, call the required User screen to the display using the Root menu 'Goto View' menu.
2. Press the Option key to call the Option Menu.
3. Press 'Edit Screen' to call the 'Component Property Editor' page to the display. This display contains the basic properties of the 'Main' (background) screen onto which the required components are to be overlaid.

Note: This may take some seconds, according to the complexity of the configuration

4. A further press of the Option key calls the user screen Options display page.
5. Use the Option key again to return to the Component Properties display. 5

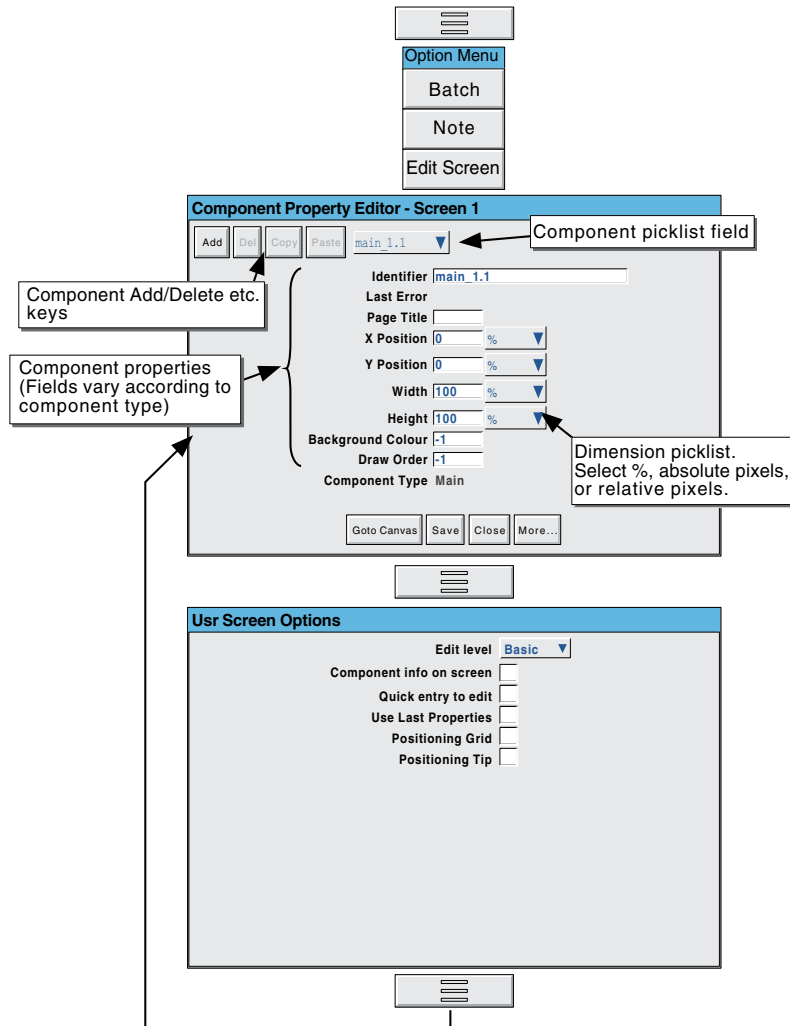

Figure 7.2.3a Component properties and User screen options pages

KEY DESCRIPTIONS (UPPER KEYS)

- Add Calls the Component selection list
- Del Deletes (after confirmation) the component in the Identifier field (except the Main pane which cannot be deleted).
- Copy Used to copy the current component to the pasteboard. 'Greyed' for 'Main' as this cannot be Copied.
- Paste Used to 'paste' the copied component to the screen. The copied item is placed 1% to the right of, and 1% below, the source component. 'Greyed' until a component Copy action has taken place.

7.2.3 THE PROPERTIES PAGE (Cont.)

KEY DESCRIPTIONS (LOWER KEYS)

Which keys appear at the bottom of the properties page depends on whether the user screen is being viewed at the recorder's user interface, or via Bridge software. Figure 7.2.3b show the recorder key arrangement; figure 7.2.3c the Bridge keys. The key descriptions below are in alphabetical order, rather than in left-right appearance order.

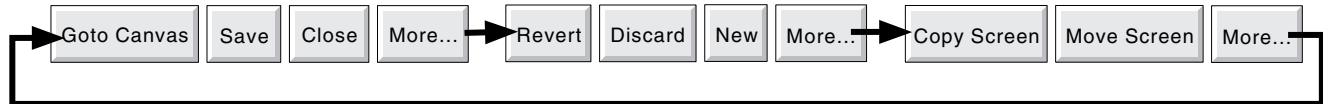

Figure 7.2.3b Recorder key arrangement

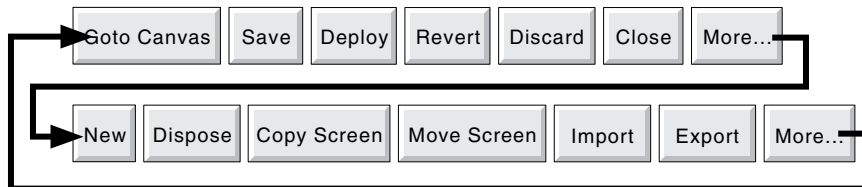

Figure 7.2.3c Key arrangement via Bridge

Close	Causes the screen to quit edit mode. If there are unsaved changes the user is asked for confirmation.
Copy Screen	Copies the contents of the current screen to another specified screen, leaving the current screen unchanged. If the destination screen is already in use, confirmation is required before the screen is overwritten.
Discard	Causes all changes made since the last 'Save' to be 'undone'
Dispose	This key appears only for users accessing user pages using Bridge software. When operated, it deletes the local version of the screen, so that the display reverts to the deployed version.
Deploy	This key appears only for users accessing user pages using Bridge software. It causes the screen to be saved to the PC database, and sent to the recorder.
Export	This key appears only for users accessing user pages using Bridge software. Calls a browser screen, allowing the user to select a path name to which to Export the current screen.
Goto Canvas	The Component Property Editor page disappears, and the screen is shown with the current component highlighted. Click and Drag techniques on the highlight 'handles' allow the component to be re-sized and its aspect ratio to be edited. Clicking and dragging within the highlighted area allows the component to be moved to any position on the screen. Selecting a component and touching the option key 'Goto Editor' key returns the user to the Component Property Editor with the selected component as the current component. (Using the Goto editor key without first highlighting a component re-opens the Component Property Editor with 'Main' as the current component.) When editing via Bridge, double clicking on a component returns to the Component Property Editor with that component as the current component.
Import	This key appears only for users accessing user pages using Bridge software. Calls a browser screen, allowing the user to select a User Screen for import.
More...	Calls next keyset.
Move Screen	Moves the contents of the current screen to another specified screen, leaving the current screen empty. If the destination screen is already in use, confirmation is required before the screen is overwritten.
New	Allows the creation of a new (blank) screen. Current screen components are deleted (after confirmation) leaving a blank screen. Items can be retrieved using the Revert key (above) prior to the next 'Save', 'Deploy' or 'Goto canvas'.
Revert	Causes all changes made since the last 'Goto canvas' operation to be 'undone'.
Save	Causes the current screen to be saved to flash or, for Bridge operation, to the PC database.

7.2.3 THE PROPERTIES PAGE (Cont.)

OPTIONS PAGE ITEMS

Edit level	Allows Basic or Advanced edit level to be selected for further use.
Component info on screen	Enabling this box causes a component description to appear at the top left corner of each component. This description is in the form: Identifier(X,Y)+[∂X,∂Y], where X and Y defines the top left corner position in pixels, and ∂X and ∂Y are the width and height of the component in pixels. The identifier is the component name as appears in the Identifier field of the Component Property Editor page.
Quick entry to edit	If selected, this function allows direct entry from the user screen being edited to the Component Property editor page, without the options menu first appearing offering the choice of 'Batch' or 'Edit Screen'. If Quick entry is selected, the option menu does not appear when the option key is touched. The Batch status page can be called by touching the 'Page Name' area at the top of the screen, as an alternative to the option menu. Quick entry has no effect on screens other than user screens.
Use Last properties	If selected, then all the common attributes (e.g. position, size, colours etc.) of the most recently edited object are applied to the next component to be added.
Positioning Grid	Causes a grid to appear on the 'Goto canvas' screen to help in component layout
Positioning tip	If enabled, then hovering over the highlighted item in a 'goto Canvas' screen causes the coordinates of the top left corner of the component to appear, in whatever units (% , pixels etc.) are selected for the component. The first number gives the 'X' (left-right) co-ordinate; the second gives the 'Y' (up-down) position. Clicking the left mouse key within a component causes the coordinates of the top left corner of the component to appear, in whatever units (% , pixels etc.) are selected for the component. Clicking the left mouse key outside a component, shows the co-ordinates of the mouse cursor tip. To see these co-ordinates within a component, the mouse must be click-dragged from outside the component.

7.2.4 Screen creation example

To produce a new display screen with channels one to four inclusive each displayed as an independent bar graph across the width of the screen, with Group 1 vertical trend display below. To achieve the above, the following items will be required:

1. Bar1: Horizontal bargraph with X = 0, Y = 0, Width = 100, Height = 10, channel = Channel 1
2. Bar2: Horizontal bargraph with X = 0, Y = 12, Width = 100, Height = 10, channel = Channel 2
3. Bar3: Horizontal bargraph with X = 0, Y = 24, Width = 100, Height = 10, channel = Channel 3
4. Bar4: Horizontal bargraph with X = 0, Y = 36, Width = 100, Height = 10, channel = Channel 4
5. Group 1: Vertical trend group with X = 25, Y = 48, Width = 50, Height = 50. Group name to appear above display.

PROCEDURE

1. Operate the 'Add' key to call the Component selection list.
2. Touch Channel Horizontal Bargraph to highlight it, then press 'Add'.
3. Repeat step 2 three times then
4. Touch 'Group Vertical Trend', then 'Add', then 'Close'
5. The Component property editor page reappears with the default values for the most recently added component displayed.
6. Touch the Identifier field, then enter the name 'Group 1' 'Ok' using the pop-up keyboard which appears.
7. In Group Number, select: 1) Group 1
8. Title bar is selected on (yes), as required
9. Enter the X (25%) and Y (48%) co-ordinates, using the same technique as was used for the Identifier field in step 6. The default dimensions (50 x 50%) are as required.
10. The Draw order is as required.
11. Press 'Save'

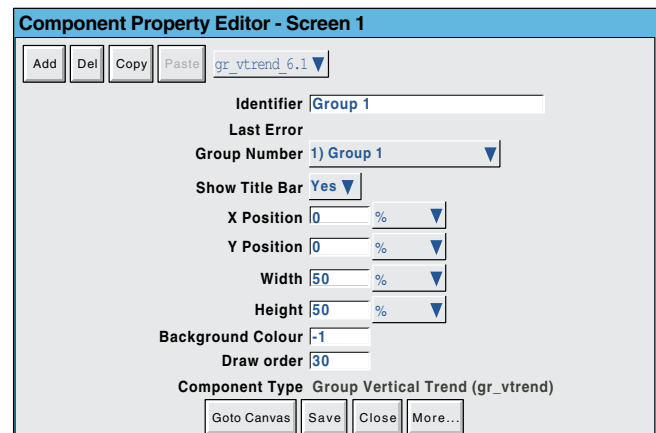
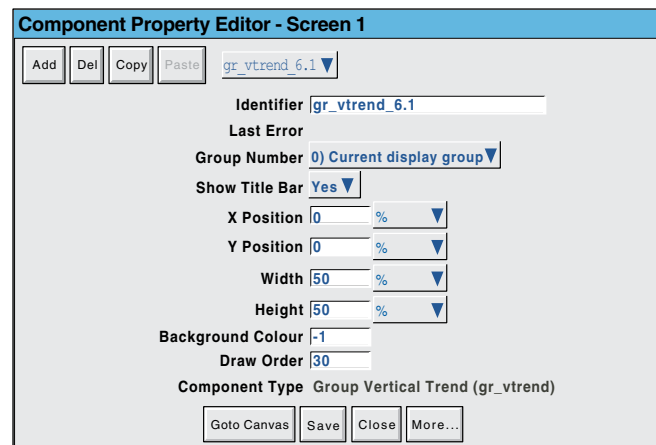
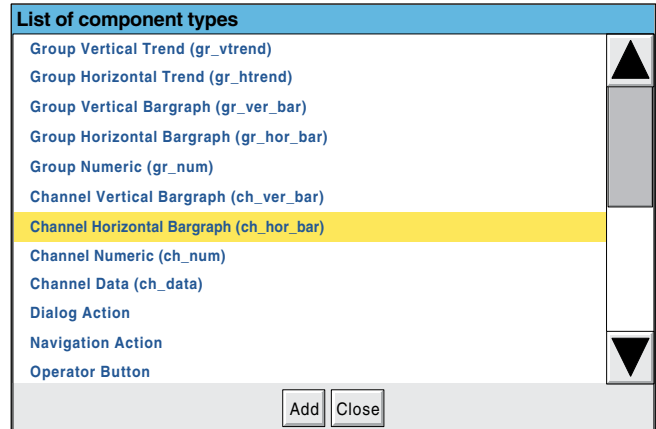

7.2.4 SCREEN CREATION EXAMPLE (Cont.)

12. Touch the component picklist field, and highlight the topmost ch_hor_bar... field.
13. In the Identifier field, enter the name 'Bar 1' using the pop-up keyboard. (To enter numbers, touch the 'Numeric' tab under the keyboard, then touch the required number.)
14. The channel number is as required
15. Touch the width field and enter a value of 100.
16. Touch the height field and enter '10'
17. Press 'Save'
18. Touch the component picklist field and select another bargraph.
19. In a similar way to that described for Bar 1
 - a) enter the identifier 'Bar 2'
 - b) select Channel 2 from the picklist
 - c) enter a Y value of 12
 - d) enter width = 100%; height = 10%.
20. Similarly configure Bar 3 and Bar 4, using the appropriate Y values (24 and 36) and Channel selection (3 and 4).
21. Finally, press 'Save', then 'Close', to reveal the display page.

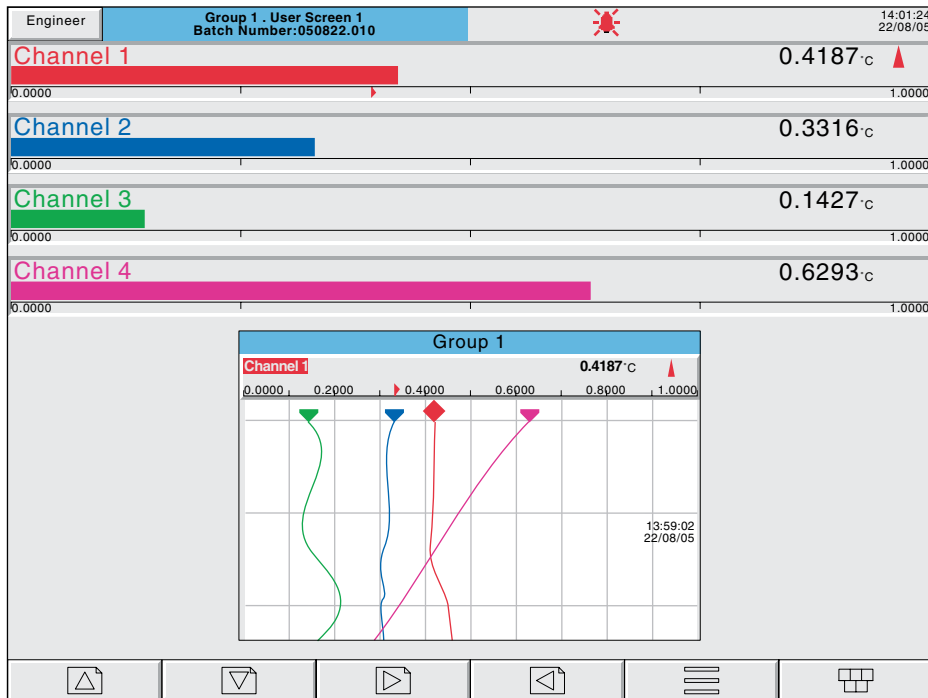
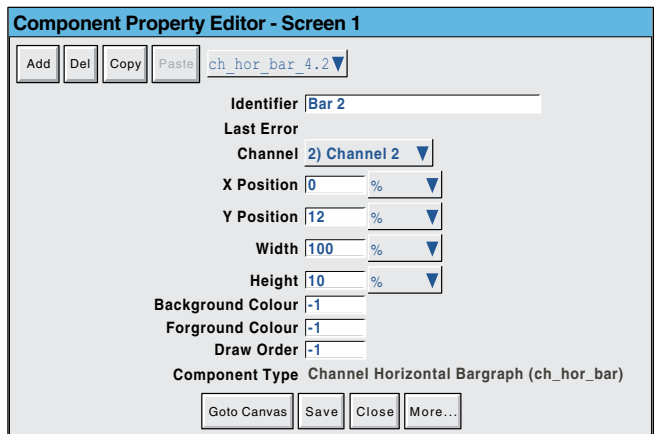
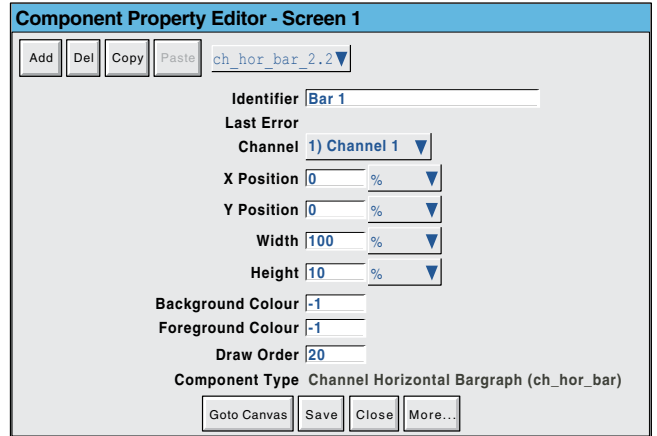

7.2.4 SCREEN CREATION PROCEDURE (Cont.)

In order to provide a degree of contrast, the background colour of the 'Main' page can be changed to a darker colour as shown for colour 22 in figure 7.2.3e, below. Figure 7.2.3f on the next page, shows the relevant component property pages.

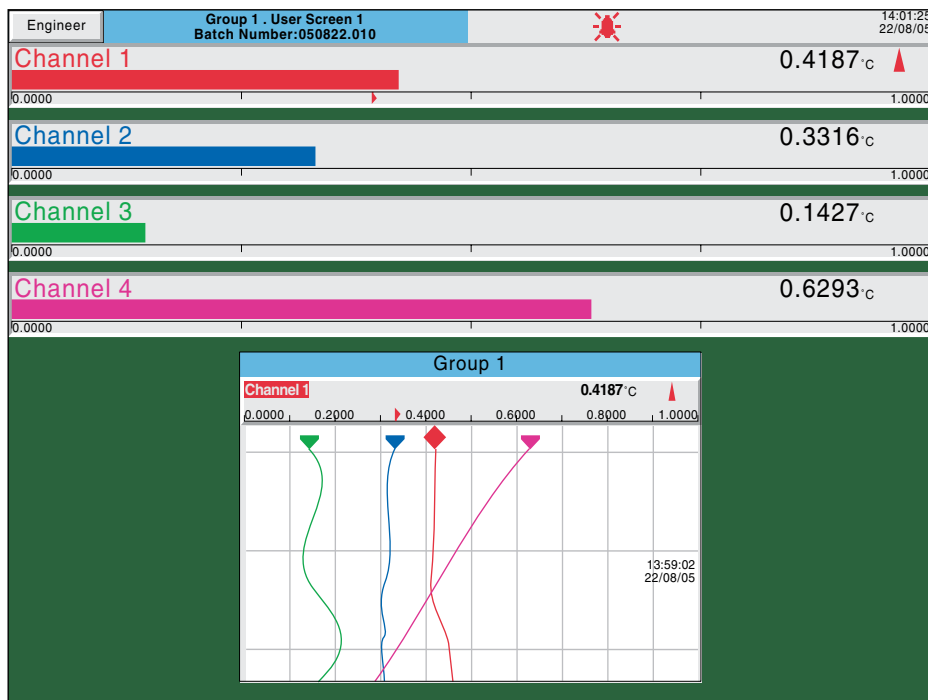

Figure 7.2.3e User screen example with coloured background.

7.2.4 SCREEN CREATION PROCEDURE (Cont.)

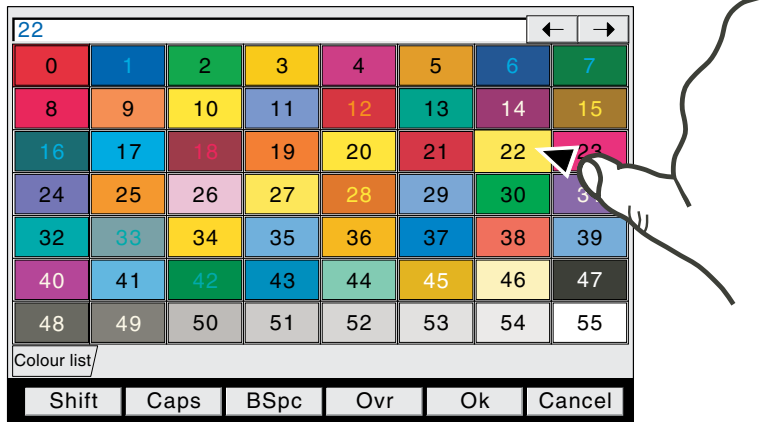
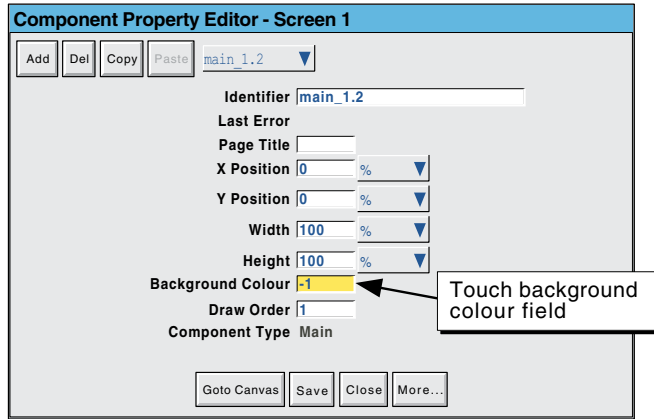

Figure 7.2.3f background colour selection pages

7.3 PARAMETER DEFINITIONS

The following parameters are associated with the components listed in [table 7.2.2](#), above. The list is divided into basic and advanced.

7.3.1 Basic parameters

Notes:

- 1 Not all components have all the following parameters associated with them. The component definitions in [section 7.4](#) define each component's parameters.
- 2 The generic term 'solid objects' as used in this description includes rectangles, lines, arcs, rounded rectangles, ovals, polygons and polylines. Lines and arcs do not have a background colour as they cannot be filled.
3. Default parameter units are in 'percentage of screen width/height'. The picklist next to each dimension field allows pixels to be used instead.

Parameter	Description
Arc Angle	For Arcs only, the number of degrees of arc drawn anti-clockwise (counter-clockwise) from the Start Angle. Negative angles draw clockwise. See figure 7.4.20a for definitions.
Arc Height	For Rounded Rectangles only, this is double the vertical distance from the corner of the (unrounded) rectangle at which the curve is to start. To draw 'circular' corners, this value must be 3/2 times the Arc Width. The Arc height value must be less than half the Rectangle height. Percent units are relative to the rectangle height, not the screen height.
Arc Width	For Rounded Rectangles only, this is double the horizontal distance from the corner of the (unrounded) rectangle at which the curve is to start. To draw 'circular' corners, this value must be 2/3 the Arc Height. The Arc width value must be less than half the Rectangle width. Percent units are relative to the rectangle width, not the screen width.
Background colour	The fill colour of solid objects; the background colour for the main page, trend charts, text messages etc. For Bargraphs, the colour 'behind' the bar.
Button Text	For operator buttons, Dialogue Action and Navigation Action. Allows button text to be entered. Event button text is defined in Event Button Configuration, described in section 4.3.7 .
Channel	Allows a channel to be selected for bargraph, numeric, value etc. display.
Draw edge	If set to 'Yes', this causes the outline shape of a solid object to be drawn in the foreground colour. If set to 'No', the object's outline is not drawn.
Draw Order	Allows a layer scheme to be introduced. Items with higher draw order values are overlaid on components with lower draw order values. The Draw Order feature is included specifically to allow a dynamic element (such as a bargraph) to be placed 'on top of' a background, static image. A dynamic element is always drawn on top all other elements at update time. When one or more dynamic elements are placed on top of one another, the results are unpredictable.
Edit Parameter	For operator buttons, allows the user to select the parameter type (e.g Channel N Alarm 1) to be edited when the button is operated. The parameter number (N) is entered in the 'N value' field.
Event Button	For Event buttons, this allows the user to assign an Event button to the User Screen Button to be displayed.
Feature	For 'Channel data' only, allows the type of data to be displayed (e.g. Current value), to be selected from a pick-list.
Fill Area	If set to 'Yes', this causes a solid object to be filled with the background colour. If set to 'No', the inside of the object is transparent. If 'draw edge' is also set to 'No', the object is invisible.

Table 7.3.1 Basic level parameters (sheet 1 of 2)

7.3.1 BASIC PARAMETERS (Cont.)

Parameter	Description
Foreground Colour	The line colour of solid objects. The bar colour of bargraphs (default = normal point colour). The colour of Text and of numeric values. Where applicable, this overrides channel colour.
Group number	Allows a group to be selected for group trend, bargraph and numeric displays, and for Dialogue action buttons. Select specific group, or '0' to follow current display group.
Height	Height of a component, measured downwards from the component's 'Y position'. Negative values measure upwards.
Identifier	Component name. Initially as in the Add Component list, but editable by the user.
Image File	Allows a file name to be entered when importing GIF or JPG images.
Last error	A text message describing the last error to occur for this component. The component must be re-edited in order to clear the problem.
N Value	See 'Edit parameter' above.
Page Title	Allows a name for the current user screen to be entered in 'Main'. This name appears at the top of the screen, and in the Screen number picklist for navigation action buttons.
Screen Number	For navigation action buttons, allows a screen to be selected. When the button is operated, the instrument will switch to the selected display screen.
Show Title Bar	When set to 'Yes', group displays (e.g. Group Vertical Trend) display a title bar across the top of the component, giving the selected group's descriptor. Selecting 'Show Title Bar' to 'No', removes the title bar from the display
Start Angle	For Arcs only, defines a start point for 'Arc Angle' above. See figure 2.4.20a for definitions.
Text	Allows a text string to be entered for display at the screen. The hash (#) key may not be used in text messages.
Width	The width of a component measured rightwards from the component's 'X position'. Negative values measure leftwards.
X points	Defines the X co-ordinates for polylines and polygons. Must match the number of Y-points for correct interpretation
X position	Distance between the left edge of the screen and the left edge of the component.
Y points	Defines the Y co-ordinates for polylines and polygons. Must match the number of X-points for correct interpretation
Y position	Distance between the top edge of the screen and the top edge of the component.

Table 7.3.1 Basic level parameters (sheet 2 of 2)

7.3.2 Advanced parameters

The selection of the Advanced properties set, is carried out from the Properties Options page as described in [section 7.2.3](#), above. Advanced properties are in addition to the basic properties described above, not a replacement for them.

Parameter	Pick list content	Description
3D effect	Enable/Disable	For Channel numeric display only, adds an embossed boxed surround to the display. Applies only if 'Custom' selected as Faceplate style.
Alarm marks colour	None	Allows a colour to be selected for alarm marks on trend scales. Default is colour 0 (red).
Bargraph style	Single Line... Faceplate below bar Just bar Bar and scale Default Default Vertical Bargraph System Vertical Bargraph Horizontal Bargraph	For horizontal bargraphs only. 'Plain' produces a bargraph with descriptor to the left of the bar, digital value to the right of the bar, and alarm indication to the right of the decimal value. 'With units' adds units after the digital value. '3D' adds an embossed boxed surround. 'Scale' adds a scale below the bar, with end-point values and tick points. Scale style (described below) may be used to modify the appearance of the scale. Produces coloured bar above channel descriptor, digital value and alarm indication. No scale is printed Produces a colour bar with no textual information, or just the low and high scale values, according to component. Produces a colour bar with a scale, but no digital value or alarm indication Produces a colour bar with scale, with descriptor, digital value and alarm indication above. Produces a colour bar with a scale Produces a colour bar with a scale Produces a colour bar with scale, with descriptor, digital value and alarm indication above.
Best Fit Font	Enabled/Disabled	For Channel numeric only. Applies only if 'Custom' selected as Faceplate style. If enabled, the display fonts for descriptor, value and units are selected by the instrument to suit the screen scale. The fonts will thus vary in size according to the size of the Channel Numeric display. Overridden by any settings for Value Font, Descriptor Font or Units Font other than 'Default'.
Channel cycle time	10	For group trend displays, allows a time period, in seconds, to be entered for channel scroll rate. 0 = no scroll.
Colour Alarms	None	Used only when Colour style = 'Channel alarms'. A semicolon-separated list of (Colour channel) alarms, used to change the colour of the component being configured according to alarm status. Colours are defined in 'Colour Backgrounds' and 'Colour Foregrounds', described below.
Colour Backgrounds	None	Used only if Colour style = 'Channel Alarms' or 'Channel thresholds'. A semicolon-separated list of background colours for the component being configured. The number of colours entered must match the number of alarms or threshold values as appropriate. Overrides any entry in 'Background Colour'. Colours are entered by touching each required selection in turn. The semicolon separators are entered automatically, in front of each selection (apart from the first).

Table 7.3.2 Advanced edit level parameters (sheet 1 of 6)

7.3.2 ADVANCED PARAMETERS (Cont.)

Parameter	Pick list content	Description
Colour channel	All channels	Allows a channel to be defined to be used in percentile or quartile filling or as a source of channel thresholds or channel alarms, as selected in 'Colour style', below.
Colour foregrounds	None	Used only if Colour style = 'Channel Alarms' or 'Channel thresholds'. A semicolon-separated list of foreground colours for the component being configured. The number of colours entered must match the number of alarms or threshold values as appropriate. Overrides any entry in 'Foreground Colour'. Colours are entered by touching each required selection in turn. The semicolon separators are entered automatically, in front of each selection (apart from the first).
Colour style	Channel thresholds	Allows a number of semicolon-separated values to be entered, to act as colour change triggers for the component being configured. The values are those of the source channel selected in 'Colour Channel' described above. The number of threshold values entered must match the number of colour values entered in Colour Foregrounds and Colour Backgrounds.
	Channel Alarms	Allows a number of semicolon-separated values (1 to 4) to be entered, to act as colour change triggers for the component being configured. These values represent alarms 1 to 4 of the source channel selected in 'Colour Channel' described above. The number of alarms entered must match the number of colour values entered in Colour Foregrounds and Colour Backgrounds. Point is displayed in the colour of the latest active alarm. For example: Alarms configured 1,2. Foreground colours configured 3;0 (amber and red). When alarm 1 goes active, the component goes amber. When alarm 2 goes active the component goes red. When alarm two clears, component reverts to Amber and so on.
	Background quartile	Background colour represents the value of the colour channel. Colour 0 appears for values below 25%, colour 1 for values between 25 and 50 %, colour 3 for values between 50 and 75% and colour 4 for values above 75 %. Foreground colour is default (-1).
	Foreground quartile	As background quartile but for the foreground colour. Background colour is default (-1).
	Background decimal	Background colour represents the value of the colour channel. Colour 0 appears for values below 10%, colour 1 for values between 10 and 20 %, colour 2 for values between 20 and 30% and so on up to colour 9. Foreground colour is default (-1).
	Foreground decimal	As background decimal but for the foreground colour. Background colour is default (-1).
Colour Thresholds	None	Used only when Colour style = 'Channel thresholds'. A semicolon-separated list of (Colour channel) values, used to change the colour of the component being configured according to the process value of the point selected in 'Colour Channel' described above. The number of threshold values entered must match the number of colours defined in 'Colour Backgrounds' and 'Colour Foregrounds', described above.
Decimal places	Default	Number of decimal places in Channel data display.

Table 7.3.2 Advanced edit level parameters (sheet 2 of 6)

7.3.2 ADVANCED PARAMETERS (Cont.)

Parameter	Pick list content	Description
Descriptor Font	Default	For Channel Numeric displays only, if Faceplate Style is set to 'Custom', then Descriptor Font allows the Channel Descriptor font to be selected from a picklist.
Display Alarms	Enable/Disable	For Channel Numeric displays only, if Faceplate Style is set to 'Custom', this selection determines whether or not alarm symbols are displayed in the top right hand corner of the display.
Display Bargraph	None	If selected, a vertical bargraph is drawn at the right hand edge of Horizontal Trend displays.
Display Descriptor	Enable/Disable	For Channel Numeric displays only, if Faceplate Style is set to 'Custom', this selection determines whether or not the channel descriptor appears at the top of the display.
Display messages	Enable/Disable	If selected, displays a message bar for Horizontal Trend displays.
Display Pens	Enable/Disable	If selected, pen representations appear at the top or right edge of a trend chart.
Display Units	Enable/Disable	For Channel Numeric displays only, if Faceplate Style is set to 'Custom', this selection determines whether or not the channel's units appear at the right edge of the display.
Faceplate Style	Default Just value No alarms Value and Units Single line Faceplate Custom	Produces a channel display with the descriptor and alarm indicators on the top line and with the digital value, and units on the bottom line. Shows only the channel value As default, but without alarm display Produces a larger digital display of the channel value, with units. As default, but all on a single line. The 'Display Descriptor', 'Display units' and 'Display Alarms' checkbox settings, and the font selections for Value, Units and Descriptor become active only if 'Custom' is selected as Faceplate style.
Faceplates Location	Dynamic, N, S, E, W	(Not available for group horizontal bargraph displays.) Allows the position of the faceplates to be 'dynamic' (appears at best position for the number of channels), or to be located above (North), below (South), to the right (East) or to the left (West) of the bargraphs. Also allows faceplates to be turned off altogether. For group trend displays, these faceplates are in addition to the current-channel faceplate, which always appears above the 'chart' across the full width of the display, unless turned off using Horizontal Faceplate disable.
Font style	List of fonts	Picklist holds a number of sizes, plain, bold and underlined bold.
Grid Line colour	Default	Allows a colour to be selected for trend chart gridlines
Horizontal Alignment	Left/centred/right	Allows text to be justified relative to its width setting
Horizontal Faceplate	Enable/Disable	For vertical trend displays, allows the current-channel faceplate to be selected on or off.
Horizontal Grid total	Default	Number of vertical divisions of a trend chart. If left at default uses the value entered in Group Configuration (section 4.3.2). Any other setting overrides Group Configuration entry.

Table 7.3.2 Advanced edit level parameters (sheet 3 of 6)

7.3.2 ADVANCED PARAMETERS (Cont.)

Parameter	Pick list content	Description
Horizontal Minor Divs	Default	Allows the user to enter a number of minor grid divisions. If left at default uses the value entered in Group Configuration (section 4.3.2). Any other setting overrides Group Configuration entry
Line thickness	1	Allows a pixel value to be entered for the line thickness of some components. It should be noted that the nature of the screen and of the drawing method means that curved lines of multi-pixel thickness can suffer from Moiré fringe, or interference effects.
Message Colour	Default	Allows a colour to be selected for messages on a trend chart
Minimum Height	Default	For individual channels within a group horizontal bargraph display
Minimum Width	Default	For individual channels within a group vertical bargraph display
Minor grid line colour		Default Allows a colour to be selected for trend chart minor gridlines
Nominal height	None	653 (503) = height of large frame (small frame) display area in pixels
Nominal width	None	1024 (934) = width of large frame (small frame) display area in pixels
Notes	None	Allows a note to be entered for the users convenience.
Number of Columns	None	Lays out group displays (other than trend) in the specified number of columns.
Number of Rows	None	Lays out group displays in the specified number of rows.
Numeric width	None	Number of characters in channel data display including decimal point.
On visibility change	Paint Background Paint All	Repaint the area of the component, including any text, in its background colour. If no background colour has been defined, the default (silver/grey) colour is used. Repaints the component area in the screen background colour thus rendering the component invisible.
PV Error Colour Background	Default	Allows a colour to be selected for background use when the relevant PV is in an error state. Overrides other selections.
PV Error Colour Foreground	Default	Allows a colour to be selected for foreground use when the relevant PV is in an error state. Overrides other selections
Reversed colour	None	Allows text to be displayed in the background colour against a background of foreground colour.
Scale Digits	None	For Horizontal trend displays. Allows the chart area to be maximised, by reducing the width of the vertical bar to the right of the chart. Scales will be presented in scientific format, or in 'N.?', 'N?' format etc. depending on the number of digits specified. The number of digits is in addition to the decimal point.
Scale Divisions - Major	None	For channel bargraphs, allows the number of major scale divisions to be specified for the channel. Overwrites the Scale Divisions-Major setting in the Channel's configuration.

Table 7.3.2 Advanced edit level parameters (sheet 4 of 6)

7.3.2 ADVANCED PARAMETERS (Cont.)

Parameter	Pick list content	Description
Scale Divisions - Minor	None	For channel bargraphs, allows the number of minor scale divisions to be specified for the channel. Overwrites the Scale Divisions-Minor setting in the Channel's configuration.
Scale style	Scale on bar--- No Text Decimal scale Default Horizontal Bargraph Horizontal Faceplate Vertical bargraph	See the figure below for clarification. For vertical bargraphs only. Produces scale tick marks, but without values For bargraphs, produces scale with 9 divisions (0, 10, 20, 30, 40, 50, 60, 70, 80, 90, 100% of scale width). Zero and full scale values printed. For Horizontal bargraphs, each scale division has 4 minor divisions (0, 20, 40, 60, 80, 100 % of major division). Uses scale information from each point's scale configuration As default for horizontal bargraphs Produces faceplate display with scale end points, descriptor, digital value and alarm indicator As default for vertical bargraphs.
<p>The examples below are alternatives - only one style can be chosen for each group bargraph display.</p>		
Show Alarm Marks	Yes/No	Allows channel scale alarm marks to be displayed (yes) or not (no). Alarm Marks Colour, described above, allows the user to select a colour for the alarm marks.
Time Marker colour	Default	Allows a colour to be selected for time/date printing on a trend chart
Time Marker interval	Default	Number of horizontal grid lines between successive time markers.
Trend Padding	Default	For group trend only. Normal trends are 1 pixel wide. Setting a padding value of N, adds N pixels on each side of the central pixel. For example, a padding value of 2 would produce traces 5 pixels wide. Applies to all channels in the group.
Units Font	List of fonts	For Channel Numeric displays only, if Faceplate Style is set to 'Custom', then Units Font allows the Channel Units font to be selected from a picklist.
Update when	Value changes Always	Action is taken when the value associated with the component changes The component is redrawn, continuously, at the display update rate.
Vertical alignment	Centred/bottom/top	Allows text to be positioned relative to its height setting
Value Font	List of fonts	For Channel Numeric displays only, if Faceplate Style is set to 'Custom', then Value Font allows the Channel Value font to be selected from a picklist.

Table 7.3.2 Advanced edit level parameters (sheet 5 of 6)

7.3.2 ADVANCED PARAMETERS (Cont.)

Parameter	Pick list content	Description
Vertical Grid Total	Default	Number of vertical divisions for trend chart. If left at default uses the value entered in Group Configuration (section 4.3.2). Any other setting overrides Group Configuration entry
Vertical Minor Divs	Default	Allows the user to enter a number of minor grid divisions. If left at default, the value entered in Group Configuration (section 4.3.2) is used. Any other setting overrides Group Configuration entry
Visible Alarm	Default	For 'When Visible' (below) is selected as 'In alarm or error' or 'not in alarm or error'. 'Visible Alarm' allows an alarm number to be entered, for use in determining whether a component be visible or invisible.
Visible Channel	All points	For use 'When Visible' (below) is selected as 'Channel Value', 'In alarm or error' or 'not in alarm or error'. 'Visible Channel' allows a point number to be selected from a pick list. See also Visible Operator, and Visible Value, below.
Visible Operator	List of operators	For 'When Visible' (below) is selected as 'Channel Value'. 'Visible Operator' allows a comparison operator to be selected from a picklist. The picklist contains the following items: Greater than, Less than, Greater than or equal to, Less than or equal to, Equal to, Not equal to. The comparison is made between the instantaneous value of the point selected in 'Visible Channel' and the value entered in 'Visible Value' (below). For example, when using the 'Greater than' operator, the component is visible whenever the Visible Channel's value is greater than the Visible Value.
Visible Value	Default	For 'When Visible' (below) is selected as 'Channel Value'. 'Visible Value' allows a value to be entered to be used in the 'Visible Operator' comparison described above.
When visible	Always Never Channel value In alarm or error Not in alarm or error	Component is always visible Component is never visible Component is visible or not, depending on the relationship between the current value of a selected channel and a specified constant value. See 'Visible channel', above, for details. Component is visible if a specified alarm on a specified point is active, or if the point is in an 'Error' state. See 'Visible Alarm', above, for details. Component is visible if a specified alarm on a specified point is not active, or the point is not in an 'Error' state. See 'Visible Alarm', above, for details.

Table 7.3.2 Advanced edit level parameters (sheet 6 of 6)

7.4 COMPONENT DEFINITIONS

This section defines all the available components listed in [table 7.2.2](#) in terms of their parameters. The components occur in the order in which they appear in the list.

7.4.1 Group Vertical/Horizontal Trend

This produces a display which mimics a recorder chart, for a selected group. All the functions (e.g. trend history) described in, [section 3.4](#). The following unique parameters (fully described in [table 7.3.2](#)) are available for configuration:

Background colour	Allows the 'chart' to be drawn in the selected colour.
Message Colour	The colour of messages printed on the 'Chart'.
Time Marker Colour	The colour of time/date printed on the 'Chart'.
Grid Line Colour	The colour of the 'Chart' grid lines.
Faceplates location	Allows 'group' faceplates to be enabled/disabled, and when enabled allows the position of the faceplates to be defined. These 'group' faceplates are additional to the current-channel faceplate which always appears above the chart, unless it has been disabled under 'Horizontal faceplate' (below).
Time Marker Interval	Selects the number of horizontal chart lines between successive time markers
Vertical Grid Total	Total number of vertical chart divisions.
Horizontal Grid Total	Total number of horizontal chart divisions.
Trend Padding	Sets thickness of traces.
Channel cycle time	Allows a number to be entered for the scrolling period between channels. 0 = Channel hold.
Display Messages	Allows message printing to be enabled/disabled.
Display Bargraph	For Horizontal trending only, allows the vertical bargraph display to be switched on and off.
Display Pens	Allows the pen icons at the edge of the chart to be switched on and off.
Horizontal Faceplate	Allows the current-channel faceplate to be switched on and off.

7.4.2 Group vertical bargraph

Produces a vertical bargraph for a selected group in a format defined by 'Bargraph Style' and 'Scale style' described in [table 7.3.2](#). The number of rows of bars can also be defined by the user, according to the overall size of the display, number of channels etc. The default value of zero means that the recorder will display what it 'believes' to be the most ergonomic number of rows.

The recorder attempts to fit as many channel bars as possible into the width of the display. The default minimum width of a column is 6 mm. If there are more channels than can be fitted into the display, a scroll bar device appears at the bottom edge to allow 'hidden' bars to be accessed.

The recorder attempts to fit as many faceplates as possible into the height of the display. If there are more faceplates than can be fitted into the display, a scroll bar device appears to allow 'hidden' faceplates to be accessed.

7.4.3 Group horizontal bargraph

Produces a group horizontal bargraph, for a selected group, in a format defined by 'Bargraph Style' and 'Scale style' described in [table 7.3.2](#). The number of columns can also be defined by the user, according to the overall size of the display, minimum width, number of channels etc.

The recorder attempts to fit as many channels as possible into the height of the display, according to the specified minimum height (default = 12mm). If there are more channels than can be fitted into the display, a scroll bar appears at the right edge to allow 'hidden' channels to be accessed.

7.4.4 Group numeric display

This produces a display of a selected group's numeric values, in one of a number of formats, as described in 'Faceplate Style' in [table 7.3.2](#) above. The number of columns can also be defined by the user, according to the overall size of the display, number of channels etc. The default value of zero means that the recorder will display what it 'believes' to be the most ergonomic number of columns.

The recorder attempts to fit as many channels as possible into the height of the display, according to the specified minimum height (default = 12mm.). If there are more channels than can be fitted into the display, a scroll bar appears at the right edge to allow 'hidden' channels to be accessed.

7.4.5 Channel vertical/horizontal bargraph

For a specified channel, this produces a dynamic horizontal or vertical bargraph display of channel value, in a format defined by 'Bargraph Style' and 'Scale style' described in [table 7.3.2](#)

7.4.6 Channel Numeric

For a specified channel, allows the channel faceplate to be displayed in one of a number of formats, as described in 'Faceplate Style' in [table 7.3.2](#) above.

7.4.7 Channel data

For a specified channel, allows one of : Current value, Descriptor, Units, Span low or Span high to be selected for display.

7.4.8 Dialogue Action

This displays a pushbutton which can have one of three actions assigned to it:

1. Call the Login page.
2. Call the Batch Status page
3. Call the Operator Note dialogue box.

For Batch and Operator Note use, a Group number can be selected.

7.4.9 Navigation Action

This displays a pushbutton, the purpose of which is to call a different display screen. A Group and a screen can both be specified, so this button provides a shortcut version of the 'Goto group' and 'Goto View' keys of the root menu.

7.4.10 Operator button

This displays a user pushbutton. The legend on the pushbutton, and the task it is to carry out, are defined in the button configuration. If the text is too long for the width of the button, the text is truncated (e.g. Reset Ave...). Possible tasks are as follows (assuming that the relevant options are fitted):

- 1 Edit the threshold (setpoint) setting for alarms 1 to 4 for point N
- 2 Reset Maths channel N
- 3 Edit Maths constant N
- 4 Preset Totaliser N
- 5 Preset Counter N
- 6 Start/Stop Timer N
- 7 Initiate Demand Write N
- 8 Set output channel N to default values.



Figure 7.4.10
Typical operator button

In all the above, N represents any number between 1 and the maximum number available for the relevant type of point. (Point is an umbrella term for an input channel, a maths channel, a totaliser, etc.)

When the button is operated a 'confirmation' page appears allowing, for example, the value of a constant to be edited before operating the 'Apply' button.

Notes:

- 1 If the point being accessed is not suitably configured, the 'confirmation' page is blank. For example, if the Operator button is configured to change, say, the threshold (SP) of Alarm 2 on Channel 6, and either Channel 6 is Configured 'Off', or alarm 2 is 'Off', then the Confirmation page will not have a configurable area allowing the user to enter the required new value.
2. Any signing or authorizing that normally applies to the item being edited, also applies when changes are being made by means of the Operator button.

7.4.11 Event Button

This displays a pushbutton, to be used as a source for an event. The button name, its action (latching or unlatching), and whether or not the operation of the button needs signing or authorizing are set up in Event Button configuration, described in [section 4.3.7](#). The actions taken when the button is operated are set up in Event configuration, described in [section 4.3.6](#). Signing and Authorizing are as described in [section 4.4.2](#) (Management).



Figure 7.4.11 Typical Event Button

7.4.12 Image

This allows a GIF (Gif87a format only) or JPG image file to be loaded from (e.g.) an SD or Flash card. Once this has been done, bargraphs, text messages etc. can be superimposed on the image.

Notes:

- 1 Only user screens 1 to 6, may have images embedded in them, and the size of each image may not exceed 250kB (see also note 3). Does not apply to Bridge-only screens (25 to 124).
2. It is recommended that 'abs_pxl' be selected as width and height units, before an image is loaded. The use of any other units significantly increases the time taken for the loading process to complete.
3. For user screens 1 to 6, the physical size of the image may not exceed 1024 pixels wide or 768 high. Any attempt to load an image larger than this results in a 'User Screen Image Error' message asking that the image size be reduced. The size constraint does not apply to Bridge-only screens (25 to 124).

7.4.13 Text

If width and height are left with the default values of zero, the text will start at the specified start point and fit in the space between there and the right edge of the screen, in a single line (left justified (ranged) as a default). If the text string is too long, it is truncated. The text appears in the specified foreground colour, superimposed on a 'box' of background colour which is the same width of the text string.

If width and height are defined, then the text will fill the defined width and any remaining text is truncated. The text appears in the foreground colour (default black), over a field of background colour (default grey).

Advanced properties allow the text to be set to range left, range right or be centred, at the top, bottom or centre of the field, and for the foreground and background colours to be swapped.

7.4.14 Round rectangle

Similar to a rectangle described in section 7.4.15, but offers the user the opportunity to draw rectangles with curved corners. The horizontal and vertical curve angles are specified separately, and the aspect ratio of the screen should be taken into account when working in percentage units.

Note: The rounded rectangle will draw incorrectly if either of the arc height/width settings are greater than half the rectangle height/width settings.

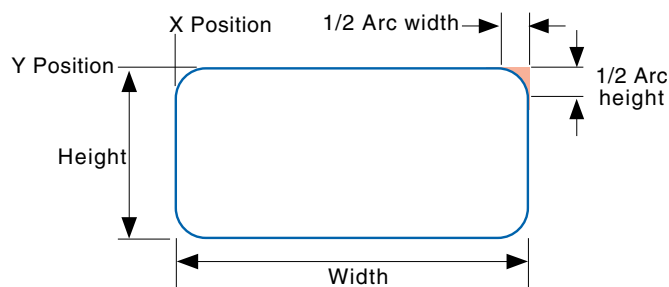

Figure 7.4.14 Round rectangle definitions

7.4.15 Rectangle

This draws a rectangle on the display page. If the height and width of the rectangle are defined in the default 'percentage units', then entering equal values for height and width will result in a rectangle with the same aspect ratio as that of the screen, not a square as might be expected. Because the screen height is approximately 2/3 the width, the rectangle height should be 3/2 the rectangle width to produce a square. (The actual height/width ratio is $535/800 = 0.669$ for large frame units or $214/320 = 0.669$ for small frame units).

Using pixels as the measuring units obviates this problem as pixels are square.

7.4.16 Polyline- series of points

Similar to closed polygons, described in section 7.4.17 below, but the first and last points are not automatically joined, and the drawn item cannot be filled and the line width cannot be specified - it is always one pixel.

Note: When working in percentage units, it should be remembered that vertical percentage units are only 2/3 the size of horizontal percentage units - this affecting the appearance of the drawn item.

Example: To draw an (old fashioned) electronic resistor icon (Units = Absolute pixels)

X position = 400, Y position = 236,

Foreground colour = 0

X points = 0,10,15,25,35,45,55,65,75,85,90,100

Y points = 0,0,-10,10,-10,10,-10,10,-10,10,0,0

Press 'Apply', then 'Close' to produce a red 'sawtooth' outline, as depicted in figure 7.4.16 below.

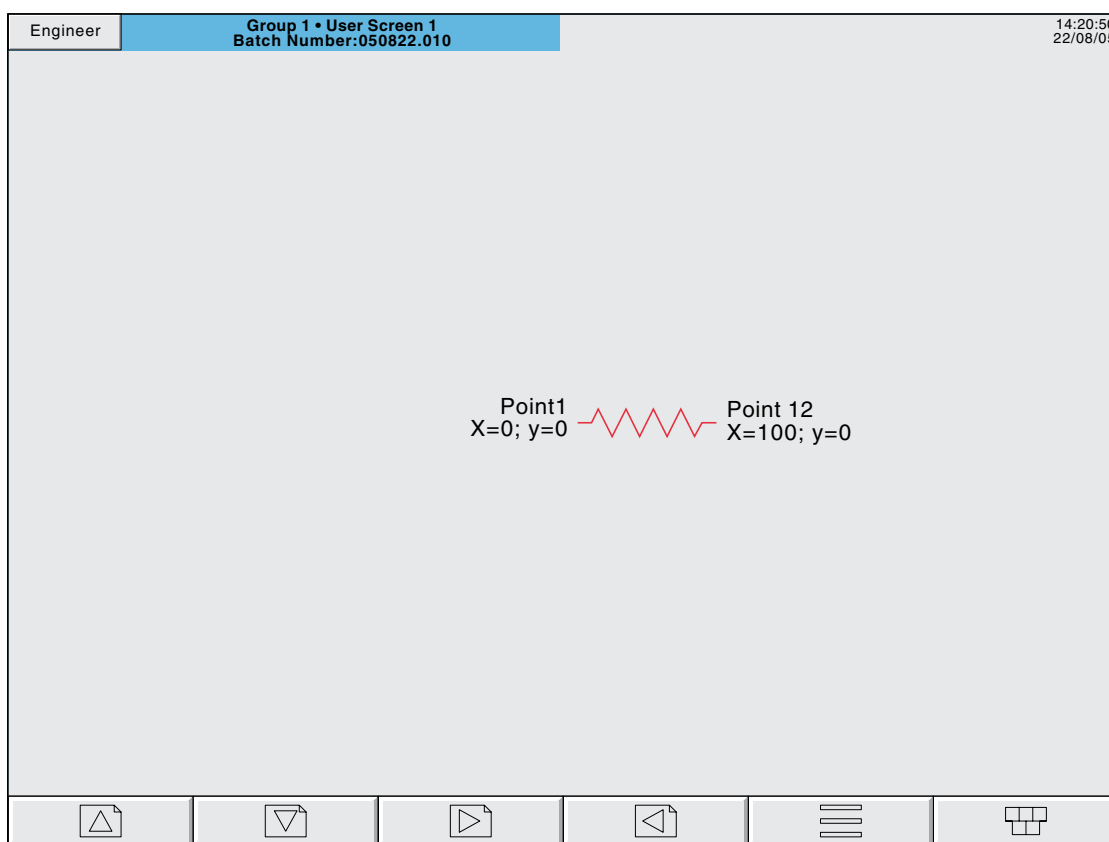

Figure 7.4.16 Polyline example

7.4.17 Polygon - closed area

This allows a number of pairs of points to be entered, which, if valid, will then be joined by straight lines. The first and last points are automatically joined, by the recorder. The shape, drawn in the specified foreground colour, with the specified line width, can be filled with the specified background colour.

Note: When working in percentage units, it should be remembered that vertical percentage units are only 2/3 the size of horizontal percentage units - this affecting the appearance of the drawn item

Example: To draw a left pointing solid arrow, positioned with its point at the centre of the screen.

Access the component page as described in [section 7.2.3](#), select 'polygon - closed area' and press Ok. In the properties page, carry out the following configuration (units = %):

X position = 50, Y position = 50,

Background colour = 22, Foreground colour = 30

Draw edge = Yes, Fill area = Yes

X points = 0,10,10,30,30,10,10

Y points = 0, -15, -5, -5, 5, 5, 15

Press Apply, then Close to produce a dark green arrow, with pale green outline, as depicted in figure 7.4.17 below.

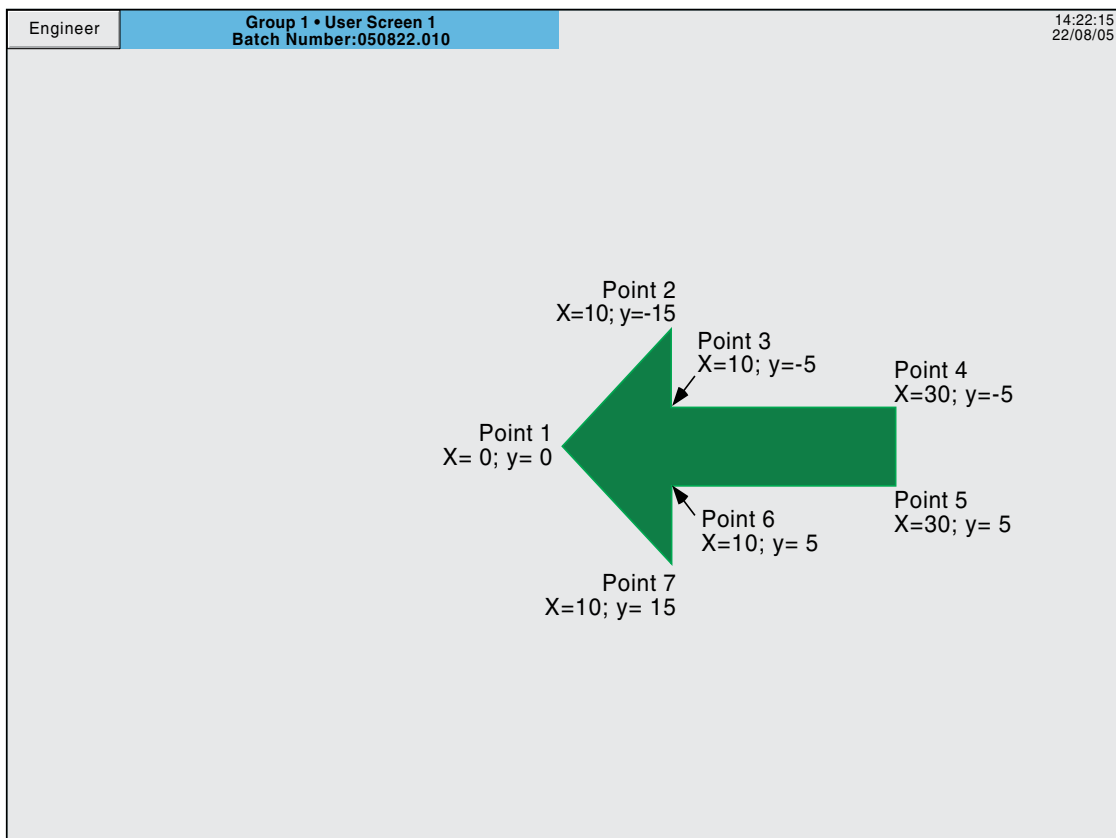

Figure 7.4.17 Polygon example

7.4.18 Oval

Similar to an arc (section 7.4.20) with an arc angle of 360 degrees, but arcs cannot be filled,

If the height and width of the oval are defined in the default 'percentage units', then entering equal values for height and width will result in an oval with the same aspect ratio as that of the screen, not a circle as might be expected. Because the screen height is approximately 2/3 the width, the oval height should be 3/2 its width to produce a circle. (The actual height/width ratio = 0.669).

7.4.19 Line

This causes a straight line of user-definable thickness to be drawn between the points (X position; Y position) and (X position + width; Y position + height)

Notes:

- 1 Y increases downwards; X increases rightwards
- 2 Height = 2/3 width if measuring in percent

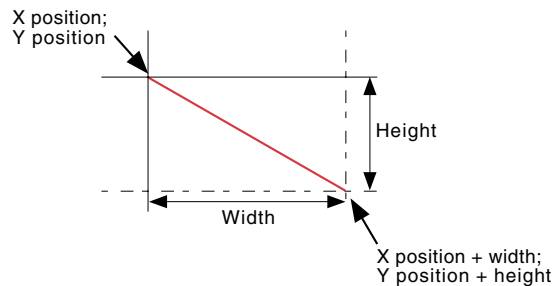

Figure 7.4.19a Line definitions

EXAMPLE

To draw an approximation to a St. Andrew's cross (saltire):

Access the component property editor page as described in [section 7.2.3](#):

Select [Advanced Edit level](#), then in the component property editor page

1. touch the 'Add' key at the top of the screen. In the 'List of Component types' page, press 'Line', 'Add', 'Line', 'Add', then 'Close'
2. In 'main_1.2' - set background colour to 6
4. In 'line_2.3' Set Width to 100, Height to 100. Set Foreground colour to 55 and Line thickness to 35
5. In 'line_3.4' - Set X position to 100, Width to -100, Height to 100. Set Foreground colour to 55 and Line thickness to 35
6. Press 'Save', then 'Close'.

Note: because of the thickness of the lines takes the corners beyond the display area, an error message may appear in the 'Last error' field for the lines : position maybe out of bounds. This should not prevent the screen being drawn correctly.



Figure 7.4.19b Example

7.4.20 Arc

This causes a curved line of user-definable thickness to be drawn anti-clockwise between start angle and (start angle + arc angle). The origin ('centre') of the arc is (X position + 1/2 Width); (Y position + 1/2 Height). Arcs cannot be filled.

Notes:

- 1 Angle increases anticlockwise
- 2 Height = 2/3 width if measuring in percent
- 3 Arcs cannot be filled - the shading in the figure is included for clarity only

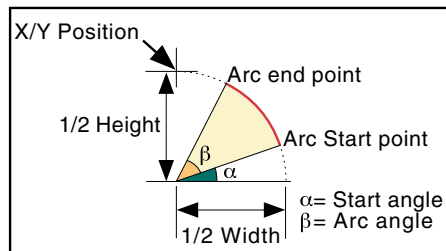

Figure 7.4.20a Arc dimension definitions

EXAMPLE

An arc definition of:

X position = 50%, Y position = 50%, Width = 50%, Height = 50%, Start angle = 0; Arc angle 270 would produce the curve depicted in figure 7.4.20b, below.

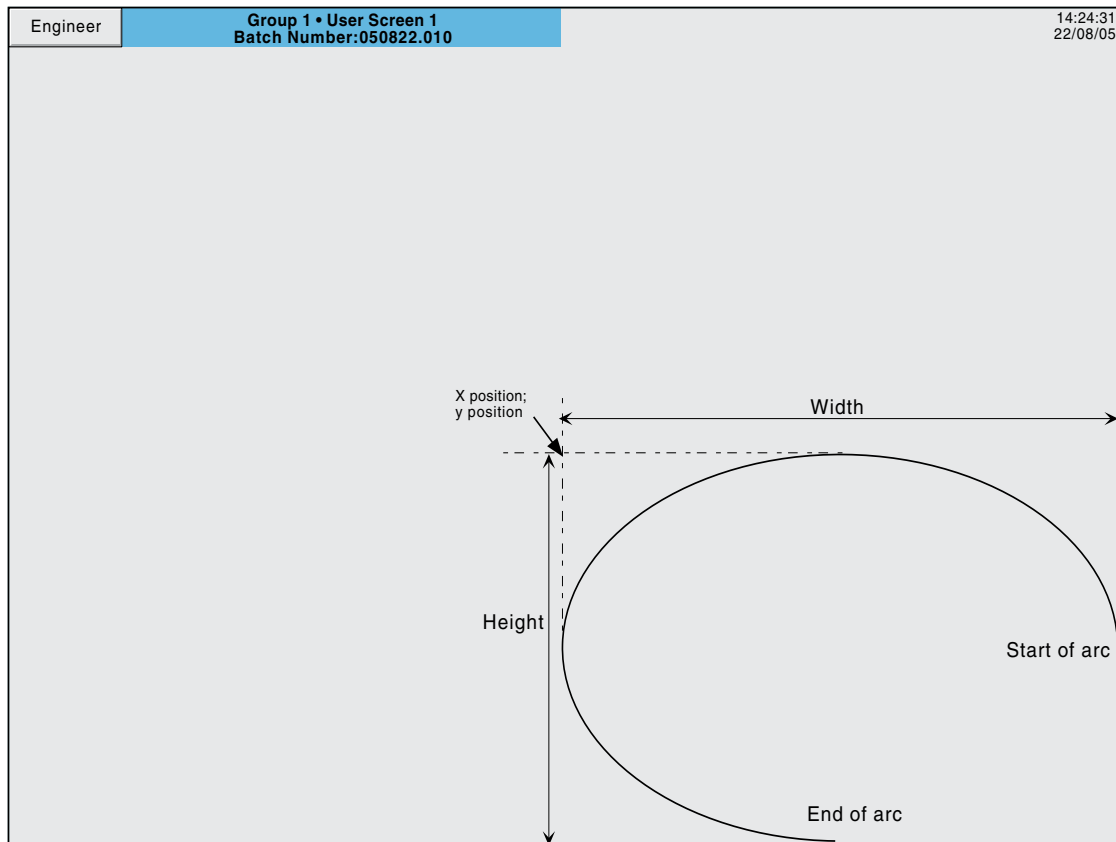

Figure 7.4.20b Sample arc

7.5 MEASURING UNIT COMPARISONS

Note: All the following figures are approximate.

7.5.1 XGA screen

The physical display screen area available for user screens is approximately 245 mm across and 164 mm high. This area can be divided into a 100 x 100 array for percentage measurement or into a pixel array, 1024 across by 700 vertically.

Thus, horizontally,

$$10 \text{ mm} = 4\% = 42 \text{ pixels}$$

or $1\% = 2.45 \text{ mm} = 10.24 \text{ pixels}$

or $10 \text{ pixels} = 2.45 \text{ mm}$

and Vertically,

$$10 \text{ mm} = 6\% = 43 \text{ pixels}$$

or $1\% = 1.64 \text{ mm} = 7 \text{ pixels}$

or $10 \text{ pixels} = 2.3 \text{ mm}$

Centre of screen is given by X = 50%; Y = 50% or by X = 512 pixels; Y = 350 pixels

7.5.2 QVGA screen

The physical display screen area available for user screens is approximately 100 mm across and 72 mm high. This area can be divided into a 100 x 100 array for percentage measurement or into a pixel array, 320 across by 210 vertically.

Thus, horizontally,

$$10 \text{ mm} = 10\% = 32 \text{ pixels}$$

or $1\% = 1 \text{ mm} = 3.2 \text{ pixels}$

or $10 \text{ pixels} = 3.2 \text{ mm}$

and Vertically,

$$10 \text{ mm} = 13\% = 29 \text{ pixels}$$

or $1\% = 0.72 \text{ mm} = 2.4 \text{ pixels}$

or $10 \text{ pixels} = 3.4 \text{ mm}$

Centre of screen is given by X = 50%; Y = 50% or by X = 160 pixels; Y = 105 pixels

7.6 ERROR CODES

Error codes 1 to F may appear at the top left corner of the screen. The following codes are currently implemented, and if more than one occurs at the same time, the code numbers are added. For example, Error code 6 would mean that codes 4 and 2 had both occurred.

- 1 Component error e.g. image does not exist.
- 2 Error loading the Property.uhr file
- 4 Error loading the Style.uhr file
- 8 Error loading the usscrn.uhu file

8 MODBUS TCP SLAVE COMMS

8.1 INSTALLATION

The installation of the Modbus link consists of connecting a standard Ethernet cable between the RJ45 connector at the rear of the recorder either:

1. Directly to a host computer, using a crossover cable
2. To a host computer via a network, using a 'straight through' cable.

8.2 INTRODUCTION

MODBUS TCP allows one or more recorders to act as 'slave' devices to one or more host computers connected via the RJ45 connector at the rear of the recorder. Each recorder must have a unique Internet Protocol (IP) address, set up as described in [Section 4.5](#).

MODBUS TCP (Transmission Control Protocol) is a variant of the MODBUS family of communications protocols intended for supervision and control of automated equipment specifically covering the use of MODBUS messaging in an intranet or internet environment, using TCP/IP protocols. Much of the MODBUS detail in this manual is derived from the document openmbus.doc, available at <http://www.modbus.org/default.htm>. The above mentioned document also includes implementation guidelines for users.

Note: The Modbus protocol allows a maximum of 255 data bytes to be read from or written to in one transaction. For this reason, the maximum number of standard (16 bit) registers that can be accessed in one transaction is $255/2 = 127$ and the maximum number of IEEE (32-bit) registers is $127/2 = 63$.

8.2.1 Function Codes

MODBUS function codes 3, 4, 6, 8 and 16, defined in table 8.2.1a below, are supported and are fully described in [section 8.5](#), below.

Code	MODBUS definition	Description
03	Read holding registers	Reads the binary contents of holding registers. In this implementation, code 03 is identical with code 04.
04	Read input registers	Reads the binary contents of input registers. In this implementation, code 04 is identical with code 03.
06	Pre-set single register	Writes a single value to a single register.
08	Diagnostics	Obtains communications diagnostics information
16	Pre-set multiple Registers	Writes values to multiple holding registers

Table 8.2.1a MODBUS Function code definition

DIAGNOSTIC CODES

Function code 08, subfunction 00 (Return query data) echoes the query (Loop back).

EXCEPTION CODES

MODBUS TCP provides reserved codes used for exceptions. These codes provide error information relating to failed requests. Exceptions are signalled by hex 80 being added to the function code of the request, followed by one of the codes listed in table 8.2.1b, below.

Code		MODBUS definition	Description (see Modbus specification for full details)
Dec	Hex		
01	01	Illegal Function	An invalid function code was received
02	02	Illegal Data Address	An invalid data address was received
03	03	Illegal Data Value	An invalid data value was received
04	04	Slave Device Failure	An unrecoverable error occurred in the recorder
09	09	Illegal Sub Function	An invalid sub function was received.
10	0A	Gateway path unavailable	Gateway misconfigured or overloaded.
11	0B	Gateway target device failed to respond	Device not present on the network

Table 8.2.1b Exception codes

8.2.2 Data types

The following data types are supported:

- 1 2's complement signed 16-bit analogue values with implied decimal point. The decimal point position must be configured in both the recorder and the host computer.
- 2 2's complement, 16, 32 and 64 bit signed integers.
- 3 16-bit unsigned integer values.
- 4 32 bit IEEE Floating point values.
- 5 Strings of limited size, can be transferred across Modbus TCP in ASCII format using a single non-multiplexed set of consecutive registers.

DATA ENCODING

MODBUS uses what is called a 'Big endian' representation for addresses and data items. This means that when a numerical quantity larger than a single byte is transmitted, the most significant byte is sent first. For example a 32-bit hex value of 12345678 would be transmitted as 12, followed by 34, followed by 56 and finally 78.

8.2.3 Invalid multiple register writes

When a recorder receives a multi-register write request, it is possible that one or more requests will be rejected. Under such a circumstance, the recorder will accept all valid write requests and ignore any invalid writes. No error response is produced.

8.2.4 Security

The recorder has a local file in which are stored all users' login information, as set up in Security/Access configuration ([section 4.4](#)) it must then supply the correct Username and Password. Should a host fail to login after three attempts, the recorder will terminate the connection.

This MODBUS security function can be enabled/disabled in the Operator/Config/Instrument menu ([section 4.3.1](#)).

Note: Modbus Security must be disabled in order for Modbus communications to be established. Once the Master is communicating with the Slave, Modbus security can be re-enabled, providing that the master has the correct remote user name and password data for the relevant slave. If this information is missing, all read/write requests will be ignored by the slave.

8.2.4 SECURITY (Cont.)

The following C++ code is intended for use in creating a suitable 16-bit encrypted register using an IP address and password:

```

/*-----
    FUNCTION : MB_Driver::encrypt
    DESCRIPTION : Create an encrypted value from a password string
    ARGUMENTS : pswd : Pointer to password from network file
                eKey : Pointer to eKey, usually I.P. address (must be 4 bytes)
    RETURN : result : A 16 bit value representing the encryption result
    NOTES : None
-----*/
Ushort MB_Driver::encrypt(cchar *pswd, cchar *ipAddr)
{
    Uchar key1;
    Uchar key2;
    Ushort dataLen;
    Uchar  ibyte;
    Ushort byteResult = 0;
    Uchar *encryptedData = NULL;
    Uchar eKeys[4];
    Ulong ipAddress;
    /* Convert ip address to an unsigned long value so that we can manipulate
       each of the 4 bytes, to be used as our private keys */
    ipAddress = inet_addr(ipAddr);
    // Now split the bytes up by copying the IP address into a byte array
    memcpy(eKeys, &ipAddress, sizeof(Ulong));
    // From the 4 bytes of the IP address create two exclusive keys
    key1 = eKeys[0] ^ eKeys[3];
    key2 = eKeys[1] ^ eKeys[2];
    // Calculate the length of the string to be encrypted
    dataLen = strlen(pswd);
    // Create some memory to store the new encrypted password
    encryptedData = (Uchar*) malloc(sizeof(Uchar)*dataLen);
    /* Copy the unencrypted password into a byte array, so we can use the
       character code as each byte value */
    memcpy(encryptedData, pswd, dataLen);
    /* Perform EXOR comparison between keys and raw data.
       Perform the operation on each byte using alternate key values
       starting at byte 1 with key 1 */
    for(ibyte=0; ibyte < dataLen; )
    {
        // EXOR with the key1
        encryptedData[ibyte++] ^= key1;
    }
}

```

(Continued)

8.2.4 SECURITY (Cont.)

```
// Compare the next byte with key2
if(ibyte < dataLen)
{
    encryptedData[ibyte++] ^= key2;
}
}
/* Now EXOR each byte to the next byte until no more are available
if all goes well the last byte in the array should never change */
for(ibyte=0; ibyte < (dataLen-1); ibyte++)
{
    encryptedData[ibyte] = (encryptedData[ibyte] ^ encryptedData[ibyte+1]);
}
// Now add all the bytes together to get a 16 bit value result
for(ibyte=0; ibyte < dataLen; ibyte++)
{
    byteResult += encryptedData[ibyte];
}
// Return the encrypted string as a 16 bit value
return(byteResult);
}
```

Notes:

1. If login is accepted, a standard response is sent to the master
 2. If three invalid logins are sent, by the master, then an 'illegal address' exception code (2) is sent to the master.
-

8.2.4 SECURITY (Cont.)

TO SEND A LOGIN REQUEST

Request

Figure 8.2.4a shows data transmission sequence for sending a login request to a recorder with Modbus address 1, using the Ethernet network connection. Figure 8.2.4b is the same message for use with serial communications.

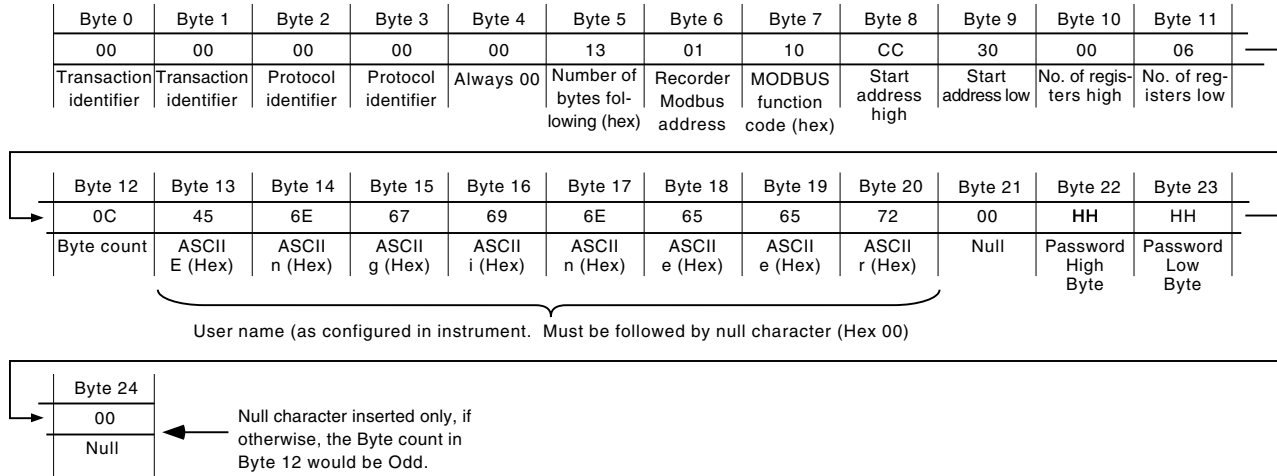

Figure 8.2.4a Login request via Ethernet (Modbus TCP)

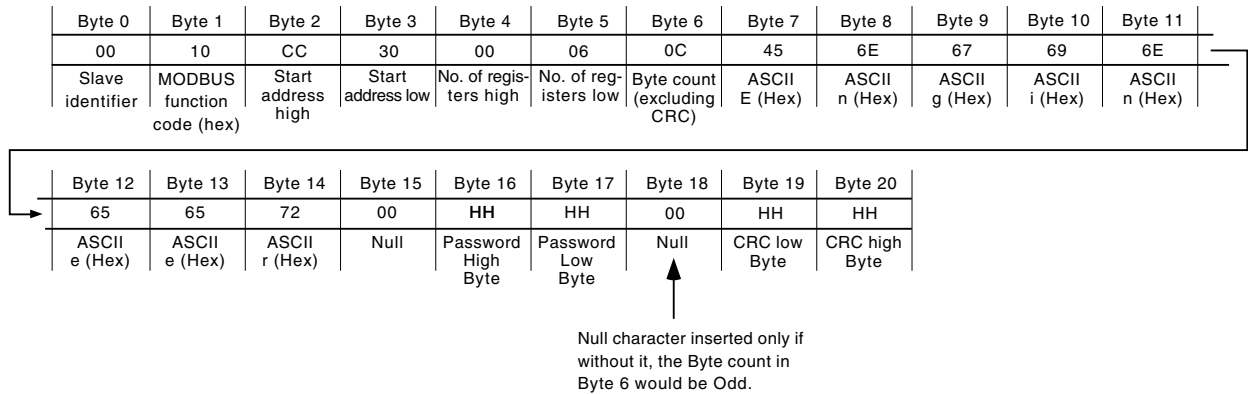

Figure 8.2.4b Login Request using a serial transmission line.

Notes:

- 1 The high and low password bytes are entered using the result of the encryption program above. If the password is blank, both High and Low Bytes must be 00 (null).
- 2 For successful login, the 'Connect from remote' item must be enabled (ref. 'Access levels in section 4.4.1).

8.2.4 SECURITY (Cont.)**TO SEND A LOGIN REQUEST (Cont.)**

Response

Figures 8.2.4c and 8.2.4d show response messages for successful and non-successful login attempts.

Byte 0	Byte 1	Byte 2	Byte 3	Byte 4	Byte 5	Byte 6	Byte 7	Byte 8	Byte 9	Byte 10	Byte 11
00	00	00	00	00	06	01	10	CC	30	00	05
Transaction identifier	Transaction identifier	Protocol identifier	Protocol identifier	Always 00	Number of bytes following (hex)	Recorder Modbus address	Modbus function code (hex)	Start Address high	Start Address low	No. of registers high	No. of registers low

Figure 8.2.4c Response to a successful login attempt

Byte 0	Byte 1	Byte 2	Byte 3	Byte 4	Byte 5	Byte 6	Byte 7	Byte 8
00	00	00	00	00	04	01	90	02
Transaction identifier	Transaction identifier	Protocol identifier	Protocol identifier	Always 00	Number of bytes following (hex)	Recorder Modbus address	Modbus function code+ MSB set (hex)	Exception code

Figure 8.2.4d Response after an unsuccessful login attempt

Note: MSB = Most Significant Bit

8.2.5 Text messages

In order to increase efficiency, it is possible to set the system to transmit screen messages (e.g. alarm on/off) only when a new message occurs. This is done by continuously polling the 'Text Length' parameter (in group data - [section 8.4.4](#)) to see if its value is non-zero. (This parameter contains the character count of the latest message to occur since the last poll.)

If 'text length' is non-zero, the host must access the parameter 'Read Text' (also in group data) to read the message, and it must also reset the 'Text Length' parameter to zero. This causes the recorder to look for any further messages in the queue, and if there are, it will load the latest message into the area accessed by 'Read Data', and then set 'Text Length' to the length of the new message. If the host fails to set Text Length to zero after reading a message, no new messages will be read.

If 'Text Length' is zero, no new messages have been generated since the last poll.

LONG MESSAGES

All messages are terminated with a null character.

Messages of up to 60 characters (including the time and date and the terminating 'null') can be read by the master device in a single transaction.

If the message contains more than 60 characters, one or more continuation messages of up to 60 characters each are placed in 'Read Text', as soon as the previous message has been confirmed as 'read'. The master can continue to read all these messages, until it detects a 'null' character. Intelligent masters can then re-assemble the characters into a single message. Non-intelligent masters can treat the continuation messages as separate messages sent at the same time as the first message.

Notes:

1. If any of the messages is of less than 60 characters, the unused part of message is filled with 'null' characters (example 1). Thus, by reading character 60, the master can determine either that this is the last message (character 60 = 'null'), or that there is at least one message to follow (character 60 is not 'null').
2. Continuation messages cannot contain only null characters. For this reason, if the message itself (i.e. excluding final 'null' characters) is exactly 60 characters long (or a multiple of 60 characters long) then the final extension message contains a space, followed by 59 'nulls' (Example 2).
3. Time and date appear only in the main message, not the continuation message(s).

Example 1

Message of less than 60 characters

Character no. →	1	2	3	4	5	6	7	8	9	10	11	12	13	14	15	16	17	18	19	20	21	22	23	24	25	26	27	28	29	30	31	32	33	34	35	36	37	38	39	40	41	42	43	44	45	46	47	48	49	50	51	52	53	54	55	56	57	58	59	60			
English message →	04/04/02						16:31:05						Batch stopped because of belt failure																																																		
ASCII (Hex) →	30	34	2F	30	34	2F	30	32	20	31	36	3A	33	31	3A	30	35	20	42	61	74	63	68	20	73	74	6F	70	70	65	64	20	62	65	63	61	75	73	65	20	6F	66	20	62	65	6C	74	20	66	61	69	6C	75	72	65	20	42	54	30	00	00	00	00

Example 2

Message of exactly 60 characters

Message	1	2	3	4	5	6	7	8	9	10	11	12	13	14	15	16	17	18	19	20	21	22	23	24	25	26	27	28	29	30	31	32	33	34	35	36	37	38	39	40	41	42	43	44	45	46	47	48	49	50	51	52	53	54	55	56	57	58	59	60			
	04/04/02						16:31:05						Batch stopped because of belt failure BT01																																																		
	30	34	2F	30	34	2F	30	32	20	31	36	3A	33	31	3A	30	35	20	42	61	74	63	68	20	73	74	6F	70	70	65	64	20	62	65	63	61	75	73	65	20	6F	66	20	62	65	6C	74	20	66	61	69	6C	75	72	65	20	42	54	30	01			
Space = hex 20; Null = 00																																																															
Extension message (Space + 59 null characters)	1	2	3	4	5	6	7	8	9	10	11	12	13	14	15	16	17	18	19	20	21	22	23	24	25	26	27	28	29	30	31	32	33	34	35	36	37	38	39	40	41	42	43	44	45	46	47	48	49	50	51	52	53	54	55	56	57	58	59	60			
	20	00	00	00	00	00	00	00	00	00	00	00	00	00	00	00	00	00	00	00	00	00	00	00	00	00	00	00	00	00	00	00	00	00	00	00	00	00	00	00	00	00	00	00	00	00	00	00	00	00	00	00	00	00	00	00	00	00	00	00	00	00	00

8.2.5 TEXT MESSAGES (Cont.)

Example 3

Message of more than 60 but less than 120 characters

	1	2	3	4	5	6	7	8	9	10	11	12	13	14	15	16	17	18	19	20	21	22	23	24	25	26	27	28	29	30	31	32	33	34	35	36	37	38	39	40	41	42	43	44	45	46	47	48	49	50	51	52	53	54	55	56	57	58	59	60						
Message	0	4	/	0	4	/	0	2		1	6	:	3	1	:	0	5		B	a	t	c	h		s	t	o	p	p	e	d		b	e	c	a	u	s	e		o	f		b	e	l	t		f	a	i	l	u	r	e		o	n		l						
	30	34	2F	30	34	2F	30	32	20	31	36	3A	33	31	3A	30	35	20	42	61	74	63	68	20	73	74	6F	70	70	65	64	20	62	65	63	61	75	73	65	20	6F	66	20	62	65	6C	74	20	66	61	69	6C	75	72	65	20	6F	6E	20	6C						
	Space = hex 20; Null = 00																																																																	
Extension message	i	n	e		3		s	e	c	t	i	o	n		1	7																																																		
	69	6E	65	20	33	20	73	65	63	74	69	6F	6E	20	31	37	00	00	00	00	00	00	00	00	00	00	00	00	00	00	00	00	00	00	00	00	00	00	00	00	00	00	00	00	00	00	00	00	00	00	00	00	00	00	00	00	00	00	00	00	00	00	00	00	00	00

8.3 ADDRESS MAP

Figure 8.3 shows the range of addresses allocated to various recorder functions. Each of these functions is described in detail in later sections.

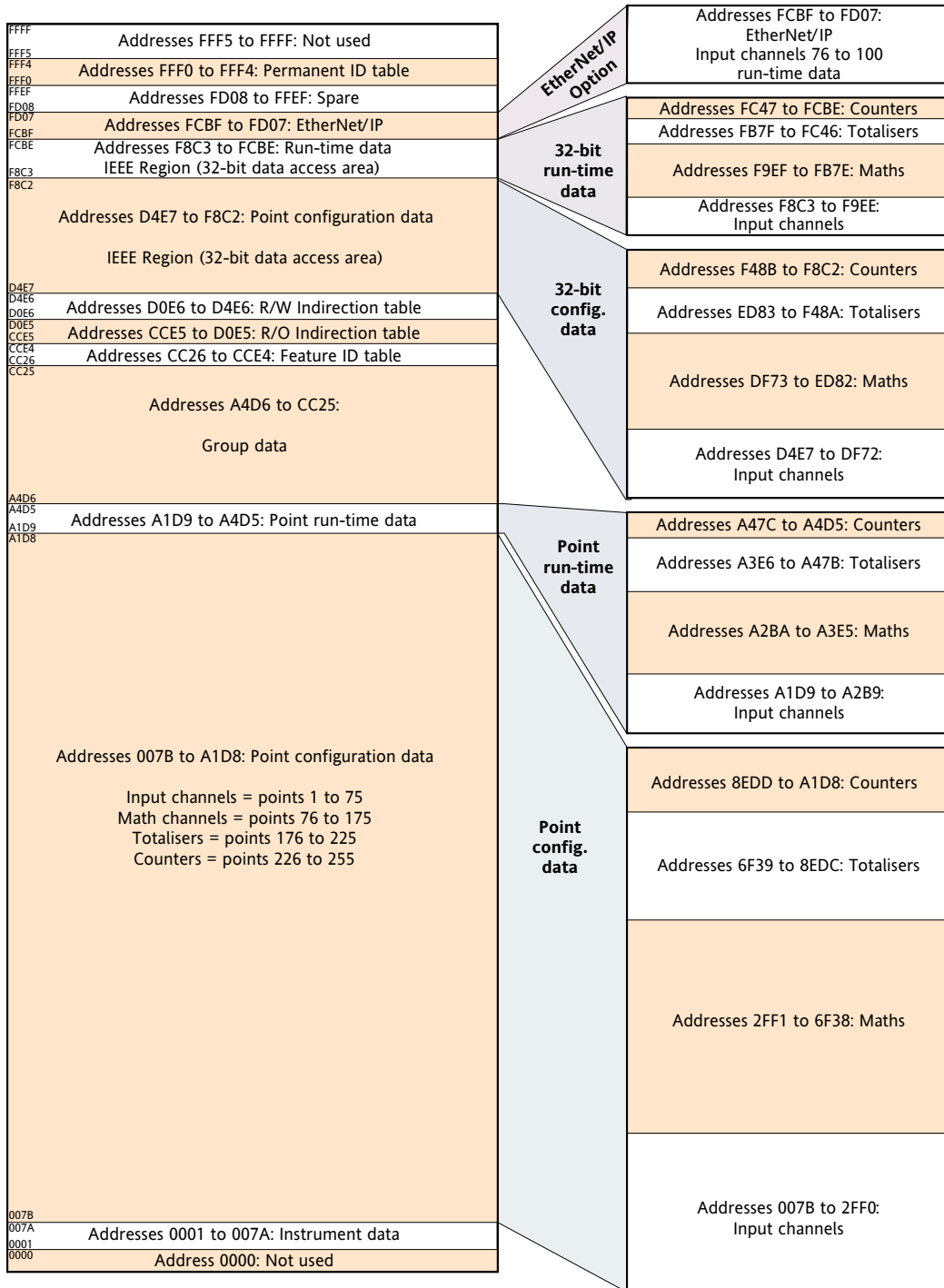

Figure 8.3 Address map representation

Notes:

- 1 All addresses in hexadecimal
- 2 Areas represent relative sizes, but are not to scale

8.3 ADDRESS MAP (Cont.)

The contents of each group can be determined by reading the relevant register number, as shown in [section 8.4.4](#), below. The table below is a decoder for the results.

For example, if a group has channels 1 to 6, maths channel 1 and totaliser three fitted, the results would be:

Register 1 = 63 (32 + 16 + 8 + 4 + 2 + 1) (channels 1 to 6)

Register 5 = 2048 (maths channel 1)

Register 12 = 2 (Totaliser 1)

All other register values = 0

Value if bit set →		1	2	4	8	16	32	64	128	256	512	1024	2048	4096	8192	16384	32768	
Bit number →		0	1	2	3	4	5	6	7	8	9	10	11	12	13	14	15	
Register Number	1	1	2	3	4	5	6	7	8	9	10	11	12	13	14	15	16	
	2	17	18	19	20	21	22	23	24	25	26	27	28	29	30	31	32	
	3	33	34	35	36	37	38	39	40	41	42	43	44	45	46	47	48	
	4	49	50	51	52	53	54	55	56	57	58	59	60	61	62	63	64	
	5	65	66	67	68	69	70	71	72	73	74	75	M1	M2	M3	M4	M5	
	6	M6	M7	M8	M9	M10	M11	M12	M13	M14	M15	M16	M17	M18	M19	M20	M21	
	7	M22	M23	M24	M25	M26	M27	M28	M29	M30	M31	M32	M33	M34	M35	M36	M37	
	8	M38	M39	M40	M41	M42	M43	M44	M45	M46	M47	M48	M49	M50	M51	M52	M53	
	9	M54	M55	M56	M57	M58	M59	M60	M61	M62	M63	M64	M65	M66	M67	M68	M69	
	10	M70	M71	M72	M73	M74	M75	M76	M77	M78	M79	M80	M81	M82	M83	M84	M85	
	11	M86	M87	M88	M89	M90	M91	M92	M93	M94	M95	M96	M97	M98	M99	M100	T1	
	12	T2	T3	T4	T5	T6	T7	T8	T9	T10	T11	T12	T13	T14	T15	T16	T17	
	13	T18	T19	T20	T21	T22	T23	T24	T25	T26	T27	T28	T29	T30	T31	T32	T33	
	14	T34	T35	T36	T37	T38	T39	T40	T41	T42	T43	T44	T45	T46	T47	T48	T49	
	15	T50	C1	C2	C3	C4	C5	C6	C7	C8	C9	C10	C11	C12	C13	C14	C15	
	16	C16	C17	C18	C19	C20	C21	C22	C23	C24	C25	C26	C27	C28	C29	C30		

Table 8.3 'Channels in group' interpretation

8.4 ADDRESS ALLOCATION

This section consists of a number of tables showing how the address space within the memory map is allocated. For full details of configuration parameters, refer to [section 4](#). For convenience, the word 'channel' is used as an umbrella term for measuring points in general (i.e. input channels, maths channels, totalisers etc.).

The following 'types' are used in the tables.

- 1 Uint16 16 bit unsigned integer.
- 2 Uint32 32 bit unsigned integer.
- 3 Uint64 64 bit unsigned integer.
- 4 Scaled Double precision floating point value scaled to represent single precision 16-bit integer between - 32,767 and + 32,767.
- 5 Boolean Represented as a single 16 bit integer.
- 6 Enum Enumeration value - represented by a single 16 bit character.
- 7 16, 32 and 64-bit 2's complement signed integers.

Note: When reading a Process Variable (PV) values, as 'scaled' integers the position of the decimal point is set by the 'Max. Decimal Digits' parameter in the relevant Channel's Configuration. Only if the resulting value can be represented within 16 bit resolution (± 32767), will the value be transmitted accurately. For example, a value of 12.3456 needs more than 16-bit resolution, and the transmitted value would be the maximum value of 32767 (over range). Reducing the number of decimal places to three, for example (12.345) allows the value to be encoded as a 16-bit value which can be transmitted accurately.

8.4.1 Instrument data

Parameter Name	Description	Type	Access	Start Addr. Hex (Dec)	Register Length
Instrument type	Instrument type number	Uint16	Read only	0001 (1)	1
Instrument descriptor	Instrument descriptor (up to 20 characters)	String_20	Read only	0002 (2)	10
Reserved	Not used			000C (12)	10
Instrument status		Uint16	Read only	0016 (22)	1
	Bit 0: Not used (value always 0)		Read only		
	Bit 1: Not used (value always 0)		Read only		
	Bit 2: Not used (value always 0)		Read only		
	Bit 3: 0 = SD/Flash card inserted, 1 = Missing		Read only		
	Bit 4: 0 = SD/Flash card not full, 1 = Full		Read only		
	Bit 5: Not used (value always 0)		Read only		
	Bit 6: Not used (value always 0)		Read only		
	Bit 7: Not used (value always 0)		Read only		
	Bit 8: Not used (value always 0)		Read only		
	Bit 9: 0 = No channel failures, 1 = channel failure		Read only		
	Bits 10 to 15: Not used (value always 0)		Read only		
Config counter	Counts configuration changes. Powers up at zero, and is reset to zero at brown-out	Uint16	Read only	0017 (23)	1
Time	Current instrument time (UTC format)	Double	Read only	0018 (24)	4
Date	Current instrument date	Double	Read only	001C (28)	4
Global alarm acknowledge	'1' acknowledges all alarms. Other values: no effect	Uint16	Write only	0020 (32)	1
Spare	Not used			0021 (33)	74
Product version	Product version. Returns value HHHH (CNOMO*) (HHHH = version number in hex. E.G. 0401 = version 4.01)	Uint 16	Read only	006B (107)	1
Serial number	Returns 'Instrument Number' (see Section 4.5) in decimal.	Uint32	Read only	006C (108)	2
Not used				006E (110)	11
Company ID	Company ID. Returns value hex 0500 (CNOMO*)	Uint 16	Read only	0079 (121)	1
Product ID	Product ID. Returns model number in hex (CNOMO*)	Uint 16	Read only	007A (122)	1

* CNOMO = Comité de normalisation des moyens de production.

8.4.2 Channel configuration data

The following tables give hex addresses for channels 1 to 12, inclusive.

Note: A/B Switching:
B values are not accessible via modbus for this software version. Span, Zone, Colour etc. are therefore all setting A

Generally: channel N parameter address = channel 1 parameter address + 162 (N-1) (decimal).

CHANNEL 1

Parameter Name	Description	Type		Access	Start Addr. Hex (Dec)	Register Length
Ch1 Span high	Upper span value (display full scale)		Scaled	Read only	007B (123)	1
Ch1 Span low	Lower span value (display 'zero')		Scaled	Read only	007C (124)	1
Ch1 Zone high	Zone high value (two decimal places)		Scaled	Read only	007D (125)	1
Ch1 Zone low	Zone low value (two decimal places)		Scaled	Read only	007E (126)	1
Ch1 PV type	Input type 1 = Analogue input 3 = Totaliser 2 = Maths 4 = Counter		Enum	Read only	007F (127)	1
Ch1 Decimal places	Number of decimal places (0 to 9) (used by all scaled parameters except where stated)		Uint16	Read only	0080 (128)	1
Ch1 Colour	Channel colour (0 to 55) (See Annex B for RGB definitions)		Enum	Read only	0081 (129)	1
Ch1 Units	Units string (up to five characters)		String_5	Read only	0082 (130)	3
Spare					0085 (133)	2
Ch1 Open string	Open Digital Input string (up to eight characters)		String_8	Read only	0087 (135)	4
Spare					008B (139)	4
Ch1 Close string	Closed Digital Input string (up to eight characters)		String_8	Read only	008F (143)	4
Spare					0093 (147)	4
Ch1 Descriptor	Channel descriptor (up to 20 characters)		String_20	Read only	0097 (151)	10
Spare					00A1 (161)	10
Ch1 No of alarms	Number of alarms on this channel		Uint16	Read only	00AB (171)	1
Ch1 PV format	0 = Numeric 1 = Digital strings		Enum	Read only	00AC (172)	1
Spare					00AD (173)	60
Ch1 Alarm 1 enable	Alarm 1 enable 0 = Off 2 = Latched 1 = Unlatched 3 = Trigger		Enum	Read only	00E9 (233)	1
Ch1 Alarm 1 type	Alarm 1 type 0 = Absolute low 1 = Absolute high 2 = Deviation in 3 = Deviation out 4 = Rate of change rise 5 = Rate of change fall		Enum	Read only	00EA (234)	1
Ch1 Alarm 1 setpoint	Trigger setpoint (Note 2)		Scaled	Read/Write	00EB (235)	1
Spare					00EC (236)	10
Ch1 Alarm 2 enable	Alarm 2 enable (As alarm 1 enable above)		Enum	Read only	00F6 (246)	1
Ch1 Alarm 2 type	Alarm 2 type (As alarm 1 type above)		Enum	Read only	00F7 (247)	1
Ch1 Alarm 2 setpoint	Trigger setpoint (Note 2)		Scaled	Read/Write	00F8 (248)	1
Spare					00F9 (249)	10
Ch1 Alarm 3 enable	Alarm 3 enable (As alarm 1 enable above)		Enum	Read only	0103 (259)	1
Ch1 Alarm 3 type	Alarm 3 type (As alarm 1 type above)		Enum	Read only	0104 (260)	1
Ch1 Alarm 3 setpoint	Trigger setpoint (Note 2)		Scaled	Read/Write	0105 (261)	1
Spare					0106 (262)	10
Ch1 Alarm 4 enable	Alarm 4 enable (As alarm 1 enable above)		Enum	Read only	0110 (272)	1
Ch1 Alarm 4 type	Alarm 4 type (As alarm 1 type above)		Enum	Read only	0111 (273)	1
Ch1 Alarm 4 setpoint	Trigger setpoint (Note 2)		Scaled	Read/Write	0112 (274)	1
Spare					0113 (275)	10

Notes

1. For maths, totalisers and counters, see the relevant option description.
2. If an alarm's Setpoint Source ([section 4.3.3](#)) is set to anything other than 'Constant' the value returned will be the previously configured constant value.

8.4.2 CHANNEL CONFIGURATION DATA (Cont.)

CHANNEL 2

Parameter Name	Description	Type		Access	Start Addr. Hex (Dec)	Register Length
Ch2 Span high	Upper span value (display full scale)		Scaled	Read only	011D (285)	1
Ch2 Span low	Lower span value (display 'zero')		Scaled	Read only	011E (286)	1
Ch2 Zone high	Zone high value (two decimal places)		Scaled	Read only	011F (287)	1
Ch2 Zone low	Zone low value (two decimal places)		Scaled	Read only	0120 (288)	1
Ch2 PV type	Input type 1 = Analogue input 3 = Totaliser 2 = Maths 4 = Counter		Enum	Read only	0121 (289)	1
Ch2 Decimal places	Number of decimal places (0 to 9) (used by all scaled parameters except where stated)		Uint16	Read only	0122 (290)	1
Ch2 Colour	Channel colour (0 to 55) (See Annex B for RGB definitions)		Enum	Read only	0123 (291)	1
Ch2 Units	Units string (up to five characters)		String_5	Read only	0124 (292)	3
Spare					0127 (295)	2
Ch2 Open string	Open Digital Input string (up to eight characters)		String_8	Read only	0129 (297)	4
Spare					012D (301)	4
Ch2 Close string	Closed Digital Input string (up to eight characters)		String_8	Read only	0131 (305)	4
Spare					0135 (309)	4
Ch2 Descriptor	Channel descriptor (up to 20 characters)		String_20	Read only	0139 (313)	10
Spare					0143 (323)	10
Ch2 No of alarms	Number of alarms on this channel (0 to 2)		Uint16	Read only	014D (333)	1
Ch2 PV format	0 = Numeric 1 = Digital strings		Enum	Read only	014E (334)	1
Spare					014F (335)	60
Ch2 Alarm 1 enable	Alarm 1 enable 0 = Off 2 = Latched 1 = Unlatched 3 = Trigger		Enum	Read only	018B (395)	1
Ch2 Alarm 1 type	Alarm 1 type 0 = Absolute low 1 = Absolute high 2 = Deviation in 3 = Deviation out 4 = Rate of change rise 5 = Rate of change fall		Enum	Read only	018C (396)	1
Ch2 Alarm 1 setpoint	Trigger setpoint (Note 2)		Scaled	Read/Write	018D (397)	1
Spare					018E (398)	10
Ch2 Alarm 2 enable	Alarm 2 enable (As alarm 1 enable, above)		Enum	Read only	0198 (408)	1
Ch2 Alarm 2 type	Alarm 2 type (As alarm 1 type, above)		Enum	Read only	0199 (409)	1
Ch2 Alarm 2 setpoint	Trigger setpoint (Note 2)		Scaled	Read/Write	019A (410)	1
Spare					019B (411)	10
Ch2 Alarm 3 enable	Alarm 3 enable (As alarm 1 enable above)		Enum	Read only	01A5 (421)	1
Ch2 Alarm 3 type	Alarm 3 type (As alarm 1 type above)		Enum	Read only	01A6 (422)	1
Ch2 Alarm 3 setpoint	Trigger setpoint (Note 2)		Scaled	Read/Write	01A7 (423)	1
Spare					01A8 (424)	10
Ch2 Alarm 4 enable	Alarm 4 enable (As alarm 1 enable above)		Enum	Read only	01B2 (434)	1
Ch2 Alarm 4 type	Alarm 4 type (As alarm 1 type above)		Enum	Read only	01B3 (435)	1
Ch2 Alarm 4 setpoint	Trigger setpoint (Note 2)		Scaled	Read/Write	01B4 (436)	1
Spare					01B5 (437)	10

Notes

1. For maths, totalisers and counters, see the relevant option description.
2. If an alarm's Setpoint Source ([section 4.3.3](#)) is set to anything other than 'Constant' the value returned will be the previously configured constant value.

8.4.2 CHANNEL CONFIGURATION DATA (Cont.)

CHANNEL 3

Parameter Name	Description	Type		Access	Start Addr. Hex (Dec)	Register Length
Ch3 Span high	Upper span value (display full scale)		Scaled	Read only	01BF (447)	1
Ch3 Span low	Lower span value (display 'zero')		Scaled	Read only	01C0 (448)	1
Ch3 Zone high	Zone high value (two decimal places)		Scaled	Read only	01C1 (449)	1
Ch3 Zone low	Zone low value (two decimal places)		Scaled	Read only	01C2 (450)	1
Ch3 PV type	Input type 1 = Analogue input 3 = Totaliser 2 = Maths 4 = Counter		Enum	Read only	01C3 (451)	1
Ch3 Decimal places	Number of decimal places (0 to 9) (used by all scaled parameters except where stated)		Uint16	Read only	01C4 (452)	1
Ch3 Colour	Channel colour (0 to 55) (See Annex B for RGB definitions)		Enum	Read only	01C5 (453)	1
Ch3 Units	Units string (up to five characters)		String_5	Read only	01C6 (454)	3
Spare					01C9 (457)	2
Ch3 Open string	Open Digital Input string (up to eight characters)		String_8	Read only	01CB (459)	4
Spare					01CF (463)	4
Ch3 Close string	Closed Digital Input string (up to eight characters)		String_8	Read only	01D3 (467)	4
Spare					01D7 (471)	4
Ch3 Descriptor	Channel descriptor (up to 20 characters)		String_20	Read only	01DB (475)	10
Spare					01E5 (485)	10
Ch3 No of alarms	Number of alarms on this channel (0 to 2)		Uint16	Read only	01EF (495)	1
Ch3 PV format	0 = Numeric 1 = Digital strings		Enum	Read only	01F0 (496)	1
Spare					01F1 (497)	60
Ch3 Alarm 1 enable	Alarm 1 enable 0 = Off 2 = Latched 1 = Unlatched 3 = Trigger		Enum	Read only	022D (557)	1
Ch3 Alarm 1 type	Alarm 1 type 0 = Absolute low 1 = Absolute high 2 = Deviation in 3 = Deviation out 4 = Rate of change rise 5 = Rate of change fall		Enum	Read only	022E (558)	1
Ch3 Alarm 1 setpoint	Trigger setpoint (Note 2)		Scaled	Read/Write	022F (559)	1
Spare					0230 (560)	10
Ch3 Alarm 2 enable	Alarm 2 enable (As alarm 1 enable, above)		Enum	Read only	023A (570)	1
Ch3 Alarm 2 type	Alarm 2 type (As alarm 1 type, above)		Enum	Read only	023B (571)	1
Ch3 Alarm 2 setpoint	Trigger setpoint (Note 2)		Scaled	Read/Write	023C (572)	1
Spare					023D (573)	10
Ch3 Alarm 3 enable	Alarm 3 enable (As alarm 1 enable above)		Enum	Read only	0247 (583)	1
Ch3 Alarm 3 type	Alarm 3 type (As alarm 1 type above)		Enum	Read only	0248 (584)	1
Ch3 Alarm 3 setpoint	Trigger setpoint (Note 2)		Scaled	Read/Write	0249 (585)	1
Spare					024A (586)	10
Ch3 Alarm 4 enable	Alarm 4 enable (As alarm 1 enable above)		Enum	Read only	0254 (596)	1
Ch3 Alarm 4 type	Alarm 4 type (As alarm 1 type above)		Enum	Read only	0255 (597)	1
Ch3 Alarm 4 setpoint	Trigger setpoint (Note 2)		Scaled	Read/Write	0256 (598)	1
Spare					0257 (599)	10

Notes

1. For maths, totalisers and counters, see the relevant option description.
2. If an alarm's Setpoint Source ([section 4.3.3](#)) is set to anything other than 'Constant' the value returned will be the previously configured constant value.

8.4.2 CHANNEL CONFIGURATION DATA (Cont.)

CHANNEL 4

Parameter Name	Description	Type	Access	Start Addr. Hex (Dec)	Register Length
Ch4 Span high	Upper span value (display full scale)	Scaled	Read only	0261 (609)	1
Ch4 Span low	Lower span value (display 'zero')	Scaled	Read only	0262 (610)	1
Ch4 Zone high	Zone high value (two decimal places)	Scaled	Read only	0263 (611)	1
Ch4 Zone low	Zone low value (two decimal places)	Scaled	Read only	0264 (612)	1
Ch4 PV type	Input type 1 = Analogue input 3 = Totaliser 2 = Maths 4 = Counter	Enum	Read only	0265 (613)	1
Ch4 Decimal places	Number of decimal places (0 to 9) (used by all scaled parameters except where stated)	Uint16	Read only	0266 (614)	1
Ch4 Colour	Channel colour (0 to 55) (See Annex B for RGB definitions)	Enum	Read only	0267 (615)	1
Ch4 Units	Units string (up to five characters)	String_5	Read only	0268 (616)	3
Spare				026B (619)	2
Ch4 Open string	Open Digital Input string (up to eight characters)	String_8	Read only	026D (621)	4
Spare				0271 (625)	4
Ch4 Close string	Closed Digital Input string (up to eight characters)	String_8	Read only	0275 (629)	4
Spare				0279 (633)	4
Ch4 Descriptor	Channel descriptor (up to 20 characters)	String_20	Read only	027D (637)	10
Spare				0287 (647)	10
Ch4 No of alarms	Number of alarms on this channel (0 to 2)	Uint16	Read only	0291 (657)	1
Ch4 PV format	0 = Numeric 1 = Digital strings	Enum	Read only	0292 (658)	1
Spare				0293 (659)	60
Ch4 Alarm 1 enable	Alarm 1 enable 0 = Off 2 = Latched 1 = Unlatched 3 = Trigger	Enum	Read only	02CF (719)	1
Ch4 Alarm 1 type	Alarm 1 type 0 = Absolute low 1 = Absolute high 2 = Deviation in 3 = Deviation out 4 = Rate of change rise 5 = Rate of change fall	Enum	Read only	02DO (720)	1
Ch4 Alarm 1 setpoint	Trigger setpoint (Note 2)	Scaled	Read/Write	02D1 (721)	1
Spare				02D2 (722)	10
Ch4 Alarm 2 enable	Alarm 2 enable (As alarm 1 enable, above)	Enum	Read only	02DC (732)	1
Ch4 Alarm 2 type	Alarm 2 type (As alarm 1 type, above)	Enum	Read only	02DD (733)	1
Ch4 Alarm 2 setpoint	Trigger setpoint (Note 2)	Scaled	Read/Write	02DE (734)	1
Spare				02DF (735)	10
Ch4 Alarm 3 enable	Alarm 3 enable (As alarm 1 enable above)	Enum	Read only	02E9 (745)	1
Ch4 Alarm 3 type	Alarm 3 type (As alarm 1 type above)	Enum	Read only	02EA (746)	1
Ch4 Alarm 3 setpoint	Trigger setpoint (Note 2)	Scaled	Read/Write	02EB (747)	1
Spare				02EC (748)	10
Ch4 Alarm 4 enable	Alarm 4 enable (As alarm 1 enable above)	Enum	Read only	02F6 (758)	1
Ch4 Alarm 4 type	Alarm 4 type (As alarm 1 type above)	Enum	Read only	02F7 (759)	1
Ch4 Alarm 4 setpoint	Trigger setpoint (Note 2)	Scaled	Read/Write	02F8 (760)	1
Spare				02F9 (761)	10

Notes

1. For maths, totalisers and counters, see the relevant option description.
2. If an alarm's Setpoint Source ([section 4.3.3](#)) is set to anything other than 'Constant' the value returned will be the previously configured constant value.

8.4.2 CHANNEL CONFIGURATION DATA (Cont.)

CHANNEL 5

Parameter Name	Description	Type	Access	Start Addr. Hex (Dec)	Register Length
Ch5 Span high	Upper span value (display full scale)	Scaled	Read only	0303 (771)	1
Ch5 Span low	Lower span value (display 'zero')	Scaled	Read only	0304 (772)	1
Ch5 Zone high	Zone high value (two decimal places)	Scaled	Read only	0305 (773)	1
Ch5 Zone low	Zone low value (two decimal places)	Scaled	Read only	0306 (774)	1
Ch5 PV type	Input type 1 = Analogue input 3 = Totaliser 2 = Maths 4 = Counter	Enum	Read only	0307 (775)	1
Ch5 Decimal places	Number of decimal places (0 to 9) (used by all scaled parameters except where stated)	Uint16	Read only	0308 (776)	1
Ch5 Colour	Channel colour (0 to 55) (See Annex B for RGB definitions)	Enum	Read only	0309 (777)	1
Ch5 Units	Units string (up to five characters)	String_5	Read only	030A (778)	3
Spare				030D (781)	2
Ch5 Open string	Open Digital Input string (up to eight characters)	String_8	Read only	030F (783)	4
Spare				0313 (787)	4
Ch5 Close string	Closed Digital Input string (up to eight characters)	String_8	Read only	0317 (791)	4
Spare				031B (795)	4
Ch5 Descriptor	Channel descriptor (up to 20 characters)	String_20	Read only	031F (799)	10
Spare				0329 (809)	10
Ch5 No of alarms	Number of alarms on this channel (0 to 2)	Uint16	Read only	0333 (819)	1
Ch5 PV format	0 = Numeric 1 = Digital strings	Enum	Read only	0334 (820)	1
Spare				0335 (821)	60
Ch5 Alarm 1 enable	Alarm 1 enable 0 = Off 2 = Latched 1 = Unlatched 3 = Trigger	Enum	Read only	0371 (881)	1
Ch5 Alarm 1 type	Alarm 1 type 0 = Absolute low 1 = Absolute high 2 = Deviation in 3 = Deviation out 4 = Rate of change rise 5 = Rate of change fall	Enum	Read only	0372 (882)	1
Ch5 Alarm 1 setpoint	Trigger setpoint (Note 2)	Scaled	Read/Write	0373 (883)	1
Spare				0374 (884)	10
Ch5 Alarm 2 enable	Alarm 2 enable (As alarm 1 enable, above)	Enum	Read only	037E (894)	1
Ch5 Alarm 2 type	Alarm 2 type (As alarm 1 type, above)	Enum	Read only	037F (895)	1
Ch5 Alarm 2 setpoint	Trigger setpoint (Note 2)	Scaled	Read/Write	0380 (896)	1
Spare				0381 (897)	10
Ch5 Alarm 3 enable	Alarm 3 enable (As alarm 1 enable above)	Enum	Read only	02E9 (907)	1
Ch5 Alarm 3 type	Alarm 3 type (As alarm 1 type above)	Enum	Read only	02EA (908)	1
Ch5 Alarm 3 setpoint	Trigger setpoint (Note 2)	Scaled	Read/Write	02EB (909)	1
Spare				02EC (910)	10
Ch5 Alarm 4 enable	Alarm 4 enable (As alarm 1 enable above)	Enum	Read only	02F6 (920)	1
Ch5 Alarm 4 type	Alarm 4 type (As alarm 1 type above)	Enum	Read only	02F7 (921)	1
Ch5 Alarm 4 setpoint	Trigger setpoint (Note 2)	Scaled	Read/Write	02F8 (922)	1
Spare				02F9 (923)	10

Notes

1. For maths, totalisers and counters, see the relevant option description.
2. If an alarm's Setpoint Source ([section 4.3.3](#)) is set to anything other than 'Constant' the value returned will be the previously configured constant value.

8.4.2 CHANNEL CONFIGURATION DATA (Cont.)

CHANNEL 6

Parameter Name	Description	Type	Access	Start Addr. Hex (Dec)	Register Length
Ch6 Span high	Upper span value (display full scale)	Scaled	Read only	03A5 (933)	1
Ch6 Span low	Lower span value (display 'zero')	Scaled	Read only	03A6 (934)	1
Ch6 Zone high	Zone high value (two decimal places)	Scaled	Read only	03A7 (935)	1
Ch6 Zone low	Zone low value (two decimal places)	Scaled	Read only	03A8 (936)	1
Ch6 PV type	Input type 1 = Analogue input 3 = Totaliser 2 = Maths 4 = Counter	Enum	Read only	03A9 (937)	1
Ch6 Decimal places	Number of decimal places (0 to 9) (used by all scaled parameters except where stated)	Uint16	Read only	03AA (938)	1
Ch6 Colour	Channel colour (0 to 55) (See Annex B for RGB definitions)	Enum	Read only	03AB (939)	1
Ch6 Units	Units string (up to five characters)	String_5	Read only	03AC (940)	3
Spare				03AF (943)	2
Ch6 Open string	Open Digital Input string (up to eight characters)	String_8	Read only	03B1 (945)	4
Spare				03B5 (949)	4
Ch6 Close string	Closed Digital Input string (up to eight characters)	String_8	Read only	03B9 (953)	4
Spare				03BD (957)	4
Ch6 Descriptor	Channel descriptor (up to 20 characters)	String_20	Read only	03C1 (961)	10
Spare				03CB (971)	10
Ch6 No of alarms	Number of alarms on this channel (0 to 2)	Uint16	Read only	03D5 (981)	1
Ch6 PV format	0 = Numeric 1 = Digital strings	Enum	Read only	03D6 (982)	1
Spare				03D7 (983)	60
Ch6 Alarm 1 enable	Alarm 1 enable 0 = Off 2 = Latched 1 = Unlatched 3 = Trigger	Enum	Read only	0413 (1043)	1
Ch6 Alarm 1 type	Alarm 1 type 0 = Absolute low 1 = Absolute high 2 = Deviation in 3 = Deviation out 4 = Rate of change rise 5 = Rate of change fall	Enum	Read only	0414 (1044)	1
Ch6 Alarm 1 setpoint	Trigger setpoint (Note 2)	Scaled	Read/Write	0415 (1045)	1
Spare				0416 (1046)	10
Ch6 Alarm 2 enable	Alarm 2 enable (As alarm 1 enable, above)	Enum	Read only	0420 (1056)	1
Ch6 Alarm 2 type	Alarm 2 type (As alarm 1 type, above)	Enum	Read only	0421 (1057)	1
Ch6 Alarm 2 setpoint	Trigger setpoint (Note 2)	Scaled	Read/Write	0422 (1058)	1
Spare				0423 (1059)	10
Ch6 Alarm 3 enable	Alarm 3 enable (As alarm 1 enable above)	Enum	Read only	042D (1069)	1
Ch6 Alarm 3 type	Alarm 3 type (As alarm 1 type above)	Enum	Read only	042E (1070)	1
Ch6 Alarm 3 setpoint	Trigger setpoint (Note 2)	Scaled	Read/Write	042F (1071)	1
Spare				0430 (1072)	10
Ch6 Alarm 4 enable	Alarm 4 enable (As alarm 1 enable above)	Enum	Read only	043A (1082)	1
Ch6 Alarm 4 type	Alarm 4 type (As alarm 1 type above)	Enum	Read only	043B (1083)	1
Ch6 Alarm 4 setpoint	Trigger setpoint (Note 2)	Scaled	Read/Write	043C (1084)	1
Spare				043D (1085)	10

Notes

1. For maths, totalisers and counters, see the relevant option description.
2. If an alarm's Setpoint Source ([section 4.3.3](#)) is set to anything other than 'Constant' the value returned will be the previously configured constant value.

8.4.2 CHANNEL CONFIGURATION DATA (Cont.)

CHANNEL 7

Parameter Name	Description	Type	Access	Start Addr. Hex (Dec)	Register Length
Ch7 Span high	Upper span value (display full scale)	Scaled	Read only	0447 (1095)	1
Ch7 Span low	Lower span value (display 'zero')	Scaled	Read only	0448 (1096)	1
Ch7 Zone high	Zone high value (two decimal places)	Scaled	Read only	0449 (1097)	1
Ch7 Zone low	Zone low value (two decimal places)	Scaled	Read only	044A (1098)	1
Ch7 PV type	Input type 1 = Analogue input 3 = Totaliser 2 = Maths 4 = Counter	Enum	Read only	044B (1099)	1
Ch7 Decimal places	Number of decimal places (0 to 9) (used by all scaled parameters except where stated)	Uint16	Read only	044C (1100)	1
Ch7 Colour	Channel colour (0 to 55) (See Annex B for RGB definitions)	Enum	Read only	044D (1101)	1
Ch7 Units	Units string (up to five characters)	String_5	Read only	044E (1102)	3
Spare				0451 (1105)	2
Ch7 Open string	Open Digital Input string (up to eight characters)	String_8	Read only	0453 (1107)	4
Spare				0457 (1111)	4
Ch7 Close string	Closed Digital Input string (up to eight characters)	String_8	Read only	045B (1115)	4
Spare				045F (1119)	4
Ch7 Descriptor	Channel descriptor (up to 20 characters)	String_20	Read only	0463 (1123)	10
Spare				046D (1133)	10
Ch7 No of alarms	Number of alarms on this channel (0 to 2)	Uint16	Read only	0477 (1143)	1
Ch7 PV format	0 = Numeric 1 = Digital strings	Enum	Read only	0478 (1144)	1
Spare				0479 (1145)	60
Ch7 Alarm 1 enable	Alarm 1 enable 0 = Off 2 = Latched 1 = Unlatched 3 = Trigger	Enum	Read only	04B5 (1205)	1
Ch7 Alarm 1 type	Alarm 1 type 0 = Absolute low 1 = Absolute high 2 = Deviation in 3 = Deviation out 4 = Rate of change rise 5 = Rate of change fall	Enum	Read only	04B6 (1206)	1
Ch7 Alarm 1 setpoint	Trigger setpoint (Note 2)	Scaled	Read/Write	04B7 (1207)	1
Spare				04B8 (1208)	10
Ch7 Alarm 2 enable	Alarm 2 enable (As alarm 1 enable, above)	Enum	Read only	04C2 (1218)	1
Ch7 Alarm 2 type	Alarm 2 type (As alarm 1 type, above)	Enum	Read only	04C3 (1219)	1
Ch7 Alarm 2 setpoint	Trigger setpoint (Note 2)	Scaled	Read/Write	04C4 (1220)	1
Spare				04C5 (1221)	10
Ch7 Alarm 3 enable	Alarm 3 enable (As alarm 1 enable above)	Enum	Read only	04CF (1231)	1
Ch7 Alarm 3 type	Alarm 3 type (As alarm 1 type above)	Enum	Read only	04D0 (1232)	1
Ch7 Alarm 3 setpoint	Trigger setpoint (Note 2)	Scaled	Read/Write	04D1 (1233)	1
Spare				04D2 (1234)	10
Ch7 Alarm 4 enable	Alarm 4 enable (As alarm 1 enable above)	Enum	Read only	04DC (1244)	1
Ch7 Alarm 4 type	Alarm 4 type (As alarm 1 type above)	Enum	Read only	04DD (1245)	1
Ch7 Alarm 4 setpoint	Trigger setpoint (Note 2)	Scaled	Read/Write	04DE (1246)	1
Spare				04DF (1247)	10

Notes

1. For maths, totalisers and counters, see the relevant option description.
2. If an alarm's Setpoint Source ([section 4.3.3](#)) is set to anything other than 'Constant' the value returned will be the previously configured constant value.

8.4.2 CHANNEL CONFIGURATION DATA (Cont.)

CHANNEL 8

Parameter Name	Description	Type	Access	Start Addr. Hex (Dec)	Register Length
Ch8 Span high	Upper span value (display full scale)	Scaled	Read only	04E9 (1257)	1
Ch8 Span low	Lower span value (display 'zero')	Scaled	Read only	04EA (1258)	1
Ch8 Zone high	Zone high value (two decimal places)	Scaled	Read only	04EB (1259)	1
Ch8 Zone low	Zone low value (two decimal places)	Scaled	Read only	04EC (1260)	1
Ch8 PV type	Input type 1 = Analogue input 3 = Totaliser 2 = Maths 4 = Counter	Enum	Read only	04ED (1261)	1
Ch8 Decimal places	Number of decimal places (0 to 9) (used by all scaled parameters except where stated)	Uint16	Read only	04EE (1262)	1
Ch8 Colour	Channel colour (0 to 55) (See Annex B for RGB definitions)	Enum	Read only	04EF (1263)	1
Ch8 Units	Units string (up to five characters)	String_5	Read only	04F0 (1264)	3
Spare				04F3 (1267)	2
Ch8 Open string	Open Digital Input string (up to eight characters)	String_8	Read only	04F5 (1269)	4
Spare				04F9 (1273)	4
Ch8 Close string	Closed Digital Input string (up to eight characters)	String_8	Read only	04FD (1277)	4
Spare				0501 (1281)	4
Ch8 Descriptor	Channel descriptor (up to 20 characters)	String_20	Read only	0505 (1285)	10
Spare				050F (1295)	10
Ch8 No of alarms	Number of alarms on this channel (0 to 2)	Uint16	Read only	0519 (1305)	1
Ch8 PV format	0 = Numeric 1 = Digital strings	Enum	Read only	051A (1306)	1
Spare				051B (1307)	60
Ch8 Alarm 1 enable	Alarm 1 enable 0 = Off 2 = Latched 1 = Unlatched 3 = Trigger	Enum	Read only	0557 (1367)	1
Ch8 Alarm 1 type	Alarm 1 type 0 = Absolute low 1 = Absolute high 2 = Deviation in 3 = Deviation out 4 = Rate of change rise 5 = Rate of change fall	Enum	Read only	0558 (1368)	1
Ch8 Alarm 1 setpoint	Trigger setpoint (Note 2)	Scaled	Read/Write	0559 (1369)	1
Spare				055A (1370)	10
Ch8 Alarm 2 enable	Alarm 2 enable (As alarm 1 enable, above)	Enum	Read only	0564 (1380)	1
Ch8 Alarm 2 type	Alarm 2 type (As alarm 1 type, above)	Enum	Read only	0565 (1381)	1
Ch8 Alarm 2 setpoint	Trigger setpoint (Note 2)	Scaled	Read/Write	0566 (1382)	1
Spare				0567 (1383)	10
Ch8 Alarm 3 enable	Alarm 3 enable (As alarm 1 enable above)	Enum	Read only	0571(1393)	1
Ch8 Alarm 3 type	Alarm 3 type (As alarm 1 type above)	Enum	Read only	0572 (1394)	1
Ch8 Alarm 3 setpoint	Trigger setpoint (Note 2)	Scaled	Read/Write	0573 (1395)	1
Spare				0574 (1396)	10
Ch8 Alarm 4 enable	Alarm 4 enable (As alarm 1 enable above)	Enum	Read only	057E (1406)	1
Ch8 Alarm 4 type	Alarm 4 type (As alarm 1 type above)	Enum	Read only	057F (1407)	1
Ch8 Alarm 4 setpoint	Trigger setpoint (Note 2)	Scaled	Read/Write	0580 (1408)	1
Spare				0581 (1409)	10

Notes

1. For maths, totalisers and counters, see the relevant option description.
2. If an alarm's Setpoint Source ([section 4.3.3](#)) is set to anything other than 'Constant' the value returned will be the previously configured constant value.

8.4.2 CHANNEL CONFIGURATION DATA (Cont.)

CHANNEL 9

Parameter Name	Description	Type	Access	Start Addr. Hex (Dec)	Register Length
Ch9 Span high	Upper span value (display full scale)	Scaled	Read only	058B (1419)	1
Ch9 Span low	Lower span value (display 'zero')	Scaled	Read only	058C (1420)	1
Ch9 Zone high	Zone high value (two decimal places)	Scaled	Read only	058D (1421)	1
Ch9 Zone low	Zone low value (two decimal places)	Scaled	Read only	058E (1422)	1
Ch9 PV type	Input type 1 = Analogue input 3 = Totaliser 2 = Maths 4 = Counter	Enum	Read only	058F (1423)	1
Ch9 Decimal places	Number of decimal places (0 to 9) (used by all scaled parameters except where stated)	Uint16	Read only	0590 (1424)	1
Ch9 Colour	Channel colour (0 to 55) (See Annex B for RGB definitions)	Enum	Read only	0591 (1425)	1
Ch9 Units	Units string (up to five characters)	String_5	Read only	0592 (1426)	3
Spare				0595 (1429)	2
Ch9 Open string	Open Digital Input string (up to eight characters)	String_8	Read only	0597 (1431)	4
Spare				059B (1435)	4
Ch9 Close string	Closed Digital Input string (up to eight characters)	String_8	Read only	059F (1439)	4
Spare				05A3 (1443)	4
Ch9 Descriptor	Channel descriptor (up to 20 characters)	String_20	Read only	05A7 (1447)	10
Spare				05B1 (1457)	10
Ch9 No of alarms	Number of alarms on this channel (0 to 2)	Uint16	Read only	05BB (1467)	1
Ch9 PV format	0 = Numeric 1 = Digital strings	Enum	Read only	05BC (1468)	1
Spare				05BD (1469)	60
Ch9 Alarm 1 enable	Alarm 1 enable 0 = Off 2 = Latched 1 = Unlatched 3 = Trigger	Enum	Read only	05F9 (1529)	1
Ch9 Alarm 1 type	Alarm 1 type 0 = Absolute low 1 = Absolute high 2 = Deviation in 3 = Deviation out 4 = Rate of change rise 5 = Rate of change fall	Enum	Read only	05FA (1530)	1
Ch9 Alarm 1 setpoint	Trigger setpoint (Note 2)	Scaled	Read/Write	05FB (1531)	1
Spare				05FC (1532)	10
Ch9 Alarm 2 enable	Alarm 2 enable (As alarm 1 enable, above)	Enum	Read only	0606 (1542)	1
Ch9 Alarm 2 type	Alarm 2 type (As alarm 1 type, above)	Enum	Read only	0607 (1543)	1
Ch9 Alarm 2 setpoint	Trigger setpoint (Note 2)	Scaled	Read/Write	0608 (1544)	1
Spare				0609 (1545)	10
Ch9 Alarm 3 enable	Alarm 3 enable (As alarm 1 enable above)	Enum	Read only	0613(1555)	1
Ch9 Alarm 3 type	Alarm 3 type (As alarm 1 type above)	Enum	Read only	0614 (1556)	1
Ch9 Alarm 3 setpoint	Trigger setpoint (Note 2)	Scaled	Read/Write	0615 (1557)	1
Spare				0616 (1558)	10
Ch9 Alarm 4 enable	Alarm 4 enable (As alarm 1 enable above)	Enum	Read only	0620 (1568)	1
Ch9 Alarm 4 type	Alarm 4 type (As alarm 1 type above)	Enum	Read only	0621 (1569)	1
Ch9 Alarm 4 setpoint	Trigger setpoint (Note 2)	Scaled	Read/Write	0622 (1570)	1
Spare				0623 (1571)	10

Notes

1. For maths, totalisers and counters, see the relevant option description.
2. If an alarm's Setpoint Source ([section 4.3.3](#)) is set to anything other than 'Constant' the value returned will be the previously configured constant value.

8.4.2 CHANNEL CONFIGURATION DATA (Cont.)

CHANNEL 10

Parameter Name	Description	Type	Access	Start Addr. Hex (Dec)	Register Length
Ch10 Span high	Upper span value (display full scale)	Scaled	Read only	062D (1581)	1
Ch10 Span low	Lower span value (display 'zero')	Scaled	Read only	062E (1582)	1
Ch10 Zone high	Zone high value (two decimal places)	Scaled	Read only	062F (1583)	1
Ch10 Zone low	Zone low value (two decimal places)	Scaled	Read only	0630 (1584)	1
Ch10 PV type	Input type 1 = Analogue input 3 = Totaliser 2 = Maths 4 = Counter	Enum	Read only	0631 (1585)	1
Ch10 Decimal places	Number of decimal places (0 to 9) (used by all scaled parameters except where stated)	Uint16	Read only	0632 (1586)	1
Ch10 Colour	Channel colour (0 to 55) (See Annex B for RGB definitions)	Enum	Read only	0633 (1587)	1
Ch10 Units	Units string (up to five characters)	String_5	Read only	0634 (1588)	3
Spare				0637 (1591)	2
Ch10 Open string	Open Digital Input string (up to eight characters)	String_8	Read only	0639 (1593)	4
Spare				063D (1597)	4
Ch10 Close string	Closed Digital Input string (up to eight characters)	String_8	Read only	0641 (1601)	4
Spare				0645 (1605)	4
Ch10 Descriptor	Channel descriptor (up to 20 characters)	String_20	Read only	0649 (1609)	10
Spare				0653 (1619)	10
Ch10 No of alarms	Number of alarms on this channel (0 to 2)	Uint16	Read only	065D (1629)	1
Ch10 PV format	0 = Numeric 1 = Digital strings	Enum	Read only	065E (1630)	1
Spare				065F (1631)	60
Ch10 Alarm 1 enable	Alarm 1 enable 0 = Off 2 = Latched 1 = Unlatched 3 = Trigger	Enum	Read only	069B (1691)	1
Ch10 Alarm 1 type	Alarm 1 type 0 = Absolute low 1 = Absolute high 2 = Deviation in 3 = Deviation out 4 = Rate of change rise	Enum	Read only	069C (1692)	1
Ch10 Alarm 1 setpoint	Trigger setpoint (Note 2)	Scaled	Read/Write	069D (1693)	1
Spare				069E (1694)	10
Ch10 Alarm 2 enable	Alarm 2 enable (As alarm 1 enable, above)	Enum	Read only	06A8 (1704)	1
Ch10 Alarm 2 type	Alarm 2 type (As alarm 1 type, above)	Enum	Read only	06A9 (1705)	1
Ch10 Alarm 2 setpoint	Trigger setpoint (Note 2)	Scaled	Read/Write	06AA (1706)	1
Spare				06AB (1707)	10
Ch10 Alarm 3 enable	Alarm 3 enable (As alarm 1 enable above)	Enum	Read only	06B5(1717)	1
Ch10 Alarm 3 type	Alarm 3 type (As alarm 1 type above)	Enum	Read only	06B6(1718)	1
Ch10 Alarm 3 setpoint	Trigger setpoint (Note 2)	Scaled	Read/Write	06B7 (1719)	1
Spare				06B8 (1720)	10
Ch10 Alarm 4 enable	Alarm 4 enable (As alarm 1 enable above)	Enum	Read only	06C2 (1730)	1
Ch10 Alarm 4 type	Alarm 4 type (As alarm 1 type above)	Enum	Read only	06C3 (1731)	1
Ch10 Alarm 4 setpoint	Trigger setpoint (Note 2)	Scaled	Read/Write	06C4 (1732)	1
Spare				06C5 (1733)	10

Notes

1. For maths, totalisers and counters, see the relevant option description.
2. If an alarm's Setpoint Source ([section 4.3.3](#)) is set to anything other than 'Constant' the value returned will be the previously configured constant value.

8.4.2 CHANNEL CONFIGURATION DATA (Cont.)

CHANNEL 11

Parameter Name	Description	Type	Access	Start Addr. Hex (Dec)	Register Length
Ch11 Span high	Upper span value (display full scale)	Scaled	Read only	06CF (1743)	1
Ch11 Span low	Lower span value (display 'zero')	Scaled	Read only	06D0 (1744)	1
Ch11 Zone high	Zone high value (two decimal places)	Scaled	Read only	06D1 (1745)	1
Ch11 Zone low	Zone low value (two decimal places)	Scaled	Read only	06D2 (1746)	1
Ch11 PV type	Input type 1 = Analogue input 3 = Totaliser 2 = Maths 4 = Counter	Enum	Read only	06D3 (1747)	1
Ch11 Decimal places	Number of decimal places (0 to 9) (used by all scaled parameters except where stated)	Uint16	Read only	06D4 (1748)	1
Ch11 Colour	Channel colour (0 to 55) (See Annex B for RGB definitions)	Enum	Read only	06D5 (1749)	1
Ch11 Units	Units string (up to five characters)	String_5	Read only	06D6 (1750)	3
Spare				06D9 (1753)	2
Ch11 Open string	Open Digital Input string (up to eight characters)	String_8	Read only	06DB (1755)	4
Spare				06DF (1759)	4
Ch11 Close string	Closed Digital Input string (up to eight characters)	String_8	Read only	06E3 (1763)	4
Spare				06E7 (1767)	4
Ch11 Descriptor	Channel descriptor (up to 20 characters)	String_20	Read only	06EB (1771)	10
Spare				06F5 (1781)	10
Ch11 No of alarms	Number of alarms on this channel (0 to 2)	Uint16	Read only	06FF (1791)	1
Ch11 PV format	0 = Numeric 1 = Digital strings	Enum	Read only	0700 (1792)	1
Spare				0701 (1793)	60
Ch11 Alarm 1 enable	Alarm 1 enable 0 = Off 2 = Latched 1 = Unlatched 3 = Trigger	Enum	Read only	073D (1853)	1
Ch11 Alarm 1 type	Alarm 1 type 0 = Absolute low 1 = Absolute high 2 = Deviation in 3 = Deviation out 4 = Rate of change rise 5 = Rate of change fall	Enum	Read only	073E (1854)	1
Ch11 Alarm 1 setpoint	Trigger setpoint (Note 2)	Scaled	Read/Write	073F (1855)	1
Spare				0740 (1856)	10
Ch11 Alarm 2 enable	Alarm 2 enable (As alarm 1 enable, above)	Enum	Read only	074A (1866)	1
Ch11 Alarm 2 type	Alarm 2 type (As alarm 1 type, above)	Enum	Read only	074B (1867)	1
Ch11 Alarm 2 setpoint	Trigger setpoint (Note 2)	Scaled	Read/Write	074C (1868)	1
Spare				074D (1869)	10
Ch11 Alarm 3 enable	Alarm 3 enable (As alarm 1 enable above)	Enum	Read only	0757(1879)	1
Ch11 Alarm 3 type	Alarm 3 type (As alarm 1 type above)	Enum	Read only	0758 (1880)	1
Ch11 Alarm 3 setpoint	Trigger setpoint (Note 2)	Scaled	Read/Write	0759 (1881)	1
Spare				075A (1882)	10
Ch11 Alarm 4 enable	Alarm 4 enable (As alarm 1 enable above)	Enum	Read only	0764 (1892)	1
Ch11 Alarm 4 type	Alarm 4 type (As alarm 1 type above)	Enum	Read only	0765 (1893)	1
Ch11 Alarm 4 setpoint	Trigger setpoint (Note 2)	Scaled	Read/Write	0766 (1894)	1
Spare				0767 (1895)	10

Notes

1. For maths, totalisers and counters, see the relevant option description.
2. If an alarm's Setpoint Source ([section 4.3.3](#)) is set to anything other than 'Constant' the value returned will be the previously configured constant value.

8.4.2 CHANNEL CONFIGURATION DATA (Cont.)

CHANNEL 12

Parameter Name	Description	Type	Access	Start Addr. Hex (Dec)	Register Length
Ch12 Span high	Upper span value (display full scale)	Scaled	Read only	0771 (1905)	1
Ch12 Span low	Lower span value (display 'zero')	Scaled	Read only	0772 (1906)	1
Ch12 Zone high	Zone high value (two decimal places)	Scaled	Read only	0773 (1907)	1
Ch12 Zone low	Zone low value (two decimal places)	Scaled	Read only	0774 (1908)	1
Ch12 PV type	Input type 1 = Analogue input 3 = Totaliser 2 = Maths 4 = Counter	Enum	Read only	0775 (1909)	1
Ch12 Decimal places	Number of decimal places (0 to 9) (used by all scaled parameters except where stated)	Uint16	Read only	0776 (1910)	1
Ch12 Colour	Channel colour (0 to 55) (See Annex B for RGB definitions)	Enum	Read only	0777 (1911)	1
Ch12 Units	Units string (up to five characters)	String_5	Read only	0778 (1912)	3
Spare				077B (1915)	2
Ch12 Open string	Open Digital Input string (up to eight characters)	String_8	Read only	077D (1917)	4
Spare				0781 (1921)	4
Ch12 Close string	Closed Digital Input string (up to eight characters)	String_8	Read only	0785 (1925)	4
Spare				0789 (1929)	4
Ch12 Descriptor	Channel descriptor (up to 20 characters)	String_20	Read only	078D (1933)	10
Spare				0797 (1943)	10
Ch12 No of alarms	Number of alarms on this channel (0 to 2)	Uint16	Read only	07A1 (1953)	1
Ch12 PV format	0 = Numeric 1 = Digital strings	Enum	Read only	07A2 (1954)	1
Spare				07A3 (1955)	60
Ch12 Alarm 1 enable	Alarm 1 enable 0 = Off 2 = Latched 1 = Unlatched 3 = Trigger	Enum	Read only	07DF (2015)	1
Ch12 Alarm 1 type	Alarm 1 type 0 = Absolute low 1 = Absolute high 2 = Deviation in 3 = Deviation out 4 = Rate of change rise 5 = Rate of change fall	Enum	Read only	07E0 (2016)	1
Ch12 Alarm 1 setpoint	Trigger setpoint (Note 2)	Scaled	Read/Write	07E1 (2017)	1
Spare				07E2 (2018)	10
Ch12 Alarm 2 enable	Alarm 2 enable (As alarm 1 enable, above)	Enum	Read only	07EC (2028)	1
Ch12 Alarm 2 type	Alarm 2 type (As alarm 1 type, above)	Enum	Read only	07ED (2029)	1
Ch12 Alarm 2 setpoint	Trigger setpoint (Note 2)	Scaled	Read/Write	07EE (2030)	1
Spare				07EF (2031)	10
Ch12 Alarm 3 enable	Alarm 3 enable (As alarm 1 enable above)	Enum	Read only	07F9 (2041)	1
Ch12 Alarm 3 type	Alarm 3 type (As alarm 1 type above)	Enum	Read only	07FA (2042)	1
Ch12 Alarm 3 setpoint	Trigger setpoint (Note 2)	Scaled	Read/Write	07FB (2043)	1
Spare				07FC (2044)	10
Ch12 Alarm 4 enable	Alarm 4 enable (As alarm 1 enable above)	Enum	Read only	0806 (2054)	1
Ch12 Alarm 4 type	Alarm 4 type (As alarm 1 type above)	Enum	Read only	0807 (2055)	1
Ch12 Alarm 4 setpoint	Trigger setpoint (Note 2)	Scaled	Read/Write	0808 (2056)	1
Spare				0809 (2057)	10

Notes

1. For maths, totalisers and counters, see the relevant option description.
2. If an alarm's Setpoint Source ([section 4.3.3](#)) is set to anything other than 'Constant' the value returned will be the previously configured constant value.

8.4.3 Channel Run-Time data

These tables show addresses for channel input values for channels 1 to 12 inclusive.

Generally: channel N address = channel 1 address + 3(N-1) (decimal). For channels 75 to 100 (Ethernet/IP option only), see [table 4.3.21](#).

CHANNEL 1

Parameter Name	Description	Type	Access	Start Addr. Hex (Dec)	Register Length
Ch1 value	Current process value (PV)	Scaled	See note 1	A1D9 (41433)	1
Ch1 status	Channel status 0 = Good PV 5 = Ranging error 1 = Channel off 6 = Overflow 2 = Over range 7 = Bad PV 3 = Under range 8 = No data 4 = Hardware error	Enum	Read only	A1DA (41434)	1
Ch1 Alarms	Alarm information Bit 0: 0 = Alarm 1 inactive; 1 = Alarm 1 active Bit 1: 0 = No alarm 1 Ack. required; 1 = Ack. required Bit 2: 1 = Acknowledge alarm 1 Bit 3: Spare Bit 4: 0 = Alarm 2 inactive; 1 = Alarm 2 active Bit 5: 0 = No Alarm 2 Ack. required; 1 = Ack. required Bit 6: 1 = Acknowledge alarm 2 Bit 7: Spare Bit 8: 0 = Alarm 3 inactive; 1 = Alarm 3 active Bit 9: 0 = No alarm 3 Ack. required; 1 = Ack. required Bit 10: 1 = Acknowledge alarm 3 Bit 11: Spare Bit 12: 0 = Alarm 4 inactive; 1 = Alarm 4 active Bit 13: 0 = No Alarm 4 Ack. required; 1 = Ack. required Bit 14: 1 = Acknowledge alarm 4 Bit 15: Spare	Uint16	- Read only Read only Read/Write Read only Read only Read/Write Read only Read only Read/Write	A1DB (41435)	1

CHANNEL 2

Parameter Name	Description	Type	Access	Start Addr. Hex (Dec)	Register Length
Ch2 value	Current process value (PV)	Scaled	See note 1	A1DC (41436)	1
Ch2 status	Channel status 0 = Good PV 5 = Ranging error 1 = Channel off 6 = Overflow 2 = Over range 7 = Bad PV 3 = Under range 8 = No data 4 = Hardware error	Enum	Read only	A1DD (41437)	1
Ch2 Alarms	Alarm information Bit 0: 0 = Alarm 1 inactive; 1 = Alarm 1 active Bit 1: 0 = No alarm 1 Ack. required; 1 = Ack. required Bit 2: 1 = Acknowledge alarm 1 Bit 3: Spare Bit 4: 0 = Alarm 2 inactive; 1 = Alarm 2 active Bit 5: 0 = No Alarm 2 Ack. required; 1 = Ack. required Bit 6: 1 = Acknowledge alarm 2 Bit 7: Spare Bit 8: 0 = Alarm 3 inactive; 1 = Alarm 3 active Bit 9: 0 = No alarm 3 Ack. required; 1 = Ack. required Bit 10: 1 = Acknowledge alarm 3 Bit 11: Spare Bit 12: 0 = Alarm 4 inactive; 1 = Alarm 4 active Bit 13: 0 = No Alarm 4 Ack. required; 1 = Ack. required Bit 14: 1 = Acknowledge alarm 4 Bit 15: Spare	Uint16	- Read only Read only Read/Write Read only Read only Read/Write Read only Read only Read/Write	A1DE (41438)	1

Note: PV access is Read/Write for any point configured with 'Slave Comms' as its Type or Function. Otherwise PV access is Read only.

8.4.3 CHANNEL RUN TIME DATA (Cont.)

CHANNEL 3

Parameter Name	Description	Type	Access	Start Addr. Hex (Dec)	Register Length
Ch3 value	Current process value (PV)	Scaled	See note 1	A1DF (41439)	1
Ch3 status	Channel status	Enum	Read only	A1E0 (41440)	1
	0 = Good PV 5 = Ranging error 1 = Channel off 6 = Overflow 2 = Over range 7 = Bad PV 3 = Under range 8 = No data 4 = Hardware error				
Ch3 Alarms	Alarm information	Uint16	-	A1E1 (41441)	1
	Bit 0: 0 = Alarm 1 inactive; 1 = Alarm 1 active Bit 1: 0 = No alarm 1 Ack. required; 1 = Ack. required Bit 2: 1 = Acknowledge alarm 1 Bit 3: Spare Bit 4: 0 = Alarm 2 inactive; 1 = Alarm 2 active Bit 5: 0 = No Alarm 2 Ack. required; 1 = Ack. required Bit 6: 1 = Acknowledge alarm 2 Bit 7: Spare Bit 8: 0 = Alarm 3 inactive; 1 = Alarm 3 active Bit 9: 0 = No alarm 3 Ack. required; 1 = Ack. required Bit 10: 1 = Acknowledge alarm 3 Bit 11: Spare Bit 12: 0 = Alarm 4 inactive; 1 = Alarm 4 active Bit 13: 0 = No Alarm 4 Ack. required; 1 = Ack. required Bit 14: 1 = Acknowledge alarm 4 Bit 15: Spare		Read only Read only Read/Write Read only Read only Read/Write Read only Read only Read/Write Read only Read only Read/Write		

CHANNEL 4

Parameter Name	Description	Type	Access	Start Addr. Hex (Dec)	Register Length
Ch4 value	Current process value (PV)	Scaled	See note 1	A1E2 (41442)	1
Ch4 status	Channel status	Enum	Read only	A1E3 (41443)	1
	0 = Good PV 5 = Ranging error 1 = Channel off 6 = Overflow 2 = Over range 7 = Bad PV 3 = Under range 8 = No data 4 = Hardware error				
Ch4 Alarms	Alarm information	Uint16	-	A1E4 (41444)	1
	Bit 0: 0 = Alarm 1 inactive; 1 = Alarm 1 active Bit 1: 0 = No alarm 1 Ack. required; 1 = Ack. required Bit 2: 1 = Acknowledge alarm 1 Bit 3: Spare Bit 4: 0 = Alarm 2 inactive; 1 = Alarm 2 active Bit 5: 0 = No Alarm 2 Ack. required; 1 = Ack. required Bit 6: 1 = Acknowledge alarm 2 Bit 7: Spare Bit 8: 0 = Alarm 3 inactive; 1 = Alarm 3 active Bit 9: 0 = No alarm 3 Ack. required; 1 = Ack. required Bit 10: 1 = Acknowledge alarm 3 Bit 11: Spare Bit 12: 0 = Alarm 4 inactive; 1 = Alarm 4 active Bit 13: 0 = No Alarm 4 Ack. required; 1 = Ack. required Bit 14: 1 = Acknowledge alarm 4 Bit 15: Spare		Read only Read only Read/Write Read only Read only Read/Write Read only Read only Read/Write		

Note: PV access is Read/Write for any point configured with 'Slave Comms' as its Type or Function. Otherwise PV access is Read only.

8.4.3 CHANNEL RUN TIME DATA (Cont.)

CHANNEL 5

Parameter Name	Description	Type	Access	Start Addr. Hex (Dec)	Register Length
Ch5 value	Current process value (PV)	Scaled	See note 1	A1E5 (41445)	1
Ch5 status	Channel status	Enum	Read only	A1E6 (41446)	1
	0 = Good PV 5 = Ranging error 1 = Channel off 6 = Overflow 2 = Over range 7 = Bad PV 3 = Under range 8 = No data 4 = Hardware error				
Ch5 Alarms	Alarm information	Uint16	-	A1E7 (41447)	1
	Bit 0: 0 = Alarm 1 inactive; 1 = Alarm 1 active Bit 1: 0 = No alarm 1 Ack. required; 1 = Ack. required Bit 2: 1 = Acknowledge alarm 1 Bit 3: Spare Bit 4: 0 = Alarm 2 inactive; 1 = Alarm 2 active Bit 5: 0 = No Alarm 2 Ack. required; 1 = Ack. required Bit 6: 1 = Acknowledge alarm 2 Bit 7: Spare Bit 8: 0 = Alarm 3 inactive; 1 = Alarm 3 active Bit 9: 0 = No alarm 3 Ack. required; 1 = Ack. required Bit 10: 1 = Acknowledge alarm 3 Bit 11: Spare Bit 12: 0 = Alarm 4 inactive; 1 = Alarm 4 active Bit 13: 0 = No Alarm 4 Ack. required; 1 = Ack. required Bit 14: 1 = Acknowledge alarm 4 Bit 15: Spare		Read only Read only Read/Write Read only Read only Read/Write Read only Read only Read/Write Read only Read only Read/Write		

CHANNEL 6

Parameter Name	Description	Type	Access	Start Addr. Hex (Dec)	Register Length
Ch6 value	Current process value (PV)	Scaled	See note 1	A1E8 (41448)	1
Ch6 status	Channel status	Enum	Read only	A1E9 (41449)	1
	0 = Good PV 5 = Ranging error 1 = Channel off 6 = Overflow 2 = Over range 7 = Bad PV 3 = Under range 8 = No data 4 = Hardware error				
Ch6 Alarms	Alarm information	Uint16	-	A1EA (41450)	1
	Bit 0: 0 = Alarm 1 inactive; 1 = Alarm 1 active Bit 1: 0 = No alarm 1 Ack. required; 1 = Ack. required Bit 2: 1 = Acknowledge alarm 1 Bit 3: Spare Bit 4: 0 = Alarm 2 inactive; 1 = Alarm 2 active Bit 5: 0 = No Alarm 2 Ack. required; 1 = Ack. required Bit 6: 1 = Acknowledge alarm 2 Bit 7: Spare Bit 8: 0 = Alarm 3 inactive; 1 = Alarm 3 active Bit 9: 0 = No alarm 3 Ack. required; 1 = Ack. required Bit 10: 1 = Acknowledge alarm 3 Bit 11: Spare Bit 12: 0 = Alarm 4 inactive; 1 = Alarm 4 active Bit 13: 0 = No Alarm 4 Ack. required; 1 = Ack. required Bit 14: 1 = Acknowledge alarm 4 Bit 15: Spare		Read only Read only Read/Write Read only Read only Read/Write Read only Read only Read/Write		

Note: PV access is Read/Write for any point configured with 'Slave Comms' as its Type or Function. Otherwise PV access is Read only.

8.4.3 CHANNEL RUN TIME DATA (Cont.)

CHANNEL 7

Parameter Name	Description	Type	Access	Start Addr. Hex (Dec)	Register Length
Ch7 value	Current process value (PV)	Scaled	See note 1	A1EB (41451)	1
Ch7 status	Channel status	Enum	Read only	A1EC (41452)	1
	0 = Good PV 5 = Ranging error 1 = Channel off 6 = Overflow 2 = Over range 7 = Bad PV 3 = Under range 8 = No data 4 = Hardware error				
Ch7 Alarms	Alarm information	Uint16	-	A1ED (41453)	1
	Bit 0: 0 = Alarm 1 inactive; 1 = Alarm 1 active Bit 1: 0 = No alarm 1 Ack. required; 1 = Ack. required Bit 2: 1 = Acknowledge alarm 1 Bit 3: Spare Bit 4: 0 = Alarm 2 inactive; 1 = Alarm 2 active Bit 5: 0 = No Alarm 2 Ack. required; 1 = Ack. required Bit 6: 1 = Acknowledge alarm 2 Bit 7: Spare Bit 8: 0 = Alarm 3 inactive; 1 = Alarm 3 active Bit 9: 0 = No alarm 3 Ack. required; 1 = Ack. required Bit 10: 1 = Acknowledge alarm 3 Bit 11: Spare Bit 12: 0 = Alarm 4 inactive; 1 = Alarm 4 active Bit 13: 0 = No Alarm 4 Ack. required; 1 = Ack. required Bit 14: 1 = Acknowledge alarm 4 Bit 15: Spare		Read only Read only Read/Write Read only Read only Read/Write Read only Read only Read/Write Read only Read only Read/Write		

CHANNEL 8

Parameter Name	Description	Type	Access	Start Addr. Hex (Dec)	Register Length
Ch8 value	Current process value (PV)	Scaled	See note 1	A1EE (41454)	1
Ch8 status	Channel status	Enum	Read only	A1EF (41455)	1
	0 = Good PV 5 = Ranging error 1 = Channel off 6 = Overflow 2 = Over range 7 = Bad PV 3 = Under range 8 = No data 4 = Hardware error				
Ch8 Alarms	Alarm information	Uint16	-	A1F0 (41456)	1
	Bit 0: 0 = Alarm 1 inactive; 1 = Alarm 1 active Bit 1: 0 = No alarm 1 Ack. required; 1 = Ack. required Bit 2: 1 = Acknowledge alarm 1 Bit 3: Spare Bit 4: 0 = Alarm 2 inactive; 1 = Alarm 2 active Bit 5: 0 = No Alarm 2 Ack. required; 1 = Ack. required Bit 6: 1 = Acknowledge alarm 2 Bit 7: Spare Bit 8: 0 = Alarm 3 inactive; 1 = Alarm 3 active Bit 9: 0 = No alarm 3 Ack. required; 1 = Ack. required Bit 10: 1 = Acknowledge alarm 3 Bit 11: Spare Bit 12: 0 = Alarm 4 inactive; 1 = Alarm 4 active Bit 13: 0 = No Alarm 4 Ack. required; 1 = Ack. required Bit 14: 1 = Acknowledge alarm 4 Bit 15: Spare		Read only Read only Read/Write Read only Read only Read/Write Read only Read only Read/Write		

Note: PV access is Read/Write for any point configured with 'Slave Comms' as its Type or Function. Otherwise PV access is Read only.

8.4.3 CHANNEL RUN TIME DATA (Cont.)

CHANNEL 9

Parameter Name	Description	Type	Access	Start Addr. Hex (Dec)	Register Length
Ch9 value	Current process value (PV)	Scaled	See note 1	A1F1 (41457)	1
Ch9 status	Channel status	Enum	Read only	A1F2 (41458)	1
	0 = Good PV 5 = Ranging error 1 = Channel off 6 = Overflow 2 = Over range 7 = Bad PV 3 = Under range 8 = No data 4 = Hardware error				
Ch9 Alarms	Alarm information	Uint16	-	A1F3 (41459)	1
	Bit 0: 0 = Alarm 1 inactive; 1 = Alarm 1 active Bit 1: 0 = No alarm 1 Ack. required; 1 = Ack. required Bit 2: 1 = Acknowledge alarm 1 Bit 3: Spare Bit 4: 0 = Alarm 2 inactive; 1 = Alarm 2 active Bit 5: 0 = No Alarm 2 Ack. required; 1 = Ack. required Bit 6: 1 = Acknowledge alarm 2 Bit 7: Spare Bit 8: 0 = Alarm 3 inactive; 1 = Alarm 3 active Bit 9: 0 = No alarm 3 Ack. required; 1 = Ack. required Bit 10: 1 = Acknowledge alarm 3 Bit 11: Spare Bit 12: 0 = Alarm 4 inactive; 1 = Alarm 4 active Bit 13: 0 = No Alarm 4 Ack. required; 1 = Ack. required Bit 14: 1 = Acknowledge alarm 4 Bit 15: Spare		Read only Read only Read/Write Read only Read only Read/Write Read only Read only Read/Write Read only Read only Read/Write		

CHANNEL 10

Parameter Name	Description	Type	Access	Start Addr. Hex (Dec)	Register Length
Ch10 value	Current process value (PV)	Scaled	See note 1	A1F4 (41460)	1
Ch10 status	Channel status	Enum	Read only	A1F5 (41461)	1
	0 = Good PV 5 = Ranging error 1 = Channel off 6 = Overflow 2 = Over range 7 = Bad PV 3 = Under range 8 = No data 4 = Hardware error				
Ch10 Alarms	Alarm information	Uint16	-	A1F6 (41462)	1
	Bit 0: 0 = Alarm 1 inactive; 1 = Alarm 1 active Bit 1: 0 = No alarm 1 Ack. required; 1 = Ack. required Bit 2: 1 = Acknowledge alarm 1 Bit 3: Spare Bit 4: 0 = Alarm 2 inactive; 1 = Alarm 2 active Bit 5: 0 = No Alarm 2 Ack. required; 1 = Ack. required Bit 6: 1 = Acknowledge alarm 2 Bit 7: Spare Bit 8: 0 = Alarm 3 inactive; 1 = Alarm 3 active Bit 9: 0 = No alarm 3 Ack. required; 1 = Ack. required Bit 10: 1 = Acknowledge alarm 3 Bit 11: Spare Bit 12: 0 = Alarm 4 inactive; 1 = Alarm 4 active Bit 13: 0 = No Alarm 4 Ack. required; 1 = Ack. required Bit 14: 1 = Acknowledge alarm 4 Bit 15: Spare		Read only Read only Read/Write Read only Read only Read/Write Read only Read only Read/Write		

Note: PV access is Read/Write for any point configured with 'Slave Comms' as its Type or Function. Otherwise PV access is Read only.

8.4.3 CHANNEL RUN TIME DATA (Cont.)

CHANNEL 11

Parameter Name	Description	Type	Access	Start Addr. Hex (Dec)	Register Length
Ch11 value	Current process value (PV)	Scaled	See note 1	A1F7 (41463)	1
Ch11 status	Channel status	Enum	Read only	A1F8 (41464)	1
	0 = Good PV 5 = Ranging error 1 = Channel off 6 = Overflow 2 = Over range 7 = Bad PV 3 = Under range 8 = No data 4 = Hardware error				
Ch11 Alarms	Alarm information	Uint16	-	A1F9 (41465)	1
	Bit 0: 0 = Alarm 1 inactive; 1 = Alarm 1 active Bit 1: 0 = No alarm 1 Ack. required; 1 = Ack. required Bit 2: 1 = Acknowledge alarm 1 Bit 3: Spare Bit 4: 0 = Alarm 2 inactive; 1 = Alarm 2 active Bit 5: 0 = No Alarm 2 Ack. required; 1 = Ack. required Bit 6: 1 = Acknowledge alarm 2 Bit 7: Spare Bit 8: 0 = Alarm 3 inactive; 1 = Alarm 3 active Bit 9: 0 = No alarm 3 Ack. required; 1 = Ack. required Bit 10: 1 = Acknowledge alarm 3 Bit 11: Spare Bit 12: 0 = Alarm 4 inactive; 1 = Alarm 4 active Bit 13: 0 = No Alarm 4 Ack. required; 1 = Ack. required Bit 14: 1 = Acknowledge alarm 4 Bit 15: Spare		Read only Read only Read/Write Read only Read only Read/Write Read only Read only Read/Write Read only Read only Read/Write		

CHANNEL 12

Parameter Name	Description	Type	Access	Start Addr. Hex (Dec)	Register Length
Ch12 value	Current process value (PV)	Scaled	See note 1	A1FA (41466)	1
Ch12 status	Channel status	Enum	Read only	A1FB (41467)	1
	0 = Good PV 5 = Ranging error 1 = Channel off 6 = Overflow 2 = Over range 7 = Bad PV 3 = Under range 8 = No data 4 = Hardware error				
Ch12 Alarms	Alarm information	Uint16	-	A1FC (41468)	1
	Bit 0: 0 = Alarm 1 inactive; 1 = Alarm 1 active Bit 1: 0 = No alarm 1 Ack. required; 1 = Ack. required Bit 2: 1 = Acknowledge alarm 1 Bit 3: Spare Bit 4: 0 = Alarm 2 inactive; 1 = Alarm 2 active Bit 5: 0 = No Alarm 2 Ack. required; 1 = Ack. required Bit 6: 1 = Acknowledge alarm 2 Bit 7: Spare Bit 8: 0 = Alarm 3 inactive; 1 = Alarm 3 active Bit 9: 0 = No alarm 3 Ack. required; 1 = Ack. required Bit 10: 1 = Acknowledge alarm 3 Bit 11: Spare Bit 12: 0 = Alarm 4 inactive; 1 = Alarm 4 active Bit 13: 0 = No Alarm 4 Ack. required; 1 = Ack. required Bit 14: 1 = Acknowledge alarm 4 Bit 15: Spare		Read only Read only Read/Write Read only Read only Read/Write Read only Read only Read/Write		

Note: PV access is Read/Write for any point configured with 'Slave Comms' as its Type or Function. Otherwise PV access is Read only.

8.4.4 Group data

Generally: Parameter address for group N = Parameter address for group 1 + 629(N-1) (decimal)

GROUP 1

Parameter Name	Description	Type	Access	Start Addr. Hex (Dec)	Register Length
Grp1 Trend type	Trend enhancements 0 = Interpolation enabled 1 = Adaptive recording enabled	Enum	Read only	A4D6 (42198)	1
Grp1 Trend rate	Trend update rate in milliseconds	Uint32	Read only	A4D7 (42199)	2
Grp1 Archive rate	Archive (to flash) rate in milliseconds	Uint 32	Read only	A4D9 (42201)	2
Grp1 Descriptor	Group descriptor (20 characters max.)	String_20	Read only	A4DB (42203)	10
Spare				A4E5 (42213)	10
Grp1 Channels in group	16 Registers holding the group contents, as follows: Register 1 Bit 0: 0 = Point 1 not in group; 1 = Point 1 is in group Bit 1: 0 = Point 2 not in group; 1 = Point 2 is in group Bit 2: 0 = Point 3 not in group; 1 = Point 3 is in group Etc. Bit 15: 0 = Point 16 not in group; 1 = Point 16 is in group	Uint16	Read only	A4EF (42223)	(16) 1
See table 8.3 for point types	Register 2 - as register 1, but for points 17 to 32	Uint16	Read only	A4F0 (42224)	1
	Register 3 - as register 1, but for points 33 to 48	Uint16	Read only	A4F1 (42225)	1
	Register 4 - as register 1, but for points 49 to 64	Uint16	Read only	A4F2 (42226)	1
	Register 5 - as register 1, but for points 65 to 80	Uint16	Read only	A4F3 (42227)	1
	Register 6 - as register 1, but for points 81 to 96	Uint16	Read only	A4F4 (42228)	1
	Register 7 - as register 1, but for points 97 to 112	Uint16	Read only	A4F5 (42229)	1
	Register 8 - as register 1, but for points 113 to 128	Uint16	Read only	A4F6 (42230)	1
	Register 9 - as register 1, but for points 129 to 144	Uint16	Read only	A4F7 (42231)	1
	Register 10 - as register 1, but for points 145 to 160	Uint16	Read only	A4F8 (42232)	1
	Register 11 - as register 1, but for points 161 to 176	Uint16	Read only	A4F9 (42233)	1
	Register 12 - as register 1, but for points 177 to 192	Uint16	Read only	A4FA (42234)	1
	Register 13 - as register 1, but for points 193 to 208	Uint16	Read only	A4FB (42235)	1
	Register 14 - as register 1, but for points 209 to 224	Uint16	Read only	A4FC (42236)	1
	Register 15 - as register 1, but for points 225 to 240	Uint16	Read only	A4FD (42237)	1
	Register 16 - as register 1, but for points 241 to 256	Uint16	Read only	A4FE (42238)	1
	Grp1 Text length	Identifies the length of a text message to be read	Uint16	Read/Write	A4FF (42239)
Grp1 Text time stamp	Time stamp of the text message to be read (UTC format)	Double	Read only	A500 (42240)	4
Grp1 Read text	Read text string from instrument display	String_60	Read only	A504 (42244)	30
Reserved				A522 (42274)	30
Grp1 Write text	Write a text string to instrument display	String_60	Write only	A540 (42304)	30
Reserved				A55E (42334)	30
Grp1 Batch start	Boolean Flag. Value 0001 starts new batch	Boolean	Write only	A57C (42364)	1
Grp1 Batch stop	Boolean Flag. Value 0001 stops current batch	Boolean	Write only	A57D (42365)	1
Grp1 Batch running	Batch status flag: 1 = Running; 0 = Not running	Boolean	Read only	A57E (42366)	1
Grp1 Text field 1	Batch field 1 text string (max. 60 characters)	String_60	Read/Write	A57F (42367)	30
Reserved				A59D (42397)	30
Grp1 Text field 2	Batch field 2 text string (max. 60 characters)	String_60	Read/Write	A5BB (42427)	30
Reserved				A5D9 (42457)	30
Grp1 Text field 3	Batch field 3 text string (max. 60 characters)	String_60	Read/Write	A5F7 (42487)	30
Reserved				A615 (42517)	30
Grp1 Text field 4	Batch field 4 text string (max. 60 characters)	String_60	Read/Write	A633 (42547)	30
Reserved				A651 (42577)	30
Grp1 Text field 5	Batch field 5 text string (max. 60 characters)	String_60	Read/Write	A66F (42607)	30
Reserved				A68D (42637)	30
Grp1 Text field 6	Batch field 6 text string (max. 60 characters)	String_60	Read/Write	A6AB (42667)	30
Reserved				A6C9 (42697)	30
Spare				A6E7 (42727)	100

8.4.4 GROUP DATA (Cont.)

GROUP 2

Parameter Name	Description	Type	Access	Start Addr. Hex (Dec)	Register Length
Grp2 Trend type	Trend enhancements 0 = Interpolation enabled 1 = Adaptive recording enabled	Enum	Read only	A74B (42827)	1
Grp2 Trend rate	Trend update rate in milliseconds	UInt32	Read only	A74C (42828)	2
Grp2 Archive rate	Archive (to flash) rate in milliseconds	UInt 32	Read only	A74E (42830)	2
Grp2 Descriptor	Group descriptor (20 characters max.)	String_20	Read only	A750 (42832)	10
Spare				A75A (42842)	10
Grp2 Channels in group	16 Registers holding the group contents, as follows: Register 1 Bit 0: 0 = Point 1 not in group; 1 = Point 1 is in group Bit 1: 0 = Point 2 not in group; 1 = Point 2 is in group Bit 2: 0 = Point 3 not in group; 1 = Point 3 is in group Etc. Bit 15: 0 = Point 16 not in group; 1 = Point 16 is in group	UInt16	Read only	A764 (42852)	(16) 1
See table 8.3 for point types	Register 2 - as register 1, but for points 17 to 32	UInt16	Read only	A765 (42853)	1
	Register 3 - as register 1, but for points 33 to 48	UInt16	Read only	A766 (42854)	1
	Register 4 - as register 1, but for points 49 to 64	UInt16	Read only	A767 (42855)	1
	Register 5 - as register 1, but for points 65 to 80	UInt16	Read only	A768 (42856)	1
	Register 6 - as register 1, but for points 81 to 96	UInt16	Read only	A769 (42857)	1
	Register 7 - as register 1, but for points 97 to 112	UInt16	Read only	A76A(42858)	1
	Register 8 - as register 1, but for points 113 to 128	UInt16	Read only	A76B (42859)	1
	Register 9 - as register 1, but for points 129 to 144	UInt16	Read only	A76C (42860)	1
	Register 10 - as register 1, but for points 145 to 160	UInt16	Read only	A76D (42861)	1
	Register 11 - as register 1, but for points 161 to 176	UInt16	Read only	A76E (42862)	1
	Register 12 - as register 1, but for points 177 to 192	UInt16	Read only	A76F (42863)	1
	Register 13 - as register 1, but for points 193 to 208	UInt16	Read only	A770 (42864)	1
	Register 14 - as register 1, but for points 209 to 224	UInt16	Read only	A771 (42865)	1
	Register 15 - as register 1, but for points 225 to 240	UInt16	Read only	A772 (42866)	1
	Register 16 - as register 1, but for points 241 to 256	UInt16	Read only	A773 (42867)	1
	Grp2 Text length	Identifies the length of a text message to be read	UInt16	Read/Write	A774 (42868)
Grp2 Text time stamp	Time stamp of the text message to be read (UTC format)	Double	Read only	A775 (42869)	4
Grp2 Read text	Read text string from instrument display	String_60	Read only	A779 (42873)	30
Reserved				A797 (42903)	30
Grp2 Write text	Write a text string to instrument display	String_60	Write only	A7B5 (42933)	30
Reserved				A7D3 (42963)	30
Grp2 Batch start	Boolean Flag. Value 0001 starts new batch	Boolean	Write only	A7F1 (42993)	1
Grp2 Batch stop	Boolean Flag. Value 0001 stops current batch	Boolean	Write only	A7F2 (42994)	1
Grp2 Batch running	Batch status flag: 1 = Running; 0 = Not running	Boolean	Read only	A7F3 (42995)	1
Grp2 Text field 1	Batch field 1 text string (max. 60 characters)	String_60	Read/Write	A7F4 (42996)	30
Reserved				A812 (43026)	30
Grp2 Text field 2	Batch field 2 text string (max. 60 characters)	String_60	Read/Write	A830 (43056)	30
Reserved				A84E (43086)	30
Grp2 Text field 3	Batch field 3 text string (max. 60 characters)	String_60	Read/Write	A86C (43116)	30
Reserved				A88A (43146)	30
Grp2 Text field 4	Batch field 4 text string (max. 60 characters)	String_60	Read/Write	A8A8 (43176)	30
Reserved				A8C6 (43206)	30
Grp2 Text field 5	Batch field 5 text string (max. 60 characters)	String_60	Read/Write	A8E4 (43236)	30
Reserved				A902 (43266)	30
Grp2 Text field 6	Batch field 6 text string (max. 60 characters)	String_60	Read/Write	A920 (43296)	30
Reserved				A93E (43326)	30
Spare				A95C (43356)	100

8.4.4 GROUP DATA (Cont.)

GROUP 3

Parameter Name	Description	Type	Access	Start Addr. Hex (Dec)	Register Length
Grp3 Trend type	Trend enhancements Enum 0 = Interpolation enabled 1 = Adaptive recording enabled	Read only	A9C0 (43456)		1
Grp3 Trend rate	Trend update rate in milliseconds	Uint32	Read only	A9C1 (43457)	2
Grp3 Archive rate	Archive (to flash) rate in milliseconds	Uint 32	Read only	A9C3 (43459)	2
Grp3 Descriptor	Group descriptor (20 characters max.)	String_20	Read only	A9C5 (43461)	10
Spare				A9CF (43471)	10
Grp3 Channels in group	16 Registers holding the group contents, as follows: Register 1 Bit 0: 0 = Point 1 not in group; 1 = Point 1 is in group Bit 1: 0 = Point 2 not in group; 1 = Point 2 is in group Bit 2: 0 = Point 3 not in group; 1 = Point 3 is in group Etc. Bit 15: 0 = Point 16 not in group; 1 = Point 16 is in group	Uint16	Read only	A9D9 (43481)	1
See table 8.3 for point types	Register 2 - as register 1, but for points 17 to 32	Uint16	Read only	A9DA (42482)	1
	Register 3 - as register 1, but for points 33 to 48	Uint16	Read only	A9DB (42483)	1
	Register 4 - as register 1, but for points 49 to 64	Uint16	Read only	A9DC (42484)	1
	Register 5 - as register 1, but for points 65 to 80	Uint16	Read only	A9DD (42485)	1
	Register 6 - as register 1, but for points 81 to 96	Uint16	Read only	A9DE (42486)	1
	Register 7 - as register 1, but for points 97 to 112	Uint16	Read only	A9DF (42487)	1
	Register 8 - as register 1, but for points 113 to 128	Uint16	Read only	A9E0 (42488)	1
	Register 9 - as register 1, but for points 129 to 144	Uint16	Read only	A9E1 (42489)	1
	Register 10 - as register 1, but for points 145 to 160	Uint16	Read only	A9E2 (42490)	1
	Register 11 - as register 1, but for points 161 to 176	Uint16	Read only	A9E3 (42491)	1
	Register 12 - as register 1, but for points 177 to 192	Uint16	Read only	A9E4 (42492)	1
	Register 13 - as register 1, but for points 193 to 208	Uint16	Read only	A9E5 (42493)	1
	Register 14 - as register 1, but for points 209 to 224	Uint16	Read only	A9E6 (42494)	1
	Register 15 - as register 1, but for points 225 to 240	Uint16	Read only	A9E7 (42495)	1
	Register 16 - as register 1, but for points 241 to 256	Uint16	Read only	A9E8 (43496)	1
	Grp3 Text length	Identifies the length of a text message to be read	Uint16	Read/Write	A9E9 (43497)
Grp3 Text time stamp	Time stamp of the text message to be read (UTC format)	Double	Read only	A9EA (43498)	4
Grp3 Read text	Read text string from instrument display	String_60	Read only	A9EE (43502)	30
Reserved				AA0C (43532)	30
Grp3 Write text	Write a text string to instrument display	String_120	Write only	AA2A (43562)	60
Reserved				AA48 (43592)	30
Grp3 Batch start	Boolean Flag. Value 0001 starts new batch	Boolean	Write only	AA66 (43622)	1
Grp3 Batch stop	Boolean Flag. Value 0001 stops current batch	Boolean	Write only	AA67 (43623)	1
Grp3 Batch running	Batch status flag: 1 = Running; 0 = Not running	Boolean	Read only	AA68 (43624)	1
Grp3 Text field 1	Batch field 1 text string (max. 60 characters)	String_60	Read/Write	AA69 (43625)	30
Reserved				AA87 (43655)	30
Grp3 Text field 2	Batch field 2 text string (max. 60 characters)	String_60	Read/Write	AAA5 (43685)	30
Reserved				AAC3 (43715)	30
Grp3 Text field 3	Batch field 3 text string (max. 60 characters)	String_60	Read/Write	AAE1 (43745)	30
Reserved				AAFF (43775)	30
Grp3 Text field 4	Batch field 4 text string (max. 60 characters)	String_60	Read/Write	AB1D (43805)	30
Reserved				AB3B (43835)	30
Grp3 Text field 5	Batch field 5 text string (max. 60 characters)	String_60	Read/Write	AB59 (43865)	30
Reserved				AB77 (43895)	30
Grp3 Text field 6	Batch field 6 text string (max. 60 characters)	String_60	Read/Write	AB95 (43925)	30
Reserved				ABB3 (43955)	30
Spare				ABD1 (43985)	100

8.4.4 GROUP DATA (Cont.)

GROUP 4

Parameter Name	Description	Type	Access	Start Addr. Hex (Dec)	Register Length
Grp4 Trend type	Trend enhancements Enum 0 = Interpolation enabled 1 = Adaptive recording enabled	Read only	AC35 (44085)		1
Grp4 Trend rate	Trend update rate in milliseconds	Uint32	Read only	AC36 (44086)	2
Grp4 Archive rate	Archive (to flash) rate in milliseconds	Uint 32	Read only	AC38 (44088)	2
Grp4 Descriptor	Group descriptor (20 characters max.)	String_20	Read only	AC3A (44090)	10
Spare				AC44 (44100)	10
Grp4 Channels in group	16 Registers holding the group contents, as follows: Register 1 Bit 0: 0 = Point 1 not in group; 1 = Point 1 is in group Bit 1: 0 = Point 2 not in group; 1 = Point 2 is in group Bit 2: 0 = Point 3 not in group; 1 = Point 3 is in group Etc. Bit 15: 0 = Point 16 not in group; 1 = Point 16 is in group	Uint16	Read only	AC4E (44110)	(16) 1
See table 8.3 for point types	Register 2 - as register 1, but for points 17 to 32	Uint16	Read only	AC4F (44111)	1
	Register 3 - as register 1, but for points 33 to 48	Uint16	Read only	AC50 (44112)	1
	Register 4 - as register 1, but for points 49 to 64	Uint16	Read only	AC51 (44113)	1
	Register 5 - as register 1, but for points 65 to 80	Uint16	Read only	AC52 (44114)	1
	Register 6 - as register 1, but for points 81 to 96	Uint16	Read only	AC53 (44115)	1
	Register 7 - as register 1, but for points 97 to 112	Uint16	Read only	AC54 (44116)	1
	Register 8 - as register 1, but for points 113 to 128	Uint16	Read only	AC55 (44117)	1
	Register 9 - as register 1, but for points 129 to 144	Uint16	Read only	AC56 (44118)	1
	Register 10 - as register 1, but for points 145 to 160	Uint16	Read only	AC57 (44119)	1
	Register 11 - as register 1, but for points 161 to 176	Uint16	Read only	AC58 (44120)	1
	Register 12 - as register 1, but for points 177 to 192	Uint16	Read only	AC59 (44121)	1
	Register 13 - as register 1, but for points 193 to 208	Uint16	Read only	AC5A (44122)	1
	Register 14 - as register 1, but for points 209 to 224	Uint16	Read only	AC5B (44123)	1
	Register 15 - as register 1, but for points 225 to 240	Uint16	Read only	AC5C (44124)	1
	Register 16 - as register 1, but for points 241 to 256	Uint16	Read only	AC5D (44125)	1
	Grp4 Text length	Identifies the length of a text message to be read	Uint16	Read/Write	AC5E (44126)
Grp4 Text time stamp	Time stamp of the text message to be read (UTC format)	Double	Read only	AC5F (44127)	4
Grp4 Read text	Read text string from instrument display	String_60	Read only	AC63 (44131)	30
Reserved				AC81 (44161)	30
Grp4 Write text	Write a text string to instrument display	String_60	Write only	AC9F (44191)	30
Reserved				ACBD (44221)	30
Grp4 Batch start	Boolean Flag. Value 0001 starts new batch	Boolean	Write only	ACDB (44251)	1
Grp4 Batch stop	Boolean Flag. Value 0001 stops current batch	Boolean	Write only	ACDC (44252)	1
Grp4 Batch running	Batch status flag: 1 = Running; 0 = Not running	Boolean	Read only	ACDD (44253)	1
Grp4 Text field 1	Batch field 1 text string (max. 60 characters)	String_60	Read/Write	ACDE (44254)	30
Reserved				ACFC (44284)	30
Grp4 Text field 2	Batch field 2 text string (max. 60 characters)	String_60	Read/Write	AD1A (44314)	30
Reserved				AD38 (44344)	30
Grp4 Text field 3	Batch field 3 text string (max. 60 characters)	String_60	Read/Write	AD56 (44374)	30
Reserved				AD74 (44404)	30
Grp4 Text field 4	Batch field 4 text string (max. 60 characters)	String_60	Read/Write	AD92 (44434)	30
Reserved				ADB0 (44464)	30
Grp4 Text field 5	Batch field 5 text string (max. 60 characters)	String_60	Read/Write	ADCE (44494)	30
Reserved				ADEC (44524)	30
Grp4 Text field 6	Batch field 6 text string (max. 60 characters)	String_60	Read/Write	AE0A (44554)	30
Reserved				AE28 (44584)	30
Spare				AE46 (44614)	100

8.4.4 GROUP DATA (Cont.)

GROUP 5

Parameter Name	Description	Type	Access	Start Addr. Hex (Dec)	Register Length
Grp5 Trend type	Trend enhancements Enum 0 = Interpolation enabled 1 = Adaptive recording enabled	Read only	AEEA (44714)		1
Grp5 Trend rate	Trend update rate in milliseconds	Uint32	Read only	AEAB (44715)	2
Grp5 Archive rate	Archive (to flash) rate in milliseconds	Uint 32	Read only	AEAD (44717)	2
Grp5 Descriptor	Group descriptor (20 characters max.)	String_20	Read only	AEAF (44719)	10
Spare				AEB9 (44729)	10
Grp5 Channels in group	16 Registers holding the group contents, as follows: Register 1 Bit 0: 0 = Point 1 not in group; 1 = Point 1 is in group Bit 1: 0 = Point 2 not in group; 1 = Point 2 is in group Bit 2: 0 = Point 3 not in group; 1 = Point 3 is in group Etc. Bit 15: 0 = Point 16 not in group; 1 = Point 16 is in group	Uint16	Read only	AEC3 (44739)	(16) 1
See table 8.3 for point types	Register 2 - as register 1, but for points 17 to 32	Uint16	Read only	AEC4 (44740)	1
	Register 3 - as register 1, but for points 33 to 48	Uint16	Read only	AEC5 (44741)	1
	Register 4 - as register 1, but for points 49 to 64	Uint16	Read only	AEC6 (44742)	1
	Register 5 - as register 1, but for points 65 to 80	Uint16	Read only	AEC7 (44743)	1
	Register 6 - as register 1, but for points 81 to 96	Uint16	Read only	AEC8 (44744)	1
	Register 7 - as register 1, but for points 97 to 112	Uint16	Read only	AEC9 (44745)	1
	Register 8 - as register 1, but for points 113 to 128	Uint16	Read only	AECA (44746)	1
	Register 9 - as register 1, but for points 129 to 144	Uint16	Read only	AECB (44747)	1
	Register 10 - as register 1, but for points 145 to 160	Uint16	Read only	AECC (44748)	1
	Register 11 - as register 1, but for points 161 to 176	Uint16	Read only	AECD (44749)	1
	Register 12 - as register 1, but for points 177 to 192	Uint16	Read only	AECE (44750)	1
	Register 13 - as register 1, but for points 193 to 208	Uint16	Read only	AECF (44751)	1
	Register 14 - as register 1, but for points 209 to 224	Uint16	Read only	AED0 (44752)	1
	Register 15 - as register 1, but for points 225 to 240	Uint16	Read only	AED1 (44753)	1
	Register 16 - as register 1, but for points 241 to 256	Uint16	Read only	AED2 (44754)	1
	Grp5 Text length	Identifies the length of a text message to be read	Uint16	Read/Write	AED3 (44755)
Grp5 Text time stamp	Time stamp of the text message to be read (UTC format)	Double	Read only	AED4 (44756)	4
Grp5 Read text	Read text string from instrument display	String_60	Read only	AED8 (44760)	30
Reserved				AEF6 (44790)	30
Grp5 Write text	Write a text string to instrument display	String_60	Write only	AF14 (44820)	30
Reserved				AF32 (44850)	30
Grp5 Batch start	Boolean Flag. Value 0001 starts new batch	Boolean	Write only	AF50 (44880)	1
Grp5 Batch stop	Boolean Flag. Value 0001 stops current batch	Boolean	Write only	AF51 (44881)	1
Grp5 Batch running	Batch status flag: 1 = Running; 0 = Not running	Boolean	Read only	AF52 (44882)	1
Grp5 Text field 1	Batch field 1 text string (max. 60 characters)	String_60	Read/Write	AF53 (44883)	30
Reserved				AF71 (44913)	30
Grp5 Text field 2	Batch field 2 text string (max. 60 characters)	String_60	Read/Write	AF8F (44943)	30
Reserved				AFAD (44973)	30
Grp5 Text field 3	Batch field 3 text string (max. 60 characters)	String_60	Read/Write	AFCB (45003)	30
Reserved				AFE9 (45033)	30
Grp5 Text field 4	Batch field 4 text string (max. 60 characters)	String_60	Read/Write	B007 (45063)	30
Reserved				B025 (45093)	30
Grp5 Text field 5	Batch field 5 text string (max. 60 characters)	String_60	Read/Write	B043 (45123)	30
Reserved				B061 (45153)	30
Grp5 Text field 6	Batch field 6 text string (max. 60 characters)	String_60	Read/Write	B08F (45183)	30
Reserved				B09D (45213)	30
Spare				B0BB (45243)	100

8.4.4 GROUP DATA (Cont.)

GROUP 6

Parameter Name	Description	Type	Access	Start Addr. Hex (Dec)	Register Length
Grp6 Trend type	Trend enhancements Enum 0 = Interpolation enabled 1 = Adaptive recording enabled	Read only	B11F (45343)	1	
Grp6 Trend rate	Trend update rate in milliseconds	Uint32	Read only	B120 (45344)	2
Grp6 Archive rate	Archive (to flash) rate in milliseconds	Uint 32	Read only	B122 (45346)	2
Grp6 Descriptor	Group descriptor (20 characters max.)	String_20	Read only	B124 (45348)	10
Spare				B12E (45358)	10
Grp6 Channels in group	16 Registers holding the group contents, as follows: Register 1 Bit 0: 0 = Point 1 not in group; 1 = Point 1 is in group Bit 1: 0 = Point 2 not in group; 1 = Point 2 is in group Bit 2: 0 = Point 3 not in group; 1 = Point 3 is in group Etc. Bit 15: 0 = Point 16 not in group; 1 = Point 16 is in group Register 2 - as register 1, but for points 17 to 32 Register 3 - as register 1, but for points 33 to 48 Register 4 - as register 1, but for points 49 to 64 Register 5 - as register 1, but for points 65 to 80 Register 6 - as register 1, but for points 81 to 96 Register 7 - as register 1, but for points 97 to 112 Register 8 - as register 1, but for points 113 to 128 Register 9 - as register 1, but for points 129 to 144 Register 10 - as register 1, but for points 145 to 160 Register 11 - as register 1, but for points 161 to 176 Register 12 - as register 1, but for points 177 to 192 Register 13 - as register 1, but for points 193 to 208 Register 14 - as register 1, but for points 209 to 224 Register 15 - as register 1, but for points 225 to 240 Register 16 - as register 1, but for points 241 to 256	Uint16	Read only	B138 (45368)	1 (16)
		Uint16	Read only	B139 (45369)	1
		Uint16	Read only	B13A (45370)	1
		Uint16	Read only	B13B (45371)	1
		Uint16	Read only	B13C (45372)	1
		Uint16	Read only	B13D (45373)	1
		Uint16	Read only	B13E (45374)	1
		Uint16	Read only	B13F (45375)	1
		Uint16	Read only	B140 (45376)	1
		Uint16	Read only	B141 (45377)	1
		Uint16	Read only	B142 (45378)	1
		Uint16	Read only	B143 (45379)	1
		Uint16	Read only	B144 (45380)	1
		Uint16	Read only	B145 (45381)	1
		Uint16	Read only	B146 (45382)	1
		Uint16	Read only	B147 (45383)	1
Grp6 Text length	Identifies the length of a text message to be read	Uint16	Read/Write	B148 (45384)	1
Grp6 Text time stamp	Time stamp of the text message to be read (UTC format)	Double	Read only	B149 (45385)	4
Grp6 Read text	Read text string from instrument display	String_60	Read only	B14D (45389)	30
Reserved				B16B (45419)	30
Grp6 Write text	Write a text string to instrument display	String_60	Write only	B189 (45449)	30
Reserved				B1A7 (45479)	30
Grp6 Batch start	Boolean Flag. Value 0001 starts new batch	Boolean	Write only	B1C5 (45509)	1
Grp6 Batch stop	Boolean Flag. Value 0001 stops current batch	Boolean	Write only	B1C6 (45510)	1
Grp6 Batch running	Batch status flag: 1 = Running; 0 = Not running	Boolean	Read only	B1C7 (45511)	1
Grp6 Text field 1	Batch field 1 text string (max. 60 characters)	String_60	Read/Write	B1C8 (45512)	30
Reserved				B1E6 (45542)	30
Grp6 Text field 2	Batch field 2 text string (max. 60 characters)	String_60	Read/Write	B204 (45572)	30
Reserved				B222 (45602)	30
Grp6 Text field 3	Batch field 3 text string (max. 60 characters)	String_60	Read/Write	B240 (45632)	30
Reserved				B25E (45662)	30
Grp6 Text field 4	Batch field 4 text string (max. 60 characters)	String_60	Read/Write	B27C (45692)	30
Reserved				B29A (45722)	30
Grp6 Text field 5	Batch field 5 text string (max. 60 characters)	String_60	Read/Write	B2B8 (45752)	30
Reserved				B2D6 (45782)	30
Grp6 Text field 6	Batch field 6 text string (max. 60 characters)	String_60	Read/Write	B2F4 (45812)	30
Reserved				B312 (45842)	30
Spare				B330 (45872)	100

See [table 8.3](#)
for point types

8.4.5 Feature identification table (FIT)

This table allows the host to identify which features are available at the recorder.

Parameter Name	Description	Value	Access	Start Addr. Hex (Dec)	Register Length
Number of features	Number of supported features	3	Read only	CC26 (52262)	1
	Feature 1	Indirection Table	Read only	CC27 (52263)	1
	Read only indirection table start address (R/O vector)	CD89	Read only	CC28 (52264)	1
	Read/Write indirection table start address (R/W vector)	D18A	Read only	CC29 (52265)	1
Feature 2	Spare			CC2A (52266)	1
	Function codes supported (FC I.D.)	4	Read only	CC2B (52267)	1
	Bit map of supported MODBUS function codes	32940	Read only	CC2C (52268)	1
	Bit 0: 0 = code 1 not supported; 1 = code 1 supported				
	Bit 1: 0 = code 2 not supported; 1 = code 2 supported				
	Bit 2: 0 = code 3 not supported; 1 = code 3 supported				
Bit 3: 0 = code 4 not supported; 1 = code 4 supported					
Etc.					
Bit 15: 0 = code 16 not supported; 1 = code 16 supported					
Feature 3	Reserved			CC2D (52269)	1
	Reserved			CC2E (52270)	1
	Security ID (MODBUS login security feature)	9	Read only	CC2F (52271)	1
	User name		Write only	CC30 (52272)	40
	Password		Write only	CC58 (52312)	40
Feature N	Reserved			CC80 (52352)	1
	100 Spare addresses for further features			CC81 (52353)	100

8.4.6 Indirection tables

The standard MODBUS protocol allows block register reads and writes. This is efficient only if data is grouped contiguously, or nearly so. Indirection tables are a means by which widely spaced register addresses can (in effect) be grouped, offering the host the ability to access a block of user defined data in one single read/write request.

Two configurable tables are available, one for read only parameters, the other for read/write. Each table is in two halves - the lower address half contains the addresses of the registers to be accessed; the higher address half contains the values which have been read or which are to be written.

Notes:

1. For Ethernet connections, indirection table entries are lost at power off, as the result of a brown-out or if the connection with the host is broken.
2. Parameters in IEEE format can be accessed by configuring two successive entries in the table. Parameters which occupy more than one register can be loaded into the indirection area by using function code 16 (pre-set multiple registers) and the parameter's base address (i.e. the parameter's 1st register).
3. Separate indirection table entries are held for each host - the recorder automatically switches each host to its own indirection table without user intervention.
4. Indirection table addresses (CCE5 to D4E7) cannot be entered in the indirection tables. Any attempt to do so will be ignored.

8.4.6 INDIRECTION TABLES (CONT.)

Table 8.4.6a shows the overall arrangement of the indirection table area. Figures 8.4.6b and 8.4.6c show simple examples of Read only and Read/Write addressing for tables with 6 entries.

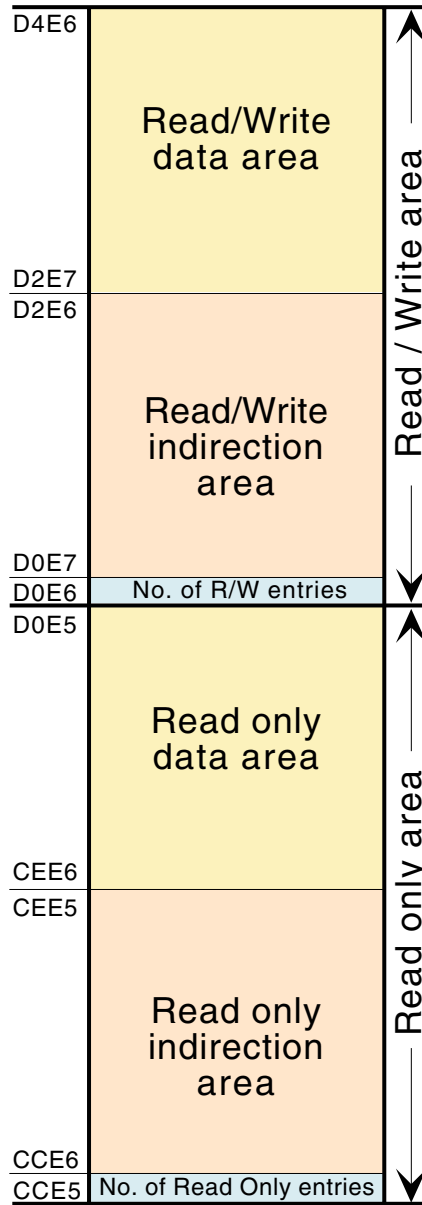

Table 8.4.6a Indirection table areas

8.4.6 INDIRECTION TABLES (CONT.)

Read values from here (address + hex 200)	CCEB	Alarms chan 1	
	CCEA	PV chan 1	
	CCE9	PV chan 1	
	CCE8	Archive rate	
	CCE7	Trend rate	
	CCE6	Instrument type	

Enter required data addresses here	CCEB	A1DB	Channel 1 Alarm status
	CCEA	F8C4	Channel 1 PV (bits 16 to 31)
	CCE9	F8C3	Channel 1 PV (bits 0 to 15)
	CCE8	A4D9	Group 1 archive rate
	CCE7	A4D7	Group 1 trend rate
	CCE6	0001	Instrument type number
	CCE5	0006	Number of Read only entries

Table 8.4.6b Read only indirection example

Write values to, or read values from this area (address + hex 200)	D2EC	Ch6 Alarm1 Sp	
	D2EB	Ch5 Alarm1 Sp	
	D2EA	Ch4 Alarm1 Sp	
	D2E9	Ch3 Alarm1 Sp	
	D2E8	Ch2 Alarm1 Sp	
	D2E7	Ch1 Alarm1 Sp	

Enter required data addresses here	D0EC	0415	Chan 6 Alarm 1 setpoint
	D0EB	0373	Chan 5 Alarm 1 setpoint
	D0EA	02D1	Chan 4 Alarm 1 setpoint
	D0E9	022F	Chan 3 Alarm 1 setpoint
	D0E8	018D	Chan 2 Alarm 1 setpoint
	D0E7	00EB	Chan 1 Alarm 1 setpoint
	D0E6	0006	Number of Read/Write entries

Table 8.4.6c Read/Write indirection example

8.4.7 IEEE 32-bit channel configuration data

The following tables show the hexadecimal addresses for the specified 32-bit floating-point values, for channels 1 to 12. Generally, Parameter address for channel N = Parameter address for channel 1 + 36(N-1) (decimal). The word channel is used as an umbrella term for input channels, maths channels, totalisers etc.

Note: A/B Switching:
B values are not accessible via modbus for this software version. Span, Zone, Colour etc. are therefore all setting A

CHANNEL 1

Parameter Name	Description	Type	Access	Start Addr. Hex (Dec)	Register Length
Ch1 span high	Upper span value (Display full scale)	Float	Read only	D4E7 (54503)	2
Ch1 span low	Lower span value (display 'zero')	Float	Read only	D4E9 (54505)	2
Ch1 Zone high	Zone upper value (% of 'chart' width)	Float	Read only	D4EB (54507)	2
Ch1 Zone low	Zone lower value (% of 'chart' width)	Float	Read only	D4ED (54509)	2
Ch1 Alarm 1 setpoint	Trigger setpoint (Note 2) for alarm 1 (Note 2)	Float	Read/Write	D4EF (54511)	2
Ch1 Alarm 2 setpoint	Trigger setpoint (Note 2) for alarm 2 (Note 2)	Float	Read/Write	D4F1 (54513)	2
Ch1 Alarm 3 setpoint	Trigger setpoint (Note 2) for alarm 3 (Note 2)	Float	Read/Write	D4F3 (54515)	2
Ch1 Alarm 4 setpoint	Trigger setpoint (Note 2) for alarm 4 (Note 2)	Float	Read/Write	D4F5 (54517)	2
Spare				D4F7 (54519)	20

CHANNEL 2

Parameter Name	Description	Type	Access	Start Addr. Hex (Dec)	Register Length
Ch2 span high	Upper span value (display full scale)	Float	Read only	D50B (54539)	2
Ch2 span low	Lower span value (display 'zero')	Float	Read only	D50D (54541)	2
Ch2 Zone high	Zone upper value (% of 'chart' width)	Float	Read only	D50F (54543)	2
Ch2 Zone low	Zone lower value (% of 'chart' width)	Float	Read only	D511 (54545)	2
Ch2 Alarm 1 setpoint	Trigger setpoint for alarm 1 (Note 2)	Float	Read/Write	D513 (54547)	2
Ch2 Alarm 2 setpoint	Trigger setpoint for alarm 2 (Note 2)	Float	Read/Write	D515 (54549)	2
Ch2 Alarm 3 setpoint	Trigger setpoint for alarm 3 (Note 2)	Float	Read/Write	D517 (54551)	2
Ch2 Alarm 4 setpoint	Trigger setpoint for alarm 4 (Note 2)	Float	Read/Write	D519 (54553)	2
Spare				D51B (54555)	20

CHANNEL 3

Parameter Name	Description	Type	Access	Start Addr. Hex (Dec)	Register Length
Ch3 span high	Upper span value (display full scale)	Float	Read only	D52F (54575)	2
Ch3 span low	Lower span value (display 'zero')	Float	Read only	D531 (54577)	2
Ch3 Zone high	Zone upper value (% of 'chart' width)	Float	Read only	D533 (54579)	2
Ch3 Zone low	Zone lower value (% of 'chart' width)	Float	Read only	D535 (54581)	2
Ch3 Alarm 1 setpoint	Trigger setpoint for alarm 1 (Note 2)	Float	Read/Write	D537 (54583)	2
Ch3 Alarm 2 setpoint	Trigger setpoint for alarm 2 (Note 2)	Float	Read/Write	D539 (54585)	2
Ch3 Alarm 3 setpoint	Trigger setpoint for alarm 3 (Note 2)	Float	Read/Write	D53B (54587)	2
Ch3 Alarm 4 setpoint	Trigger setpoint for alarm 4 (Note 2)	Float	Read/Write	D53D (54589)	2
Spare				D53F (54591)	20

Notes

1. For maths, totalisers and counters, see the relevant option description.
2. If an alarm's Setpoint Source (section 4.3.3) is set to anything other than 'Constant' the value returned will be the previously configured constant value.

8.4.7 IEEE 32-BIT CHANNEL CONFIGURATION DATA (Cont.)**CHANNEL 4**

Parameter Name	Description	Type	Access	Start Addr. Hex (Dec)	Register Length
Ch4 span high	Upper span value (display full scale)	Float	Read only	D553 (54611)	2
Ch4 span low	Lower span value (display 'zero')	Float	Read only	D555 (54613)	2
Ch4 Zone high	Zone upper value (% of 'chart' width)	Float	Read only	D557 (54615)	2
Ch4 Zone low	Zone lower value (% of 'chart' width)	Float	Read only	D559 (54617)	2
Ch4 Alarm 1 setpoint	Trigger setpoint for alarm 1 (Note 2)	Float	Read/Write	D55B (54619)	2
Ch4 Alarm 2 setpoint	Trigger setpoint for alarm 2 (Note 2)	Float	Read/Write	D55D (54621)	2
Ch4 Alarm 3 setpoint	Trigger setpoint for alarm 3 (Note 2)	Float	Read/Write	D55F (54623)	2
Ch4 Alarm 4 setpoint	Trigger setpoint for alarm 4 (Note 2)	Float	Read/Write	D561 (54625)	2
Spare				D563 (54627)	20

CHANNEL 5

Parameter Name	Description	Type	Access	Start Addr. Hex (Dec)	Register Length
Ch5 span high	Upper span value (display full scale)	Float	Read only	D577 (54647)	2
Ch5 span low	Lower span value (display 'zero')	Float	Read only	D569 (54649)	2
Ch5 Zone high	Zone upper value (% of 'chart' width)	Float	Read only	D57B (54651)	2
Ch5 Zone low	Zone lower value (% of 'chart' width)	Float	Read only	D57D (54653)	2
Ch5 Alarm 1 setpoint	Trigger setpoint for alarm 1 (Note 2)	Float	Read/Write	D57F (54655)	2
Ch5 Alarm 2 setpoint	Trigger setpoint for alarm 2 (Note 2)	Float	Read/Write	D581 (54657)	2
Ch5 Alarm 3 setpoint	Trigger setpoint for alarm 3 (Note 2)	Float	Read/Write	D583 (54659)	2
Ch5 Alarm 4 setpoint	Trigger setpoint for alarm 4 (Note 2)	Float	Read/Write	D585 (54661)	2
Spare				D587 (54663)	20

CHANNEL 6

Parameter Name	Description	Type	Access	Start Addr. Hex (Dec)	Register Length
Ch6 span high	Upper span value (display full scale)	Float	Read only	D59B (54683)	2
Ch6 span low	Lower span value (display 'zero')	Float	Read only	D59D (54685)	2
Ch6 Zone high	Zone upper value (% of 'chart' width)	Float	Read only	D59F (54687)	2
Ch6 Zone low	Zone lower value (% of 'chart' width)	Float	Read only	D5A1 (54689)	2
Ch6 Alarm 1 setpoint	Trigger setpoint for alarm 1 (Note 2)	Float	Read/Write	D5A3 (54691)	2
Ch6 Alarm 2 setpoint	Trigger setpoint for alarm 2 (Note 2)	Float	Read/Write	D5A5 (54693)	2
Ch6 Alarm 3 setpoint	Trigger setpoint for alarm 3 (Note 2)	Float	Read/Write	D5A7 (54695)	2
Ch6 Alarm 4 setpoint	Trigger setpoint for alarm 4 (Note 2)	Float	Read/Write	D5A9 (54697)	2
Spare				D5AB (54699)	20

Notes

1. For maths, totalisers and counters, see the relevant option description.
2. If an alarm's Setpoint Source (section 4.3.3) is set to anything other than 'Constant' the value returned will be the previously configured constant value.

8.4.7 IEEE 32-BIT CHANNEL CONFIGURATION DATA (Cont.)**CHANNEL 7**

Parameter Name	Description	Type	Access	Start Addr. Hex (Dec)	Register Length
Ch7 span high	Upper span value (display full scale)	Float	Read only	D5BF (54719)	2
Ch7 span low	Lower span value (display 'zero')	Float	Read only	D5C1 (54721)	2
Ch7 Zone high	Zone upper value (% of 'chart' width)	Float	Read only	D5C3 (54723)	2
Ch7 Zone low	Zone lower value (% of 'chart' width)	Float	Read only	D5C5 (54725)	2
Ch7 Alarm 1 setpoint	Trigger setpoint for alarm 1 (Note 2)	Float	Read/Write	D5C7 (54727)	2
Ch7 Alarm 2 setpoint	Trigger setpoint for alarm 2 (Note 2)	Float	Read/Write	D5C9 (54729)	2
Ch7 Alarm 3 setpoint	Trigger setpoint for alarm 3 (Note 2)	Float	Read/Write	D5CB (54731)	2
Ch7 Alarm 4 setpoint	Trigger setpoint for alarm 4 (Note 2)	Float	Read/Write	D5CD (54733)	2
Spare				D5CF (54735)	20

CHANNEL 8

Parameter Name	Description	Type	Access	Start Addr. Hex (Dec)	Register Length
Ch8 span high	Upper span value (display full scale)	Float	Read only	D5E3 (54755)	2
Ch8 span low	Lower span value (display 'zero')	Float	Read only	D5E5 (54757)	2
Ch8 Zone high	Zone upper value (% of 'chart' width)	Float	Read only	D5E7 (54759)	2
Ch8 Zone low	Zone lower value (% of 'chart' width)	Float	Read only	D5E9 (54761)	2
Ch8 Alarm 1 setpoint	Trigger setpoint for alarm 1 (Note 2)	Float	Read/Write	D5EB (54763)	2
Ch8 Alarm 2 setpoint	Trigger setpoint for alarm 2 (Note 2)	Float	Read/Write	D5ED (54765)	2
Ch8 Alarm 3 setpoint	Trigger setpoint for alarm 3 (Note 2)	Float	Read/Write	D5EF (54767)	2
Ch8 Alarm 4 setpoint	Trigger setpoint for alarm 4 (Note 2)	Float	Read/Write	D5F1 (54769)	2
Spare				D5F3 (54771)	20

CHANNEL 9

Parameter Name	Description	Type	Access	Start Addr. Hex (Dec)	Register Length
Ch9 span high	Upper span value (display full scale)	Float	Read only	D607 (54791)	2
Ch9 span low	Lower span value (display 'zero')	Float	Read only	D609 (54793)	2
Ch9 Zone high	Zone upper value (% of 'chart' width)	Float	Read only	D60B (54795)	2
Ch9 Zone low	Zone lower value (% of 'chart' width)	Float	Read only	D60D (54797)	2
Ch9 Alarm 1 setpoint	Trigger setpoint for alarm 1 (Note 2)	Float	Read/Write	D60F (54799)	2
Ch9 Alarm 2 setpoint	Trigger setpoint for alarm 2 (Note 2)	Float	Read/Write	D611 (54801)	2
Ch9 Alarm 3 setpoint	Trigger setpoint for alarm 3 (Note 2)	Float	Read/Write	D613 (54803)	2
Ch9 Alarm 4 setpoint	Trigger setpoint for alarm 4 (Note 2)	Float	Read/Write	D615 (54805)	2
Spare				D617 (54807)	20

Notes

1. For maths, totalisers and counters, see the relevant option description.
2. If an alarm's Setpoint Source (section 4.3.3) is set to anything other than 'Constant' the value returned will be the previously configured constant value.

8.4.7 IEEE 32-BIT CHANNEL CONFIGURATION DATA (Cont.)**CHANNEL 10**

Parameter Name	Description	Type	Access	Start Addr. Hex (Dec)	Register Length
Ch10 span high	Upper span value (display full scale)	Float	Read only	D62B (54827)	2
Ch10 span low	Lower span value (display 'zero')	Float	Read only	D62D (54829)	2
Ch10 Zone high	Zone upper value (% of 'chart' width)	Float	Read only	D62F (54831)	2
Ch10 Zone low	Zone lower value (% of 'chart' width)	Float	Read only	D631 (54833)	2
Ch10 Alarm 1 setpoint	Trigger setpoint for alarm 1 (Note 2)	Float	Read/Write	D633 (54835)	2
Ch10 Alarm 2 setpoint	Trigger setpoint for alarm 2 (Note 2)	Float	Read/Write	D635 (54837)	2
Ch10 Alarm 3 setpoint	Trigger setpoint for alarm 3 (Note 2)	Float	Read/Write	D637 (54839)	2
Ch10 Alarm 4 setpoint	Trigger setpoint for alarm 4 (Note 2)	Float	Read/Write	D639 (54841)	2
Spare				D63B (54843)	20

CHANNEL 11

Parameter Name	Description	Type	Access	Start Addr. Hex (Dec)	Register Length
Ch11 span high	Upper span value (display full scale)	Float	Read only	D64F (54863)	2
Ch11 span low	Lower span value (display 'zero')	Float	Read only	D651 (54865)	2
Ch11 Zone high	Zone upper value (% of 'chart' width)	Float	Read only	D653 (54867)	2
Ch11 Zone low	Zone lower value (% of 'chart' width)	Float	Read only	D655 (54869)	2
Ch11 Alarm 1 setpoint	Trigger setpoint for alarm 1 (Note 2)	Float	Read/Write	D657 (54871)	2
Ch11 Alarm 2 setpoint	Trigger setpoint for alarm 2 (Note 2)	Float	Read/Write	D659 (54873)	2
Ch11 Alarm 3 setpoint	Trigger setpoint for alarm 3 (Note 2)	Float	Read/Write	D65B (54875)	2
Ch11 Alarm 4 setpoint	Trigger setpoint for alarm 4 (Note 2)	Float	Read/Write	D65D (54877)	2
Spare				D65F (54879)	20

CHANNEL 12

Parameter Name	Description	Type	Access	Start Addr. Hex (Dec)	Register Length
Ch12 span high	Upper span value (display full scale)	Float	Read only	D673 (54899)	2
Ch12 span low	Lower span value (display 'zero')	Float	Read only	D675 (54901)	2
Ch12 Zone high	Zone upper value (% of 'chart' width)	Float	Read only	D677 (54903)	2
Ch12 Zone low	Zone lower value (% of 'chart' width)	Float	Read only	D679 (54905)	2
Ch12 Alarm 1 setpoint	Trigger setpoint for alarm 1 (Note 2)	Float	Read/Write	D67B (54907)	2
Ch12 Alarm 2 setpoint	Trigger setpoint for alarm 2 (Note 2)	Float	Read/Write	D67D (54909)	2
Ch12 Alarm 3 setpoint	Trigger setpoint for alarm 3 (Note 2)	Float	Read/Write	D67F (54911)	2
Ch12 Alarm 4 setpoint	Trigger setpoint for alarm 4 (Note 2)	Float	Read/Write	D681 (54913)	2
Spare				D683 (54915)	20

Notes

1. For maths, totalisers and counters, see the relevant option description.
2. If an alarm's Setpoint Source (section 4.3.3) is set to anything other than 'Constant' the value returned will be the previously configured constant value.

8.4.8 IEEE Area Channel run-time data

The following tables show the hexadecimal addresses for the specified 32-bit floating-point values, for channels 1 to 12. Generally, Parameter address for channel N = Parameter address for channel 1 + 4(N-1) (decimal).

CHANNEL 1

Parameter Name	Description	Type	Access	Start Addr. Hex (Dec)	Register Length
Channel 1 value	Current process value (PV)	Float	See note	F8C3 (63683)	2
Channel 1 status	Channel status 0 = Good PV 5 = Ranging error 1 = Channel off 6 = Overflow 2 = Over range 7 = Bad PV 3 = Under range 8 = No data 4 = Hardware error	Enum	Read only	F8C5 (63685)	1
Channel 1 Alarms	Alarm information Bit 0: 0 = Alarm 1 inactive; 1 = Alarm 1 active Bit 1: 0 = No alarm 1 Ack. required; 1 = Ack. required Bit 2: 1 = Acknowledge alarm 1 Bit 3: Spare Bit 4: 0 = Alarm 2 inactive; 1 = Alarm 2 active Bit 5: 0 = No Alarm 2 Ack. required; 1 = Ack. required Bit 6: 1 = Acknowledge alarm 2 Bit 7: Spare Bit 8: 0 = Alarm 3 inactive; 1 = Alarm 3 active Bit 9: 0 = No alarm 3 Ack. required; 1 = Ack. required Bit 10: 1 = Acknowledge alarm 3 Bit 11: Spare Bit 12: 0 = Alarm 4 inactive; 1 = Alarm 4 active Bit 13: 0 = No Alarm 4 Ack. required; 1 = Ack. required Bit 14: 1 = Acknowledge alarm 4 Bit 15: Spare	Uint16	- Read only Read only Read/Write Read only Read only Read/Write Read only Read only Read/Write Read only Read only Read/Write	F8C6 (63686)	1

CHANNEL 2

Parameter Name	Description	Type	Access	Start Addr. Hex (Dec)	Register Length
Channel 2 value	Current process value (PV)	Float	See note	F8C7 (63687)	2
Channel 2 status	Channel status 0 = Good PV 5 = Ranging error 1 = Channel off 6 = Overflow 2 = Over range 7 = Bad PV 3 = Under range 8 = No data 4 = Hardware error	Enum	Read only	F8C9 (63689)	1
Channel 2 alarms	Alarm information Bit 0: 0 = Alarm 1 inactive; 1 = Alarm 1 active Bit 1: 0 = No alarm 1 Ack. required; 1 = Ack. required Bit 2: 1 = Acknowledge alarm 1 Bit 3: Spare Bit 4: 0 = Alarm 2 inactive; 1 = Alarm 2 active Bit 5: 0 = No Alarm 2 Ack. required; 1 = Ack. required Bit 6: 1 = Acknowledge alarm 2 Bit 7: Spare Bit 8: 0 = Alarm 3 inactive; 1 = Alarm 3 active Bit 9: 0 = No alarm 3 Ack. required; 1 = Ack. required Bit 10: 1 = Acknowledge alarm 3 Bit 11: Spare Bit 12: 0 = Alarm 4 inactive; 1 = Alarm 4 active Bit 13: 0 = No Alarm 4 Ack. required; 1 = Ack. required Bit 14: 1 = Acknowledge alarm 4 Bit 15: Spare	Uint16	- Read only Read only Read/Write Read only Read only Read/Write Read only Read only Read/Write	F8CA (63690)	1

Note: PV access is Read/Write for any point configured with 'Slave Comms' as its Type or Function. Otherwise PV access is Read only.

8.4.8 IEEE AREA CHANNEL RUN-TIME DATA (Cont.)

CHANNEL 3

Parameter Name	Description	Type	Access	Start Addr. Hex (Dec)	Register Length
Channel 3 value	Current process value (PV)	Float	See note	F8CB (63691)	2
Channel 3 status	Channel status 0 = Good PV 5 = Ranging error 1 = Channel off 6 = Overflow 2 = Over range 7 = Bad PV 3 = Under range 8 = No data 4 = Hardware error	Enum	Read only	F8CD (63693)	1
Channel 3 Alarms	Alarm information Bit 0:0 = Alarm 1 inactive; 1 = Alarm 1 active Bit 1:0 = No alarm 1 Ack. required; 1 = Ack. required Bit 2:1 = Acknowledge alarm 1 Bit 3:Spare Bit 4:0 = Alarm 2 inactive; 1 = Alarm 2 active Bit 5:0 = No Alarm 2 Ack. required; 1 = Ack. required Bit 6:1 = Acknowledge alarm 2 Bit 7:Spare Bit 8:0 = Alarm 3 inactive; 1 = Alarm 3 active Bit 9:0 = No alarm 3 Ack. required; 1 = Ack. required Bit 10:1 = Acknowledge alarm 3 Bit 11:Spare Bit 12:0 = Alarm 4 inactive; 1 = Alarm 4 active Bit 13:0 = No Alarm 4 Ack. required; 1 = Ack. required Bit 14:1 = Acknowledge alarm 4 Bit 15:Spare	Uint16	- Read only Read only Read/Write Read only Read only Read/Write Read only Read only Read/Write	F8CE (63694)	1

CHANNEL 4

Parameter Name	Description	Type	Access	Start Addr. Hex (Dec)	Register Length
Channel 4 value	Current process value (PV)	Float	See note	F8CF (63695)	2
Channel 4 status	Channel status 0 = Good PV 5 = Ranging error 1 = Channel off 6 = Overflow 2 = Over range 7 = Bad PV 3 = Under range 8 = No data 4 = Hardware error	Enum	Read only	F8D1 (63697)	1
Channel 4 alarms	Alarm information Bit 0: 0 = Alarm 1 inactive; 1 = Alarm 1 active Bit 1: 0 = No alarm 1 Ack. required; 1 = Ack. required Bit 2: 1 = Acknowledge alarm 1 Bit 3: Spare Bit 4: 0 = Alarm 2 inactive; 1 = Alarm 2 active Bit 5: 0 = No Alarm 2 Ack. required; 1 = Ack. required Bit 6: 1 = Acknowledge alarm 2 Bit 7: Spare Bit 8: 0 = Alarm 3 inactive; 1 = Alarm 3 active Bit 9: 0 = No alarm 3 Ack. required; 1 = Ack. required Bit 10: 1 = Acknowledge alarm 3 Bit 11: Spare Bit 12: 0 = Alarm 4 inactive; 1 = Alarm 4 active Bit 13: 0 = No Alarm 4 Ack. required; 1 = Ack. required Bit 14: 1 = Acknowledge alarm 4 Bit 15: Spare	Uint16	- Read only Read only Read/Write Read only Read only Read/Write Read only Read only Read/Write	F8D2 (63698)	1

Note: PV access is Read/Write for any point configured with 'Slave Comms' as its Type or Function. Otherwise PV access is Read only.

8.4.8 IEEE AREA CHANNEL RUN-TIME DATA (Cont.)

CHANNEL 5

Parameter Name	Description	Type	Access	Start Addr. Hex (Dec)	Register Length
Channel 5 value	Current process value (PV)	Float	See note	F8D3 (63699)	2
Channel 5 status	Channel status 0 = Good PV 5 = Ranging error 1 = Channel off 6 = Overflow 2 = Over range 7 = Bad PV 3 = Under range 8 = No data 4 = Hardware error	Enum	Read only	F8D5 (63701)	1
Channel 5 Alarms	Alarm information Bit 0: 0 = Alarm 1 inactive; 1 = Alarm 1 active Bit 1: 0 = No alarm 1 Ack. required; 1 = Ack. required Bit 2: 1 = Acknowledge alarm 1 Bit 3: Spare Bit 4: 0 = Alarm 2 inactive; 1 = Alarm 2 active Bit 5: 0 = No Alarm 2 Ack. required; 1 = Ack. required Bit 6: 1 = Acknowledge alarm 2 Bit 7: Spare Bit 8: 0 = Alarm 3 inactive; 1 = Alarm 3 active Bit 9: 0 = No alarm 3 Ack. required; 1 = Ack. required Bit 10: 1 = Acknowledge alarm 3 Bit 11: Spare Bit 12: 0 = Alarm 4 inactive; 1 = Alarm 4 active Bit 13: 0 = No Alarm 4 Ack. required; 1 = Ack. required Bit 14: 1 = Acknowledge alarm 4 Bit 15: Spare	Uint16	- Read only Read only Read/Write Read only Read only Read/Write Read only Read only Read/Write Read only Read only Read/Write	F8D6 (63702)	1

CHANNEL 6

Parameter Name	Description	Type	Access	Start Addr. Hex (Dec)	Register Length
Channel 6 value	Current process value (PV)	Float	See note	F8D7 (63703)	2
Channel 6 status	Channel status 0 = Good PV 5 = Ranging error 1 = Channel off 6 = Overflow 2 = Over range 7 = Bad PV 3 = Under range 8 = No data 4 = Hardware error	Enum	Read only	F8D9 (63705)	1
Channel 6 alarms	Alarm information Bit 0: 0 = Alarm 1 inactive; 1 = Alarm 1 active Bit 1: 0 = No alarm 1 Ack. required; 1 = Ack. required Bit 2: 1 = Acknowledge alarm 1 Bit 3: Spare Bit 4: 0 = Alarm 2 inactive; 1 = Alarm 2 active Bit 5: 0 = No Alarm 2 Ack. required; 1 = Ack. required Bit 6: 1 = Acknowledge alarm 2 Bit 7: Spare Bit 8: 0 = Alarm 3 inactive; 1 = Alarm 3 active Bit 9: 0 = No alarm 3 Ack. required; 1 = Ack. required Bit 10: 1 = Acknowledge alarm 3 Bit 11: Spare Bit 12: 0 = Alarm 4 inactive; 1 = Alarm 4 active Bit 13: 0 = No Alarm 4 Ack. required; 1 = Ack. required Bit 14: 1 = Acknowledge alarm 4 Bit 15: Spare	Uint16	- Read only Read only Read/Write Read only Read only Read/Write Read only Read only Read/Write	F8DA (63706)	1

Note: PV access is Read/Write for any point configured with 'Slave Comms' as its Type or Function. Otherwise PV access is Read only.

8.4.8 IEEE AREA CHANNEL RUN-TIME DATA (Cont.)**CHANNEL 7**

Parameter Name	Description	Type	Access	Start Addr. Hex (Dec)	Register Length
Channel 7 value	Current process value (PV)	Float	See note	F8DB (63707)	2
Channel 7 status	Channel status 0 = Good PV 5 = Ranging error 1 = Channel off 6 = Overflow 2 = Over range 7 = Bad PV 3 = Under range 8 = No data 4 = Hardware error	Enum	Read only	F8DD (63709)	1
Channel 7 Alarms	Alarm information Bit 0: 0 = Alarm 1 inactive; 1 = Alarm 1 active Bit 1: 0 = No alarm 1 Ack. required; 1 = Ack. required Bit 2: 1 = Acknowledge alarm 1 Bit 3: Spare Bit 4: 0 = Alarm 2 inactive; 1 = Alarm 2 active Bit 5: 0 = No Alarm 2 Ack. required; 1 = Ack. required Bit 6: 1 = Acknowledge alarm 2 Bit 7: Spare Bit 8: 0 = Alarm 3 inactive; 1 = Alarm 3 active Bit 9: 0 = No alarm 3 Ack. required; 1 = Ack. required Bit 10: 1 = Acknowledge alarm 3 Bit 11: Spare Bit 12: 0 = Alarm 4 inactive; 1 = Alarm 4 active Bit 13: 0 = No Alarm 4 Ack. required; 1 = Ack. required Bit 14: 1 = Acknowledge alarm 4 Bit 15: Spare	Uint16	- Read only Read only Read/Write Read only Read only Read/Write Read only Read only Read/Write Read only Read only Read/Write	F8DE (63710)	1

CHANNEL 8

Parameter Name	Description	Type	Access	Start Addr. Hex (Dec)	Register Length
Channel 8 value	Current process value (PV)	Float	See note	F8DF (63711)	2
Channel 8 status	Channel status 0 = Good PV 5 = Ranging error 1 = Channel off 6 = Overflow 2 = Over range 7 = Bad PV 3 = Under range 8 = No data 4 = Hardware error	Enum	Read only	F8E1 (63713)	1
Channel 8 alarms	Alarm information Bit 0: 0 = Alarm 1 inactive; 1 = Alarm 1 active Bit 1: 0 = No alarm 1 Ack. required; 1 = Ack. required Bit 2: 1 = Acknowledge alarm 1 Bit 3: Spare Bit 4: 0 = Alarm 2 inactive; 1 = Alarm 2 active Bit 5: 0 = No Alarm 2 Ack. required; 1 = Ack. required Bit 6: 1 = Acknowledge alarm 2 Bit 7: Spare Bit 8: 0 = Alarm 3 inactive; 1 = Alarm 3 active Bit 9: 0 = No alarm 3 Ack. required; 1 = Ack. required Bit 10: 1 = Acknowledge alarm 3 Bit 11: Spare Bit 12: 0 = Alarm 4 inactive; 1 = Alarm 4 active Bit 13: 0 = No Alarm 4 Ack. required; 1 = Ack. required Bit 14: 1 = Acknowledge alarm 4 Bit 15: Spare	Uint16	- Read only Read only Read/Write Read only Read only Read/Write Read only Read only Read/Write	F8E2 (63714)	1

Note: PV access is Read/Write for any point configured with 'Slave Comms' as its Type or Function. Otherwise PV access is Read only.

8.4.8 IEEE AREA CHANNEL RUN-TIME DATA (Cont.)

CHANNEL 9

Parameter Name	Description	Type	Access	Start Addr. Hex (Dec)	Register Length
Channel 9 value	Current process value (PV)	Float	See note	F8E3 (63715)	2
Channel 9 status	Channel status 0 = Good PV 5 = Ranging error 1 = Channel off 6 = Overflow 2 = Over range 7 = Bad PV 3 = Under range 8 = No data 4 = Hardware error	Enum	Read only	F8E5 (63717)	1
Channel 9 Alarms	Alarm information Bit 0: 0 = Alarm 1 inactive; 1 = Alarm 1 active Bit 1: 0 = No alarm 1 Ack. required; 1 = Ack. required Bit 2: 1 = Acknowledge alarm 1 Bit 3: Spare Bit 4: 0 = Alarm 2 inactive; 1 = Alarm 2 active Bit 5: 0 = No Alarm 2 Ack. required; 1 = Ack. required Bit 6: 1 = Acknowledge alarm 2 Bit 7: Spare Bit 8: 0 = Alarm 3 inactive; 1 = Alarm 3 active Bit 9: 0 = No alarm 3 Ack. required; 1 = Ack. required Bit 10: 1 = Acknowledge alarm 3 Bit 11: Spare Bit 12: 0 = Alarm 4 inactive; 1 = Alarm 4 active Bit 13: 0 = No Alarm 4 Ack. required; 1 = Ack. required Bit 14: 1 = Acknowledge alarm 4 Bit 15: Spare	Uint16	- Read only Read only Read/Write Read only Read only Read/Write Read only Read only Read/Write Read only Read only Read/Write	F8E6 (63718)	1

CHANNEL 10

Parameter Name	Description	Type	Access	Start Addr. Hex (Dec)	Register Length
Channel 10 value	Current process value (PV)	Float	See note	F8E7 (63719)	2
Channel 10 status	Channel status 0 = Good PV 5 = Ranging error 1 = Channel off 6 = Overflow 2 = Over range 7 = Bad PV 3 = Under range 8 = No data 4 = Hardware error	Enum	Read only	F8E9 (63721)	1
Channel 10 alarms	Alarm information Uint16 Bit 0: 0 = Alarm 1 inactive; 1 = Alarm 1 active Bit 1: 0 = No alarm 1 Ack. required; 1 = Ack. required Bit 2: 1 = Acknowledge alarm 1 Bit 3: Spare Bit 4: 0 = Alarm 2 inactive; 1 = Alarm 2 active Bit 5: 0 = No Alarm 2 Ack. required; 1 = Ack. required Bit 6: 1 = Acknowledge alarm 2 Bit 7: Spare Bit 8: 0 = Alarm 3 inactive; 1 = Alarm 3 active Bit 9: 0 = No alarm 3 Ack. required; 1 = Ack. required Bit 10: 1 = Acknowledge alarm 3 Bit 11: Spare Bit 12: 0 = Alarm 4 inactive; 1 = Alarm 4 active Bit 13: 0 = No Alarm 4 Ack. required; 1 = Ack. required Bit 14: 1 = Acknowledge alarm 4 Bit 15: Spare	-	F8EA (63722) Read only Read only Read/Write Read only Read only Read/Write Read only Read only Read/Write		1

Note: PV access is Read/Write for any point configured with 'Slave Comms' as its Type or Function. Otherwise PV access is Read only.

8.4.8 IEEE AREA CHANNEL RUN-TIME DATA (Cont.)

CHANNEL 11

Parameter Name	Description	Type	Access	Start Addr. Hex (Dec)	Register Length
Channel 11 value	Current process value (PV)	Float	See note 1	F8EB (63723)	2
Channel 11 status	Channel status 0 = Good PV 5 = Ranging error 1 = Channel off 6 = Overflow 2 = Over range 7 = Bad PV 3 = Under range 8 = No data 4 = Hardware error	Enum	Read only	F8ED (63725)	1
Channel 11 Alarms	Alarm information Bit 0: 0 = Alarm 1 inactive; 1 = Alarm 1 active Bit 1: 0 = No alarm 1 Ack. required; 1 = Ack. required Bit 2: 1 = Acknowledge alarm 1 Bit 3: Spare Bit 4: 0 = Alarm 2 inactive; 1 = Alarm 2 active Bit 5: 0 = No Alarm 2 Ack. required; 1 = Ack. required Bit 6: 1 = Acknowledge alarm 2 Bit 7: Spare Bit 8: 0 = Alarm 3 inactive; 1 = Alarm 3 active Bit 9: 0 = No alarm 3 Ack. required; 1 = Ack. required Bit 10: 1 = Acknowledge alarm 3 Bit 11: Spare Bit 12: 0 = Alarm 4 inactive; 1 = Alarm 4 active Bit 13: 0 = No Alarm 4 Ack. required; 1 = Ack. required Bit 14: 1 = Acknowledge alarm 4 Bit 15: Spare	Uint16	- Read only Read only Read/Write Read only Read only Read/Write Read only Read only Read/Write Read only Read only Read/Write	F8EE (63726)	1

CHANNEL 12

Parameter Name	Description	Type	Access	Start Addr. Hex (Dec)	Register Length
Channel 12 value	Current process value (PV)	Float	See note 1	F8EF (63727)	2
Channel 12 status	Channel status 0 = Good PV 5 = Ranging error 1 = Channel off 6 = Overflow 2 = Over range 7 = Bad PV 3 = Under range 8 = No data 4 = Hardware error	Enum	Read only	F8F1 (63729)	1
Channel 12 alarms	Alarm information Bit 0:0 = Alarm 1 inactive; 1 = Alarm 1 active Bit 1:0 = No alarm 1 Ack. required; 1 = Ack. required Bit 2:1 = Acknowledge alarm 1 Bit 3:Spare Bit 4:0 = Alarm 2 inactive; 1 = Alarm 2 active Bit 5:0 = No Alarm 2 Ack. required; 1 = Ack. required Bit 6:1 = Acknowledge alarm 2 Bit 7:Spare Bit 8:0 = Alarm 3 inactive; 1 = Alarm 3 active Bit 9:0 = No alarm 3 Ack. required; 1 = Ack. required Bit 10:1 = Acknowledge alarm 3 Bit 11:Spare Bit 12:0 = Alarm 4 inactive; 1 = Alarm 4 active Bit 13:0 = No Alarm 4 Ack. required; 1 = Ack. required Bit 14:1 = Acknowledge alarm 4 Bit 15:Spare	Uint16	- Read only Read only Read/Write Read only Read only Read/Write Read only Read only Read/Write	F8F2 (63730)	1

Note: PV access is Read/Write for any point configured with 'Slave Comms' as its Type or Function. Otherwise PV access is Read only.

8.4.9 Permanent ID table

This table contains information relating to the recorder, and also gives the start address of the feature identification table (FIT).

FFF4	HHHH	Checksum
FFF3	CC26	FIT start address
FFF2	0001	Version ID
FFF1	6100 or 6180	Product ID
FFF0	0500	Company ID

Table 8.4.9 Permanent ID table

8.5 DATA TRANSMISSION

Each message (request or response) is packaged in the (MODBUS) frame shown below. The messages consist of a 7 byte prefix, followed by the function code (in hex), followed by the relevant data bytes, the number and content of which depend on the function code, as described in subsequent sections.

Byte 0	Byte 1	Byte 2	Byte 3	Byte 4	Byte 5	Byte 6	Byte 7	Bytes 8 onwards
Transaction identifier (usually 00)	Transaction identifier (usually 00)	Protocol identifier (00)	Protocol identifier (00)	Always 00	Number of bytes following	Recorder Modbus address	Modbus function code (hex)	Data (Depends on function code)

Figure 8.5 MODBUS package

Notes:

- 1 The transaction identifier has no active function - the recorder just copies the bytes from the request message to the response message.
2. The protocol identifier bytes are always zero.

FUNCTION CODES AND EXCEPTION CODES

Refer to [section 8.2.1](#) for lists of function codes and exception codes supported.

TEXT STRINGS

When sending text strings, such as Batch fields, the final character must be followed by one or two 'Null' characters. The number of bytes in the text string (including the null) must be even, even if this means adding two nulls at the end of the message instead of one.

For example, the text string: "Batch Number" should be sent as

```
Ba tc hSpace Nu mb er NullNull, or Ba tc hSpace Nu mb er SpaceNull
```

where each pair of characters occupies on 16-bit word. Similarly, the text string 'Batch Number:' would be sent as

```
Ba tc hSpace Nu mb er :null,
```

but only one Null character is required to provide an even number of bytes.

8.5.1 Function code 03

REQUEST

The bytes after the 7-byte prefix described above are:

Function code (03) (1 byte)

Register start address (2 bytes)

Word count (Total number of registers) (1 to 125 decimal; 1 to 7D hex) (2 bytes)

Thus to read Channel 5 descriptor (start address 031F - 10 registers altogether) the following request (as described in figure 8.5.1a) would be transmitted for a recorder with a Modbus address of 1:

0000000000060103031F000A

Byte 0	Byte 1	Byte 2	Byte 3	Byte 4	Byte 5	Byte 6	Byte 7	Byte 8	Byte 9	Byte 10	Byte 11
00	00	00	00	00	06	01	03	03	1F	00	0A
Transaction identifier	Transaction identifier	Protocol identifier	Protocol identifier	Always 00	Number of bytes following	Recorder Modbus address	Modbus function code (hex)	Register start address high byte	Register start address low byte	Word count high byte	Word count low byte

Figure 8.5.1a Function code 03 request example

RESPONSE

As a response to a request, the recorder returns a similar message, but the function code (03) is followed by:

Byte count (= 2 x the number of register values requested) in hex (1 byte)

Value of register at start address (2 bytes)

Value of register at start address + 1 (2 bytes)

etc.

etc.

Value of final register (2 bytes)

Thus as a response to the above request for channel 5 descriptor, the following message (as expanded in figure 8.5.1b) would be returned to the host (assuming channel descriptor to be: Channel 5 Descriptor and Modbus address = 1):

000000000170103144368616E6E656C20352044657363726970746F72

Byte 0	Byte 1	Byte 2	Byte 3	Byte 4	Byte 5	Byte 6	Byte 7	Byte 8	Byte 9	Byte 10	Byte 11
00	00	00	00	00	17	01	03	14	43	68	61
Transaction identifier	Transaction identifier	Protocol identifier	Protocol identifier	Always 00	Number of bytes following (hex)	Recorder Modbus address	Modbus function code (hex)	Byte count (No of registers x 2) (Hex)	ASCII C (Hex)	ASCII h (Hex)	ASCII a (Hex)

Byte 12	Byte 13	Byte 14	Byte 15	Byte 16	Byte 17	Byte 18	Byte 19	Byte 20	Byte 21	Byte 22	Byte 23
6E	6E	65	6C	20	35	20	44	65	73	63	72
ASCII n (Hex)	ASCII n (Hex)	ASCII e (Hex)	ASCII l (Hex)	ASCII space (Hex)	ASCII 5 (Hex)	ASCII space (Hex)	ASCII D (Hex)	ASCII e (Hex)	ASCII s (Hex)	ASCII c (Hex)	ASCII r (Hex)

Byte 24	Byte 25	Byte 26	Byte 27	Byte 28
69	70	74	6F	72
ASCII i (Hex)	ASCII p (Hex)	ASCII t (Hex)	ASCII o (Hex)	ASCII r (Hex)

Figure 8.5.1b Function code 03 response example

EXCEPTION RESPONSES

Byte 0 = Function code 83 (hex) (i.e. Hex (80 + function code))

Byte 1 = Exception code 01 (Illegal function) or 02 (Invalid data address)

8.5.2 Function code 04

This is identical with function code 03, except that 04 must be used as the function code and the exception response Function code is 84 (hex) not 83.

8.5.3 Function code 06

REQUEST

This is used to write a value to a single register. The bytes after the 7-byte prefix described in [section 8.5](#), above are:

Function code (06) (1 byte)

Register address (2 bytes)

Value to be written (2 bytes)

Thus to write a value of 80 degrees as Alarm 1 setpoint for channel 3 (register address 022F), the following request (as detailed in figure 8.5.3) would be transmitted to the recorder:

```
00000000000060106022F0050
```

Byte 0	Byte 1	Byte 2	Byte 3	Byte 4	Byte 5	Byte 6	Byte 7	Byte 8	Byte 9	Byte 10	Byte 11
00	00	00	00	00	06	01	06	02	2F	00	50
Transaction identifier	Transaction identifier	Protocol identifier	Protocol identifier	Always 00	Number of bytes following	Recorder Modbus address	Modbus function code (hex)	Register start address high byte	Register start address low byte	Value high byte (hex)	Value low byte (hex)

Figure 8.5.3 Function code 06 request/response example

RESPONSE

As a response to a request, the recorder returns a message identical with the request message.

EXCEPTION RESPONSES

Byte 0 = Function code 86 (hex) (i.e. Hex (80 + function code))

Byte 1 = Exception code 01 (Illegal function) or 02 (Invalid data address)

8.5.4 Function code 08

This is used to initiate a loop-back test. The bytes after the 7-byte prefix described in [section 8.5](#), above are:

Function code (08) (1 byte)

Subfunction code (00 00) (2 bytes)

Query data (loopback value) (HH HH) (2 bytes)

Thus to initiate a loopback test (using, as an example, 'P' 'Q' as the query data), the following request (as detailed in figure 8.5.4) is transmitted to the recorder:

```
0000000000006010800005051
```

The response to the receipt of such a message should be to 'echo' the request back to the host.

Byte 0	Byte 1	Byte 2	Byte 3	Byte 4	Byte 5	Byte 6	Byte 7	Byte 8	Byte 9	Byte 10	Byte 11
00	00	00	00	00	06	01	08	00	00	50	51
Transaction identifier	Transaction identifier	Protocol identifier	Protocol identifier	Always 00	Number of bytes following	Recorder Modbus address	Modbus function code (hex)	Subfunction code high byte	Subfunction code low byte	Query data high byte (ASCII 'P')	Query data low byte (ASCII 'Q')

Figure 8.5.4 Function code 08 (loopback test) example

8.5.5 Function code 16 (Hex 10)

REQUEST

This is used to write values to multiple registers. The bytes after the 7-byte prefix described in [section 8.5](#), above are:

Function code (10) (1 byte)

Register Start address (2 bytes)

Word count (Total number of registers to be written) (1 to 100 decimal; 1 to 64 hex) (2 bytes)

Byte count (B) (2 x word count) (1 byte)

Values to be written (2B bytes).

Thus to write "Batch Number" as batch field 1 for group 1 (start address A57F), the following message (expanded in figure 8.5.5a) would be transmitted to the recorder:

0000000000150110A57F00070E4261746368204E756D6265720000

Byte 0	Byte 1	Byte 2	Byte 3	Byte 4	Byte 5	Byte 6	Byte 7	Byte 8	Byte 9	Byte 10	Byte 11	Byte 12
00	00	00	00	00	15	01	10	A5	7F	00	07	0E
Transaction identifier	Transaction identifier	Protocol identifier	Protocol identifier	Always 00	Number of bytes to follow (hex)	Recorder Modbus address	Modbus function code (hex)	Base address High byte	Base address Low byte	Word count High byte	Word count Low byte	Byte count

Byte 13	Byte 14	Byte 15	Byte 16	Byte 17	Byte 18	Byte 19	Byte 20	Byte 21	Byte 22	Byte 23	Byte 24	Byte 25	Byte 26
42	61	74	63	68	20	4E	75	6D	62	65	72	00	00
ASCII B (Hex)	ASCII a (Hex)	ASCII t (Hex)	ASCII c (Hex)	ASCII h (Hex)	ASCII space (Hex)	ASCII N (Hex)	ASCII u (Hex)	ASCII m (Hex)	ASCII b (Hex)	ASCII e (Hex)	ASCII r (Hex)	ASCII Null	ASCII Null

Figure 8.5.5a Function code 16 request example

RESPONSE

The response message (detailed in figure 8.5.5b) after the 7-byte prefix described in [section 8.5](#), above is:

Function code 10 (1 byte)

Start address (2 bytes)

Word count (2 bytes)

Thus, the response to the above batch field request would be:

0000000000060110A57F0007

Byte 0	Byte 1	Byte 2	Byte 3	Byte 4	Byte 5	Byte 6	Byte 7	Byte 8	Byte 9	Byte 10	Byte 11
00	00	00	00	00	06	01	10	A5	7F	00	07
Transaction identifier	Transaction identifier	Protocol identifier	Protocol identifier	Always 00	Number of bytes following (hex)	Recorder Modbus Address	Modbus function code (hex)	Base address High byte	Base address Low byte	Word count High byte	Word count Low byte

Figure 8.5.5b Function code 16 response example

EXCEPTION RESPONSES

Byte 0 = Function code 90 (hex) (i.e. Hex (80 + function code))

Byte 1 = Exception code 01 (Illegal function) or 02 (Invalid data address)

Note: Function code 16 can be used to write multiple registers into the indirection table area, for example, by writing the base register address of a 32-bit channel value (e.g. channel 3 - start address: F994) into location D18B.

9 ANALOGUE OUTPUT OPTION

Up to four analogue output boards can be fitted, each of which supplies two outputs. This allows any of the recorder points to be output as a voltage or current signal, as configured. Any part of the source point's span can be mapped to the output range, and the outputs can be adjusted (as described below) to compensate for errors in the monitoring system.

9.1 SIGNAL WIRING

Figure 2.2.1d shows the output wiring for analogue output boards.

9.2 SPECIFICATION

See Annex A for the analogue output board specification.

9.3 CONFIGURATION

See [section 4.3.17](#) (output channel configuration) for details.

9.4 OUTPUT ADJUST

Notes

1. Output adjust is relevant only to output channels configured as 'V' or 'mA', not to those configured as Master Comms.
 2. Output channels can be adjusted only by users with 'Adjust I/O' access permission ([section 4.4.1](#))
-

9.4.1 Adjustment procedure

This procedure is carried out as follows:

1. Select 'Output Adjust' in the System menu.
2. Select the required channel.
3. Enter a low value for the recorder to output.
4. Observe what value the monitoring equipment is reading for this output
5. Enter this monitored value.
6. Repeat for a high value.

Note: 10% and 90% of output range are commonly used as low and high values respectively.

Figure 9.4.1 shows typical adjust pages.

9.4.2 Adjustment removal

Adjustments can be removed at any time, as follows:

1. Select 'Output Adjust' in the System menu.
2. Select the required channel.
3. Operate the 'Remove Adjust' key
4. Select 'Yes' from the resulting confirmation dialogue.

9.4 OUTPUT ADJUST (Cont.)

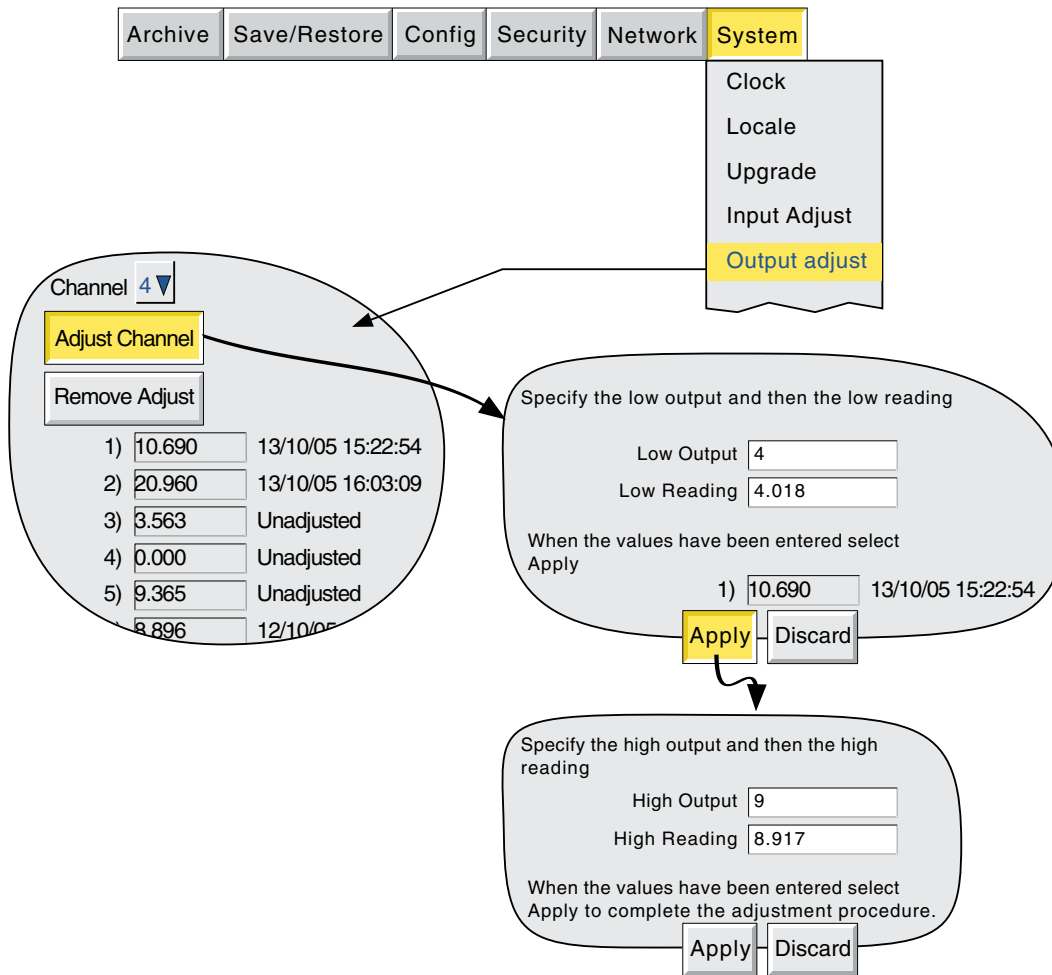

Figure 9.4.1 Typical output adjust pages

10 EVENT INPUT OPTION

10.1 INTRODUCTION

Each Event input option board offers six isolated input circuits. Inputs can be either switch closures or voltage levels.

[Section 4.3.6](#) (Event configuration) describes the use of events and how they can be combined to perform logic functions, if required. Job lists can be triggered by any event, either internal or as a result of external events wired to an event input board.

If this option is fitted, 'Event input board' appears as a event source, and the user must then specify a board number and associated input number as required.

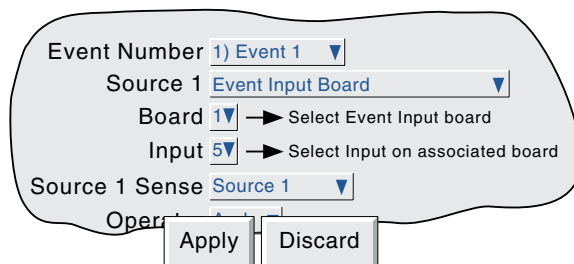

Figure 10.1 Event input selection

10.2 SIGNAL WIRING

See [figure 2.2.1d](#)

10.3 SPECIFICATION

See [Annex A](#)

11 TRANSMITTER POWER SUPPLY

11.1 INTRODUCTION

WARNING!

Transmitter power supplies must not be used with dc supply voltages.

Notes:

1. Transmitter power supplies are not suitable for use with dc or low-voltage ac supplies.
2. The transmitter power supply is available only with 100 mm. recorders.

This option consists of a circuit board, terminal block and suitable wiring inside a long terminal cover at the rear of a 100mm recorder. The board supplies three mutually isolated dc supplies (nominal 25 Volts) each of which is intended to power a single 0 to 20 mA or 4 to 20 mA current loop.

11.2 FUSING

11.2.1 Fuse Rating

The circuit board is protected by a 20 mm anti-surge (type T) fuse, the value of which depends on the supply voltage as shown in table 11.2.1, below.

Access to the output wiring and to the fuse is achieved by isolating the recorder from mains power and opening the terminal cover (after removing its securing screws). The process is fully described below.

Supply voltage	Fuse rating	Part Number
115V ac	100 mA	CH050012
230V ac	63mA	CH050630

Table 11.2.1 Transmitter power supply fuse details

11.2.2 Access to the user connections/fuse

1. Isolate the recorder from the supply voltage.
2. At the rear of the recorder remove the terminal cover securing screws (figure 11.2.2a), taking care to retain them for use in re-assembly.

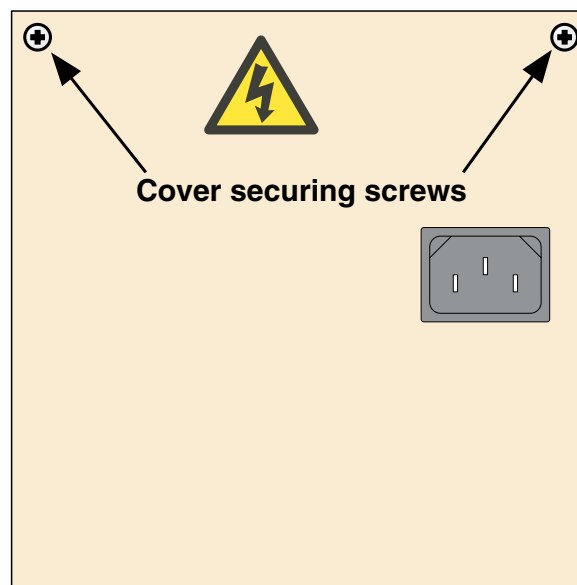

Figure 11.2.2a Retaining screw locations

11.2.2 ACCESS TO THE USER CONNECTIONS/FUSE (Cont.)

- 3 Open the cover (figure 11.2.2b) to reveal the circuit board, user connections etc. (figure 11.2.2c)

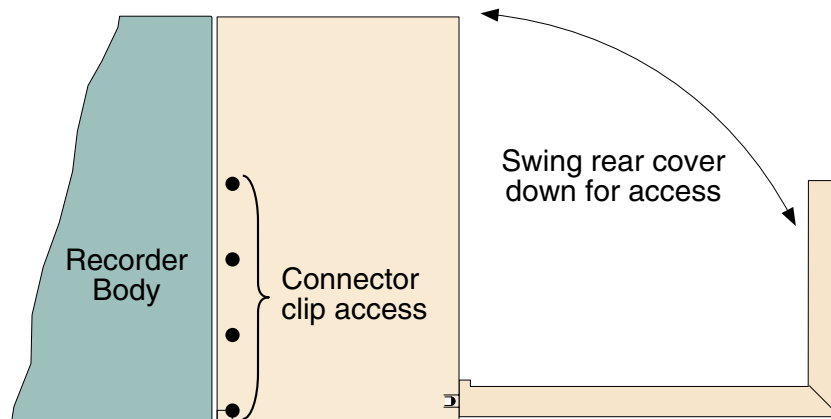

Figure 11.2.2b Opening the rear cover

- 4 The fuse is located as shown in figure 11.2.2c. User wiring to the terminal block (figures 11.2.3a/b) can be carried out now, or the terminal cover can be removed for convenience, as described in steps 5 onwards below.

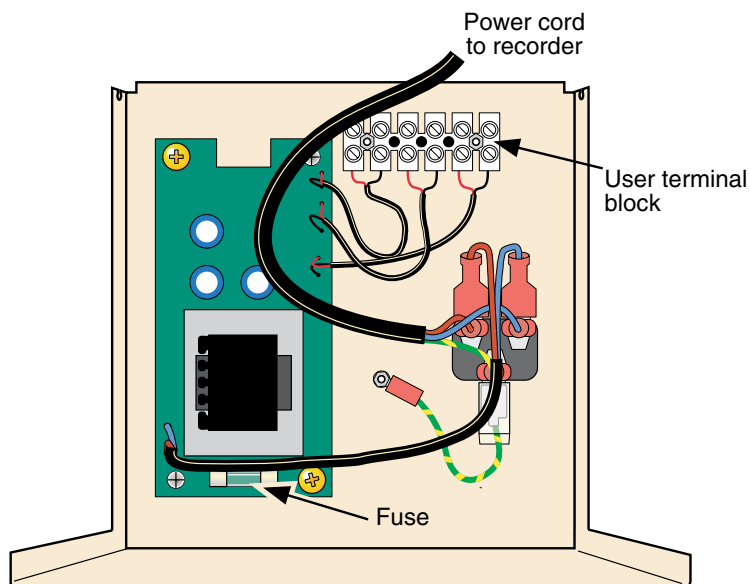

Figure 11.2.2c Fuse and User terminal block locations.

To remove the terminal cover:

- 5 Unplug the IEC connector from the rear of the recorder connector panel and remove the cable tie securing the loom to the chassis.
- 6 Close the terminal cover, and lift it off.

Note: Four apertures in each side of the terminal cover allow the user to actuate the clips which secure the i/o connectors to the rear panel of the recorder. This allows the i/o connectors to be removed if, for example, the recorder is to be removed from the panel for any reason. The positions of these apertures are shown in figure 11.2.2b (right-hand side shown; left-hand side similar).

11.2.3 User wiring

Figure 11.2.3a shows the terminal block pinout, and figure 11.2.3b shows typical applications wiring.

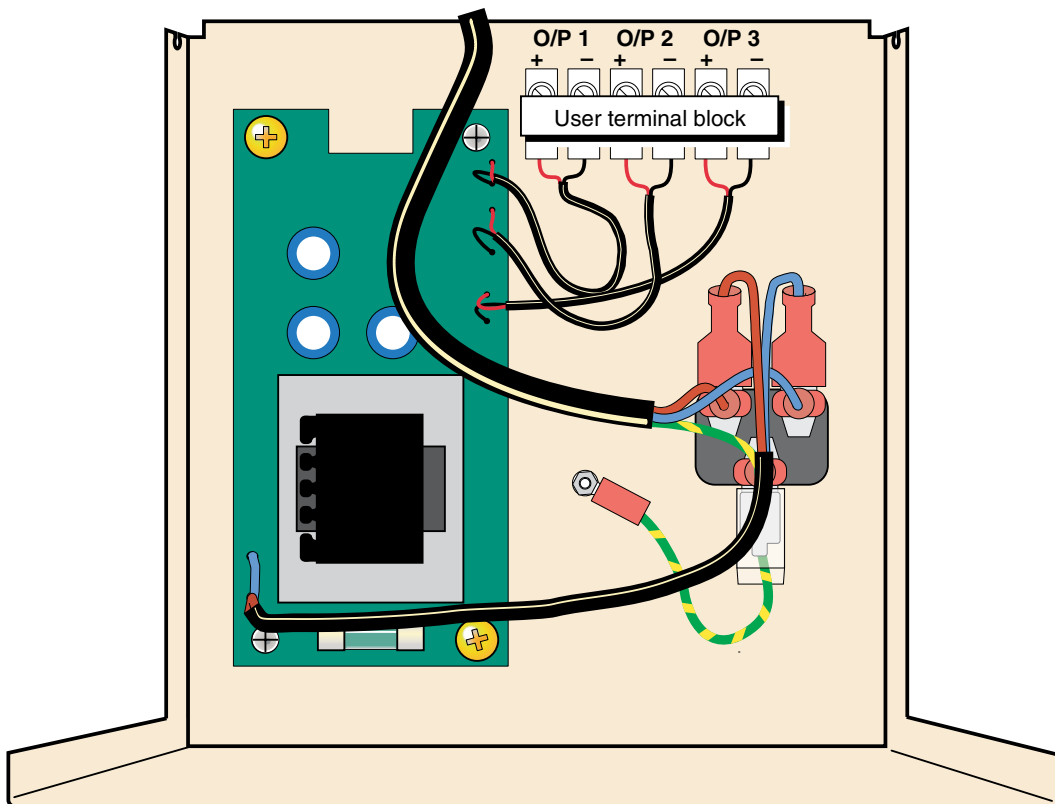
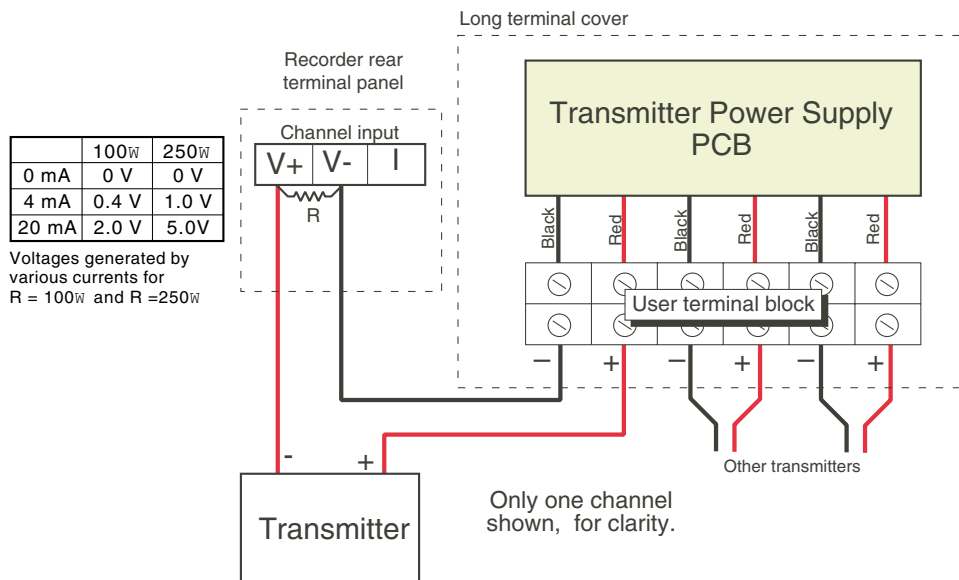

Figure 11.2.3a Terminal block wiring



R (minimum spec) = 1.4W, ± 1%. 100W or 250W as required (see table)

Figure 11.2.3b Applications wiring

12 ASCII PRINTER OUTPUT OPTION

12.1 INTRODUCTION

If the Serial Communications option is fitted, this allows the printing of messages, as and when they occur, or the printing of configurable reports as a result of job action. The recorder is set up to drive a number of recommended printers. As more printers become available, printer drivers can be imported as described in [section 12.4](#), below. For printer specification, refer to the documentation supplied with the printer.

12.2 WIRING

12.2.1 Serial communications ports

The printer is connected to one of the Serial communications ports, configured for EIA232 standard, using the Rx, Tx and common signal lines. Printer Tx must be connected to recorder Rx. Printer Rx must be connected to recorder Tx. Figure 12.2.1 shows the location of, and user connections for, the recorder ports. See also [section 2.2](#).

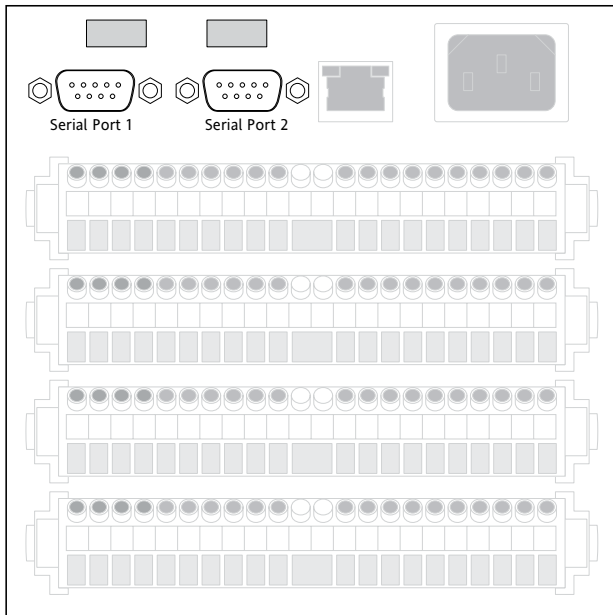
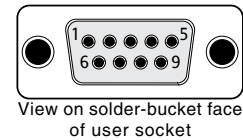

Figure 12.2.1a Serial port locations (small frame)



View on solder-bucket face of user socket

EIA232C	
Pin	Signal
1	NC
2	Rx
3	Tx
4	DTR
5	Signal ground
6	NC
7	NC
8	NC
9	5V via 1500Ω

Figure 12.2.1b Serial port pinout

12.2.2 DC connection

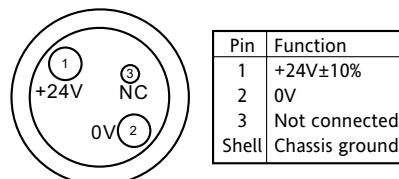

Figure 12.2.2 DC connector pinout (solder side of user connector)

12.3 CONFIGURATION

Configuration takes place in two areas viz: 'Connections' and 'Reports' ([section 12.3.2](#)).

12.3.1 Connections

Figure 12.3.1a shows the default configuration page for ASCII printer protocol. See [section 4.3.15](#) for other protocols.

Port **Serial 1** ▼

Online

Link Error Count **0**

Reset Error Count

Protocol **ASCII Printer** ▼

Connection **EIA232** ▼

Baud Rate **9600** ▼ Select required Baud rate.

Stop Bits **1** ▼ Select 1 or 2

Parity **Even** ▼

Printer Type **Star TSP600** ▼ Select printer type

Printer Name **Star TSP600(0)**

Printer Status **Not Responding**

Printer Test

Print Messages From **1) Group 1** ▼

Messages To Print

System

Alarms

Power Up

General

Batches

Logins

Apply **Discard**

Figure 12.3.1a Serial communications configuration menu

PORT

This allows serial port 1 or serial port 2 to be selected for printer configuration. Separate, independently configurable printers can be connected to the two ports, or, if only one printer is to be connected, any of the other available protocols can be selected for the non-printer port.

LINK ERROR COUNT

The counter is incremented every time there is a framing error, a parity error or a Cyclic redundancy check (CRC) error whilst communicating with the printer. The 'Reset Error Count' key is used to reset the count to zero.

Note: For instruments fitted with two printers, the count relates to the currently selected printer.

12.3.1 SERIAL COMMUNICATIONS CONFIGURATION (Cont.)

PROTOCOL

Select ASCII Printer.

BAUD RATE

Select Baud Rate setting to match that set at the Printer.

STOP BITS

Selectable as 1 or 2.

PARITY

Allows Parity to be chosen from a pick list of: None, Odd, Even. For reliable communications with the printer, it is recommended that the default parity be used.

PRINTER TYPE

Allows a printer driver to be selected for the printer connected to this port.

PRINTER NAME

Allows a name to be entered for the printer.

PRINTER STATUS

Not Responding	Printer is not communicating - check wiring
OK	Printer is connected and working correctly
Paper Low	The printer paper is getting low. The roll should be replaced as soon as possible
Paper Out	The printer paper roll is exhausted.
Unknown error	Printer is not working correctly - perhaps an unknown type of printer has been attached.

PRINTER TEST

Operating this button causes a test printout to appear at the printer, as shown in figure 12.3.1b.

PRINT MESSAGES FROM

The user can select a group for message printing. These messages are printed as they occur, and are not dependent on job action. Only those messages in the enabled categories (see 'Messages to Print' below) are printed.

MESSAGES TO PRINT

This set of enable boxes allows the user to select which, if any, messages will be printed. Enable boxes appear even if the relevant option is not fitted.

Messages are printed as they arise, but reports take precedence. For example, if a report is to be printed when channel one goes into alarm, and 'Alarms' is enabled in the 'Messages To Print' area, then the Report is printed before the alarm message.

Note: Messages will be printed only if they are enabled in the relevant part of the recorder's configuration. For example: 'Logins' messages will be printed only if 'Record Logins' is enabled in the unit's 'Security' configuration (section 4.4), and 'Alarms' messages will be printed only if 'Alarm Message' and/or 'Ack Message' are enabled in the relevant group's configuration (section 4.3.2).

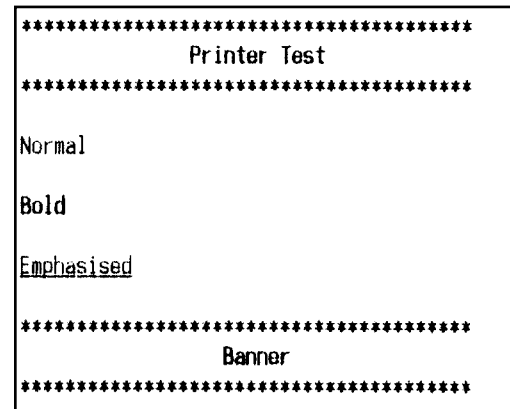

Figure 12.3.1b Test printout

12.3.2 Reports configuration

This allows the user to configure up to 10 'reports' for printing by the ASCII printer as a result of job action. Figure 12.3.2a shows a typical configuration page, accessed from the CONFIG button 'Reports' item.

Report 1) Report 1 ▼

Descriptor Report 1

Number of Fields 6 ▼

Field 1 Type Date & Time ▼

Style Normal ▼

Field 2 Type Text ▼

Text

Style Bold ▼

Field 3 Type Process Value ▼

Point Channel 1 ▼

Style Emphasised ▼

Field 4 Type Batch Field 1 ▼

Style Banner ▼

Field 5 Type 1) Message ▼

Style Normal ▼

Field 6 Type Line Feed ▼

Line Feed 1 ▼

Apply Discard

Figure 12.3.2a Reports Configuration

REPORT

Allows the user to select the required report number for configuration.

DESCRIPTOR

A name for the Report can be entered here.

NUMBER OF FIELDS

Select 0 to 10 for the number of items to be included in the report.

FIELD N TYPE

N = 1 to the number of fields selected in the previous item.

Date & Time	Causes the time and date of report generation to be included in the report
Text	Allows the user to enter a text message of up to 60 characters.
Process value	Allows a specified point's process value (including descriptor and units) to be included in the report
Batch Field 1	Batch field 1 can be included in the report. See section 4.3.10 for Batch details.
Message	A message can be selected for inclusion in the report. See section 4.3.8 for details of message configuration.
Line Feed	Allows one or more blank lines to be left. This can be useful at the end of a report.

12.3.2 REPORTS CONFIGURATION (Cont.)

STYLE

See figure 12.3.2b for examples of 'Normal', 'Bold', 'Emphasised' and 'Banner' print styles. For all styles, if the text is too long to fit on one line it 'wraps round' as shown (for normal style) in figure 12.3.2b, below.

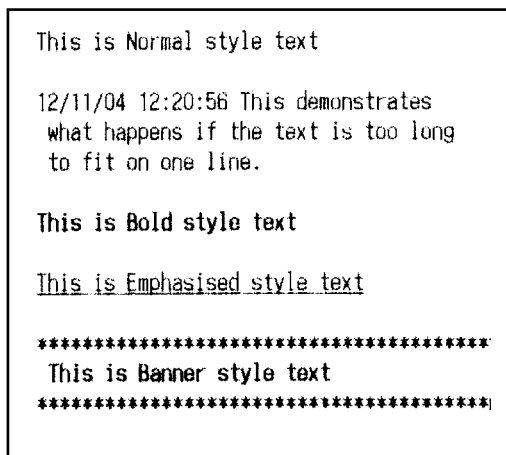

Figure 12.3.2b Text style examples

POINT

Allows a point to be chosen when 'Process value' has been selected as Field Type. The point is selected from a pick-list containing all the input channels, derived channels, totalisers etc. in the instrument.

LINE FEED

Appears only when 'Line Feed' has been chosen as Field Type. Allows the user to enter the required number of blank lines (up to 10) which are to be inserted.

12.3.3 ASCII Input Filtering

An enhancement has been added to the ASCII input feature in instruments with software versions 5.4 upwards. This feature provides a number of text filters, each with their own timeouts, to be applied to the ASCII input so that only specific text strings are recognised. The feature has been designed for use, in particular, with GPS systems to allow only relevant data to be logged.

TEXT FILTERS

Three text filters are provided each up to 20 characters long. Only messages containing configured patterns will be processed i.e patterns that are not blank strings. Each of these has a timeout of up to 9999 seconds, only allowing filtered messages through at this rate. If this is set to 0 all the messages for the filter will be processed.

CONFIGURATION

In configuration level set the 'Protocol' parameter to ASCII (input) as shown in the screen view on the next page. Select the serial port and communications parameters as described in the previous sections.

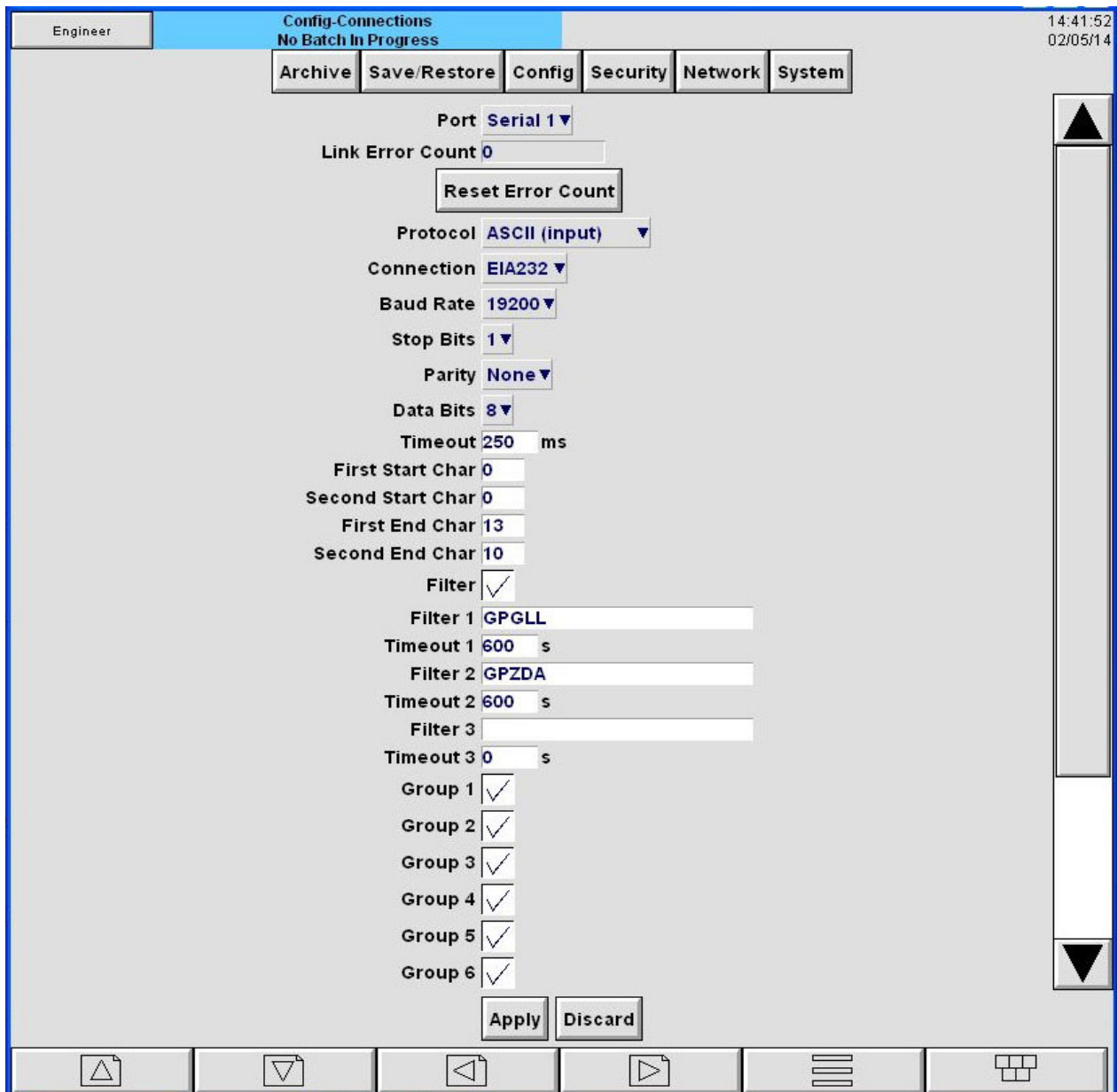

To enable the feature the 'Filter' parameter must be ticked. The filter parameters (1 to 3) will then appear. This is the default.

In the example shown above:

The instrument will respond to incoming messages which contain the characters 'GPGLL' as set in Filter 1 and 'GPZDA' as set in Filter 2.

Filter 3 is not being used as it is a blank string.

Note: The supported characters for filter strings are ASCII 0x20 to 0x7F excluding the \ and , characters.

When used with an unprogrammable receiver which is generating GPS messages typically every second, the 'Timeout' parameter will typically be set to 600 seconds to record required messages every 10 minutes.

When used with a programmable receiver which is configured to generate GPS messages typically every 10 minutes, the 'Timeout' parameter can be set to 0 to disable it, so as to record required messages every 10 minutes.

'Timeout' can be set to different rates for each filter in which case the data will be recorded at the rates set for each filter.

When the instrument reboots the filter timeouts will reset, so the first message received will be recorded (in a new history file), the timeouts will then come into effect.

Filter timeouts will also be reset when the instrument is reconfigured or the clock is changed as per existing "ASCII input" parameters.

12.4 IMPORTING PRINTER DRIVERS

The importing of new printer drivers is carried out from the SAVE/RESTORE button menu, fully described in [section 4.2](#). Before a printer driver can be 'imported', it must be available from the recorder's Flash memory, from an SD or Flash card, from a USB memory stick or, for Bridge users, from the host PC. Printer driver files have the suffix .uhi.

Figure 12.4 depicts the process for a recorder.

When using a PC as the operator interface, the detailed appearance of the Host PC browse window depends on the Windows version in use.

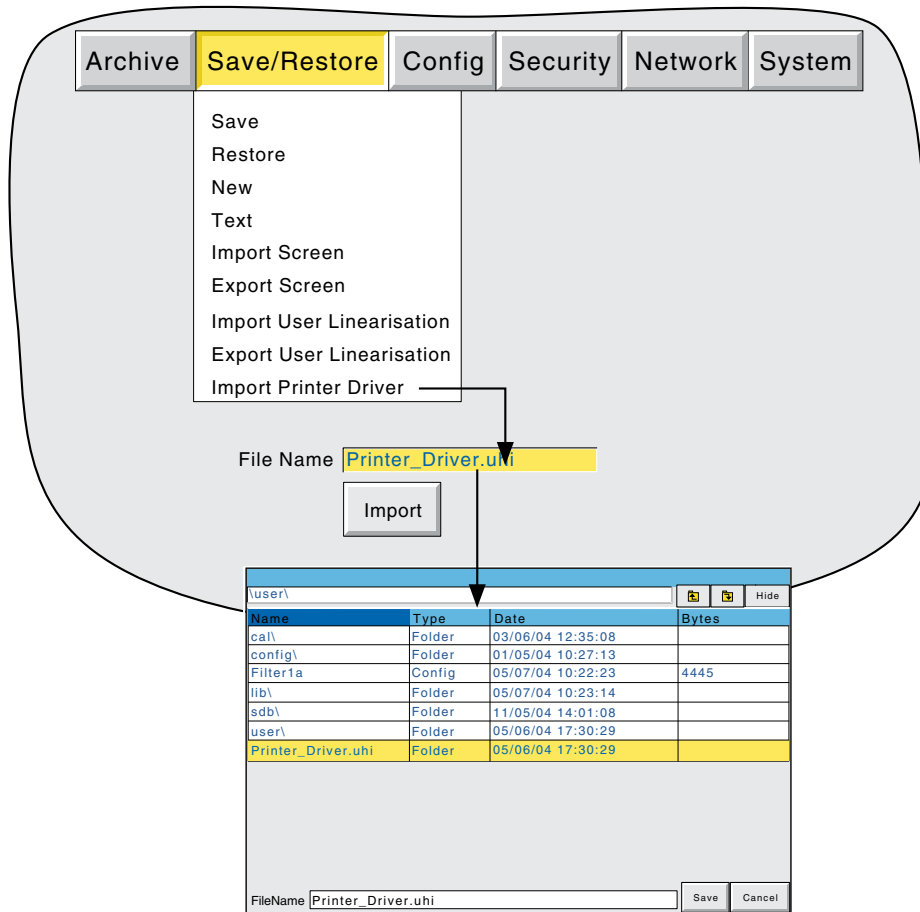

Figure 12.4 Importing a printer driver

12.5 REPORT EXAMPLE

This example shows how to configure a report to be printed if any of channel 1 to channel 4 go into alarm. It is assumed that the Serial comms link with the printer has been successfully established.

The report is to include the process values of channels 1 to 4 and the time and date.

Note: The example assumes that the channels being configured are in their factory default state. Configuration items not mentioned in the example (e.g. Scale Low) should be left at their default values.

12.5.1 Group Configuration

Refer to [section 4.3.2](#), as necessary.

GROUP NUMBER 1

Descriptor = Colour mix.

Alarm message = Disable

Deselect all points except Channels 1 to 4.

12.5.2 Channel configuration

Refer to [section 4.3.3](#) as necessary

CHANNEL 1

Input Type = Test

Scale High =100

Units = %

Descriptor = Red

Alarm 1

Enable = Unlatched

Type = Absolute low

Threshold = 10

CHANNEL 2

As channel 1, except

Descriptor = Blue

CHANNEL 3

As channel 1, except

Descriptor = Green

CHANNEL 4

As channel 1, except

Waveform = Sine 4 minutes

Descriptor = Orange

12.5.3 Event Configuration

Refer to [section 4.3.6](#) as necessary

EVENT NUMBER 1

Source 1 = Unack'd Alarm on Group

Descriptor = Paint low

Job number 1

Category = Report

Send Report to = Select required printer

Report = 1) report 1

On = Active

12.5.4 Report Configuration

Descriptor = Paint Low

Number of fields = 8

Field 1 Type = Text

Text = 'Paint Low Warning'

Style = Banner

Field 2 Type = Line Feed

Line Feed = 2

Field 3 Type = Date & Time

Style = Normal

Field 4 Type = Process Value

Point = Red

Style = Normal

Field 5 Type = Process Value

Point = Blue

Style = Normal

Field 6 Type = Process Value

Point = Green

Style = Normal

Field 7 Type = Process Value

Point = Orange

Style = Normal

Field 8 Type = Line feed

Line Feed = 5

12.5.5 Serial Communications Configuration

Enable 'Alarms' in the 'Messages To Print' area.

Press 'Apply'.

A sample Printout is shown in figure 12.5.5, in which it can be seen that it was the Orange channel which triggered the warning.

Note: In the example above the event trigger is 'Unacknowledged alarm'. This means that once the first channel alarm becomes active and the relevant report printed, then no further reports will be initiated until the alarm is acknowledged, no matter how many other channel alarms go active. If, however, an unlatched alarm becomes inactive, this is the equivalent of its being acknowledged as far as report printing is concerned. For latched alarms, each alarm must be acknowledged before further reports can be triggered.

```
*****  
Paint Low Warning  
*****  
  
03/11/04 13:58:03  
Red 73.0625%  
Blue 22.9688%  
Green 20.3125%  
Orange 9.8397%  
  
03/11/04 13:58:03 Alarm(s) on 4(1)
```

Figure 12.5.5 Example printout

12.6 TSP600 SWITCH SETTINGS

This section applies only to the Star TSP600 Printer.

The DIP switches are revealed by removing the access panel located on the underside of the printer. The two switches appear as shown in figure 12.6a, and their elements should be configured as shown in figure 12.6b. See SW1/SW2 details in the TSP600 'User's guide' for details.

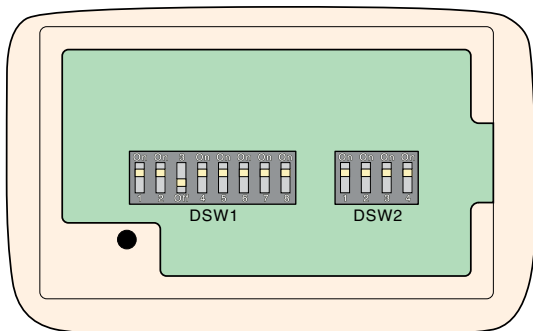

Figure 12.6a DIP switch access

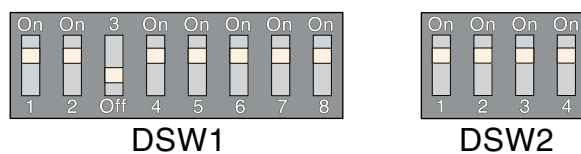

Figure 12.6b DIP switch element configuration

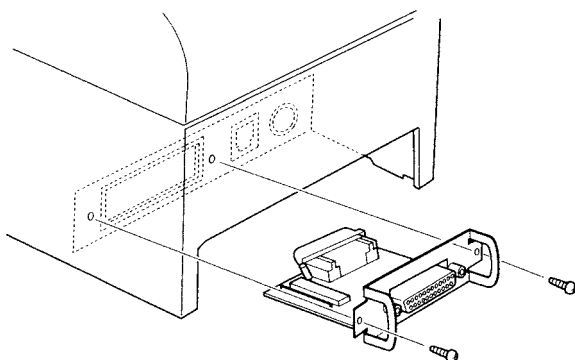

Figure 12.6c SW3 location

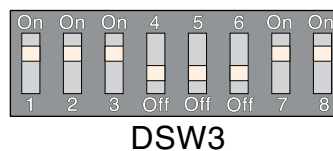

Figure 12.6d SW3 settings

The illustrated switch settings (segments 4, 5 and 6 'Off'; all other segments 'On') give the following parameter values: Baud Rate = 9600, Data bits = 8, Parity = Even, Handshake = Xon/Xoff.

Settings other than these may result in no communications or unreliable communications with the printer. See the TSP600 'User's guide' for more details of SW3.

13 PORTABLE CASE OPTIONS

Note: Portable case options are available only for the small frame recorder.

The various options described below come provided in a rugged carrying case as depicted in figure 13, below,

It is possible that input/output circuits can carry high voltages, and this might prove dangerous if the safety earth connection to the recorder is not in place (e.g. the plug is pulled out) at any time whilst such hazardous voltages are present. Therefore, the following warning must be complied with:

WARNING

For portable case instruments only:

All I/O connections must be Low Voltage (i.e. maximum 33V ac RMS, 46.7V ac peak, 70V dc) unless the integrity of the instrument safety earth is maintained for as long as the I/O is connected to the recorder.

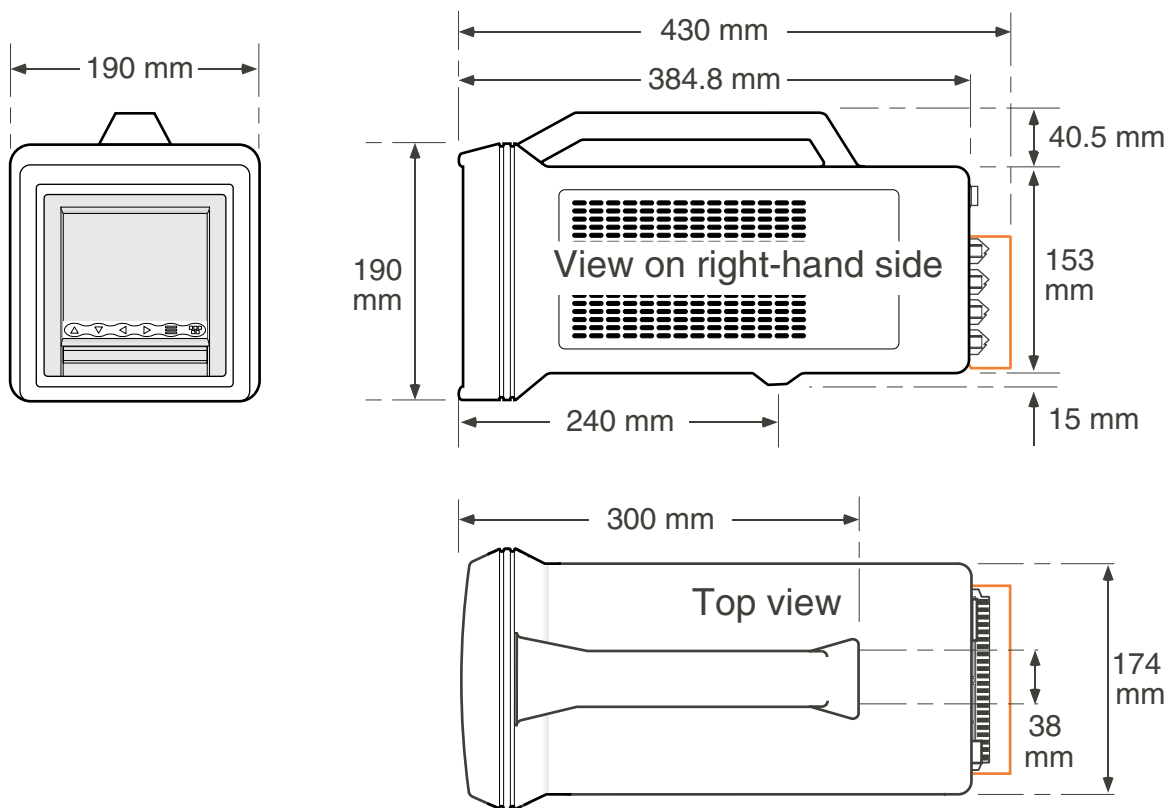

Figure 13 Portable case dimensions

13.1 BASIC OPTION

13.1.1 Introduction

The basic portable case option provides 6 or 12 input channels with up to four option boards, or 18 input channels and up to two option boards.

13.1.2 Wiring

Figure 13.1.2a, below, gives alternative back panel connector layouts for the 12-input and 18-input recorder options.

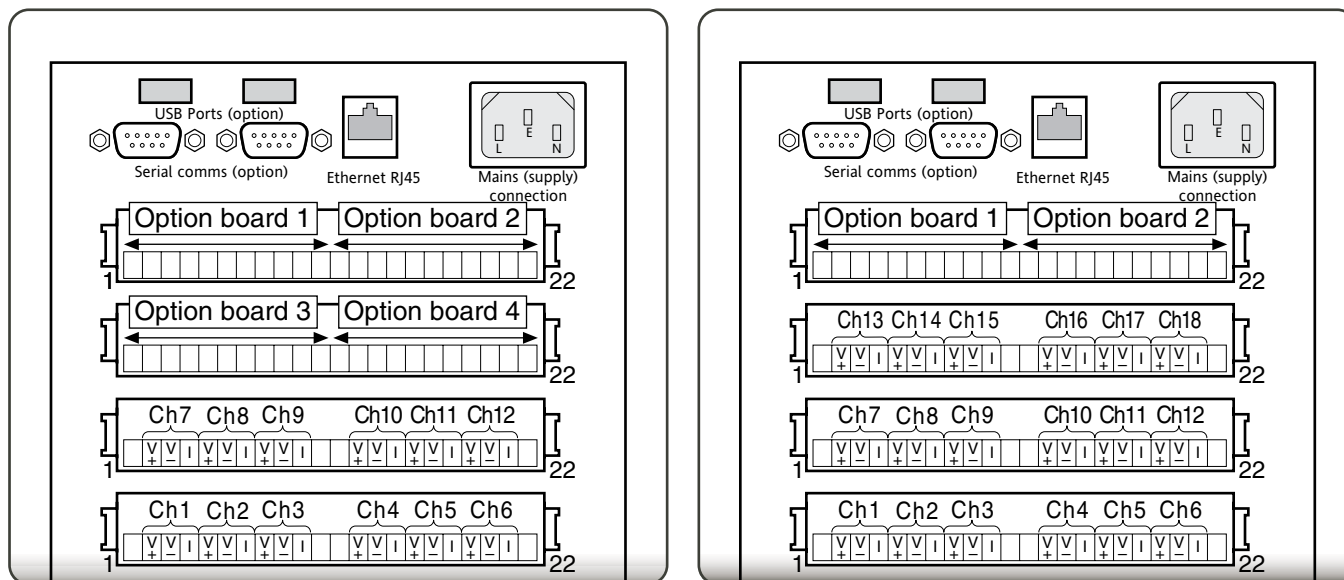

Figure 13.1.2a Back panel connector details.

SUPPLY VOLTAGE

Caution

Before powering the recorder, check that the supply voltage to be applied lies within the range specified on the serial number label on the underside of the case.

As shown in Figure 13.1.2a, above, the line supply is terminated using an IEC connector at the rear of the case. A socket is required to mate with the plug fitted at the recorder. Minimum recommended conductor size is 16/0.2 (0.5mm²) (20AWG).

SIGNAL WIRING

Input and typical options pinouts are as shown in figure 13.1.2a, above. For full I/O wiring details, refer to [Section 2.2](#).

INTERNAL WIRING

Figure 13.1.2b, below, shows details of the wiring between the portable case rear panel and the recorder rear panel.

13.1.2 WIRING (Cont.)

Note: For the sake of clarity, the Serial Communications and USB option wiring are not shown.

Note: For 18 input channels, Option boards 3/4 are replaced with input board 3, including associated CJ sensor

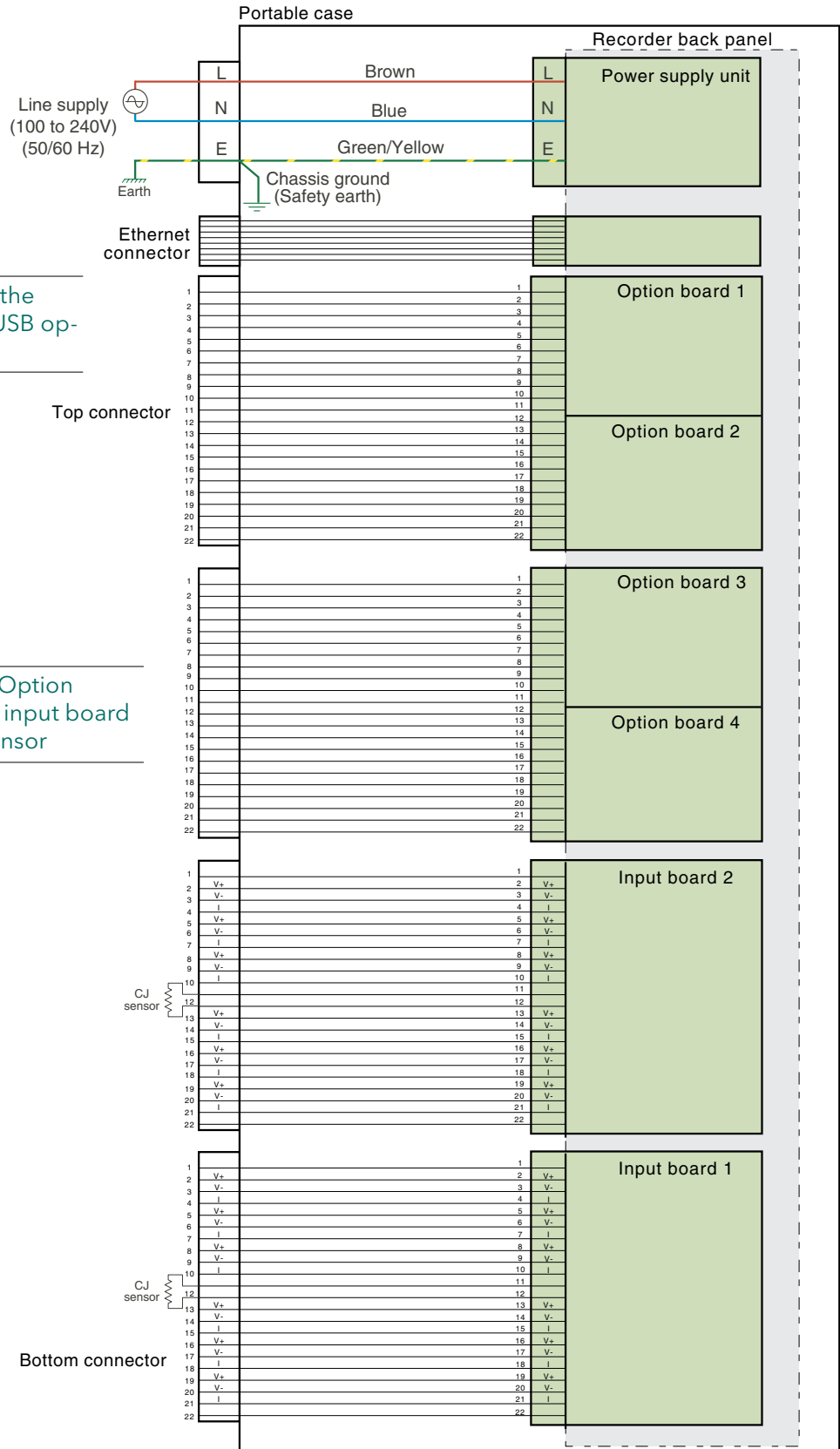

Figure 13.1.2b Basic option internal wiring

13.2 TRANSMITTER POWER SUPPLY (TRS) OPTION

This option is identical with the 6/12 channel basic option described in [section 13.1](#), above except that one of the option slots is used for TRS output. The TRS pinout is given in figure 13.2, below.

Note: Only one transmitter power supply can be fitted in the portable case, and may be terminated only at option slot 2 OR option slot 4 (if available).

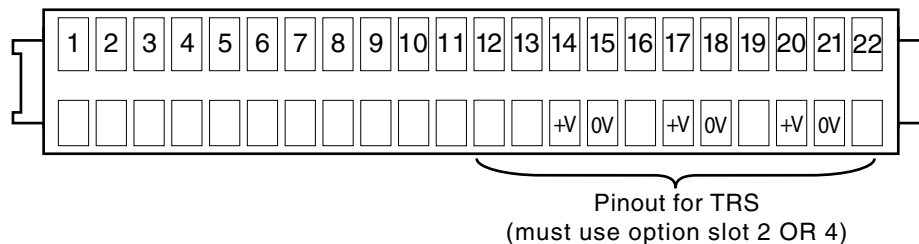

Figure 13.2 TRS pinout

13.2.1 Internal wiring

Figure 13.2.1 shows wiring details between the recorder and the back panel connectors.

13.2 TRS OPTION (Cont.)

Note: For the sake of clarity, the Serial Communications and USB option wiring are not shown.

Note: For 6 or 12 input channel recorders the transmitter power supply may use either option board 2 connector or (as shown) the option board 4 connector. For 18 input channel instruments, the transmitter power supply must use option board 2 connector, because option board 3 and 4 slots (and associated connector) are occupied by input board 3 and its cold junction sensor.

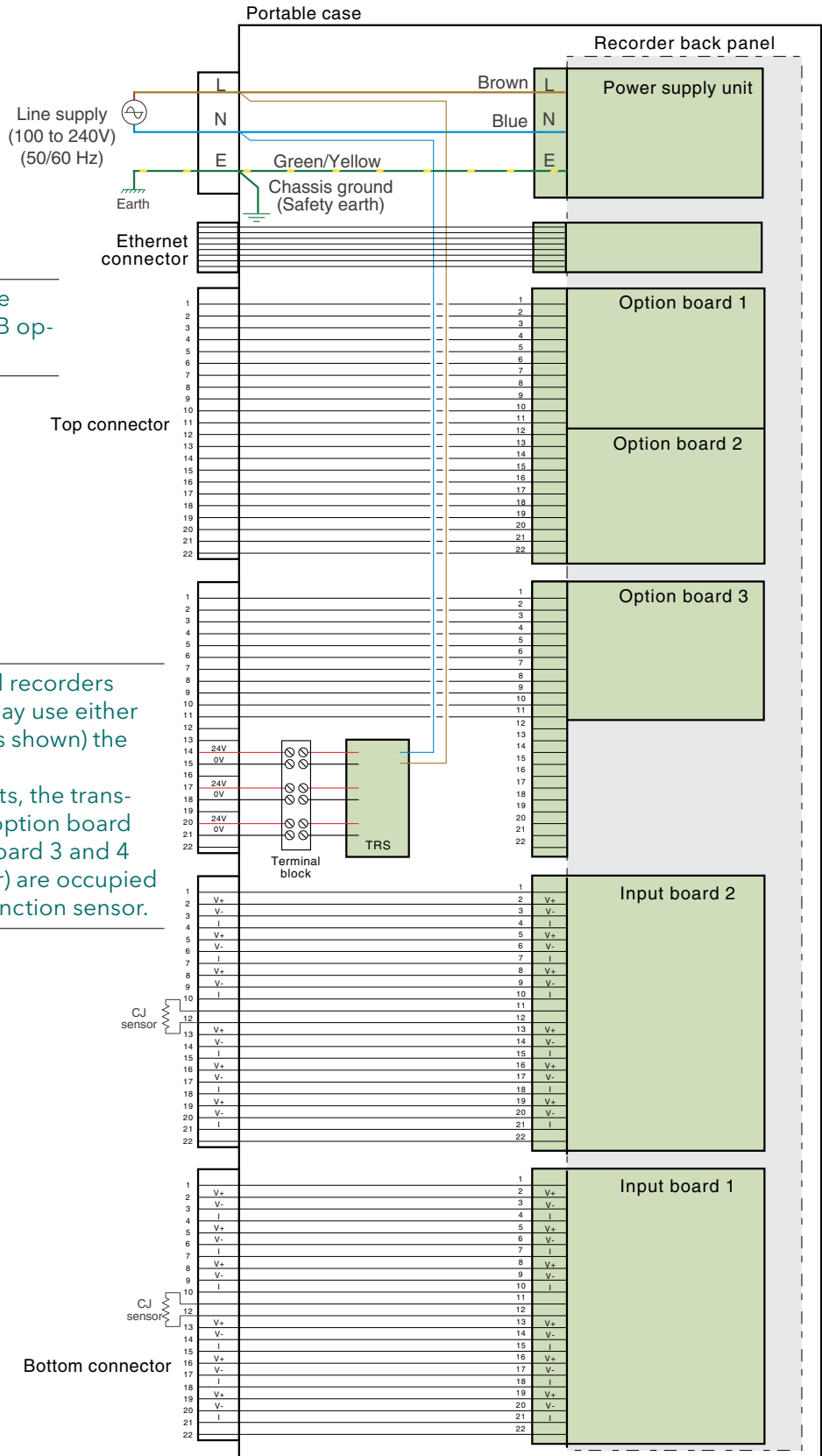

Figure 13.2.1 Typical internal wiring

13.3 HTM2010 QUARTERLY TEST KIT

13.3.1 Introduction

This option is supplied as a six-channel, 100 mm recorder in a rugged portable case, configured for five type-T thermocouples and one pressure transducer. The option comes complete with pressure transducer, insertion tubes and miniature plugs for type T thermocouples. As supplied, the recorder is for use with small, unwrapped utensil sterilisers. The default configuration for the thermocouples is: Function = Type T, Input range = 0 to 150°C, and for the transducer: Input range = -1 to + 3 bar.

13.3.2 Wiring

SUPPLY VOLTAGE

Caution

Before powering the recorder, check that the supply voltage to be applied lies within the range specified on the serial number label on the underside of the case.

As shown in Figure 13.3.2a, below, the line supply is terminated using an IEC connector at the rear of the case. A socket is required to mate with the plug fitted at the recorder. Minimum recommended conductor size is 16/0.2 (0.5mm²) (20AWG).

SIGNAL WIRING

Signal wiring consists of wiring the thermocouples to the relevant plugs and plugging them and the (pre-wired) pressure transducer in. Figure 13.3.2a shows the arrangement of the sockets at the rear of a six-channel recorder (12 channel similar), and of an 18-channel recorder. Figure 13.3.2b shows the wiring of the thermocouple plugs.

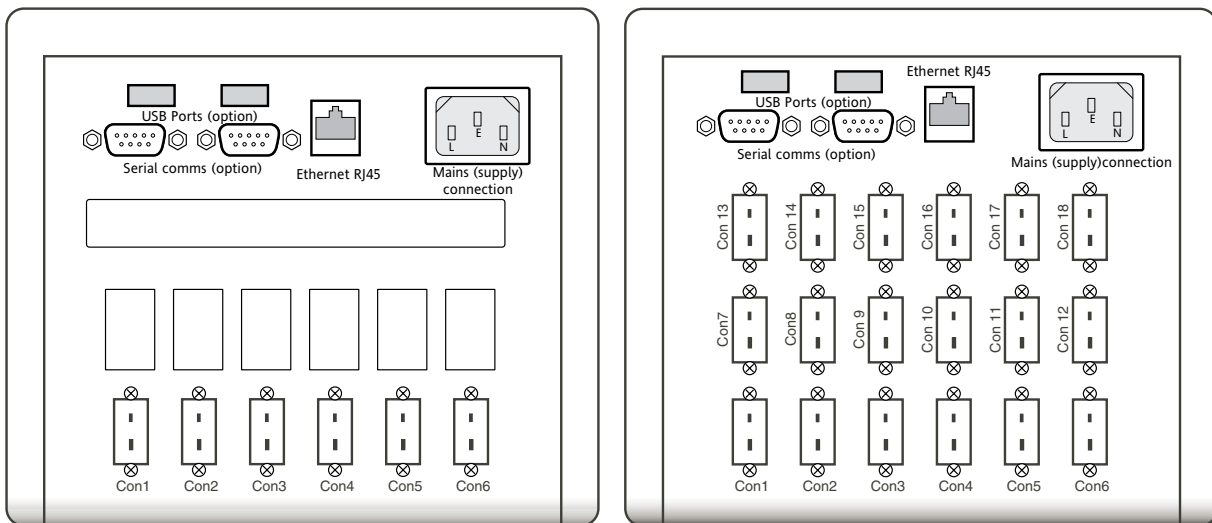
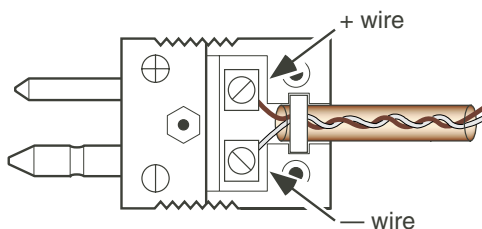

Figure 13.3.2 a Connector locations



	T/C type T colours	
	BS4937:1993 IEC584-3:1989 (Current)	BS1843:1952 (Superseded)
+	Brown	White
-	White	Blue
Sheath	Brown	Blue

Figure 13.3.2b Thermocouple plug wiring (cover removed for clarity)

13.3.2 WIRING (Cont.)

INTERNAL WIRING

Figure 13.3.2c shows the internal wiring between the portable case connectors and the recorder rear panel for a 6 input option..

Note: For the sake of clarity, the Serial Communications and USB option wiring are not shown.

Note: For the sake of clarity, only one input board shown. Two and three input board wiring similar.

If fitted, input board 2 channels 1 to 6 are wired to connectors 7 to 12 respectively; input board 3 channels 1 to 6 wired to connectors 13 to 18 respectively.

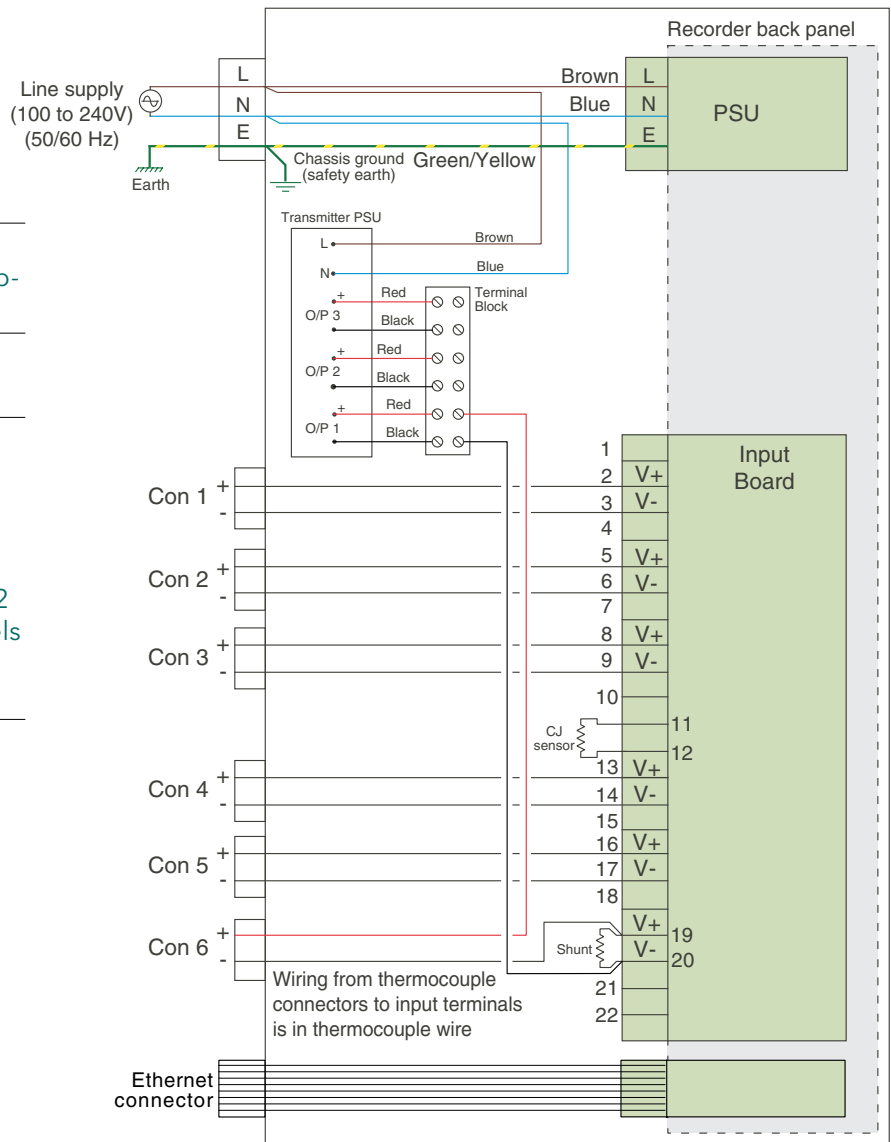

Figure 13.3.2c Internal wiring details

13.3.3 Specification

Information additional to the general specification in Annex A.

Pressure transducer	
Input range	-1 to 3 Bar G
Output range	4 to 20 mA
Supply voltage range	12 to 32V dc
Non linearity/hysteresis	≤0.25% span
Long term stability	0.1% in 12 months

Safety isolation	DC to 65 Hz: BS EN61010 (Installation category II; Pollution degree 2)
Channel to channel:	33V ac RMS, 46.7V ac peak, or 70V dc to earth
Channel to ground:	33V ac RMS, 46.7V ac peak, or 70V dc to earth

13.4 THERMOCOUPLE OPTION

13.4.1 Introduction

This option allows the connection of up to 12 type J, K or T thermocouples together with up to two option boards, or up to 18 thermocouples with no option boards. Transmitter power supply is not available with this option.

The type of thermocouple (the same for all channels) must be specified at time of order. Each thermocouple input channel will be configured at the factory for the specified type of thermocouple and will be set to a range of 0 to 100 degrees Celsius.

Thermocouple-style connectors with copper terminals can also be fitted, for use with non-thermocouple inputs. For such channels the recorder is pre-configured as: Function = Linear, Input range = 0 to 1 Volt.

13.4.2 Wiring

SUPPLY VOLTAGE

Caution

Before powering the recorder, check that the supply voltage to be applied lies within the range specified on the serial number label on the underside of the case.

As shown in Figure 13.4.2a, below, the line supply is terminated using an IEC connector at the rear of the case. A socket is required to mate with the plug fitted at the recorder. Minimum recommended conductor size is 16/0.2 (0.5mm²) (20AWG).

SIGNAL WIRING

Signal wiring consists of connecting the transducer wires into the correct type of plug, and inserting the plugs into the relevant socket at the rear of the recorder.

Figure 13.4.2a shows the arrangement of the connectors at the rear panel for 12 and 18 channel versions. Figure 13.4.2b shows thermocouple wiring details, and Figure 13.4.2c shows the wiring between the portable case rear panel and the recorder for a 12 thermocouple option.

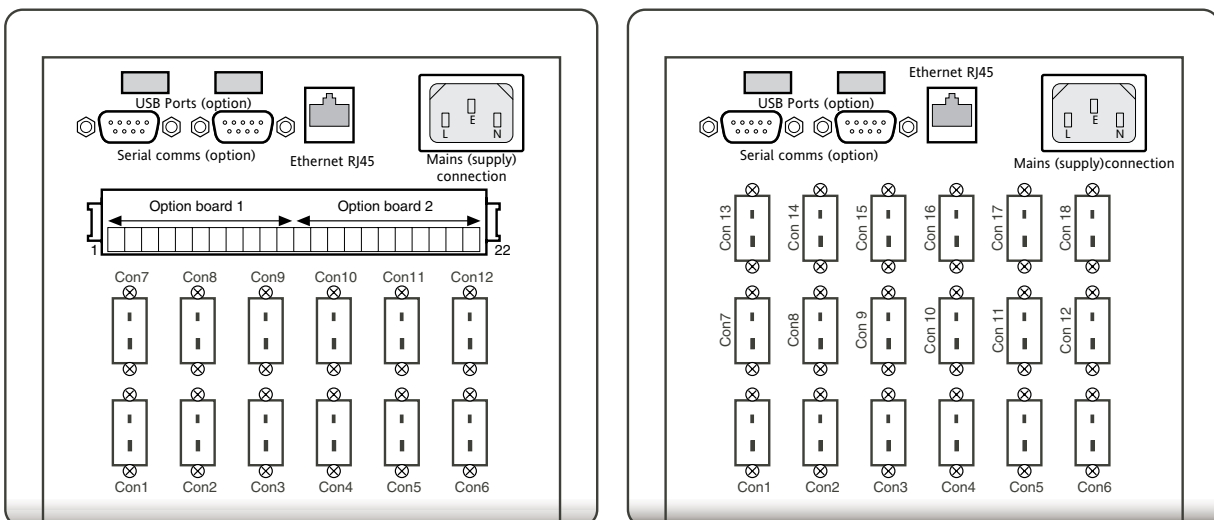
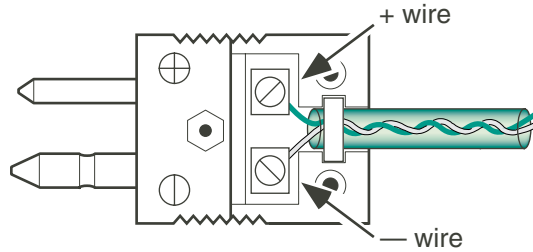

Figure 13.4.2a Rear panel connector locations (typical)

13.4.2 WIRING (Cont.)

THERMOCOUPLE WIRING



	T/C type J colours		T/C type K colours		T/C type T colours	
	BS4937:1993 IEC584-3:1989 (Current)	BS1843:1952 (Superseded)	BS4937:1993 IEC584-3:1989 (Current)	BS1843:1952 (Superseded)	BS4937:1993 IEC584-3:1989 (Current)	BS1843:1952 (Superseded)
+	Black	Yellow	Green	Brown	Brown	White
-	White	Blue	White	Blue	White	Blue
Sheath	Black	Black	Green	Red	Brown	Blue

Figure 13.4.2b Thermocouple wiring details.

13.4.2 WIRING (Cont.)

Note: For the sake of clarity, the Serial Communications and USB option wiring are not shown.

Note: Two input board (12 t/c) wiring shown.
 One input board version (6t/c) similar but input board two and associated wiring and connectors are not fitted.
 Three input board (18 t/c) similar, but with option boards 1 and 2 being replaced by the third i/p board and the 22-way connector being replaced by thermocouple connectors CON 13 to CON18. Input board 3 channels 1 to 6 are wired to CON 13 to CON 18 respectively.

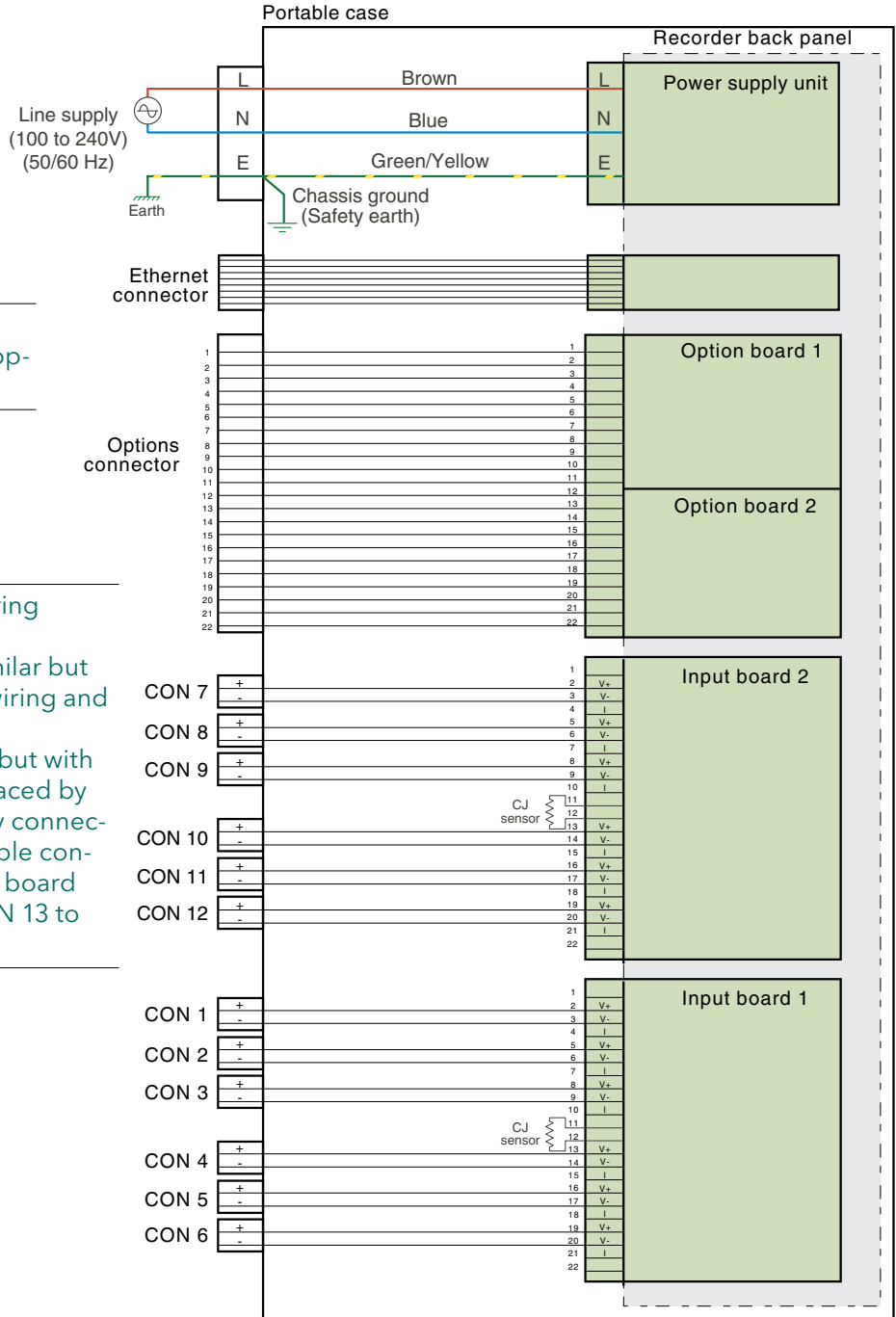

Figure 13.4.2c Internal wiring

13.4.3 Specification

Information additional to the general specification in Annex A.

Safety isolation

	DC to 65 Hz: BS EN61010 (Installation category II; Pollution degree 2)
Channel to channel:	33V ac RMS, 46.7V ac peak, or 70V dc to earth
Channel to ground:	33V ac RMS, 46.7V ac peak, or 70V dc to earth

13.5 LOW SUPPLY VOLTAGE OPTION*

Some of the portable case options described in this manual can be ordered for use with 24V (nom.) supply voltages. In such cases, the supply voltage part of the wiring diagrams is replaced with that shown in figure 13.5a unless otherwise stated. The low voltage supply is terminated by a three pin plug, as shown in figure 13.5b.

Note: The polarity of the dc supply is not critical, but the recorder operates more efficiently with the polarity shown below

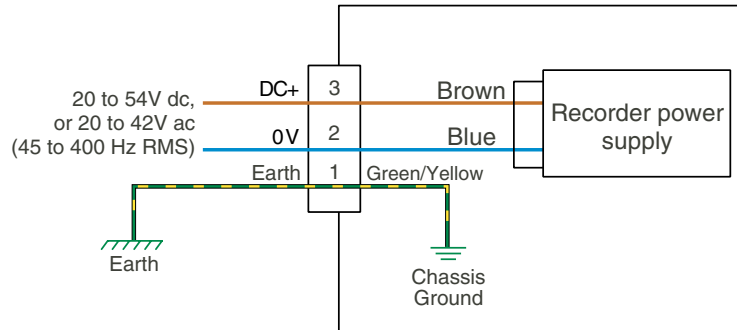

Figure 13.5a Internal wiring for low voltage options

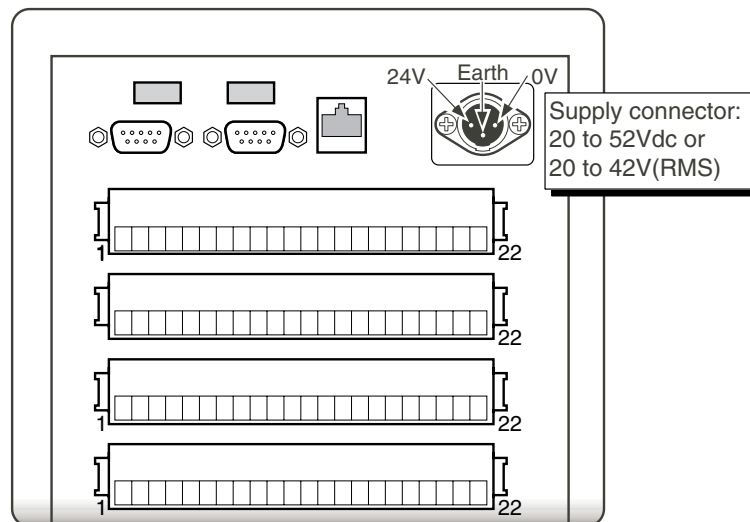

Figure 13.5b Low supply voltage connector details

* Consult factory for availability

13.6 REMOTE CJC BLOCK OPTION

13.6.1 Introduction

This option allows up to 15 thermocouples of any type(s) to be connected to the recorder using miniature compensating connectors. Thermocouples may be connected directly, or by using extension compensating cable.

Each row of five sockets has an associated aluminium bar, to which is bonded a resistance temperature detector (RTD) which acts as a cold junctions sensor, connected to the sixth channel of each of the three input boards. For this reason, connector numbers 6 to 15 do not match the input channel numbering, but the recorder configuration names the channels in an unambiguous way, to reduce confusion. Table 13.6.1 gives details.

Connector 1 - Channel 1	Connector 6 - Channel 7	Connector 11 - Channel 13
Connector 2 - Channel 2	Connector 7 - Channel 8	Connector 12 - Channel 14
Connector 3 - Channel 3	Connector 8 - Channel 9	Connector 13 - Channel 15
Connector 4 - Channel 4	Connector 9 - Channel 10	Connector 14 - Channel 16
Connector 5 - Channel 5	Connector 10 - Channel 11	Connector 15 - Channel 17

Table 13.6.1 Connector/channel cross reference

13.6.2 Wiring

Caution

1. Before powering the recorder, check that the supply voltage to be applied, lies within the range specified on the serial number label on the underside of the case.
2. Thermocouples must not be attached to voltages greater than 24V,

As shown in Figure 13.6.2a, below, the line supply is terminated using an IEC connector at the rear of the case. A socket is required to mate with the plug fitted at the recorder. Minimum recommended conductor size is 16/0.2 (0.5mm²) (20AWG).

SIGNAL WIRING

Signal wiring consists of connecting the transducer wires into the correct type of plug (figure 13.6.2b), and inserting the plugs into the relevant sockets at the rear of the recorder.

Figure 13.6.2a shows the arrangement of the connectors at the rear panel, and Figure 13.6.2c shows the wiring between the portable case rear panel and the recorder.

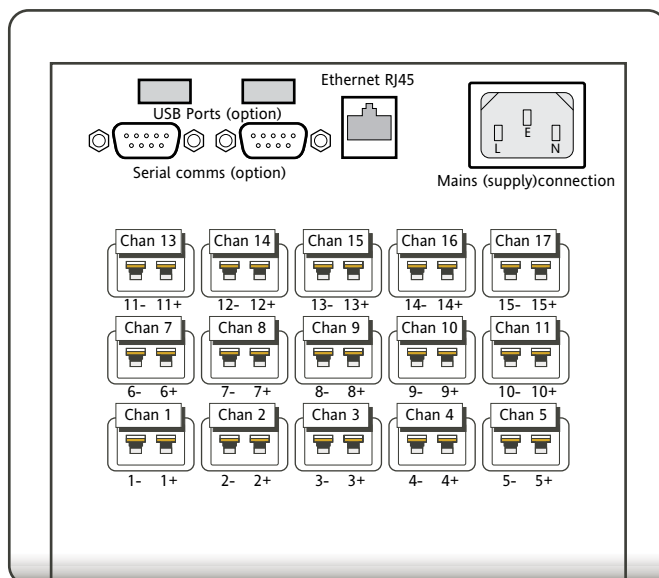

Figure 13.6.2a Rear panel connector layout

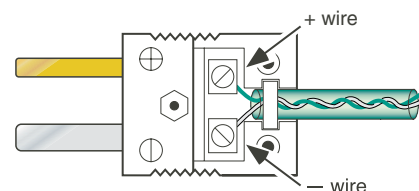

Figure 13.6.2b Connector detail (typical)

13.6.2 WIRING (Cont.)

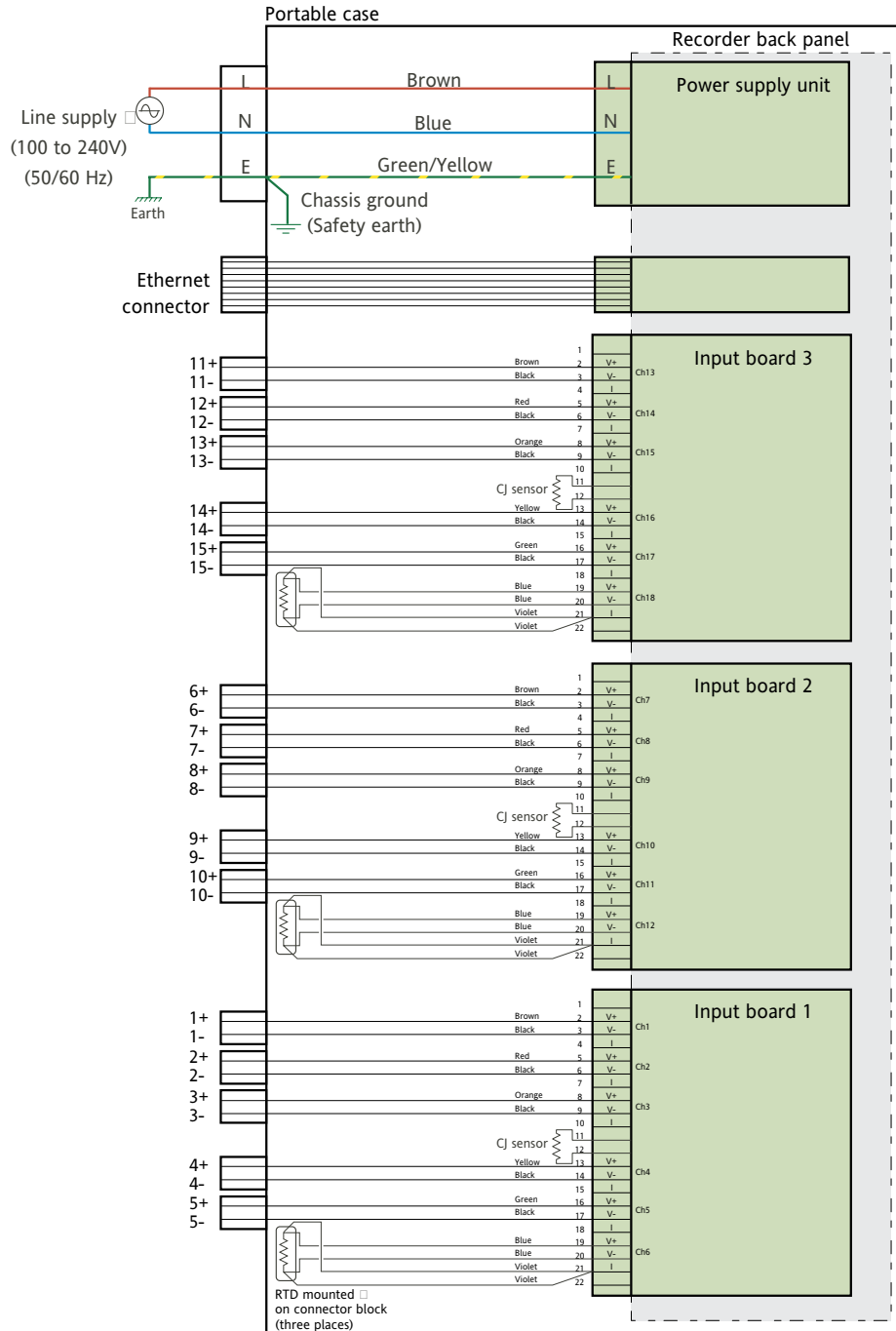

Figure 13.6.2c Internal wiring

13.6.3 Specification

Information additional to the general specification in Annex A.

Measurement accuracy (typical)	
Static at 25°C:	<±0.2°C error (after overall system calibration)
0 to 50°C:	<±0.3°C error (after overall system calibration)
Start-up time at ambient	2 minutes
Isolation	<30V RMS or <60Vdc

14 REMOTE CJ BLOCK OPTION

14.1 LARGE FRAME RECORDER WITH INTEGRAL CJC BLOCK

14.1.1 Introduction

This option allows up to 30 thermocouples of any type(s) to be connected to the recorder using miniature compensating connectors mounted on the rear terminal cover. Thermocouples may be connected directly, or using extension compensating cable.

Each row of five sockets has an associated aluminium bar, to which is bonded a resistance temperature detector (RTD) which acts as a cold junctions sensor, connected to the sixth channel of the relevant input board. For this reason, connector numbers 6 to 30 do not match the input channel numbering, but the recorder configuration names the channels in an unambiguous way, to reduce confusion. Table 14.1.1 gives details.

Connector 1 - Channel 1	Connector 6 - Channel 7	Connector 11 - Channel 13
Connector 2 - Channel 2	Connector 7 - Channel 8	Connector 12 - Channel 14
Connector 3 - Channel 3	Connector 8 - Channel 9	Connector 13 - Channel 15
Connector 4 - Channel 4	Connector 9 - Channel 10	Connector 14 - Channel 16
Connector 5 - Channel 5	Connector 10 - Channel 11	Connector 15 - Channel 17
Connector 16 - Channel 19	Connector 21 - Channel 25	Connector 26 - Channel 31
Connector 17 - Channel 20	Connector 22 - Channel 26	Connector 27 - Channel 32
Connector 18 - Channel 21	Connector 23 - Channel 27	Connector 28 - Channel 33
Connector 19 - Channel 22	Connector 24 - Channel 28	Connector 29 - Channel 33
Connector 20 - Channel 23	Connector 25 - Channel 29	Connector 30 - Channel 35

Table 14.1.1 Connector/channel cross reference

14.1.2 Wiring

SIGNAL WIRING

Caution

Thermocouples must not be attached to voltages greater than 24V,

Signal wiring consists of connecting the transducer wires into the correct type of plug (figure 14.1.2a) and inserting the plugs into the relevant sockets at the rear of the recorder.

Figure 14.1.2b shows the arrangement of the connectors at the rear panel, and Figure 14.1.2c shows the wiring between the portable case rear panel and the recorder.

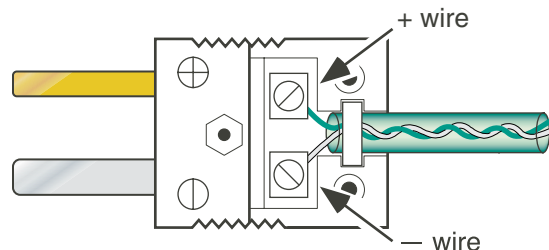

Figure 14.1.2a Connector detail (typical)

14 1.2 WIRING (Cont.)

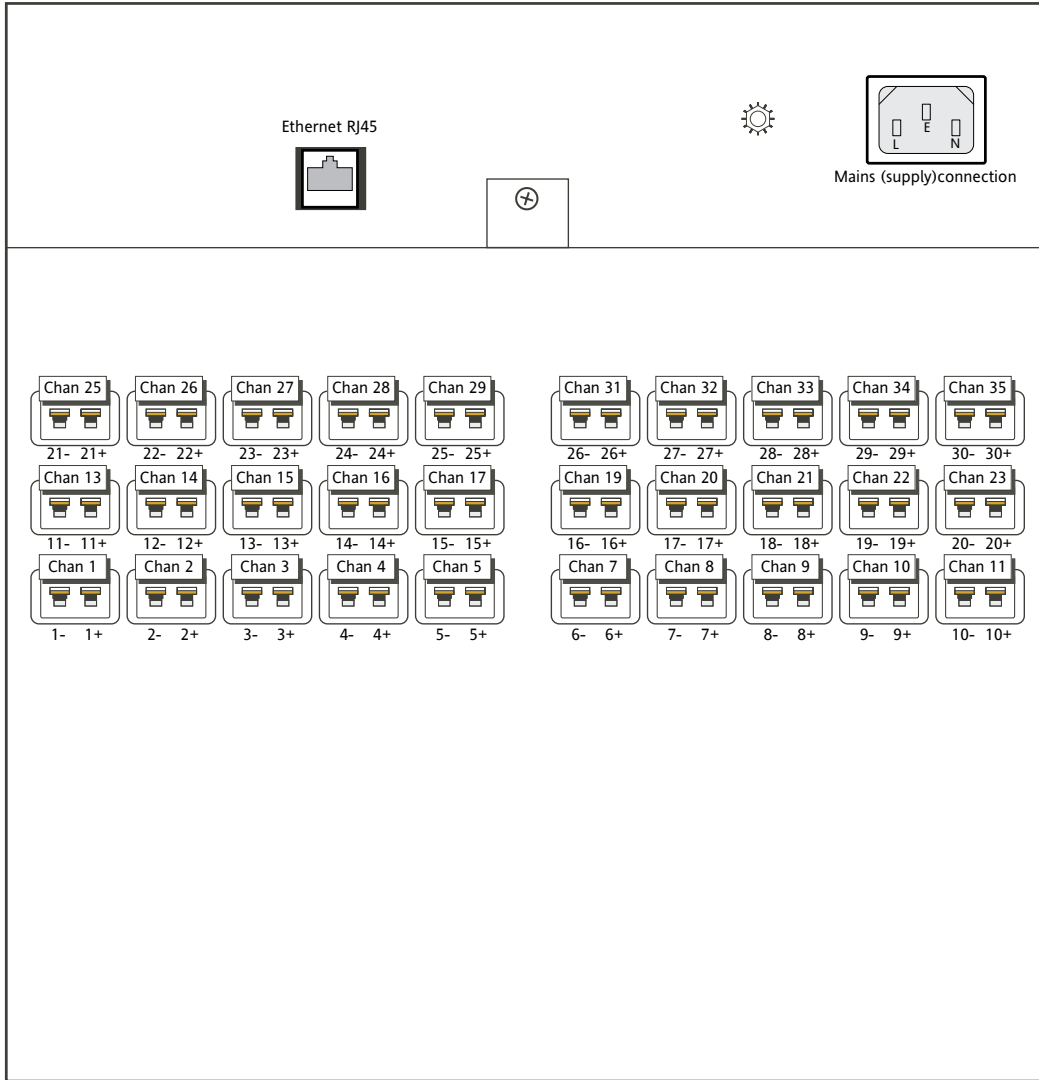

Figure 14.1.2b Rear panel connector layout

14 1.2 WIRING (Cont.)

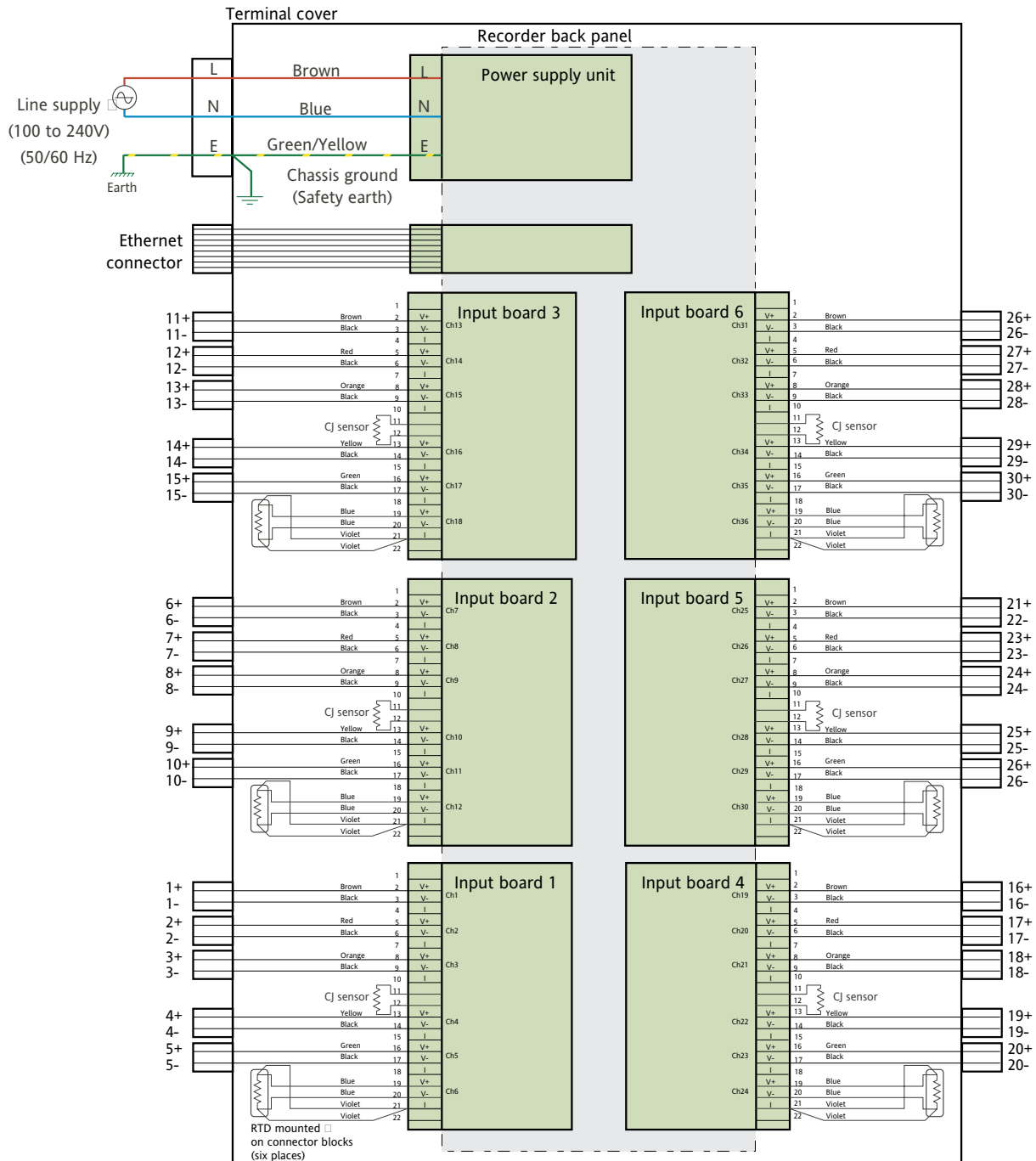

Figure 14.1.2c Internal wiring

14.1.3 Specification

Information additional to the general specification in Annex A.

Measurement accuracy (typical)

- Static at 25°C: $\leq \pm 0.2^\circ\text{C}$ error (after overall system calibration)
- 0 to 50°C: $\leq \pm 0.3^\circ\text{C}$ error (after overall system calibration)

Start-up time at ambient 2 minutes

Isolation <math>< 30\text{V RMS}</math> or <math>< 60\text{Vdc}</math>

14.2 LARGE FRAME RECORDER WITH REMOTE CJC BLOCK

14.2.1 Introduction

This option uses two Remote CJC Block units to allow up to 30 thermocouples of any type(s) to be connected to the recorder using miniature compensating connectors at a DIN rail mounted Remote CJ connector unit, with copper wire connections from this unit to the recorder input boards.. Thermocouples may be connected to the Remote CJ unit directly, or by using extension compensating cable.

Each row of five sockets has an associated aluminium bar, to which is bonded a resistance temperature detector (RTD) which acts as a cold junctions sensor, connected to the sixth channel of each of the six input boards.

Most connector numbers do not match the input channel numbering, but the recorder configuration names the channels in an unambiguous way, to reduce confusion. Table 14.2.1 gives details.

Note: Both of the Remote CJC Block units have connectors numbered 1 to 15, so it is important that the units be identified clearly as, for example' the 'input boards 1 to 3' unit and the 'input boards 4 to 6' unit in order to reduce the possibility of wiring errors.

Connector 1 - Channel 1	Connector 6 - Channel 7	Connector 11 - Channel 13	Input boards 1 to 3
Connector 2 - Channel 2	Connector 7 - Channel 8	Connector 12 - Channel 14	
Connector 3 - Channel 3	Connector 8 - Channel 9	Connector 13 - Channel 15	
Connector 4 - Channel 4	Connector 9 - Channel 10	Connector 14 - Channel 16	
Connector 5 - Channel 5	Connector 10 - Channel 11	Connector 15 - Channel 17	
Connector 1 - Channel 19	Connector 6 - Channel 25	Connector 11 - Channel 31	Input boards 4 to 6
Connector 2 - Channel 20	Connector 7 - Channel 26	Connector 12 - Channel 32	
Connector 3 - Channel 21	Connector 8 - Channel 27	Connector 13 - Channel 33	
Connector 4 - Channel 22	Connector 9 - Channel 28	Connector 14 - Channel 33	
Connector 5 - Channel 23	Connector 10 - Channel 29	Connector 15 - Channel 35	

Table 14.2.1 Connector/channel cross reference

14.2.2 Signal wiring

Caution

Thermocouples must not be attached to voltages greater than 24V,

SIGNAL WIRING

Signal wiring consists of

1. connecting the transducer wires into the correct type of plug (figure 14.2.2a), and inserting the plugs into the relevant sockets in the remote CJ unit.
2. Connecting the Remote CJ unit to the recorder input board terminals..

Figure 14.2.2b shows the arrangement of the connectors at the Remote CJ Block units; Figure 14.2.2c shows the recorder connector layout and figure 14.2.2d shows the wiring between the remote CJ unit and the recorder.

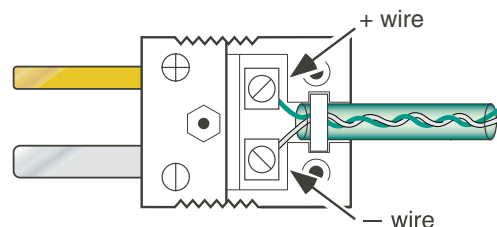
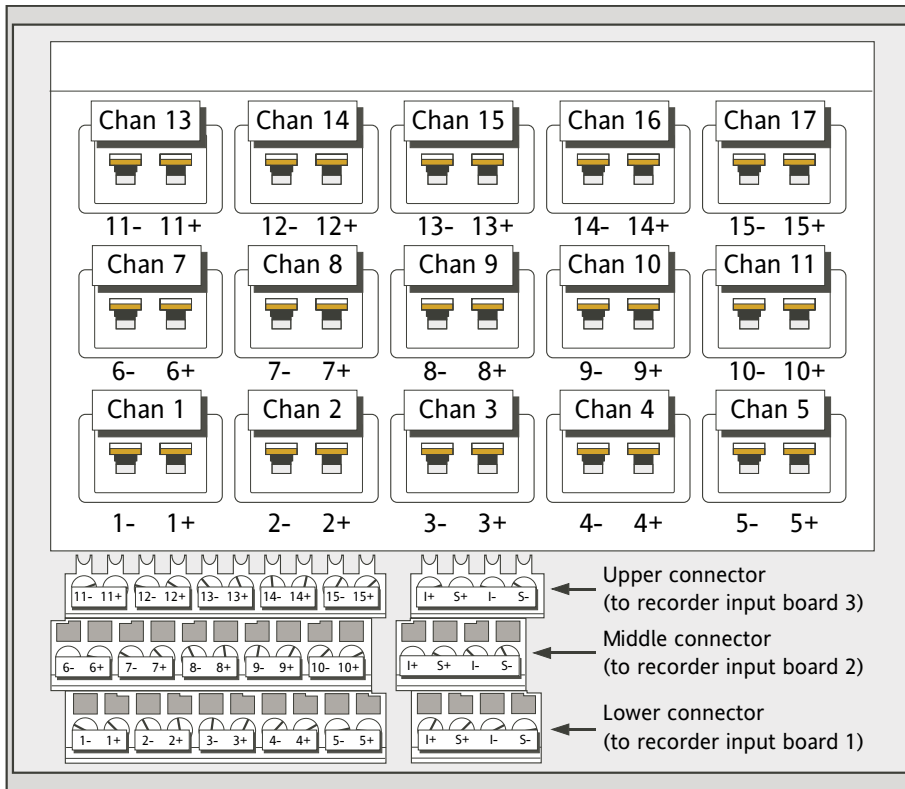

Figure 14.2.2a Connector detail (typical)

14.2.2 SIGNAL WIRING (Cont.)

Note: For the sake of clarity, the units in the figure below are shown one above the other. Normally they would be mounted side by side.



Input boards
1 to 3

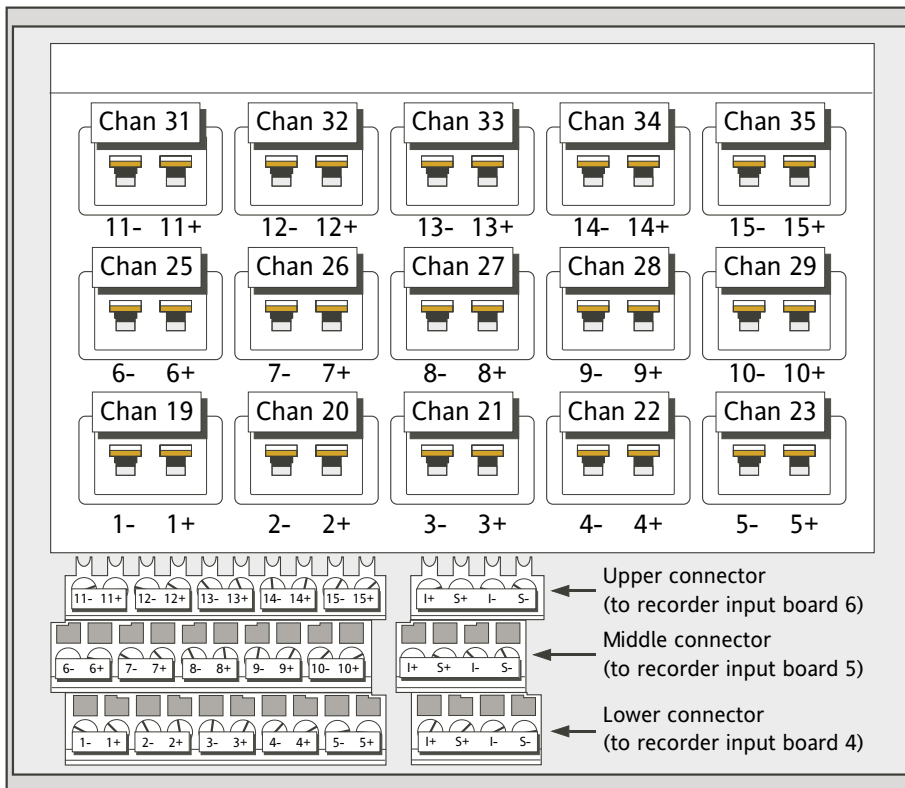

Input boards
4 to 6

Figure 14.2.2b Connector locations (Remote CJC Block units).

14.2.2 SIGNAL WIRING (Cont.)

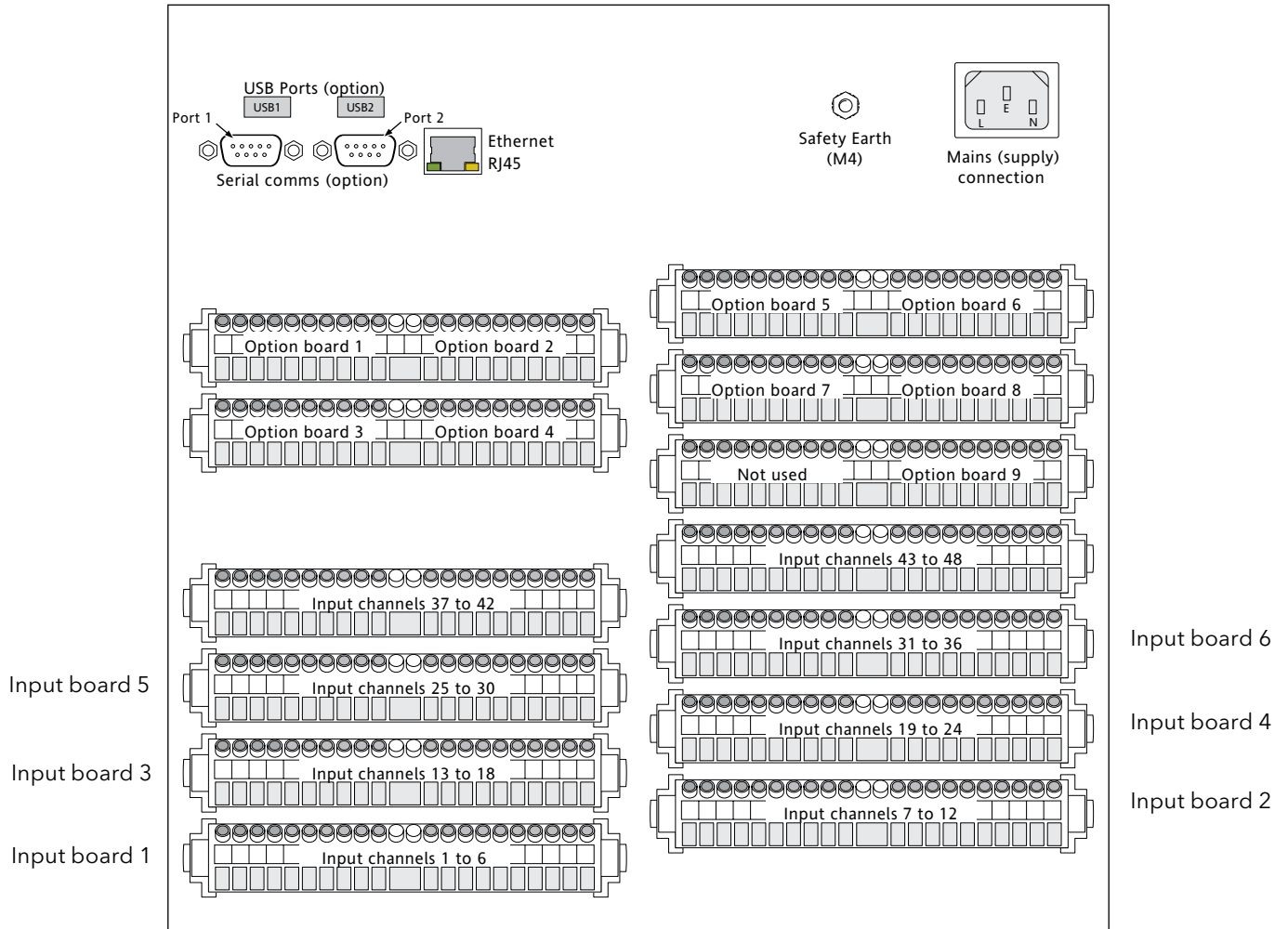

Figure 14.2.2c Connector locations (recorder)

14.2.2 SIGNAL WIRING (Cont.)

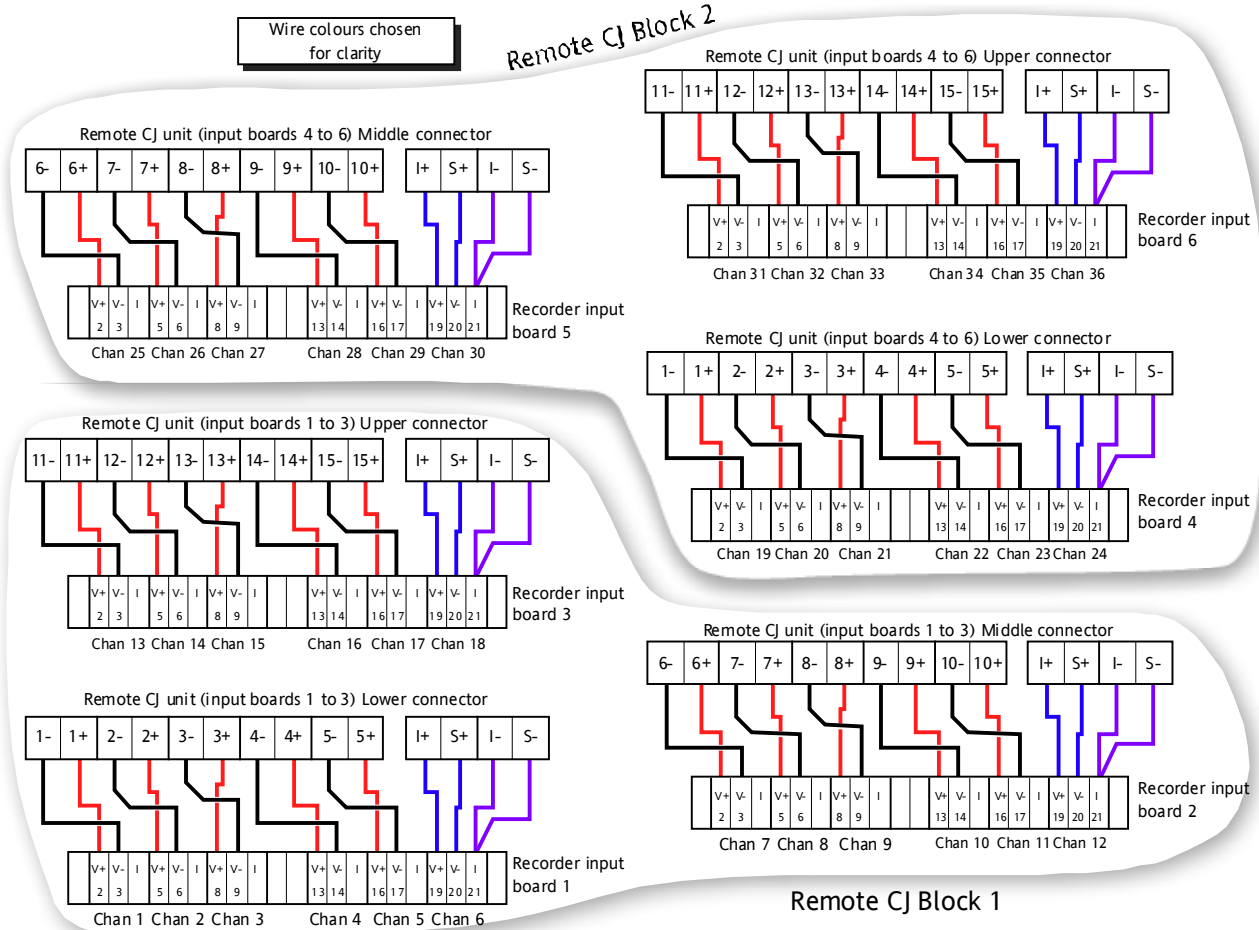

Figure 14.2.2c Wiring details

14.2.3 Specification

Information additional to the general specification in Annex A.

Measurement accuracy (typical)

- Static at 25°C: $\leq \pm 0.2^\circ\text{C}$ error (after overall system calibration)
- 0 to 50°C: $\leq \pm 0.3^\circ\text{C}$ error (after overall system calibration)

Start-up time at ambient

2 minutes

Isolation

$< 30\text{V RMS}$ or $< 60\text{Vdc}$

Dimensions

145 mm wide x 127.5 mm high x 75.6 mm deep (excluding DIN rail)

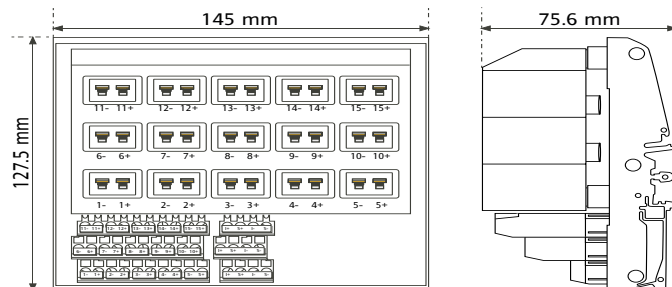

14.3 SMALL FRAME RECORDER

14.3.1 Introduction

This option allows up to 15 thermocouples of any type(s) to be connected to the recorder using miniature compensating connectors at a DIN rail mounted Remote CJ connector unit, with copper wire connections from this unit to the recorder input boards.. Thermocouples may be connected to the Remote CJ unit directly, or by using extension compensating cable.

Each row of five sockets has an associated aluminium bar, to which is bonded a resistance temperature detector (RTD) which acts as a cold junctions sensor, connected to the sixth channel of each of the three input boards. For this reason, connector numbers 6 to 15 do not match the input channel numbering, but the recorder configuration names the channels in an unambiguous way, to reduce confusion. Table 14.3.1 gives details.

Connector 1 - Channel 1	Connector 6 - Channel 7	Connector 11 - Channel 13
Connector 2 - Channel 2	Connector 7 - Channel 8	Connector 12 - Channel 14
Connector 3 - Channel 3	Connector 8 - Channel 9	Connector 13 - Channel 15
Connector 4 - Channel 4	Connector 9 - Channel 10	Connector 14 - Channel 16
Connector 5 - Channel 5	Connector 10 - Channel 11	Connector 15 - Channel 17

Table 14.3.1 Connector/channel cross reference

14.3.2 Signal wiring

Caution

Thermocouples must not be attached to voltages greater than 24V,

SIGNAL WIRING

Signal wiring consists of

1. connecting the transducer wires into the correct type of plug (figure 14.3.2a), and inserting the plugs into the relevant sockets in the remote CJ unit.
2. Connecting the Remote CJ unit to the recorder input board terminals..

Figure 14.3.2b shows the arrangement of the connectors at the remote CJ unit, and the recorder; figure 14.3.2c shows the wiring between the remote CJ unit and the recorder.

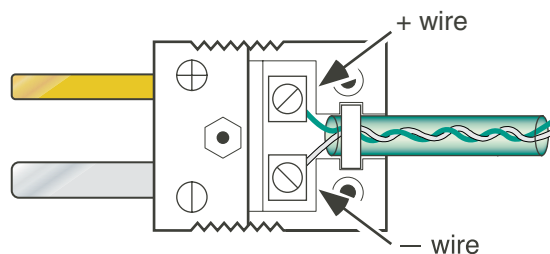
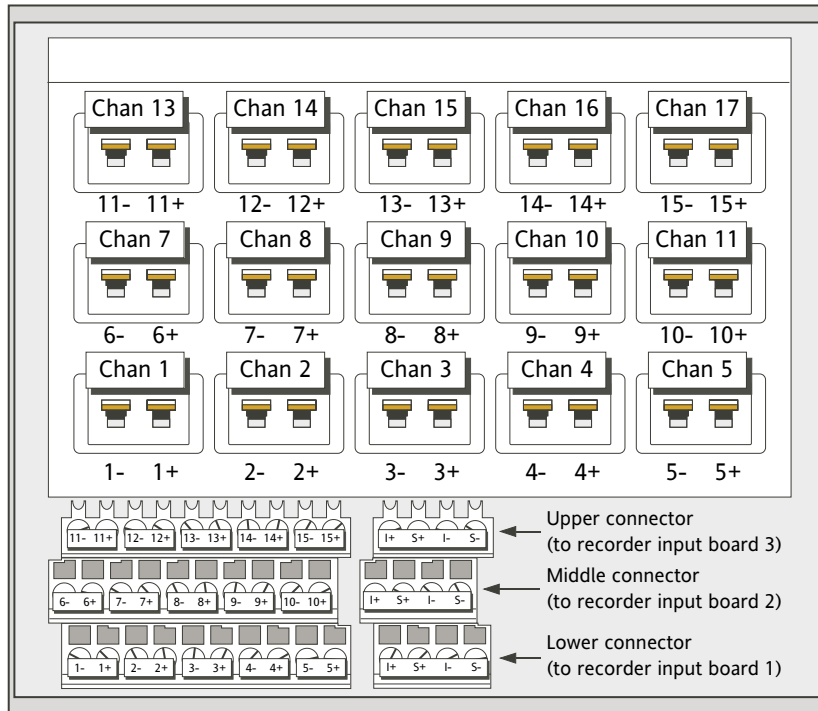
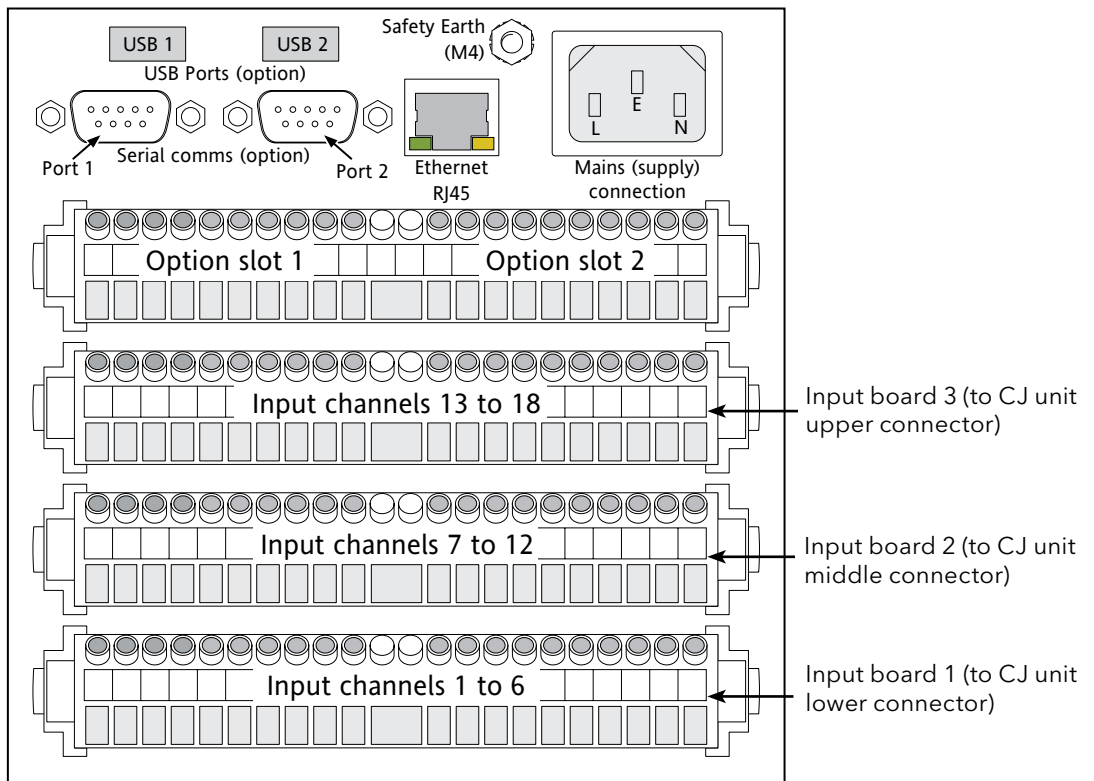

Figure 14.2.2a Connector detail (typical)

14.3.2 SIGNAL WIRING (Cont.)



a. Remote CJ unit



b. Recorder

Figure 14.3.2b Connector locations

14.3.2 SIGNAL WIRING (Cont.)

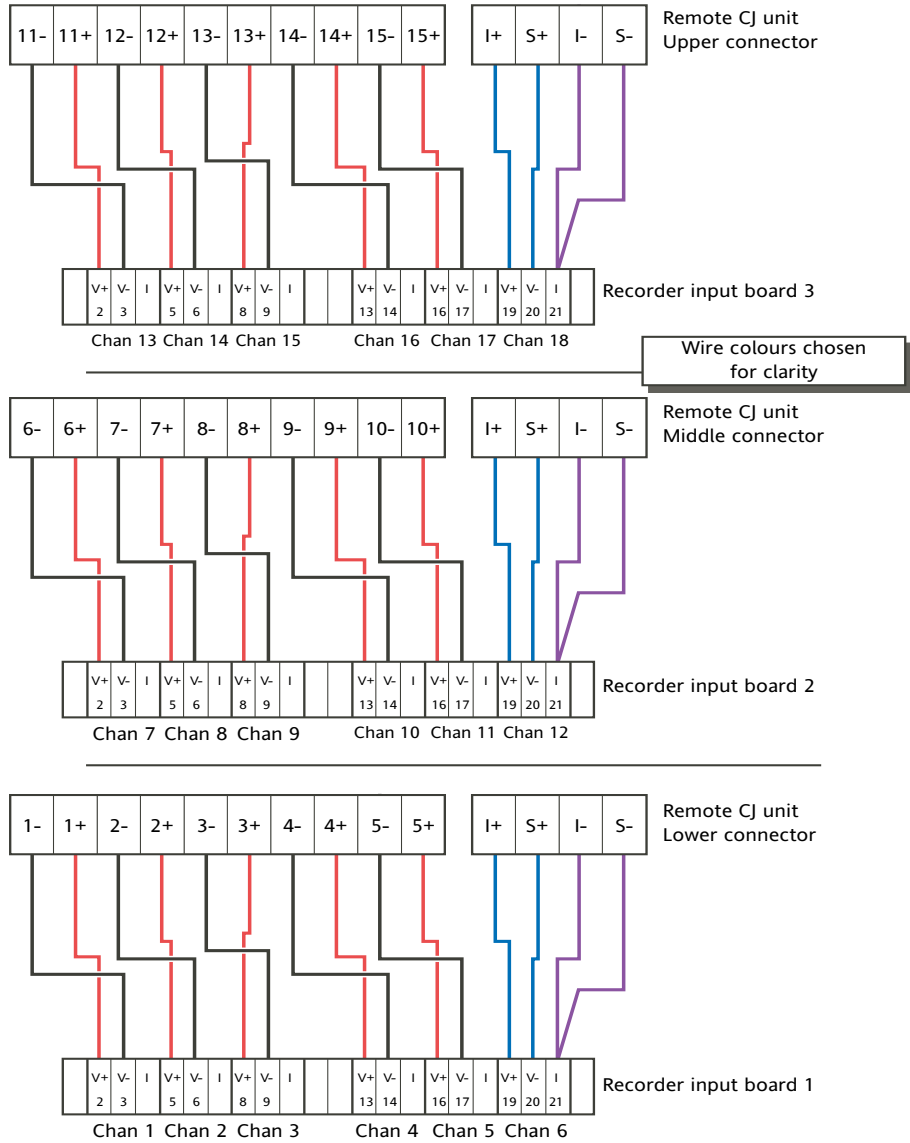

Figure 14.3.2c Wiring details

14.3.3 Specification

Information additional to the general specification in Annex A.

Measurement accuracy (typical)

- Static at 25°C: $\leq \pm 0.2^\circ\text{C}$ error (after overall system calibration)
- 0 to 50°C: $\leq \pm 0.3^\circ\text{C}$ error (after overall system calibration)

Start-up time at ambient

2 minutes

Isolation

<math>< 30\text{V RMS}</math> or <math>< 60\text{Vdc}</math>

Dimensions

145 mm wide x 127.5 mm high x 75.6 mm deep (excluding DIN rail)

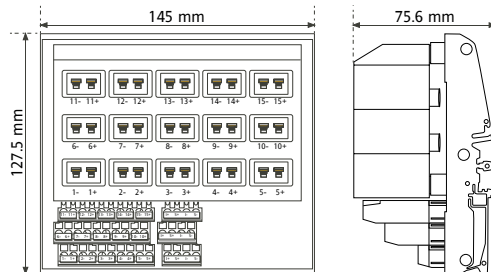

15 THERMAL UNIFORMITY SURVEY (TUS) OPTION

This option affects the way in which operator batch initiation occurs. [Section 4.3.10](#) contains a full description of batch recording and the user should refer to that section for details not contained here. The option also incorporates the 'Remote CJ block' option, so channels 6, 12, 18 and so on are 'reference' channels used to measure the block temperature.

15.1 PRE CALIBRATION AND POST CALIBRATION ENABLE

If the TUS option is fitted, two extra 'tick boxes' ('Pre calibration' and 'Post calibration') appear in the Batch configuration menu (figure 15.1).

The screenshot shows the 'Batch configuration menu' with the following settings:

- Scope: Group
- Group: 1) Group 1
- Show Batch Entry List:
- Enable:
- Batch mode: Start/Stop
- Batch Fields: 1
- Field 1: Batch Number:
- Batch field 1: Use Text
- On start log: 1
- On stop log: 1
- On new clear: 1
- Name files by batch:
- Pre calibration:
- Post calibration:

At the bottom are 'Apply' and 'Discard' buttons. A bracket groups the 'Pre calibration' and 'Post calibration' options, with an arrow pointing to the right towards the text in the adjacent column.

Figure 15.1 Batch configuration menu

Pre calibration

If this tick box is enabled, the operator is required to carry out an input adjust procedure before the batch can be initiated.

Post calibration

If this tick box is enabled, the operator is required to carry out an input adjust procedure when the batch is stopped.

15.2 INPUT ADJUST

Notes

1. Input adjust cannot be applied to input channels with input type of 'Digital', 'Test' or 'comms'.
2. Input adjustments can be carried out only by users with 'Adjust I/O' permission (see section 4.4.1).
3. The instrument must be powered for a sufficient time (e.g. 30 mins) for it to reach thermal equilibrium before an input adjust is performed.
4. The highest numbered channel on each input board (i.e. input channels 6, 12, 18 etc.) are reference channels and cannot be adjusted

This facility allows the user to compensate for tolerance errors etc. The technique used is to select those channels to which adjust is to be applied, then for each channel to:

- a. apply a known low level signal (at or close to the low input range value) to the relevant input. When the recorder reading is steady, press 'Apply'.
- b. apply a known high level signal (at, or close to, the high input range value) to the relevant input. When the recorder reading is steady, press 'Apply'.

Figure 15.2a shows the initial display. Channels 1 to 6 are selected by default.

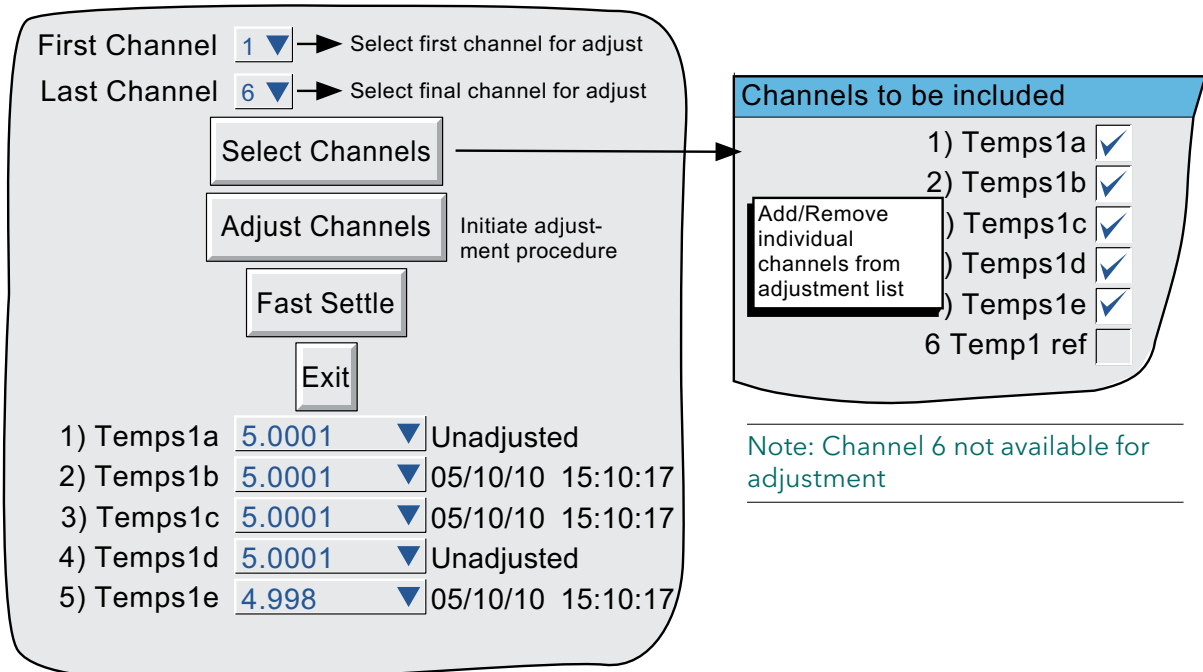

Figure 15.2a Input adjust status page

First channel	Allows the user to select the lowest channel number of all the channels to be adjusted.
Last channel	Allows the user to select the highest channel number of all the channels to be adjusted.
Select Channels	Presents a list of all the channels from the First channel to the Last channel inclusive, each of which can be removed from the adjustment list by 'unticking' its check box. The channels displayed in the status page reflect this selection.
Adjust channels	Initiates the adjustment procedure to all the channels from the First channel to the Last channel inclusive, unless the list has been modified using the 'Select Channels' key.
Fast Settle	Switches off the input filter for 1 second, to allow quicker response. Adjust Channels' values displayed as 'RANGING' for the 1 second duration.
Exit	Quits the current page. Must be operated after adjustment is complete, in order to continue batch initiation.
1) Temps1a etc.	A list of channels required to be susceptible to the adjustment procedure, together with their current values and their adjustment status (i.e. Unadjusted or, the time/date of the previous adjustment (if any)).

15.2 INPUT ADJUST (Cont.)

ADJUST PROCEDURE

Note: Adjusting a channel invalidates the accuracy values given in the specification in Annex A for that channel.

Operation of the Adjust Channels key calls the low-end adjust page, as shown in figure 15.2b.

Fast settle

Specify the sensor low point and connect the corresponding input.

Low Point

When the values below have settled select Apply.

1) Temps1a	<input type="text" value="-0.0026"/>	Unadjusted
2) Temps1b	<input type="text" value="-0.0001"/>	05/10/10 15:10:17
3) Temps1c	<input type="text" value="-0.0002"/>	05/10/10 15:10:17
4) Temps1d	<input type="text" value="-0.0002"/>	Unadjusted
5) Temps1e	<input type="text" value="0.0000"/>	05/10/10 15:10:17

Discard **Apply**

Figure 15.2b Typical low-end input adjust page

Fast Settle

Reduces the time taken for the readings to stabilise.

Low Point

Usually 0, but a different value can be entered here, if required.

Apply the Low point value to the relevant input channels, and wait for the recorder readings to become stable. When the readings are stable, press the Apply key, to call the High-end page depicted in figure 15.2c, below.

Fast settle

Specify the sensor low point and connect the corresponding input.

High Point

When the values below have settled select Apply.

1) Temps1a	<input type="text" value="4.9993"/>	Unadjusted
2) Temps1b	<input type="text" value="4.9972"/>	05/10/10 15:10:17
3) Temps1c	<input type="text" value="5.0010"/>	05/10/10 15:10:17
4) Temps1d	<input type="text" value="4.9994"/>	Unadjusted
5) Temps1e	<input type="text" value="5.010"/>	05/10/10 15:10:17

Discard **Apply**

Figure 15.2c Typical high-end input adjust page

Fast Settle

Reduces the time taken for the readings to stabilise.

High Point

Default value displayed, but a different value can be entered here, if required.

Apply the High point value to the relevant input channels, and wait some minutes for the recorder readings to become stable. When the readings are stable, press the Apply key, to return to the status page, then press 'Exit'. If this is a Pre calibration check, the Batch initiation continues as described in [section 4.6.10](#).

15.3 CHART MESSAGES

If Audit Trail is enabled then a number of messages appear on the chart, and included in the history file as described in section 4.4.2. If the TUS option is enabled, 'Pre calibration' and/or 'Post calibration' tick boxes are ticked, then further messages are produced for each adjusted channel, showing the pre calibration and post calibration high and low values.

Example:

```
05/10/10 16:20:57 5) Tempsle Pre cal high 5.010 Post cal high 5.000
05/10/10 16:20:57 4) Tempsld Pre cal high 4.994 Post cal high 5.000
05/10/10 16:20:57 3) Tempslc Pre cal high 5.001 Post cal high 5.000
05/10/10 16:20:57 2) Tempslb Pre cal high 4.997 Post cal high 5.000
05/10/10 16:20:57 1) Tempsla Pre cal high 4.993 Post cal high 5.000
05/10/10 16:20:57 5) Tempsle Pre cal low 0.000 Post cal low 0.000
05/10/10 16:20:57 4) Tempsle Pre cal low -0.002 Post cal low 0.000
05/10/10 16:20:57 3) Tempsle Pre cal low -0.002 Post cal low 0.000
05/10/10 16:20:57 2) Tempsle Pre cal low 0.001 Post cal low 0.000
05/10/10 16:20:57 1) Tempsle Pre cal low -0.003 Post cal low 0.000
```

15.4 OTHER ITEMS

Input channels 6, 12, 18 etc. are reference channels used to measure the temperature of the remote CJ block. They are therefore excluded from the adjust procedure and channel offsets ([section 4.3.3](#)) cannot be applied to them.

In 'Save and Restore', channel configuration will not be restored.

Batch initiation must be by operator action - job triggered batches do not support pre and post calibration.

ANNEX A: SPECIFICATION

INSTALLATION CATEGORY AND POLLUTION DEGREE

This product has been designed to conform to BS EN61010 installation category II and pollution degree 2. These are defined as follows:

Installation category II

The rated impulse voltage for equipment on nominal 230V ac mains is 2500V.

Pollution degree 2

Normally, only non-conductive pollution occurs. Occasionally, however, a temporary conductivity caused by condensation shall be expected.

TECHNICAL SPECIFICATION (Recorder)

Board types (I/O)

Universal input board
 Relay output boards (3 change-over, 4 normally closed or 4 normally open relays per board)
 6 - event input board
 Serial communications board
 2 - channel analogue output (retransmission) board

Standard features

Bridge 'Lite'
 Configuration Copy
 CSV Archive file format
 E-mail
 File transfer protocol (FTP) / Secure file transfer protocol (SFTP) or (S)FTP
 6 Groups
 Job search
 Log scales
 MODBUS TCP
 Messages
 Timers
 USB port behind access flap (not stainless-steel case option)
 Web server

Options

Software: ASCII Printer output (supplied as a part of the Serial Communications option)
 Audit trail
 21CFR11Audit
 Batch Recording
 Bridge 'Full' version
 EtherNet/IP Server (adapter)
 Event Buttons (supplied as a part of the Screen Builder option)
 Master Comms
 Maths/Totalisers/Counters
 Multiple groups (six additional groups)
 Screen Builder (User screens)
 Security Manager
 Simulation
 Thermal Uniformity Survey (TUS)

Hardware: Transmitter power supply - isolated (100 mm recorders only)
 Low supply voltage
 Access flap lock
 Stainless steel case (no access flap) (check availability)
 Further two USB ports at rear of recorder
 Serial Communications

Environmental Performance

Temperature limits	Operation: 0 to 50°C.
Storage:	- 20 to +60°C
Humidity limits	Operation: 5% to 80% RH non - condensing
Storage:	5% to 90% RH non - condensing
Altitude (maximum)	<2000 metres
Protection	Standard bezel/display: IP66 for a recorder mounted in a panel.
Standard sleeve:	IP20
Portable case option:	IP21
Stainless-steel case:	IP66 for a recorder mounted in a panel.
Shock	BS EN61010
Vibration (10 Hz to 150Hz)	2g peak

TECHNICAL SPECIFICATION (RECORDER) (Cont.)**Physical**

Panel mounting		DIN 43700
Bezel size	Small frame:	144mm x 144mm
	Large frame:	292mm x 292mm
Panel cutout	Small frame:	138mm x 138mm (-0.0 + 1.0) mm
	Large frame:	281mm x 281mm (-0.0 + 1.0) mm
Depth behind bezel	Small frame:	246.5 mm (211.5 mm without terminal cover, 284 with long terminal cover)
	Large frame:	260.90 mm (211 mm without terminal cover)
Weight	Small frame:	3 kg. max. (5 kg. max. if fitted in portable case)
	Large frame:	7 kg. max.
Mounting angle		±45° from vertical

Note: For portable case dimensions - see section 13.

Electromagnetic compatibility (EMC)

Emissions and immunity: BS EN61326

Electrical safety

BS EN61010. [Installation category II](#), [Pollution degree 2](#)

Power requirements

Supply voltage	Standard:	100 to 230 VAC (±15%); 47 to 63 Hz
	Low voltage option ¹⁾ :	20 to 42V RMS; 45 to 400 Hz, or 20 to 54V dc (option not to be used if isolated transmitter power supply fitted)
Power (max.)	All options:	60 W
Inrush current	Standard:	36A
	Low voltage option ¹⁾ :	36A
	Namur compliant option:	5.5A at 25°C
Fuse type		None
Interrupt protection	Standard:	Holdup >200msec. at 240V ac, with full load.
	Low voltage option ¹⁾ :	Holdup 20msec at 20Vdc or RMS, with full load.

Back-up battery

Type		Poly-carbonmonofluoride/lithium (BR2330). Part Number PA261095. See also section B2.2.
Support time		A fully-charged, new battery supports the Real-Time Clock for a minimum of 1 year with the recorder unpowered
Replacement period		3-years
Stored data		Time; date; values for totalisers, counters and timers; batch data; values for those maths functions with history, such as Fvalue, Rolling average, Stopwatch etc.

Clock (RTC) data

Temperature stability	0 to 50°C:	± 20 ppm
Ageing		±5 ppm per year

Touch screen

	Type:	Colour TFT LCD with cold-cathode backlighting, fitted with resistive, analogue, touch panel
Screen specification	Small frame:	1/4 VGA Resolution = 320 x 240 pixels
	Large frame:	XGA Resolution= 1024 x 768 pixels

Update information

Input/relay output sample rate:	8 Hz.
Display update:	8 Hz,
Archive sample value:	Latest value at archive time
Trended/displayed value:	Latest value at display update time

¹⁾ Option obsolete.

TECHNICAL SPECIFICATION (RECORDER) (Cont.)**Ethernet Communications**

Type		10/100 base T (IEEE802.3)
Protocols		TCP/IP, FTP(S)/FTP, DHCP, BootP, SNMP, Modbus, SMTP, ICMP.
Cable	Type:	CAT5
	Maximum length:	100 metres
	Termination:	RJ45
RJ45 LED indicators	Green:	Indicates a 100MB link
	Yellow:	Indicates Ethernet activity
Internal green LED		Indicates a 10MB link

Serial communications option

Number of ports	Two, at rear of instrument
Protocol	ASCII input, ASCII printer, Modbus master, Modbus slave.
Transmission standards	EIA232 and/or EIA485, software selectable per port. EIA485 can be connected as 3-wire or 5-wire as required.
Isolation (dc to 65Hz BS EN61010)	Installation category II; Pollution degree 2.
	Terminals to ground: 50 V RMS or dc (basic insulation)

Transmitter power supply (Isolated) (Small frame recorders only)

Number of outputs	Three
Output voltage	25V nominal
Max. current	20mA per output
Isolation (dc to 65Hz BS EN61010)	Installation category II; Pollution degree 2.
	Channel to channel: 100V RMS or dc (double insulation)
	Channel to ground: 100V RMS or dc (basic insulation).
Fuse (20mm Type T)	
	Supply voltage = 110/120Vac: 100 mA
	Supply voltage = 220/240Vac: 63 mA

USB ports

Number of ports	1 at front of recorder (standard*); 2 further ports (optional - at rear of instrument) (*No front USB port with Stainless steel case option)
Standard	USB1.1
Transmission speeds	12Mbits/sec (full speed devices) or 1.5Mbits/sec (low speed devices)
Maximum current per port	500mA
Peripherals supported	Floppy disk drive, Keyboard, Bar code reader, Mouse, Memory stick.

Note: The recorder meets the industrial EMC requirements of BS EN61326. Typically, USB peripherals are tested to domestic information technology standards (BS EN55022) with category C performance. Some USB peripherals, designed for use in domestic or office environments, can be susceptible to 'lock up' in environments containing high electromagnetic field strengths. In order to recover from such 'lock up' situations, the peripheral must be disconnected and then reconnected. Recorder operation is not affected.

Other items

Virus susceptibility	The 6000 series VxWorks operating system is immune to viruses targeted at Windows based operating systems. As at December 2005, there are no known viruses that target VxWorks.
Calibration coefficients	Input: The Read-only input coefficients are stored in EEPROM on the input board. Instrument: Instrument configuration is held in FLASH memory and has no effect on calibration coefficients.

TECHNICAL SPECIFICATION (Universal input board)

General*

Termination	Edge connector/terminal block
Max. number of inputs	Small frame: 18 (three 6-input boards) Large frame: 48 (eight 6-input boards)
Input ranges	±38mV; ±150mV; ±1V; ± 20 Volts
Input types	Dc volts, dc millivolts, dc milliamps, (with external shunt), thermocouple, 2/3 wire resistance temperature detector (RTD), Ohms, Contact closure (not channels 1, 7, 13,19, 25, 31, 37, 43) (Minimum contact closure = 60msec.)
Input type mix	Freely configurable
Sample rate	See 'Update information' above
Noise rejection (48 to 62Hz)	Common mode: >140dB (Channel to channel and channel to ground) Series mode: >60dB
Maximum common mode voltage	250Volts continuous
Maximum series mode voltage	45mV at lowest range; 23.74 Volts peak at highest range
Isolation (dc to 65Hz; BS EN61010)	Installation category II; Pollution degree 2 300V RMS or dc channel to channel (double insulation), channel to common electronics (double insulation) and channel to ground (basic insulation)
Dielectric strength	Channel to ground: 1500Vac for 1 minute. Channel to channel: 2500Vac for 1 minute
Insulation resistance	>10MΩ at 500V dc
Input impedance	20V range: 65.3kΩ Other ranges: >10MΩ
Overvoltage protection	50V peak (150V with attenuator)
Open circuit detection (applies only to ± 38mV and ± 150mV ranges).	Detection current: ± 57nA max Recognition time: 500mSec
	Minimum break resistance: 10MΩ
Long term drift (typical)	Better than 0.03% of reading or 30µV (whichever is greater) over a three month period.

For small frame recorders only:
For 6 input recorders, up to four option boards may be fitted.
For 12 input recorders up to four option boards may be fitted
For 18 channel recorders up to two option boards may be fitted.

DC input ranges

Shunt	Externally mounted resistor modules
Additional error due to shunt	0.1% of input
Performance	See table

Low Range	High Range	Resolution	Typical error (Instrument at 20 deg C)	Maximum error (Instrument at 20 deg C)	Worst case temperature performance
-38 mV	38 mV	1.4 µV	0.013% input + 0.031% range	0.030% input + 0.052% range	25ppm of input per deg C
-150 mV	150 mV	5.5 µV	0.013% input + 0.028% range	0.029% input + 0.039% range	25ppm of input per deg C
-1 V	1 V	37 µV	0.013% input + 0.024% range	0.029% input + 0.029% range	25ppm of input per deg C
-20 V	20 V	720 µV	0.075% input + 0.027% range	0.393% input + 0.033% range	388ppm of input per deg C

Note: The table above applies to recorders with status level E7 or above (June 2007). For instruments prior to this, see the table in 'Previous instruments' later in Annex A.

***WARNING**

For portable case instruments only:

All I/O connections must be Low Voltage (maximum 33V ac RMS, 46.7V ac peak or 70Vdc) unless the integrity of the instrument safety earth is maintained for as long as the I/O is connected to the recorder.

TECHNICAL SPECIFICATION (Universal input board) (Cont.)

Resistance inputs

Temperature scale	ITS90
Types, ranges and accuracies	See tables (values exclude influence of lead resistance)
Influence of lead resistance Error:	Negligible
Mismatch:	1Ω/Ω
Maximum source current	250μA

Low Range	High Range	Resolution	Typical error (Instrument at 20 deg. C)	Maximum error (Instrument at 20 deg. C)	Worst case temperature performance
0Ω	150Ω	5mΩ	0.027% input + 0.034% range	0.037% input + 0.077% range	30ppm of input per deg C
0Ω	600Ω	22mΩ	0.027% input + 0.035% range	0.037% input + 0.057% range	30ppm of input per deg C
0Ω	5kΩ	148mΩ	0.030% input + 0.034% range	0.040% input + 0.041% range	30ppm of input per deg C

Note: The table above applies to recorders with status level E7 or above (June 2007). For instruments prior to this, see the table in 'Previous instruments' later in Annex A.

RTD type	Overall range (°C)	Standard	Max. linearisation error
Cu10	-20 to + 400	General Electric Co.	0.02°C
Cu53	-70 to + 200	RC21-4-1966	< 0.01°C
JPT100	-220 to + 630	JIS C1604:1989	0.01°C
Ni100	-60 to + 250	DIN43760:1987	0.01°C
Ni120	-50 to + 170	DIN43760:1987	0.01°C
Pt100	-200 to + 850	IEC751	0.01°C
Pt100A	-200 to + 600	Eurotherm Recorders SA	0.09°C
Pt1000	-200 to + 850	IEC751	0.01°C

Thermocouple data

Temperature scale	ITS90
Bias current	0.05nA
Cold junction compensation types	Off, internal, external, remote
Remote CJC source:	Any input or maths channel.
Internal CJC error	1°C max with instrument at 25°C
Internal CJC rejection ratio	50:1 minimum
Upscale/downscale drive Types:	'High', 'low' or 'none' selectable for each thermocouple channel.
Additional error:	Typically 0.01°C - depends on wiring. (Detect current = 57nA.)
Types, ranges and accuracies	See table

T/C type	Overall range (°C)	Standard	Max. linearisation error
B	0 to + 1820	IEC584.1	0 to 400°C = 1.7°C 400 to 1820°C = 0.03°C
C	0 to + 2300	Hoskins	0.12°C
D	0 to + 2495	Hoskins	0.08°C
E	-270 to + 1000	IEC584.1	0.03°C
G2	0 to + 2315	Hoskins	0.07°C
J	-210 to + 1200	IEC584.1	0.02°C
K	-270 to + 1372	IEC584.1	0.04°C
L	-200 to + 900	DIN43710:1985 (To IPTS68)	0.02°C
N	-270 to + 1300	IEC584.1	0.04°C
R	-50 to + 1768	IEC584.1	0.04°C
S	-50 to + 1768	IEC584.1	0.04°C
T	-270 to + 400	IEC584.1	0.02°C
U	-200 to + 600	DIN43710:1985	0.08°C
NiMo/NiCo	-50 to + 1410	ASTM E1751-95	0.06°C
Platinel	0 to + 1370	Engelhard	0.02°C
Ni/NiMo	0 to + 1406	Ipsen	0.14°C
Pt20%Rh/Pt40%Rh	0 to + 1888	ASTM E1751-95	0.07°C

WORST CASE ERROR CALCULATION

Assuming type T thermocouple at 350°C, ambient temp = 40°C, CJC = internal.

Total error = input error + range error + temperature error + linearisation error + cold junction error.

Input error:

From thermocouple tables, a type T thermocouple generates a voltage of 17.819mV at 350 °C. From the dc performance table above, the maximum error is 0.030% input = $0.03 \times 17.819/100 = 5.346\mu\text{V}$

Range error:

The 38mV range is used as the type t thermocouple is defined to cover the range -270°C (-6.258mV) to +400°C (20.872mV). From the dc performance table, the maximum range error is 0.052% range, and the range is $38 + 38 = 76$ mV. Thus the maximum range error is $0.052 \times 76/100 = 39.52\mu\text{V}$.

Temperature error:

The dc performance table above is specified at 20°C, but the ambient in this example is 40°C. From the dc performance table, the worst case temperature performance is 25ppm/°C, so our error is $25 \times (40-20) \times 17.819 \times 10^{-6} = 8.910\mu\text{V}$.

Linearisation error:

From the thermocouple table, the maximum linearisation error for a type t thermocouple is 0.02 °C

Cold junction compensation (CJC) error:

The internal CJC error is 1°C maximum with the instrument at 25°C. The CJC rejection ratio is 50:1, so a further error of $(40-25)/50 = 0.30$ °C may occur, giving a total maximum CJC error of 1.3°C.

Maximum error

From the above, the total error adds up as follows:

Input error:	5.346μV
Range error:	39.520μV
Temperature error:	8.910μV
Linearisation error:	0.02°C
CJC error:	1.30 °C
Total error:	53.776μV + 1.32°C

From thermocouple tables, a change of 1°C is equivalent to a change of 60μV, so a change of 53.776μV is equivalent to a change of 0.896°C.

Thus the total worst case error for this example is $(0.896 + 1.32) = 2.216^\circ\text{C}$

PREVIOUS INSTRUMENTS

This section contains dc performance and resistance input data for instruments with status levels prior to D6 (June 2007).

DC input ranges

Shunt	Externally mounted resistor modules
Additional error due to shunt	0.1% of input
Performance	See table

Low Range	High Range	Resolution	Typical error (Instrument at 20 deg C)	Maximum error (Instrument at 20 deg C)	Worst case temperature performance
-38 mV	38 mV	1.4 μ V	0.035% input + 0.031% range	0.085% input + 0.052% range	80ppm of input per deg C
-150 mV	150 mV	5.5 μ V	0.035% input + 0.028% range	0.084% input + 0.039% range	80ppm of input per deg C
-1 V	1 V	37 μ V	0.035% input + 0.024% range	0.084% input + 0.029% range	80ppm of input per deg C
-20 V	20 V	720 μ V	0.097% input + 0.027% range	0.448% input + 0.033% range	443ppm of input per deg C

Note: The table above applies to recorders with status level prior to E7 (June 2007). For instruments with a status level of E7 or above, see the [equivalent table](#) earlier in Annex A.

*WARNING

For portable case instruments only:

All I/O connections must be Low Voltage (maximum 33V ac RMS, 46.7V ac peak or 70Vdc) unless the integrity of the instrument safety earth is maintained for as long as the I/O is connected to the recorder.

Resistance inputs

Temperature scale	ITS90
Types, ranges and accuracies	See tables (values exclude influence of lead resistance)
Influence of lead resistance	Error: Negligible
Mismatch:	1 Ω / Ω
Maximum source current	250 μ A

Low Range	High Range	Resolution	Typical error (Instrument at 20 deg. C)	Maximum error (Instrument at 20 deg. C)	Worst case temperature performance
0 Ω	150 Ω	5m Ω	0.027% input + 0.034% range	0.042% input + 0.110% range	35ppm of input per deg C
0 Ω	600 Ω	22m Ω	0.027% input + 0.035% range	0.042% input + 0.053% range	35ppm of input per deg C
0 Ω	6k Ω	148m Ω	0.030% input + 0.028% range	0.045% input + 0.035% range	35ppm of input per deg C

Note: The table above applies to recorders with status level prior to E7 (June 2007). For instruments with a status level of E7 or above, see the [equivalent table](#) earlier in Annex A.

RTD type	Overall range ($^{\circ}$ C)	Standard	Max. linearisation error
Cu10	-20 to + 400	General Electric Co.	0.02 $^{\circ}$ C
Cu53	-70 to + 200	RC21-4-1966	< 0.01 $^{\circ}$ C
JPT100	-220 to + 630	JIS C1604:1989	0.01 $^{\circ}$ C
Ni100	-60 to + 250	DIN43760:1987	0.01 $^{\circ}$ C
Ni120	-50 to + 170	DIN43760:1987	0.01 $^{\circ}$ C
Pt100	-200 to + 850	IEC751	0.01 $^{\circ}$ C
Pt100A	-200 to + 600	Eurotherm Recorders SA	0.09 $^{\circ}$ C
Pt1000	-200 to + 850	IEC751	0.01 $^{\circ}$ C

TECHNICAL SPECIFICATION (Relay output board)

General

Maximum number of relay boards	
Small-frame unit	Four
Large-frame unit	Nine
Number of relays per board	
Changeover relays:	Three
Normally open relays:	Four
Normally closed relays:	Four
Estimated mechanical life	30,000,000 operations
Update rate	See 'Update rates' in 'Recorder specification' above

AC load ratings

Derating

The figures given below are for resistive loads. For reactive or inductive loads, de-rate in accordance with graph 1, in which

- F1 = Actually measured results on representative samples
- F2 = Typical values (according to experience)
- Contact life = Resistive contact life x reduction factor.

Maximum switching power	500VA
Maximum contact voltage	250V providing this does not cause the maximum switching power (above) to be exceeded
Maximum contact current	2 Amps providing this does not cause the maximum switching power (above) to be exceeded

DC load ratings

Maximum switching power	See graph 2 for operating volt/Amp envelope
Maximum contact voltage/current	See graph 2 for examples.

Safety isolation

Isolation (dc to 65 Hz; BS EN61010)	Installation category II; Pollution degree 2
Relay to relay:	300V RMS or dc (double insulation)
Relay to ground:	300V RMS or dc (basic insulation)

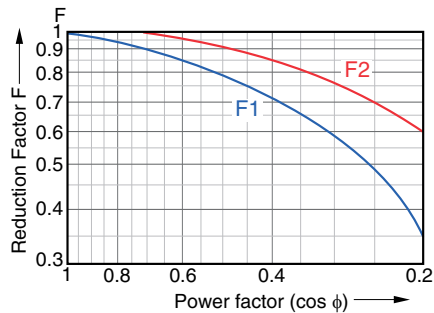

Graph 1 Derating curves for ac loads

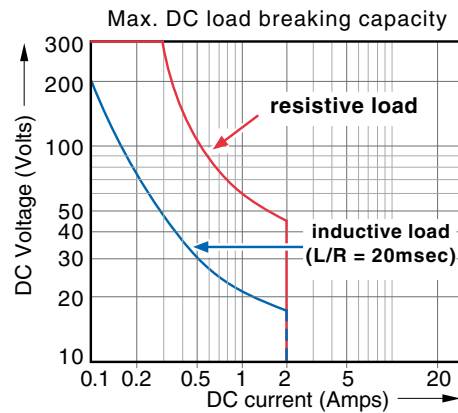

Graph 2 DC load switching curves

TECHNICAL SPECIFICATION (Event input board)**General**

Maximum number of event input boards	Four
Number of inputs per board	Six
Type of input	Contact closure (active closed) or voltage level (active low)
Recognition levels (input to 'C' terminal) (R = contact resistance)	
Active:	-30V to + 0.8V or switch contacts closed (R < 35kΩ).
Undefined:	+ 0.8V to + 2.0V (35 kΩ < R < 200kΩ)
Inactive:	+ 2V to +30V or switch contacts open (R > 200kΩ).
Maximum frequency	8 Hz
Minimum closure or pulse width	62.5 msec
Current sink for voltage inputs	10mA max

Isolation

Event input to ground:	50V RMS or dc (double insulation)
Event input to Event input:	0V

TECHNICAL SPECIFICATION (Analogue output board)**General**

Max number of analogue o/p boards	Four
Number of outputs per board	Two
Output ranges	Voltage: 0 to 10V (source 5mA max.) Current: 0 to 20 mA
Update rate	See 'Update rates' in 'Recorder specification' above
Step response	250msec (10% to 90%)
Linearity	0.024% of hardware range
Performance	See table

Performance in instrument at 20 deg. C		
Range	Accuracy	Temperature drift
0 to 10 V	0.1% of range	-0.12mV +0.022% of reading per deg. C
0 to 20 mA	0.1% of range	- 1µA + 0.03% of reading per deg. C

Safety isolation

Isolation (dc to 65 Hz; BS EN61010)	Installation category II ; Pollution degree 2
Output channel-to output channel:	300V RMS or dc (double insulation)
Output channel to ground:	300V RMS or dc (basic insulation)

TECHNICAL SPECIFICATION (ASCII Printer)

See the documentation supplied with the printer

ANNEX B: REFERENCE

B1 DIAGNOSTICS DISPLAY

B1.1 MAIN DIAGNOSTIC DISPLAY

At power-up, continuously hold a finger in contact with the screen until the main diagnostic display appears as shown in figure B1.1

Special Modes	Display Test
Touch Calibration	System Summary
Diag Summary	Quit

Figure B1.1 Top-level diagnostic display

B1.2 SPECIAL MODES

For factory use only, selecting 'Special Modes' allows the enabling and disabling of the Sales Demo mode of operation.



An 'S' symbol is displayed at the top of the screen whilst the recorder is in sales demo mode.

B1.3 DISPLAY TEST

Selecting this option, allows the user to check the display by flooding the screen with single colours. Repeatedly touching the screen, scrolls through the following colour sequence: Black, White, Red, Green, Blue, Cyan, Magenta, Yellow. A further operation of the touch screen returns the main diagnostic screen.

B1.4 TOUCH CALIBRATION

Touching this key calls a selection screen as shown below:

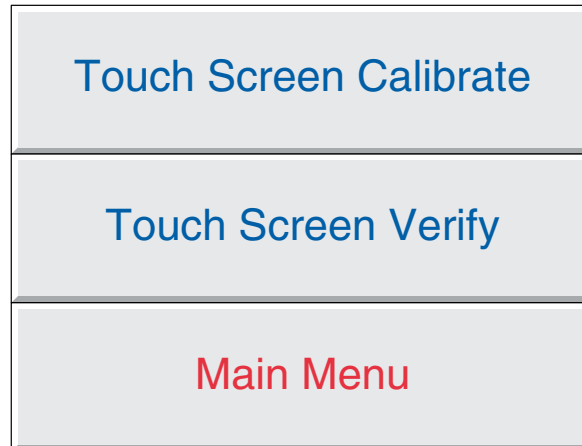

Figure B1.4 Touch screen selections

B1.4.1 Touch screen calibrate

This key initiates the display calibration (offset correction) procedure. This procedure ensures that the display screen image is positioned correctly compared with the touch screen (so that 'what you touch is what you get'). The procedure, is necessary only rarely, if at all, and is included here only for the sake of completeness.

1. Operate the 'Touch Screen Calibrate' key to call the first calibration screen, as depicted in figure B1.4.1
2. Using the stylus, touch the intersection of the upper set of crosshairs, as requested by the display and keep touching it until the next target appears.
3. Continue the process, according to the directions appearing on the screen. Once all the 'targets' have been accepted, the recorder returns to the diagnostic display.



Figure B1.4.1 Initial calibration display

B1.4.2 Touch screen verify

This allows the user to check the accuracy of the touch screen without having to carry out the calibration procedure described above.

Touching the screen with the stylus produces a crosshair at the position the recorder believes the screen to have been touched. It is up to the user to decide if the response is good enough for recorder operation. After a few seconds of non-operation, the recorder returns to the top level touch screen display (figure 1.4).

B1.4.3 Main menu

Touching this returns the user to the top level diagnostics screen ([Figure B1.1](#))

B1.5 SYSTEM SUMMARY

This key calls a system summary display, as shown for a typical small-frame recorder, in figure B1.5.

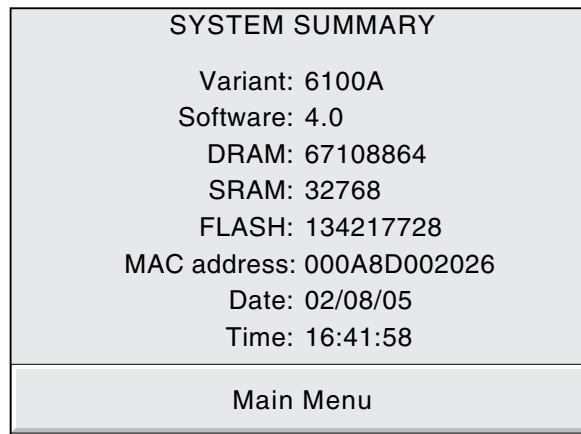

Figure B1.5 System summary display

B1.6 DIAG SUMMARY

Note: The diagnostic display does not include details of the Transmitter Power Supply option (if fitted).

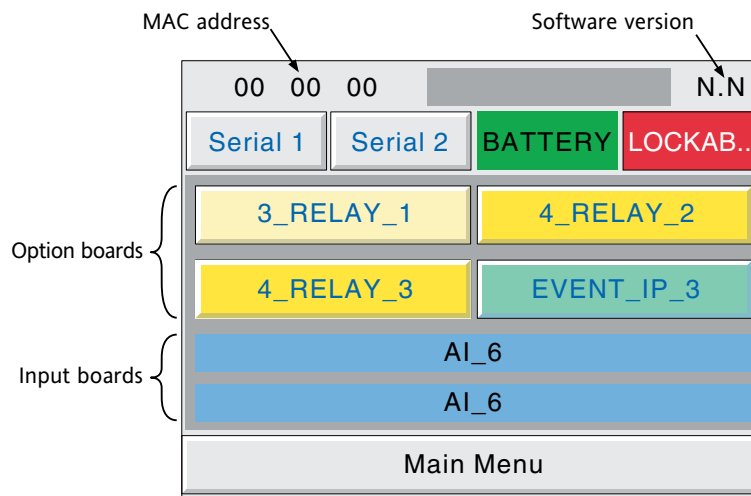

Figure B1.6 Diag Summary (small frame recorder - large frame similar)

B1.6.1 MAC Address

Each instrument is allocated a unique hex address as a part of the manufacturing process. The display at the top left of the display screen shows the final 6 characters of this address. The full address can be found in the System Summary display, described above, or in the Network\Name display described in section 4.5.1.

B1.6.2 Software version number

This shows the version number of the software fitted to the recorder.

B1.6.3 Serial 1/Serial 2

Touching one of these keys performs a loopback test on the relevant Serial port. In order for the test to be successful, a 9-way D-type socket, wired as in figure B1.6.3, must be fitted to the relevant serial port at the rear of the recorder. If wired as shown, the socket is suitable for testing with both EIA232 and EIA485 communications standards. The test will result in the legend 'S1(2) Passed' or 'S1(2) Failed' replacing 'Serial 1' or 'Serial 2' on the appropriate key. If the Serial Comms option is not fitted, pressing either key returns a 'Failed' message.

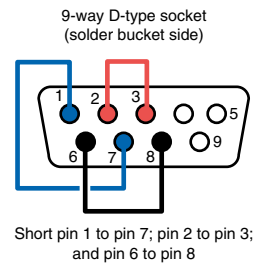

Figure B1.6.3 Loop back test wiring

B1.6.4 Battery

This area, normally green, flashes red/white when the battery needs to be replaced (section B2). Battery status is checked once every 15 minutes.

B1.6.5 Lockable

The lockable flap display is green if the lockable flap is fitted, or flashes red/white if the option is not fitted.

B1.6.6 Option boards

This shows which option boards are fitted where as viewed from the rear of the recorder.

RELAY OUTPUT BOARDS

If relay output boards are fitted, the associated relays can be tested, by touching the Option board key, then touching the relevant relay key to energise/de-energise the relay. Figure B1.6.6 shows a typical display.

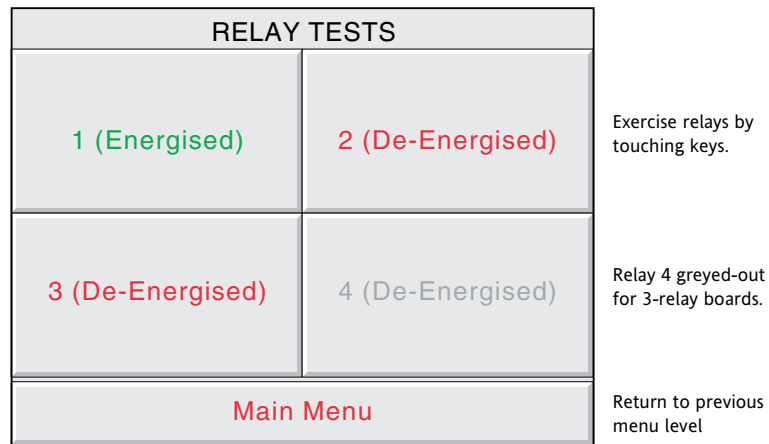

Figure B1.6.6 Relay board test display

EVENT INPUTS

If event input boards are fitted, touching the option board key calls a display showing input status (1 = active; 0 = not active). Changes in input status can be displayed by operating the 'Update' key.

B1.6.7 Input boards

This shows how many input boards are fitted.

B1.6.8 Main menu

To return to the main diagnostics display, touch the 'Main Menu' key.

B1.7 QUIT

Allows the user to quit diagnostics (after confirmation). The recorder restarts in normal operating mode.

B2 PREVENTIVE MAINTENANCE

B2.1 TOUCH SCREEN CLEANING

CAUTION

The touch-sensitive screen used in this product is designed for use by hand or by the stylus supplied only. The use of sharp or pointed implements such as pens, keys and fingernails to operate the instrument must be avoided, or irreparable damage will be done to the surface material. When cleaning the touch-screen, a moist cloth should be used, if necessary with a minimal amount of mild soap solution.

ALCOHOLS SUCH AS ISOPROPYL ALCOHOL MUST NEVER BE USED ON THE SCREEN.

B2.2 MAINTENANCE SCHEDULE

Battery replacement - Every three years

B2.2.1 BATTERY REPLACEMENT PROCEDURE

WARNING

In order to eliminate the risk of user contact with hazardous voltages, the recorder must be isolated from line power before its top cover is removed.

The battery is of poly-carbonmonofluoride/lithium construction and should be disposed of according to local regulations covering this type of battery.

Note: All battery backed RAM data is lost during battery change (see Annex A for details of stored data)..

1. Isolate the recorder from supply power and remove the recorder from the panel (if fitted)
2. Remove the recorder cover by removing the Four Torx headed screws (A) and the Pozidriv-headed screw B, and then lifting the cover up and out, under the gasket (C).

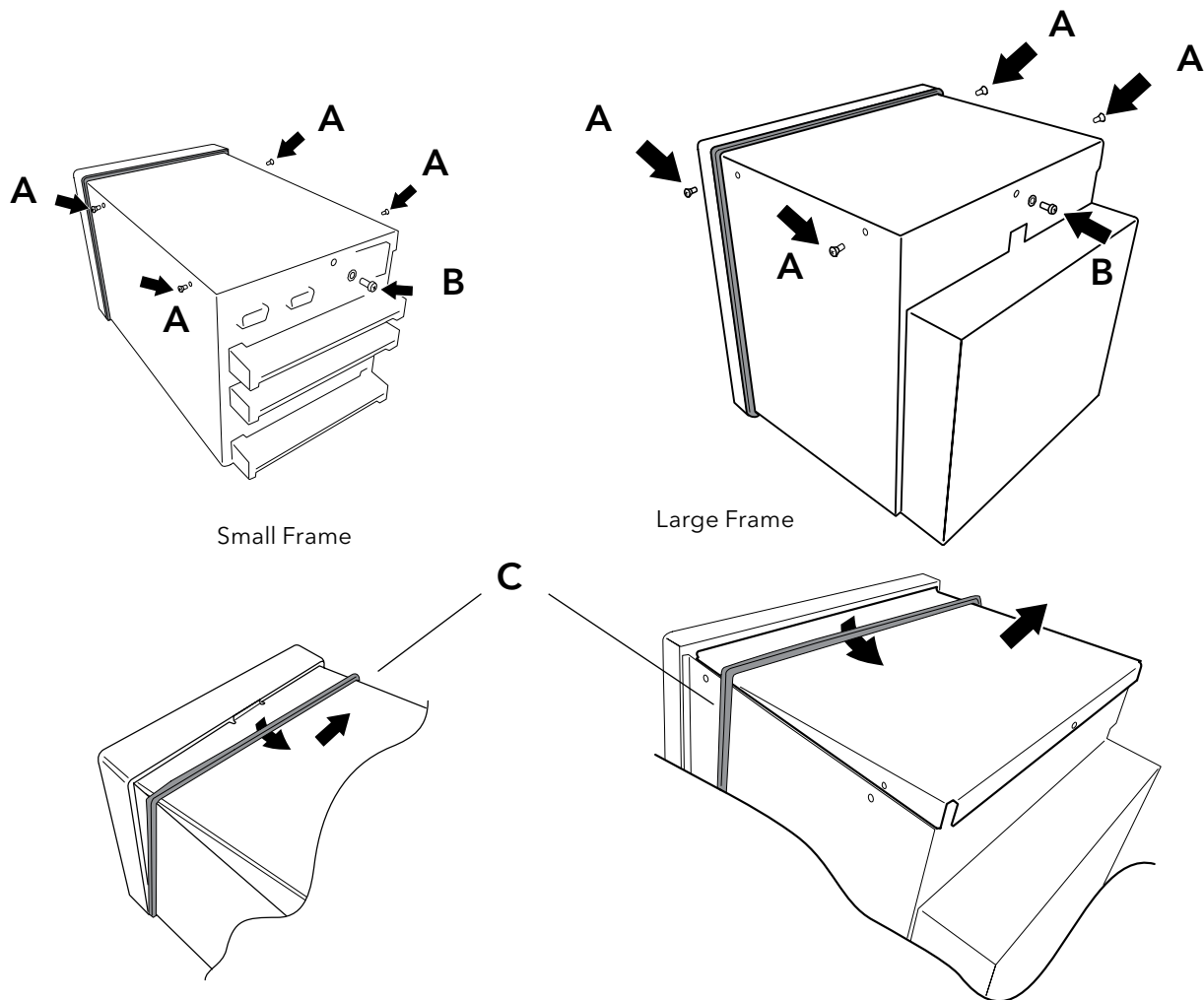

Note: Drawings are not to the same scale.

B2.2.1 BATTERY REPLACEMENT (Cont.)

3. With the cover removed, the battery board is accessible, allowing the exhausted battery to be slid out of its holder and the replacement battery to be inserted (+ up).

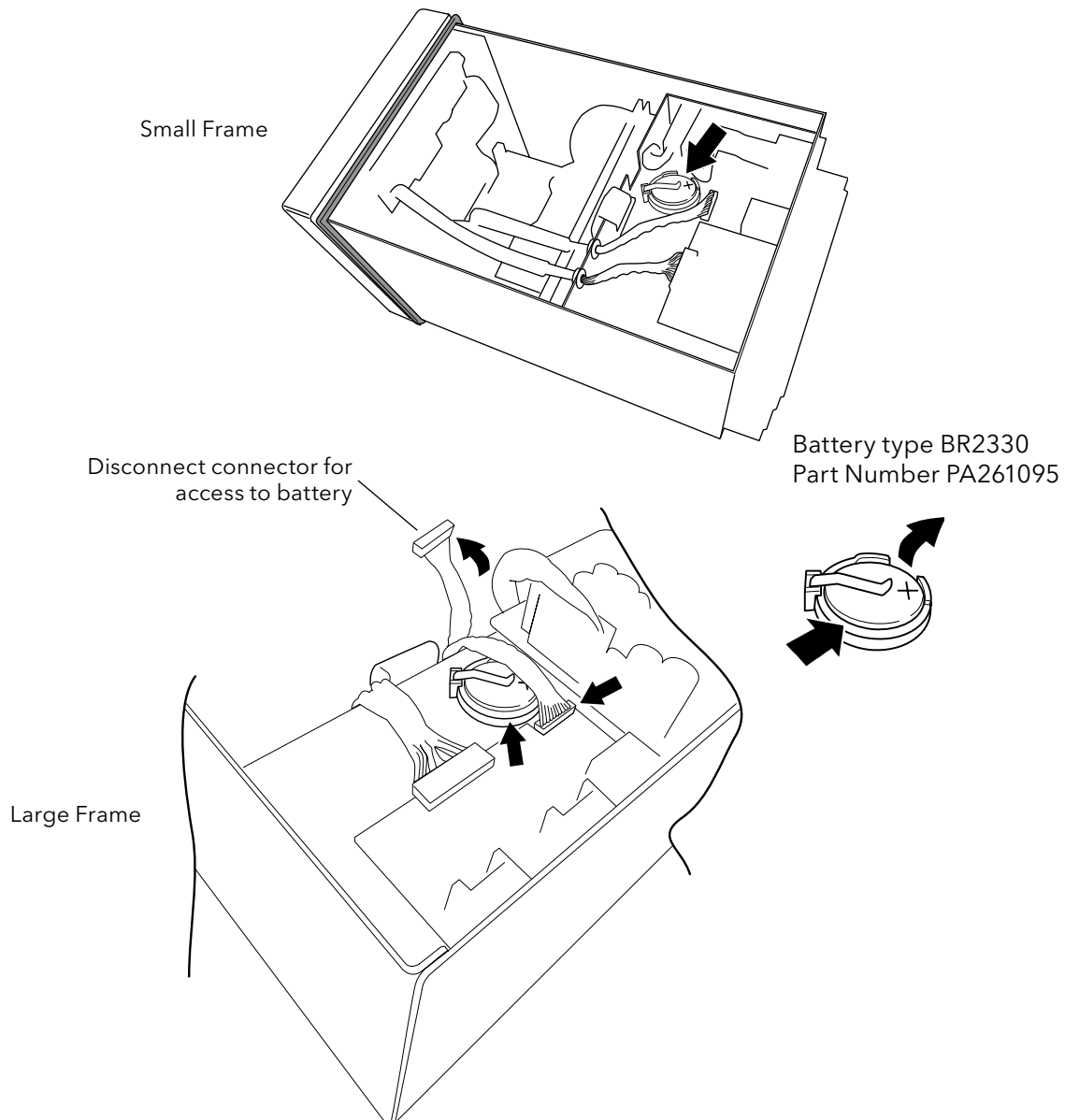

Note: drawings are not to the same scale.

B2.3 FLAP RELEASE

For recorders fitted with the lockable flap option (section 2.4), it is possible to unlatch the flap from inside the recorder as follows:

1. Remove the recorder cover as described in section B2.2.1, above.
2. Press down on the solenoid actuator to release the flap.

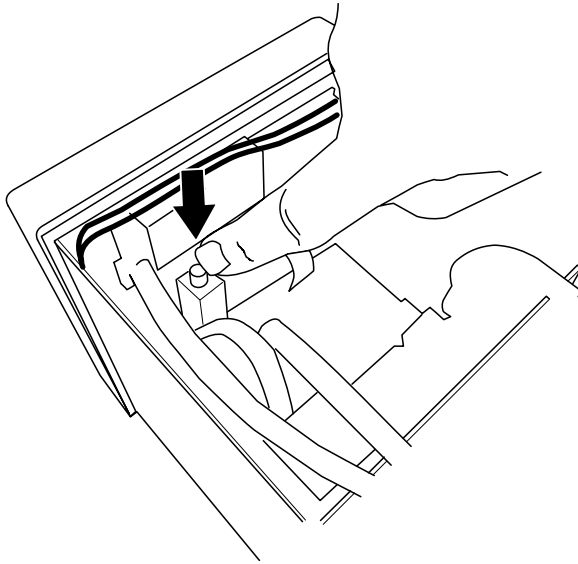

Fig 2.3a Flap release - small frame units

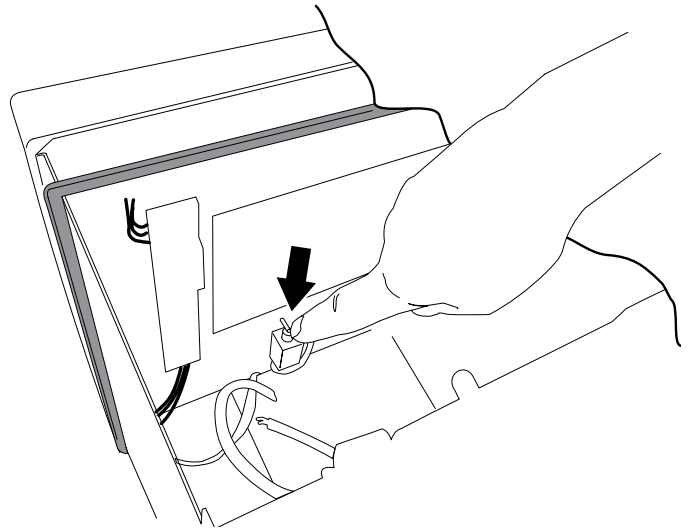

Fig 2.3b Flap release - large frame units

Note: drawings are not to the same scale.

B3 OPTION ENABLING

See 'Upgrade' in [section 4.6.3](#).

B4 COLOUR SELECTION

The following table, gives RGB values and decimal and hex numbers for the available channel colours. Normally, this table is necessary only when communicating over the Modbus link.

Note: Colour representation varies from screen to screen. For this reason, it is unlikely that the colour on a PC will match those on these pages or those on the recorder display.

B4 COLOUR SELECTION (Cont.)





























	Colour	Red	Green	Blue	Decimal	Hex
	Red	255	0	0	0	00
	Blue	0	0	255	1	01
	Green	0	255	0	2	02
	Honey	255	191	0	3	03
	Violet	170	321	153	4	04
	Russet	170	95	0	5	05
	Dark Blue	0	0	102	6	06
	Jade	0	95	0	7	07
	Magenta	255	0	102	8	08
	Dusky Rose	255	95	51	9	09
	Yellow	255	255	255	10	0A
	Powder Blue	85	63	255	11	0B
	Dark Red	170	0	0	12	0C
	Avocado	0	233	102	13	0D
	Indigo	85	0	102	14	0E
	Dark Brown	85	63	0	15	0F
	Ægean	0	63	51	16	10
	Cyan	0	255	255	17	11
	Aubergine	85	0	51	18	12
	Dark Orange	255	63	0	19	13
	Pale Yellow	255	255	51	20	14
	Hyacinth	170	0	51	21	15
	Dark Green	0	63	0	22	16
	Sugar Pink	255	31	204	23	17
	Bluebell	85	31	255	24	18
	Orange	255	95	0	25	19
	Pink	255	159	255	26	1A
	Buttermilk	255	255	102	27	1B

Table B4, sheet 1: Colour definitions 0 to 27

B4 COLOUR SELECTION (Cont.)























	Colour	Red	Green	Blue	Decimal	Hex
	Terracotta	170	63	0	28	1C
	Blue Babe	85	95	255	29	1D
	Lime	0	223	0	30	1E
	Blue Jive	85	31	204	31	1F
	Cucumber	0	255	153	32	20
	EuroGreen	67	107	103	33	21
	Wheatgerm	255	223	51	34	22
	Sea Blue	85	159	255	35	23
	Ginger	255	159	0	36	24
	Aqua Pool	0	63	255	37	25
	Pale Red	255	63	51	38	26
	Pale Blue	85	127	255	39	27
	Lilac	170	0	255	40	28
	Sky Blue	85	191	255	41	29
	Wild Moss	0	127	0	42	2A
	Turquoise	0	127	153	43	2B
	Pale Green	85	255	153	44	2C
	Coffee	170	127	0	45	2D
	Wicker	255	255	191	46	2E
	Black	0	0	0	47	2F
	Dark Dark Grey	48	48	48	48	30
	Dark Grey	64	64	64	49	31
	Grey	128	128	128	50	32
	Light Light Dark Grey	154	154	154	51	33
	Light Dark Grey	172	172	172	52	34
	Light Grey	192	192	192	53	35
	Light Light Grey	212	212	212	54	36
	White	255	255	255	55	37

Table B4, sheet 2: Colour definitions 28 to 55

B5 TCP PORT NUMBERS

The following TCP ports are made use of by the recorder. (This information would be needed by anyone involved in setting up 'firewalls', which may be used selectively to block incoming or outgoing access to specific ports.)

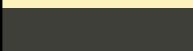
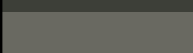
PORT	Usage
20	File Transfer Protocol - data and Bridge communications.
21	File Transfer Protocol - control and Bridge communications
25	E-mail; SMTP
80	Web access
123	SNTP server
502	Modbus/TCPIP communications
1264	Bridge communications - general
2222	EtherNet/IP communications
44818	EtherNet/IP communications
50010	Bridge communications - trend review

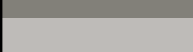
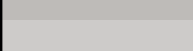
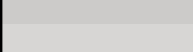
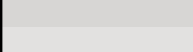
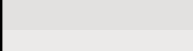
B6 ASCII CHARACTERS FOR SERIAL COMMS

This section contains details of the ASCII characters that may be used with the Serial Comms option. All the ASCII characters listed can be used as Start or End-of-message characters, but only characters with decimal codes 32 to 127 can be used in messages, as decimal codes 0 to 31 are replaced by Question marks in messages.

Character	Decimal	Hex	Character	Decimal	Hex	Character	Decimal	Hex	Character	Decimal	Hex
NUL	0	00	Space	32	20	@	64	40	'	96	60
SOH	1	01	!	33	21	A	65	41	a	97	61
STX	2	02	"	34	22	B	66	42	b	98	62
ETX	3	03	#	35	23	C	67	43	c	99	63
EOT	4	04	\$	36	24	D	68	44	d	100	64
ENQ	5	05	%	37	25	E	69	45	e	101	65
ACK	6	06	&	38	26	F	70	46	f	102	66
BEL	7	07	'	39	27	G	71	47	g	103	67
BS	8	08	(40	28	H	72	48	h	104	68
HT	9	09)	41	29	I	73	49	i	105	69
LF	10	0A	*	42	2A	J	74	4A	j	106	6A
VT	11	0B	+	43	2B	K	75	4B	k	107	6B
FF	12	0C	,	44	2C	L	76	4C	l	108	6C
CR	13	0D	-	45	2D	M	77	4D	m	109	6D
SO	14	0E	.	46	2E	N	78	4E	n	110	6E
SI	15	0F	/	47	2F	O	79	4F	o	111	6F
DLE	16	10	0	48	30	P	80	50	p	112	70
DC1	17	11	1	49	31	Q	81	51	q	113	71
DC2	18	12	2	50	32	R	82	52	r	114	72
DC3	19	13	3	51	33	S	83	53	s	115	73
DC4	20	14	4	52	34	T	84	54	t	116	74
NAK	21	15	5	53	35	U	85	55	u	117	75
SYN	22	16	6	54	36	V	86	56	v	118	76
ETB	23	17	7	55	37	W	87	57	w	119	77
CAN	24	18	8	56	38	X	88	58	x	120	78
EM	25	19	9	57	39	Y	89	59	y	121	79
SUB	26	1A	:	58	3A	Z	90	5A	z	122	7A
ESC	27	1B	;	59	3B	[91	5B	{	123	7B
FS	28	1C	<	60	3C	\	92	5C		124	7C
GS	29	1D	=	61	3D]	93	5D	}	125	7D
RS	30	1E	>	62	3E	^	94	5E	~	126	7E
US	31	1F	?	63	3F	_	95	5F	Not printed	127	7F

Notes:

- 1 All the above characters can be used as Start or End-of-message characters (entered in decimal)
- 2 If characters 0 to 31 (00 to 1F) are used as message characters, they will be replaced by question marks on the screen.

B7 TIME ZONE INFORMATION

This section gives an explanation of the time zone abbreviations listed in the System/Locale/Time Zone pick list. The list starts at GMT, travelling Eastwards round the world.

Abbreviation	Full title	Time at noon GMT	Hours of difference
GMT	Greenwich mean time	12:00	0
UTC	Co-ordinated Universal time	12:00	0
ECT	Central European time	13:00	+1
EET	Eastern European time	14:00	+2
ART	Arabic standard time	14:00	+2
EAT	Eastern African time	15:00	+3
MET	Middle East time	15:30	+3.5
NET	Near East time	16:00	+4
PLT	Pakistan Lahore time	17:00	+5
IST	India standard time	17:30	+5.5
BST	Bangladesh standard time	18:00	+6
VST	Vietnam standard time	19:00	+7
CTT	China Taiwan time	20:00	+8
JST	Japan standard time	21:00	+9
ACT	Australia Central time	21:30	+9.5
AET	Australia Eastern time	22:00	+10
SST	Solomon standard time	23:00	+11
NST	New Zealand standard time	24:00	+12
MIT	Midway Islands time	01:00	-11
HST	Hawaii standard time	02:00	-10
AST	Alaska standard time	03:00	-9
PST	Pacific standard time	04:00	-8
PNT	Phoenix standard time	05:00	-7
MST	Mountain standard time	05:00	-7
CST	Central standard time	06:00	-6
EST	Eastern standard time	07:00	-5
IET	Indiana Eastern standard time	07:00	-5
PRT	Puerto Rico and US Virgin Islands time	08:00	-4
CNT	Canada Newfoundland time	08:30	-3.5
AGT	Argentina standard time	09:00	-3
BET	Brazil Eastern time	09:00	-3
CAT	Central African time	11:00	-1

B8 HISTORY MAINTENANCE OPTION

This option, which must be specified at time of order, is intended for use by hire companies etc. who have a requirement to remove all customer data from recorders which are not fitted with the 'Simulation' option (which includes an 'Erase all history' job). See [section 4.3.22](#) for a description of the Simulation option. The History maintenance option is not enabled in Trial Mode' ([section 4.3.22](#)).

The erase history procedure consists of entering a special keycode into the System\Upgrade\Key Code area ([section 4.6.3](#)) and operating the 'Apply' button.

CAUTION

The option should be used with discretion, as once the history has been erased, it can never be regained.

B8.1 KEYCODE EXTRACTION

Notes:

1. This operation can be carried out only from the recorder's operator interface. It is not possible to extract the keycode or to erase history from a remote pc.
 2. To be able to carry out the procedure below, users must have 'Paste/Delete Files' permission enabled in the 'Security' menu ([section 4.4.1](#)).
 3. The keycode displayed in the System/Upgrade menu returns to its previous value after a history erase operation.
-
1. Recorders fitted with this option come complete with a file called 'HMT.TXT in the 'user/' area of the filing system, accessed as described in section 5.
 2. Highlight this file, and copy it using the Filer Options menu 'Copy' key.
 3. With a memory device (e.g. SD card, Memory stick etc.) inserted, use the Filer Options menu 'Paste' key to save the file into the removable media area.
 4. Move the storage device from the recorder to a pc, and open the file in an appropriate program (e.g. 'Notebook') to reveal a key code.
 5. This keycode can be kept in a secure area for re-use in subsequent erase operations for this recorder.

Filer Options	
New	Delete
Cut	Copy
Paste	Refresh

Figure B8.1
Filer option menu

B8.2 ERASING HISTORY

1. Enter the key code into the recorder's System\Upgrade\Key Code area and operate the 'Apply' button.
2. Operate the 'Ok' button in the dialogue box (figure B8.2). This initiates the erasure of the recorder's history files, after which the recorder restarts.

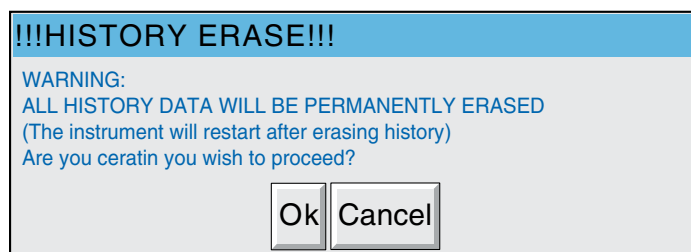

Figure B8.2 Confirmation dialogue box

Note: This operation erases only the recorder's history files; the recorder's configuration remains unchanged. The Save/Restore 'New' selection ([section 4.2](#)), with all tickboxes ticked must be used to reset the configuration to default values (if required).

B9 MENU STRUCTURE

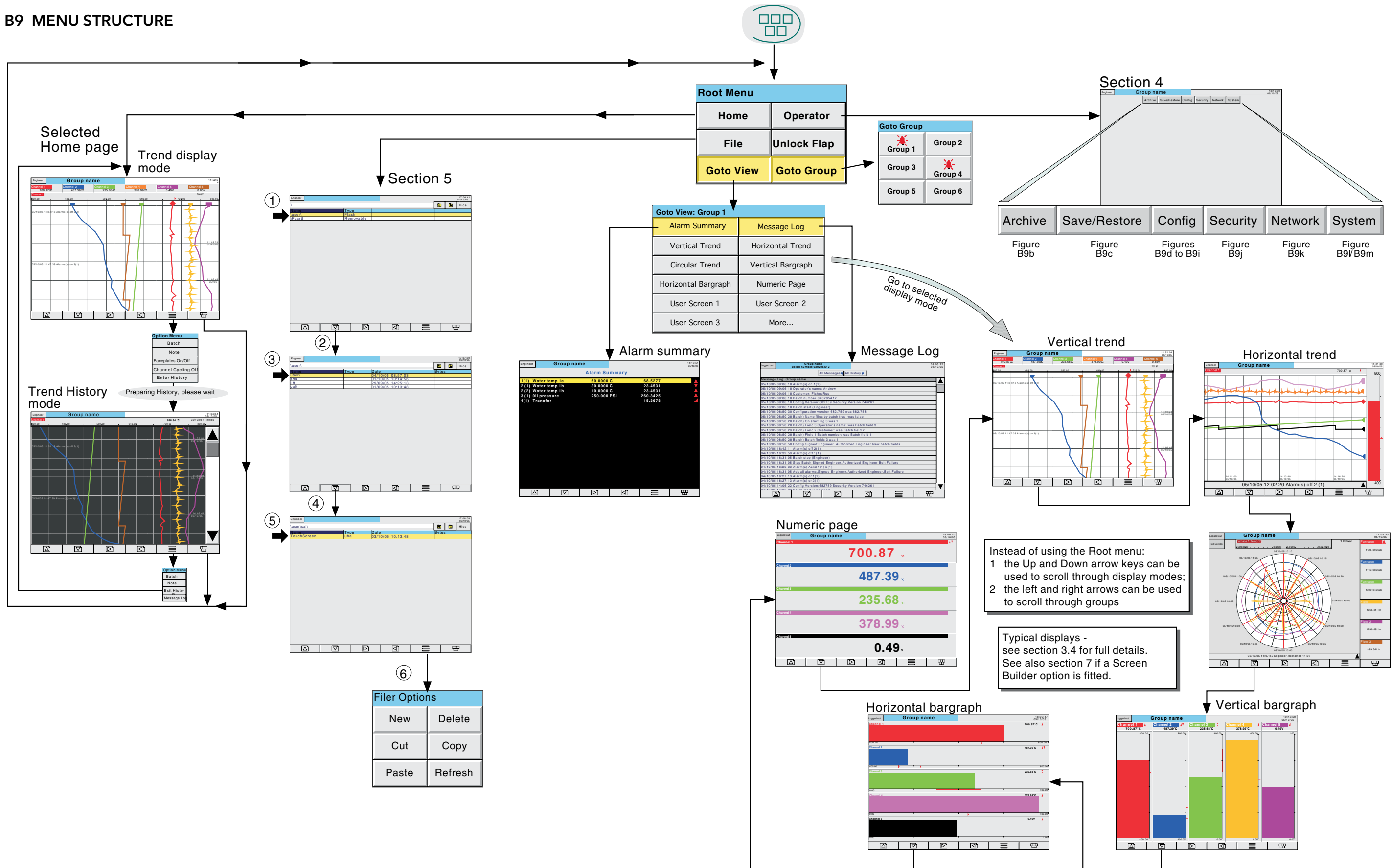

Figure B9a Root key menu structure

B9 MENU STRUCTURE (Cont.)

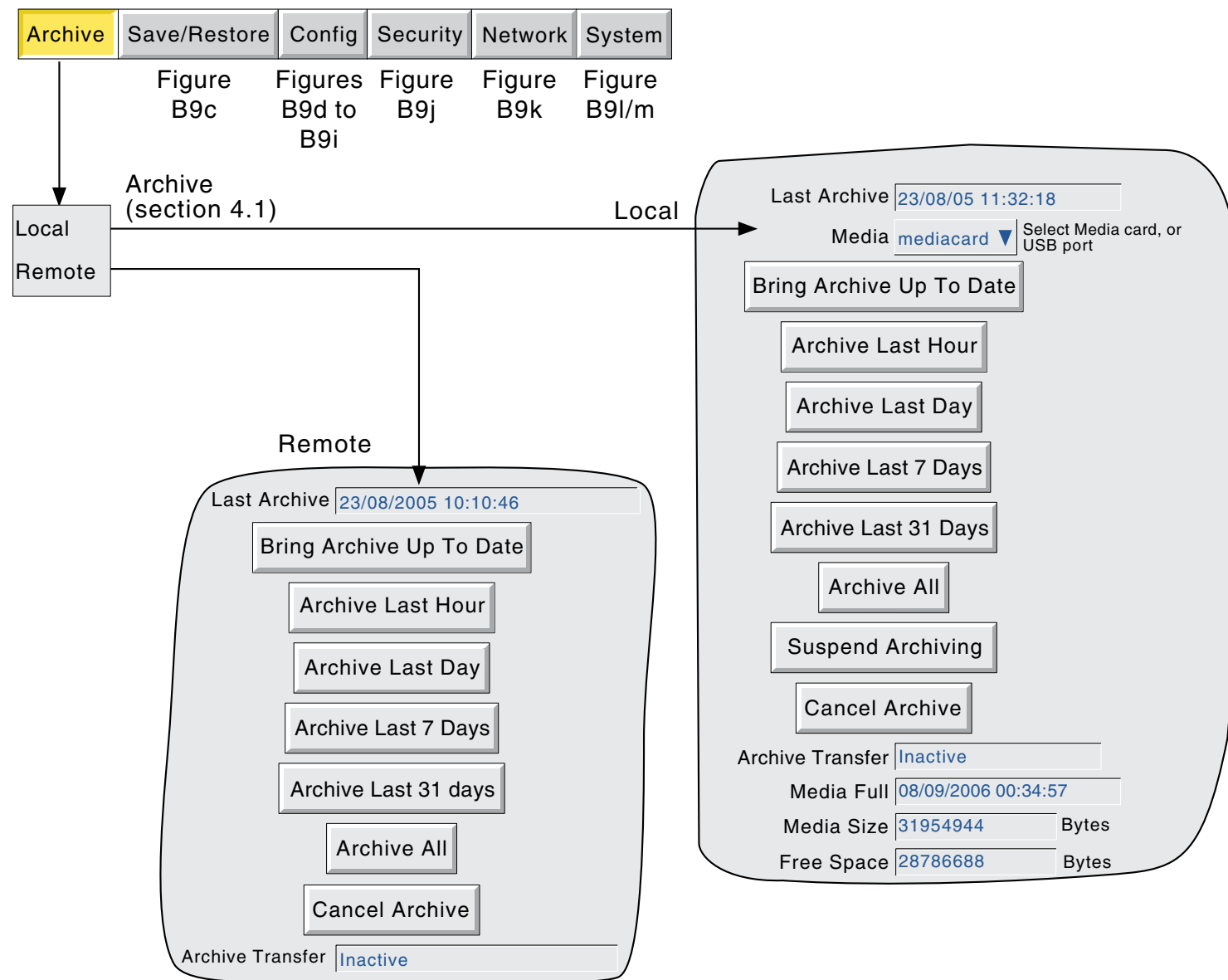

Figure B9b Archive key menu structure

B9 MENU STRUCTURE (Cont.)

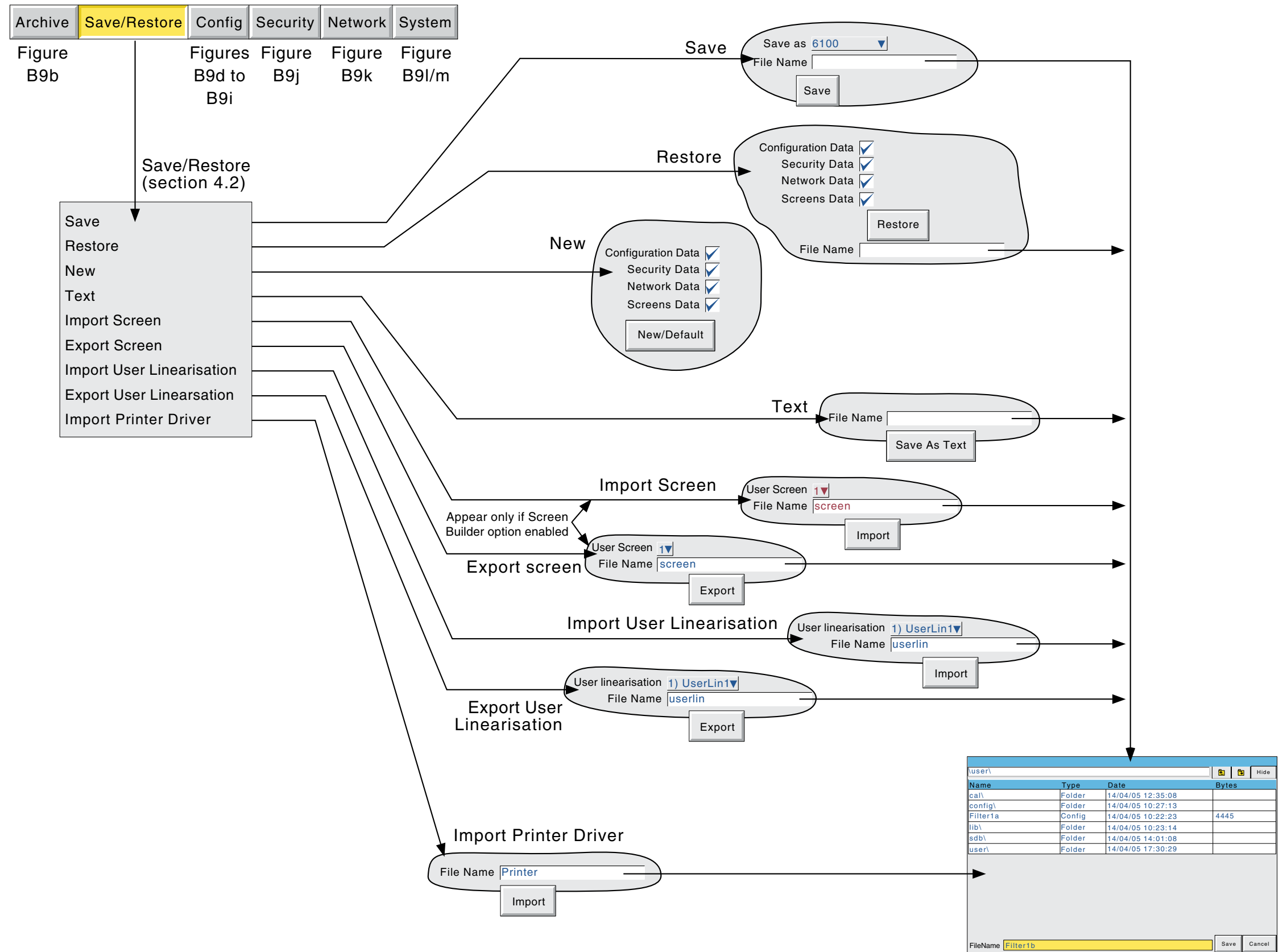

Figure B9c Save/Restore menu structure

B9 MENU STRUCTURE (Cont.)

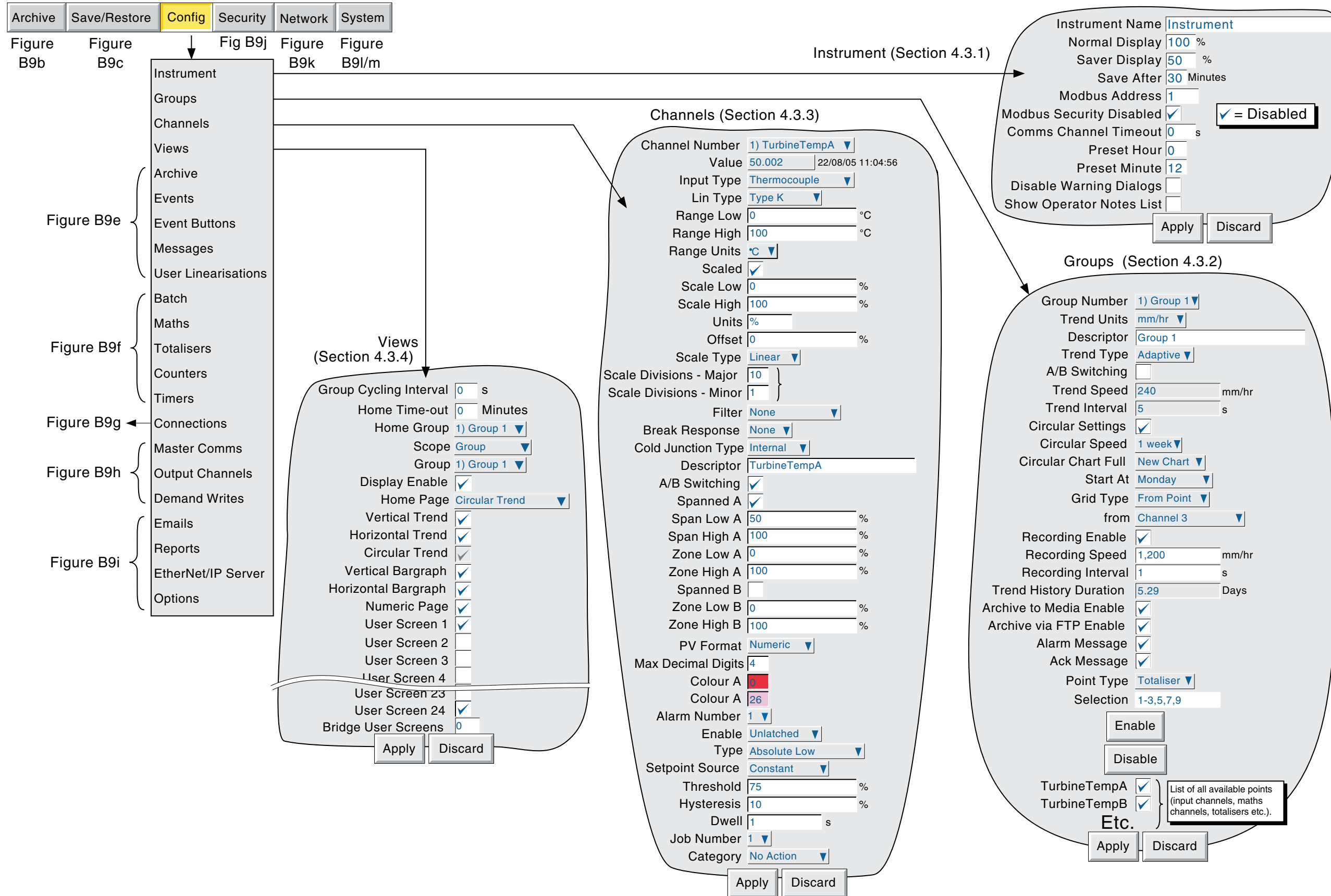

Figure B9d Config menu structure (sheet 1)

B9 MENU STRUCTURE (Cont.)

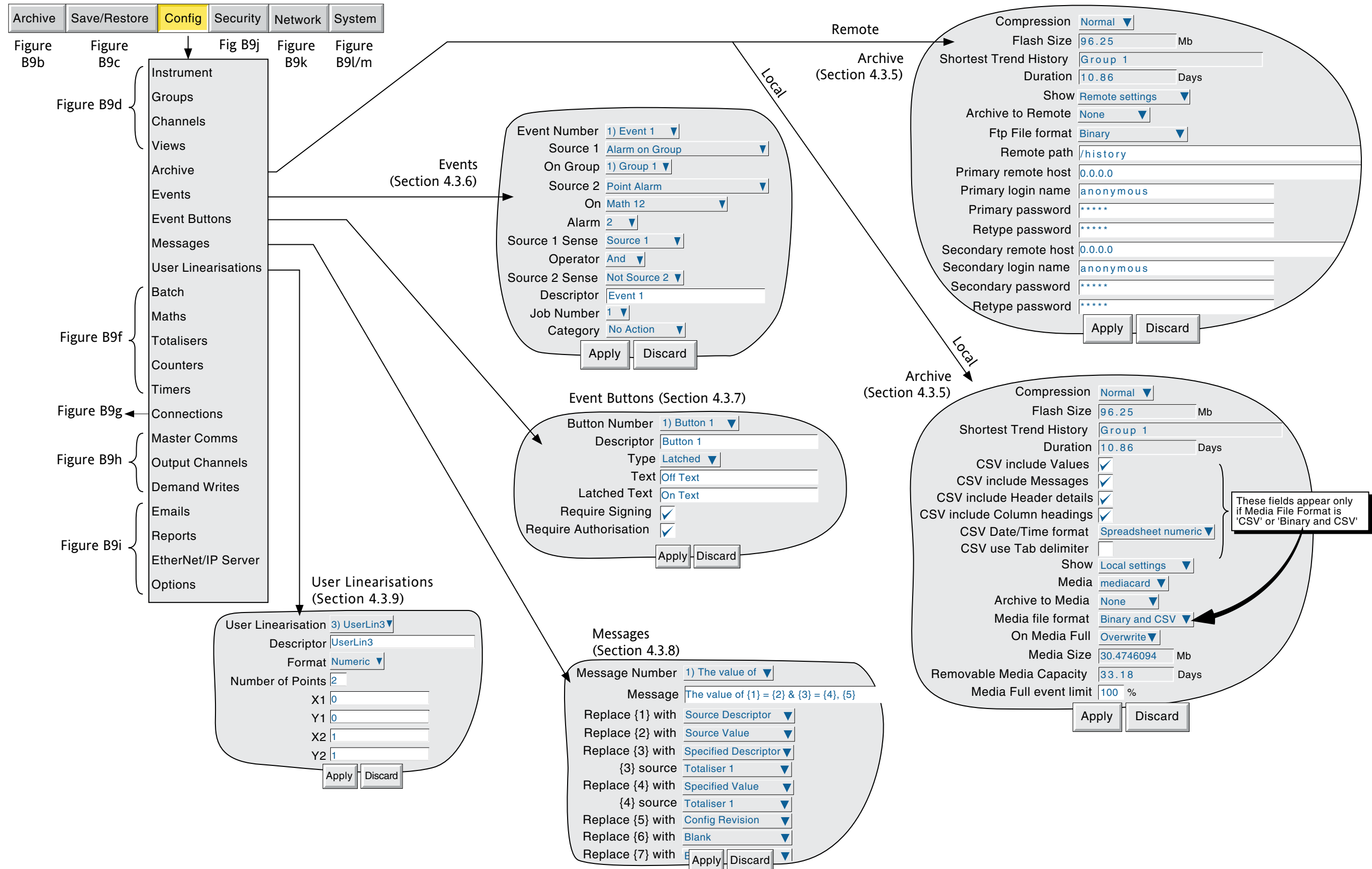
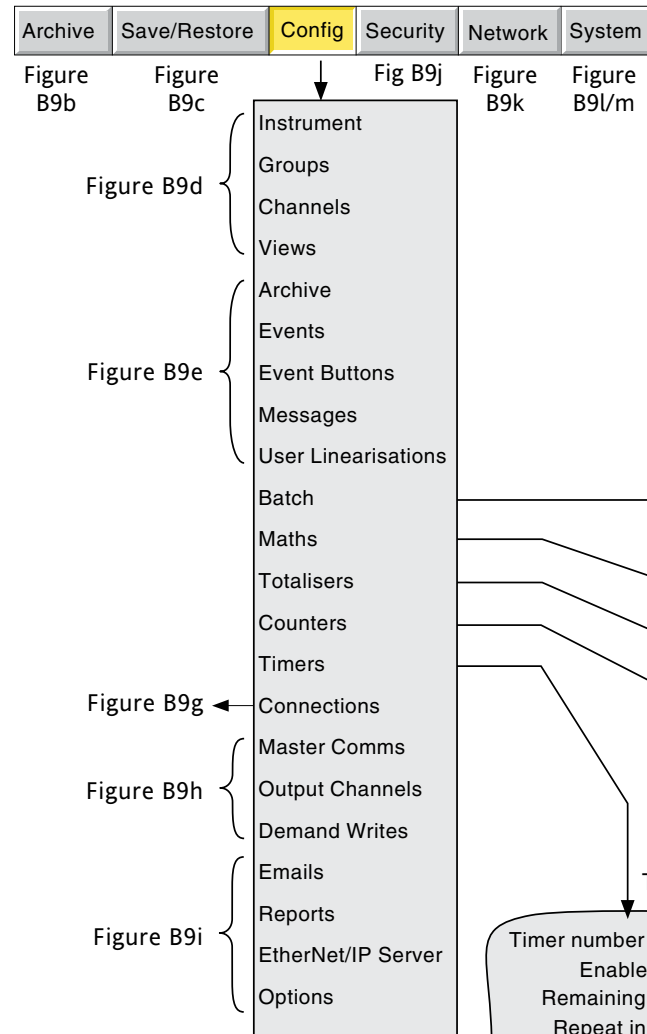

Figure B9e Config menu structure (sheet 2)

B9 MENU STRUCTURE (Cont.)



Batch (Section 4.3.10)

Scope: Group
 Group: 1) Group1
 Show Batch Entry List:
 Enable:
 Batch mode: Start/Stop
 Batch fields: 4
 Field 1: Batch Number
 Batch field 1: Use Counter
 Counter: Counter 1
 Field 2: Customer Name:
 Field 3: Operator Name:
 Field 4: Supervisor:
 On start log: 4
 On stop log: 1
 On new clear: 1
 Name files by batch:
 Pre calibration:
 Post calibration: (Appear only with TUS option)
 Apply Discard

Maths (Section 4.3.11)

Maths Number: 1) Fo 1
 Value: 32.65 Mins
 Function: fValue
 Value of: Channel 1
 Sterilizing Temp: 121.1
 Temperature interval: 10
 Low cut off: 75
 Units: Mins
 Descriptor: Fo 1
 A/B Switching:
 Scale Low: 0 Mins
 Scale high: 60
 Scale Type: None
 Zone low: 0 %
 Zone high: 100 %
 PV Format: Numeric
 Max Decimal Digits: 2
 Colour: 26
 Alarm Number: 1
 Enable: Off
 Job Number: 1
 Category: No Action
 Apply Discard

Reset now (Reset button appears only for resettable functions)

Timers (Section 4.3.14)

Timer number: 1) Timer 1
 Enable:
 Remaining: 00:00:00
 Repeat in: 00:00:00
 Reset now
 Start now
 Descriptor: Timer 1
 Self start:
 Date: Any
 Month: Any
 Hour: Any
 Minute: Any
 Second: Any
 Duration: 60 Seconds
 Repeat after: 0 Seconds
 Job Number: 1
 Category: No Action
 Apply Discard

These fields appear only if 'Self start' is enabled.

Counters (Section 4.3.13)

Counter number: 1) Counter 1
 Enable:
 Value: OFF Units
 Units: Units
 Preset: 0 Units
 Preset now
 Descriptor: Counter 1
 A/B Switching:
 Scale Low: 0 Units
 Scale High: 1 Units
 Scale Type: None (Select None or Linear)
 Zone Low: 0 %
 Zone High: 100 %
 Colour: 0
 Alarm Number: 1 (Select Alarm number)
 Enable: Off (Select: Off, Unlatched, Latched, Trigger)
 Job Number: 1 (Select Job number)
 Category: No Action (Select Job category)
 Apply Discard

Totalisers (Section 4.3.12)

Totaliser Number: 1) Totaliser 1 (Select totaliser number)
 Enable:
 Value: 123456 Units (totaliser)
 Total of: Channel 1 (Select channel etc. to be totalised)
 Low cut off: 0 ch units (Units of channel being totalised)
 High cut off: 999999 ch units (Units of channel being totalised)
 Units: Units
 Preset: 0 Units (totaliser)
 Preset now
 Period scaler: 1
 Unit scaler: 1
 Descriptor: Totaliser 1
 A/B Switching:
 Scale Low: 0 Units (totaliser)
 Scale High: 1 Units (totaliser)
 Scale Type: None (Select None, Linear or Log (if log scales option fitted))
 Zone Low: 1 %
 Zone High: 100 %
 PV format: Numeric (Select Numeric or Scientific)
 Max Decimal Digits: 4
 Colour: 0
 Alarm Number: 1 (Select Alarm number)
 Enable: Off (Select: Off, Unlatched, Latched, Trigger)
 Job Number: 1 (Select Job number)
 Category: No Action (Select Job category)
 Apply Discard

Figure B9f Config menu structure (sheet 3)

B9 MENU STRUCTURE (Cont.)

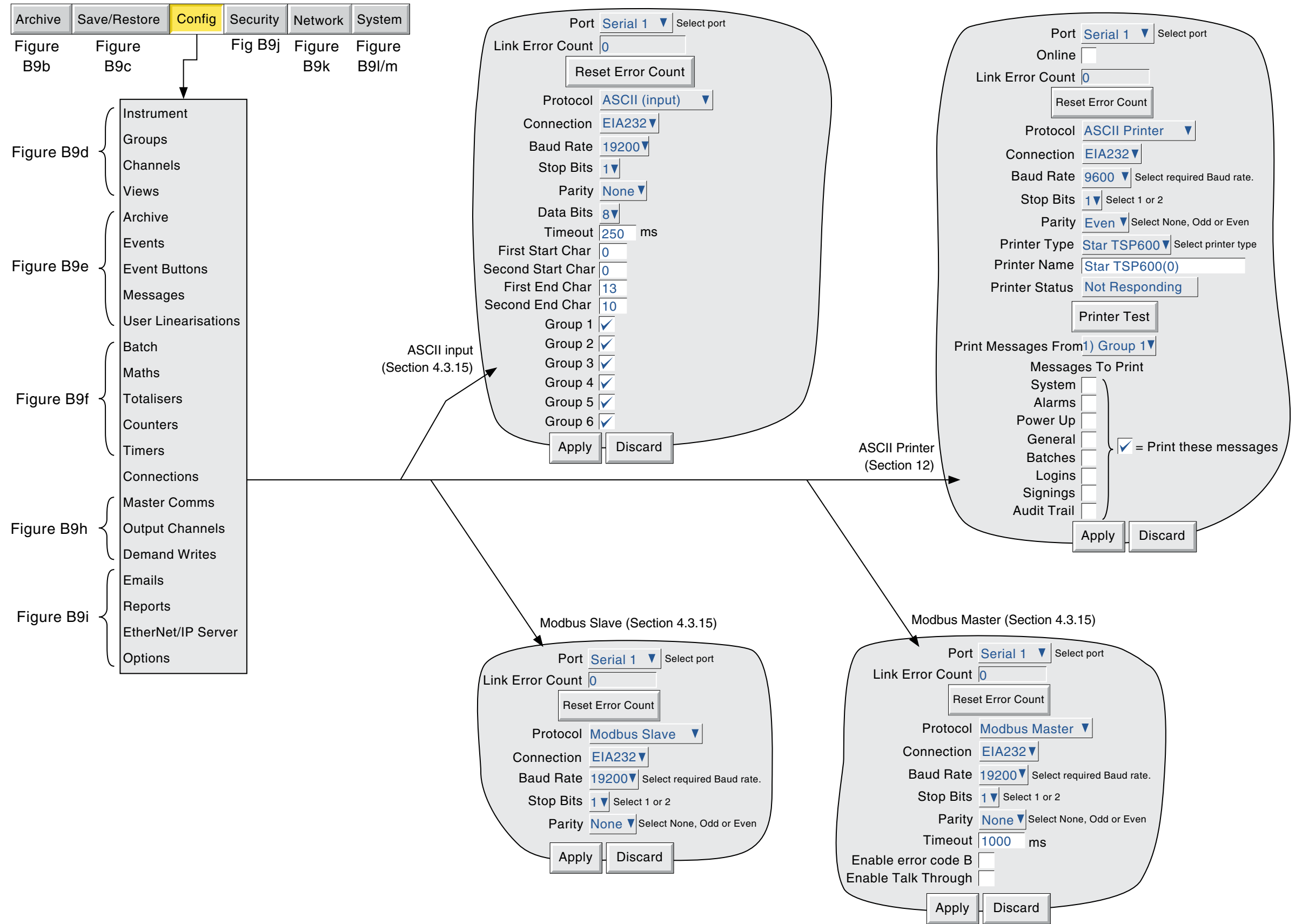

Figure B9g Config menu structure (sheet 4)

B9 MENU STRUCTURE (Cont.)

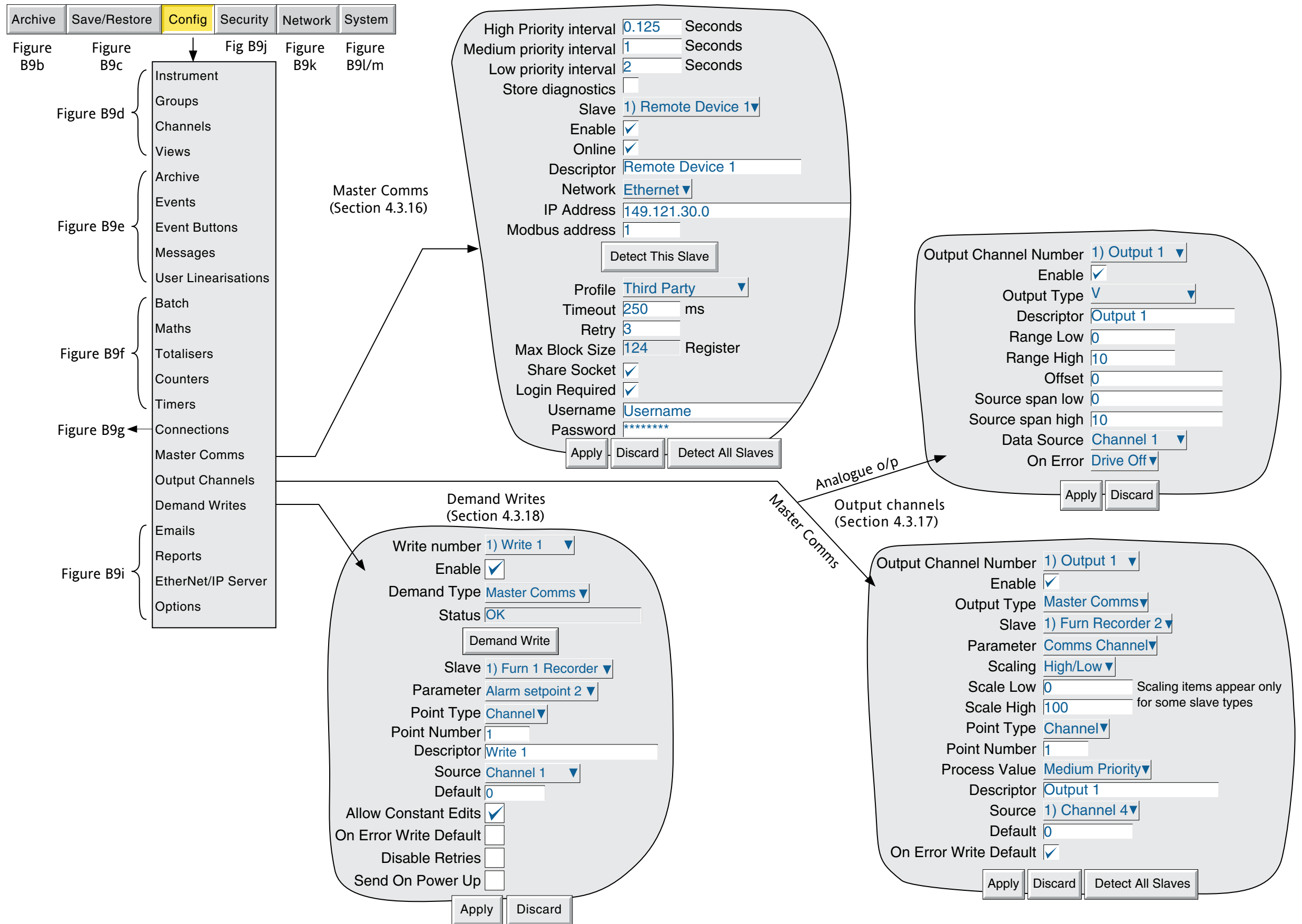

Figure B9h Config menu structure (sheet 5)

B9 MENU STRUCTURE (Cont.)

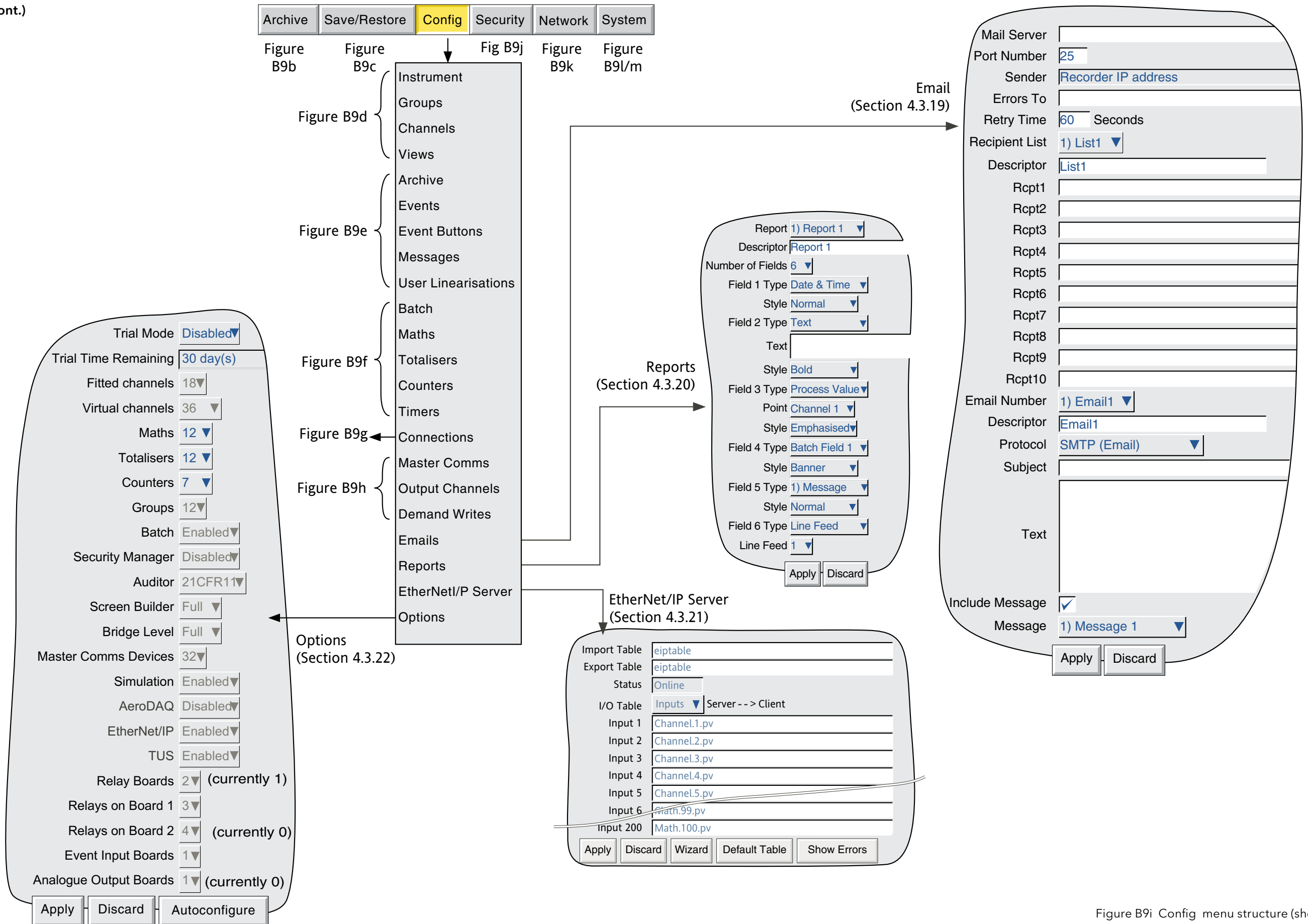

Figure B9i Config menu structure (sheet 6)

B9 MENU STRUCTURE (Cont.)

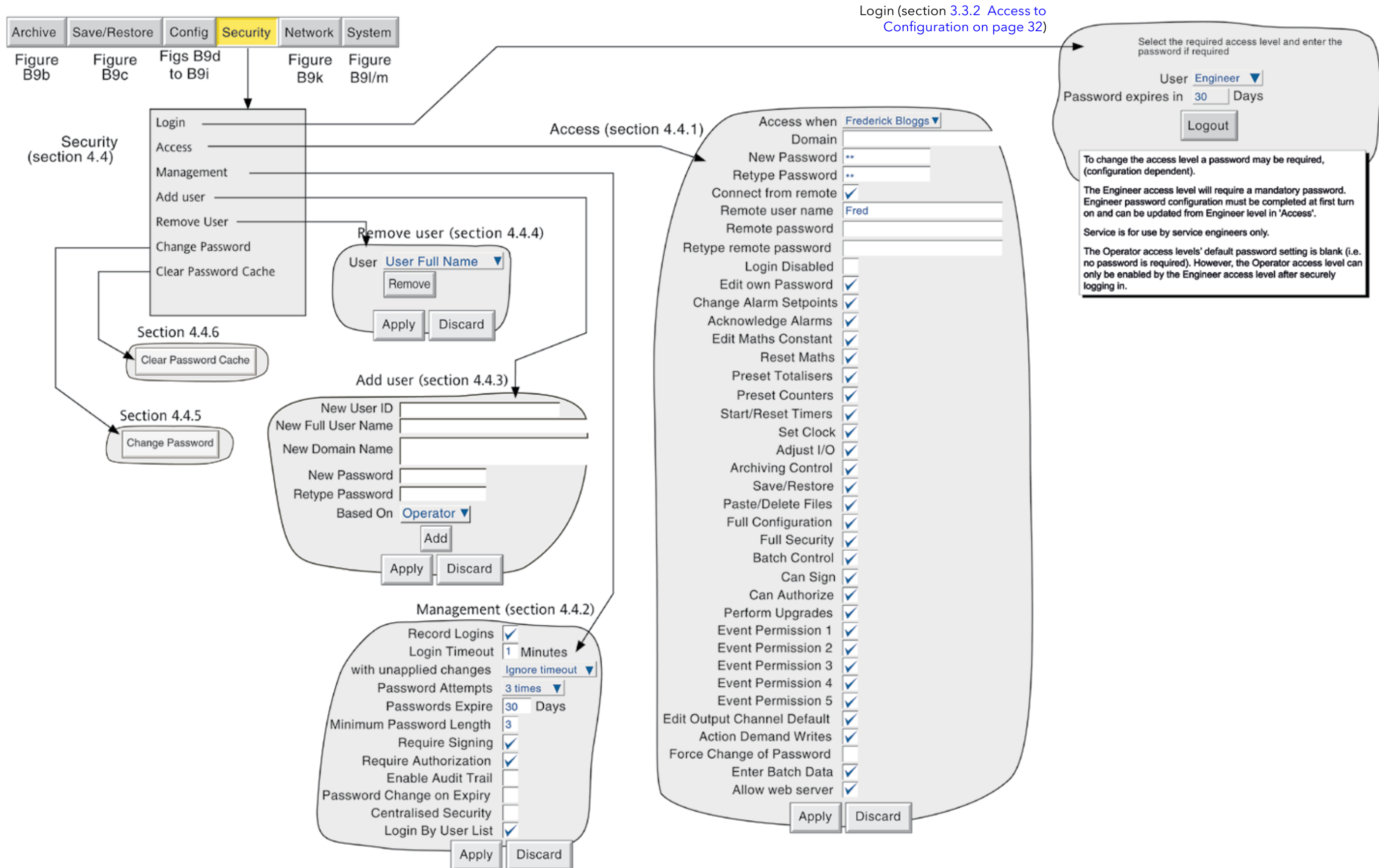

Figure B9j Security key menu structure

B9 MENU STRUCTURE (Cont.)

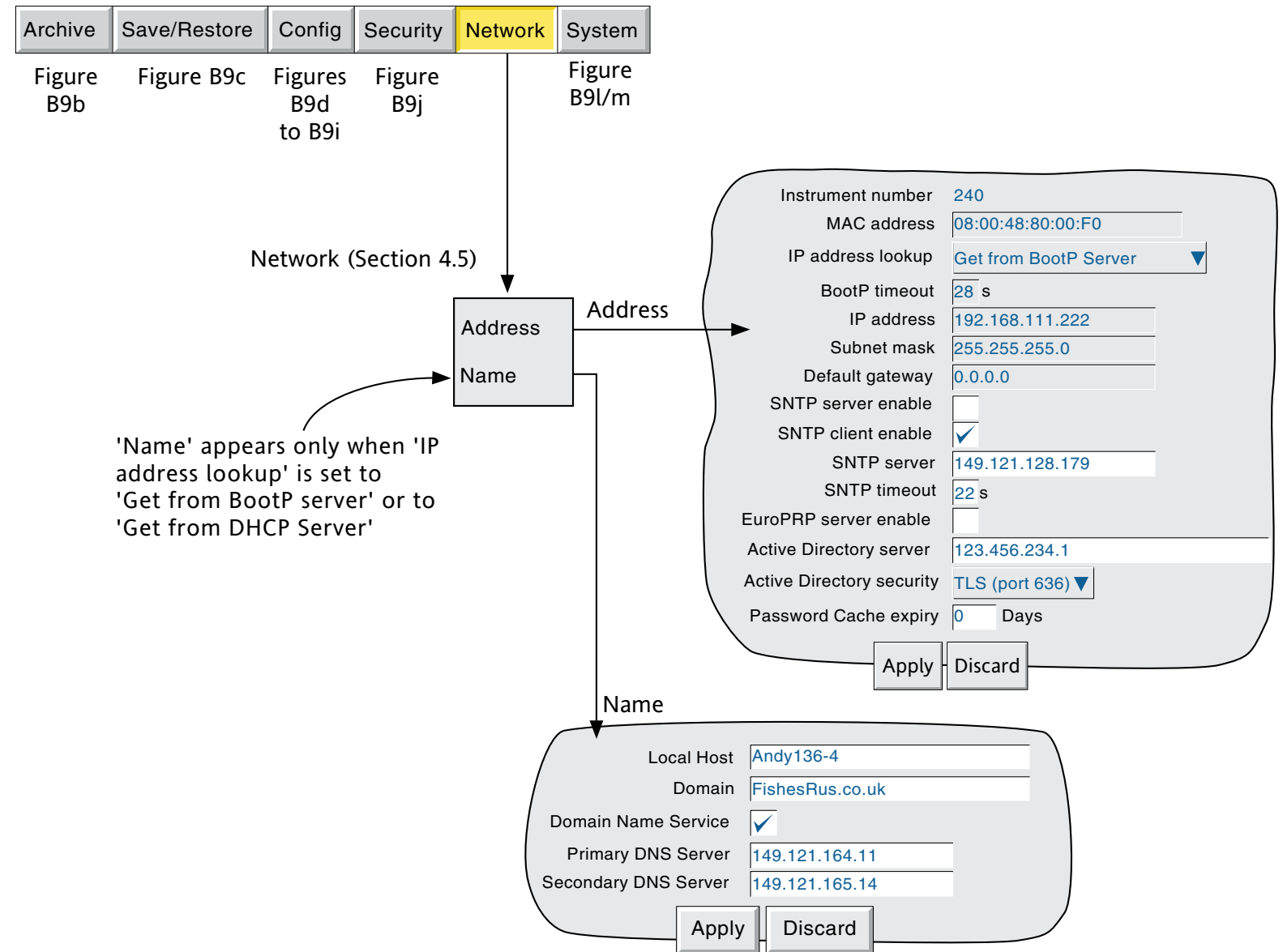

Figure B9k Network key menu structure

B9 MENU STRUCTURE (Cont.)

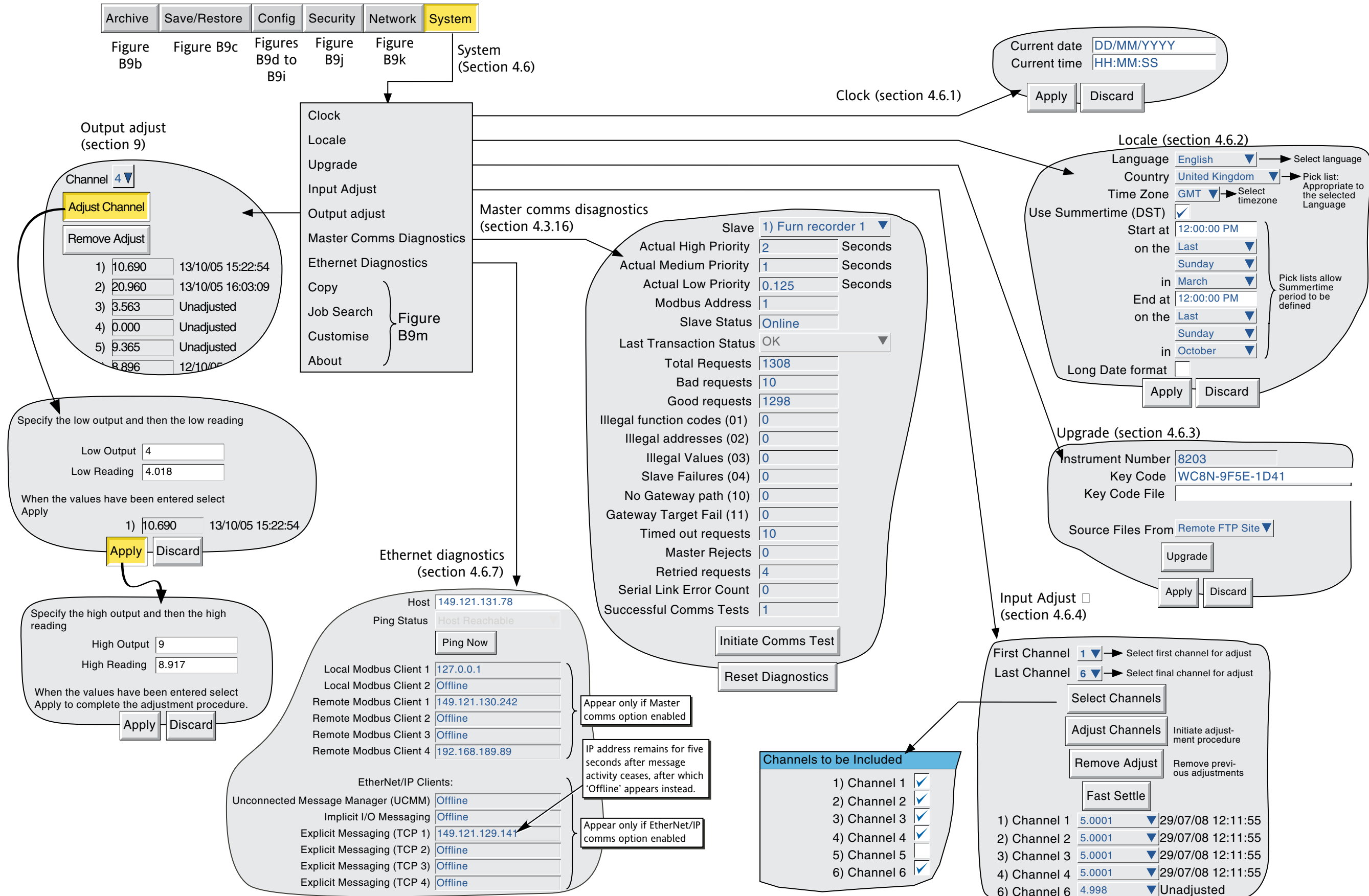

Figure B9I System key menu structure (sheet 1)

B9 MENU STRUCTURE (Cont.)

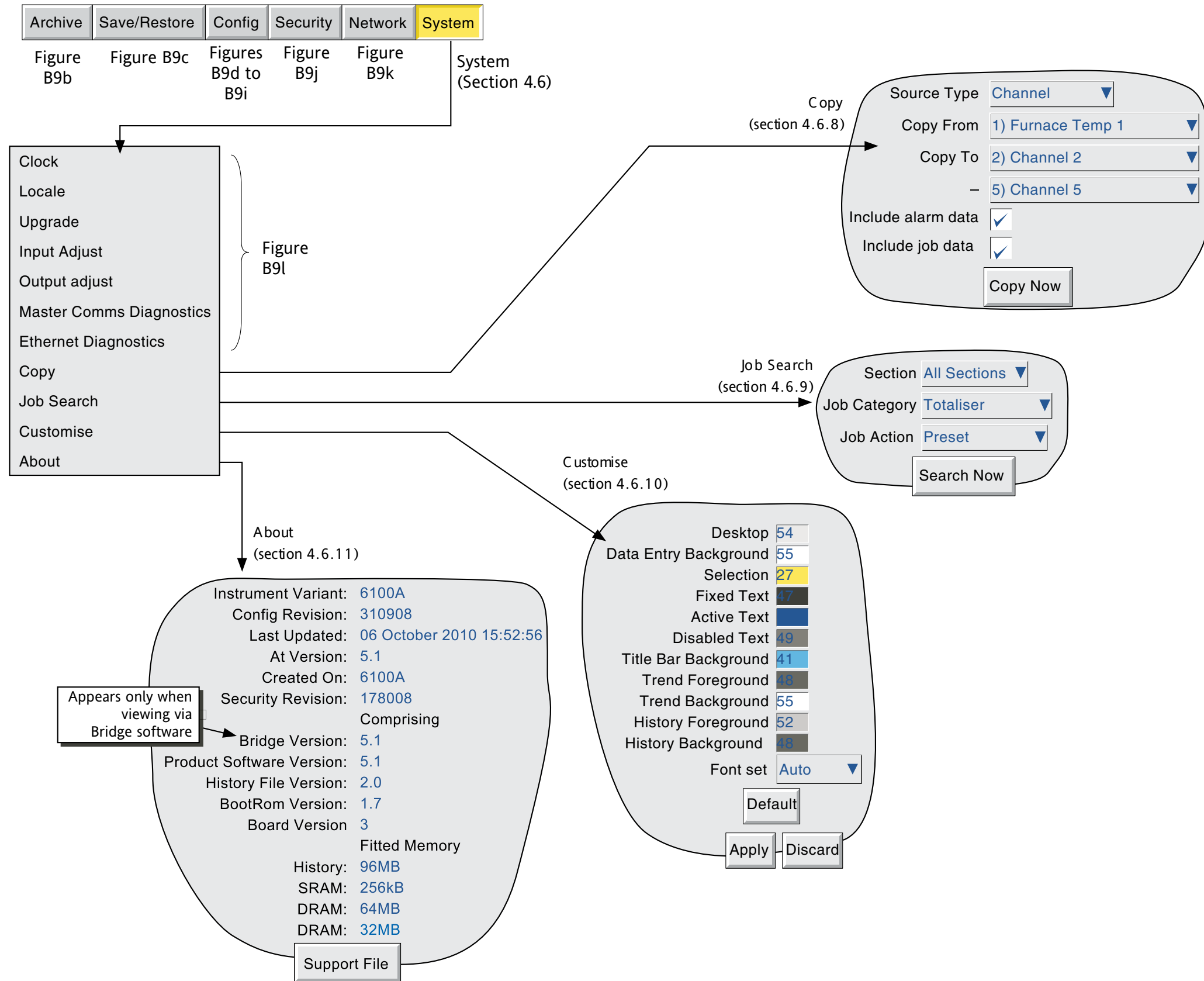

Figure B9m System key menu structure (sheet 2)

This page is deliberately left blank

ANNEX C: WEB SERVER DETAILS

C1 INTRODUCTION

This feature allows a user limited Read Only access to the recorder from a remote PC, by:

1. Opening a standard internet browser
2. Typing-in the IP address of the recorder in the form: `http://xxx.xxx.xxx.xxx`, or the 'Local host' name `http://Local host`. IP address and Local host are described in [section 4.5](#) of this manual.
3. Entering the correct Remote user name and Remote password (as set up in the Security/Access menu described in [section 4.4.1](#)).

If all the entries are correct, the Web Server home page appears, the top part of which is shown in figure C1, below.

Note: The 'Remote user' must have 'Allow web server' permission enabled ([section 4.4.1](#)) and must have sufficient network access to the product.

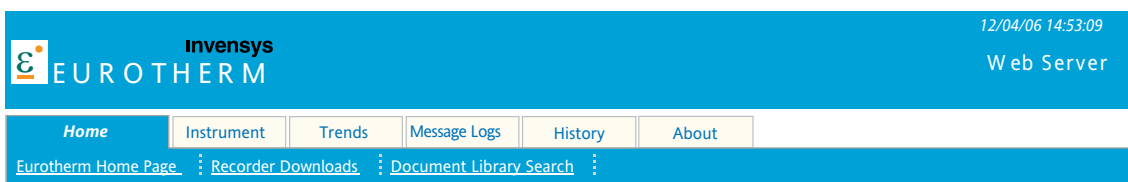

Figure C1 Home page

As can be seen there are two sets of 'controls' viz the internet links and the instrument access tabs.

C2 INTERNET LINKS

These links (Eurotherm Home Page, Recorder Downloads, Document Library Search) take the user to various areas of the manufacturer's web site.

C3 ACCESS TABS

Most of the information displayed in the pages described below is updated every 20 seconds. The exception is the Trend page refresh rate which can be edited (as shown in figure C3.2) by typing in the new value, and then either clicking on 'Set' or using the computer <Enter> key. Because of the processing time required, it is not recommended that a value of less than 5 seconds be entered.

C3.1 INSTRUMENT

This opens the instrument page, a typical example of which is shown in figure C3.1 below.

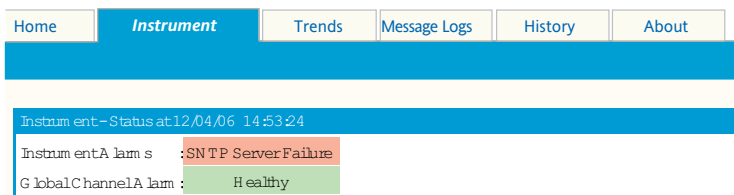

Figure C3.1 Instrument display

C3.1.1 Instrument alarms

Either 'Healthy' (green background) or a list of any active instrument alarm(s) (red background).

C3.1.2 Global channel alarm

Either 'Healthy' (green background) if there are no point alarms, or 'Active' (red background) if there is one or more active point alarm.

C3.2 TRENDS

Clicking on the 'Trends' tab displays a screen allowing the user to select a refresh rate and one of Horizontal trend, Vertical Trend or Numeric as the display format. Both the horizontal and vertical trend modes include the numeric display table.

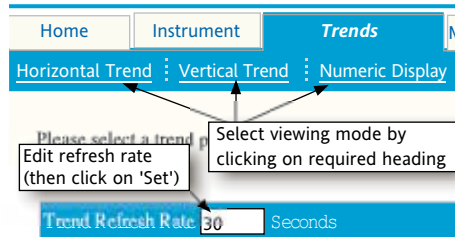

Figure C3.2 Trend mode selection

C3.2.1 Horizontal trend

Figure C3.2.1 shows a horizontal trend display for an imaginary group (Furnace Temps 1) with two channels (Stack 1 and Stack2North)

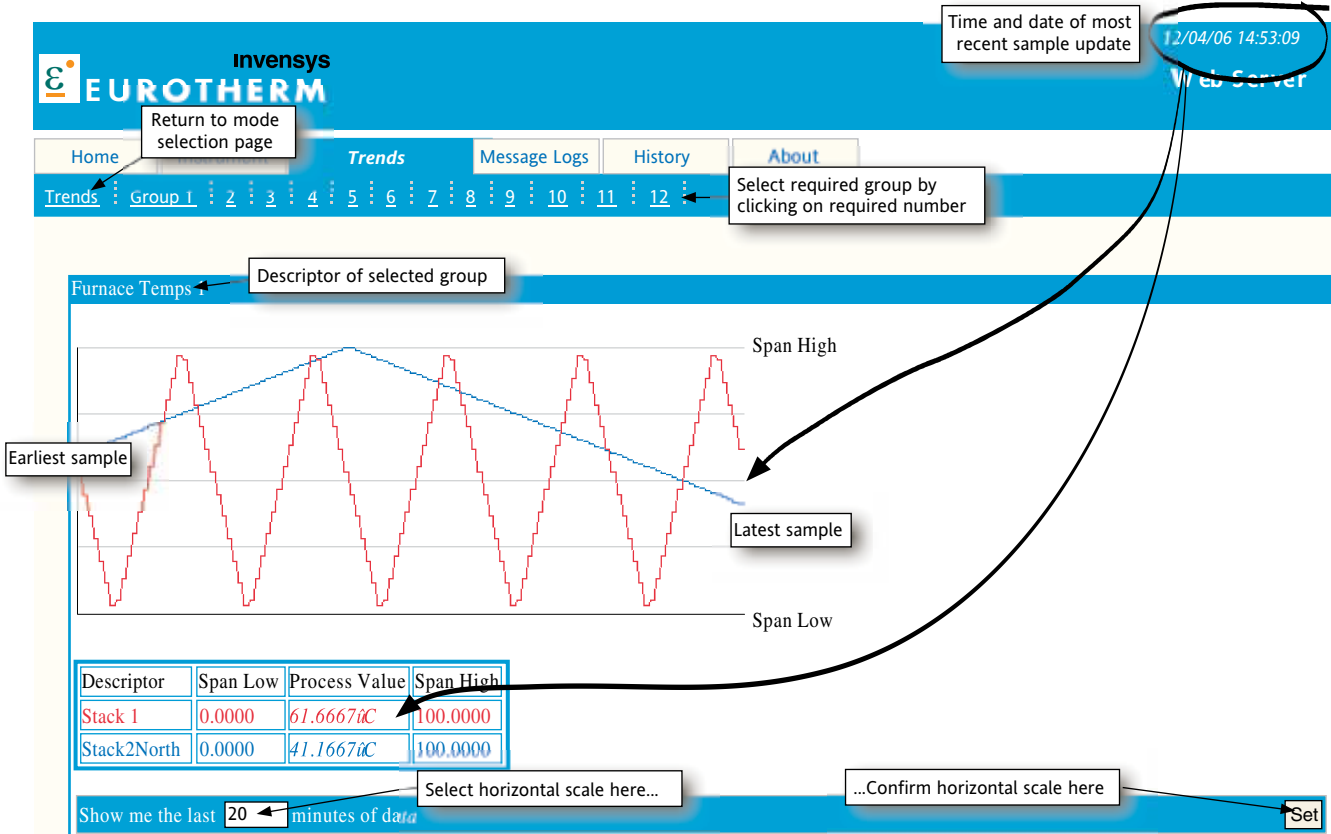

Figure C3.2.1 Horizontal trend example

As shown in the figure, the group process values appear as though being traced on a chart which is rolling from right to left (i.e the oldest sample is at the left edge of the chart, and the latest sample is at the right edge of the chart). The point Descriptors, Span high and Span low values and process values (at the time and date at the top left of the screen) appear in a table below the chart.

The amount of time across the width of the chart (the 'horizontal scale') can be edited from its default of 20 minutes by typing a new value in the box at bottom left of the page, and confirming either by clicking on the 'Set' button at bottom right or by using the pc's <Enter> key.

To return to the Trend Mode selection page, Click on the 'Trends' link at top left.

C3.2.2 Vertical trends

This viewing mode is identical in operation to the Horizontal Trend mode described above, except that the 'chart' is vertical, with the most recent sample at the top, and the oldest at the bottom. The 'Vertical scale' (i.e the amount of trend history displayed within the height of the chart) is edited as described for 'Horizontal scale' in the Horizontal Trend description above.

To return to the Trend Mode selection page, Click on the 'Trends' link at top left.

C3.2.3 Numeric display

This viewing mode contains only a table of point descriptors, spans high and low, and process values. The table is identical in layout to that shown below the 'chart' in figure C3.2.1, above.

To return to the Trend Mode selection page, Click on the 'Trends' link at top left.

C3.3 MESSAGE LOGS

Figure C3.3 shows an imaginary message log with a number of alarm messages, for a group called Furnace Temps 1.

The screenshot displays a web-based interface for viewing message logs. At the top, there is a navigation bar with tabs for 'Home', 'Instrument', 'Trends', 'Message Logs', 'History', and 'About'. Below this, a row of numbers (1-12) allows for selecting a specific group. A callout box points to the number '12' with the text 'Select required group by clicking on required number'. Below the navigation, the selected group 'Furnace Temps 1' is shown, with a callout box pointing to it saying 'Selected group's descriptor'. The main area is titled 'All Messages' and contains a list of messages with timestamps and descriptions:

- 19/04/06 11:21:26 CO2 OK
- 19/04/06 11:21:26 SO2 OK
- 19/04/06 11:21:26 CO OK
- 19/04/06 11:21:26 Alarm(s) off1(1)
- 19/04/06 11:21:26 Alarm(s) off2(1)
- 19/04/06 11:11:13 CO2 over limit
- 19/04/06 11:11:13 SO2 over limit
- 19/04/06 11:11:13 CO over limit
- 19/04/06 11:11:13 Alarm(s) on1(1)
- 19/04/06 11:11:13 Alarm(s) on2(1)

 At the bottom left, there is a text input field labeled 'Show messages at' followed by a box containing the number '20' and the text 'minutes of data'. A callout box points to this box with the text 'Enter history time here...'. At the bottom right, there is a 'Set' button. A callout box points to this button with the text '...Confirm time here'.

Figure C3.3 Message log

The required group is selected by clicking on the relevant number at the top of the page. The length of time that the list covers, can be edited from its default of 20 minutes by typing a new value in the box at bottom left of the page, and confirming by clicking on the 'Set' button at bottom right or using the <Enter> key on the pc. If there are more messages than can be accommodated in the window height, a scrollbar appear at the left edge of the window to allow hidden messages to be revealed.

C3.4 HISTORY

This produces a list of all the .uhh files held in the instrument archive. The files can be saved to a user-specified location, for use in Review or Quickchart applications. Figure C3.4 shows part of a typical page.

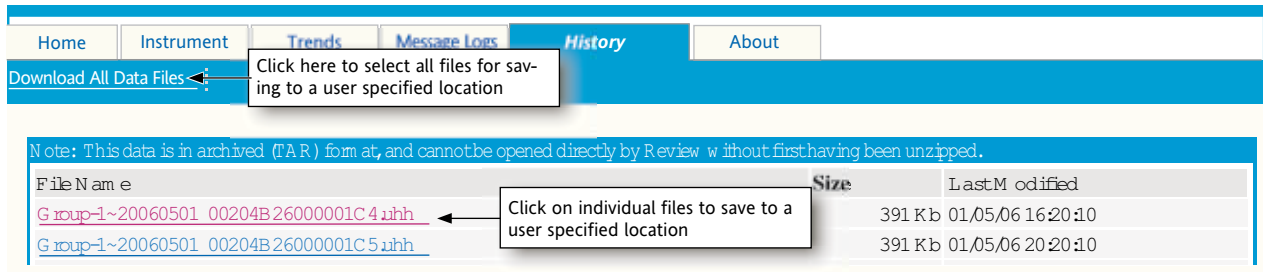

C3.4 History file display

C3.5 ABOUT

Clicking on this tab displays a subset of the information which appears in the recorder's 'About' screen, described in [section 4.6.11](#). The items which appear are:

- Instrument variant
- Serial number
- Product software version
- Boot ROM version
- Board version
- SRAM and DRAM capacities.

INDEX

Symbols

1) Channel 1	221, 372
3D effect	265
10 to the power.....	110
{n} source	95
?Out of Range.....	186
! Symbol.....	16
? Symbol	14, 95, 152
?Syntax Error	186
.uhh files.....	418
.uhq file	230
.uht files.....	187

A

A0 to A5	127
Abort	156
About	229, 413
Absolute high/low.....	78
A/B switching.....	67, 76
Access	
Configuration	198, 410
Flap.....	10
Levels	15, 198
To configuration	32
When.....	199
Ack all alarms	19
ACK Message.....	69
Acknowledge	
Alarms.....	19
Jobs	238
Permission.....	200
AC Supply voltage range	9, 377
Action demand writes	202
Active Directory	
Security.....	215
Server.....	199, 215
Setup.....	210
Active Text colour.....	227
Adaptive recording.....	66
Add	
Key.....	256
Maths function.....	109
Points to groups	70
User.....	208
Configuration menu	410
Address	
Allocation (Modbus).....	290
IP.....	214
MAC	213, 388
Map (Modbus)	288
Network.....	213
Adjust	
Channels.....	221, 372
Inputs	221
Permission.....	200
Outputs	332
Permission.....	200
Remove.....	221
Advanced	
Edit level.....	258
Parameters	265

A (Cont)

Alarm	
Acknowledge	
Jobs	238
Message enable/disable	69
Permission.....	200
Acknowledge (ACK ALL ALARM)	19
Channel indicator.....	18
Configuration	71
Data (Include in copy).....	225
Disable.....	238
Enable.....	78
Icons.....	15
Identifier	20
Indication	16
Instrument.....	16
Summary.....	19
Jobs.....	238
Marks, colour selection.....	265
Messages	81
Enable/disable	69
Message log	25
Number	77
On Group (Event source)	91
Parameters	79
Setpoint	
Edit permission	200
Source.....	78
Sounds.....	249
Summary page	20
System	16
Type.....	78
All	
Messages	25
Points	270
Allow	
Constant edits	175
Web server.....	202
Always	269, 270
Amount Rate-of-change alarms.....	79
Analogue outputs	173, 332
Specification	384
AND.....	93
Apply.....	156
Key (Ethernet IP config.).....	185
Arc	
Angle.....	263
Definition.....	278
Height	263
Width	263
Archive	
All.....	53
Configuration	
Automatic.....	85
Manual.....	52
Menu.....	405
Control permission.....	201
Enable.....	69
File formats	89, 90
Indicator	18
Jobs.....	238
Key menu.....	402

Archive (Cont.)

Local.....	52
Media % full	92
Remote	54
To media.....	87
To remote.....	88
with lockable flap.....	53
Archive failed instrument alarm.....	16
ASCII	
Codes.....	398
Input.....	149
Printer	338
Configuration menu	407
Specification	384
At version.....	229
Audible warnings	249
Audit trail.....	25
Demand write messages	177
Enable	205
Autoconfigure key.....	194
Auto detect page	157
Automatic archive	87, 88
A values.....	67
Average	
Rolling.....	118
Time	79

B

Background	
Colour.....	227, 263
Decimal.....	266
Quartile.....	266
Banner.....	183
Bargraph	
Channel	272
Group	
Horizontal.....	271
Vertical.....	271
Style.....	265
Bargraph display mode	
Horizontal.....	46
Vertical.....	44
Based on.....	208
Basic/Advanced selection	258
Batch	
As event source	107
Configuration	100
Menu.....	406
Control.....	23
Permission.....	201
Counter initiation	107
Enter data permission	202
Event sources.....	107
Field 1	182, 341
Fields.....	102
Initiation.....	107
Jobs.....	234
Message display.....	106
Message filter	25
Message log option.....	26
Modbus initiation.....	107
Mode.....	101

Batch (Cont.)

Number	102
Operator initiation	104
Running (Event source).....	91, 107
Start (Event source).....	91, 107
Start (Job).....	234
Stop (Event source).....	92, 107
Summary	22
Battery	
Backed RAM data.....	377
Diagnostics	389
Indicator	18
Low (Event source).....	92
Replacement.....	391
Specification	377
Battery-backed RAM cleared	16
Baud rate	
Selection.....	151
Serial comms.	340
Serial printer	347
Bell symbol.....	18
Best Fit Font	265
Binary	89
and CSV.....	86
Blue line across the chart.....	36
Bold	183
BootP Timeout.....	213
Break response.....	76
Bridge	
Alarm acknowledgement	250
Configuration	
Access menu	247
Options menu	246
Connection details	245
Minimum PC requirements	244
Operation.....	250
Running the program	248
Software installation.....	246
Start as Lite.....	248
Brightness control.....	63
Bring archive up to date.....	53
Jobs.....	238
BSpc	33
Button	
Number	94
Text.....	263
B values.....	67

C

Cable	
Diameter	
Power	9
Signal	5
Calibration coefficients.....	378
Can	
Authorize.....	201
Sign	201
Cancel Archive.....	52
Jobs.....	238
Caps	33
Card slot	11
Category.....	81, 93

C (Cont.)

Centralised Security	206
Change	
Alarm setpoints permission	200
Battery	
Procedure	391
Symbol.....	18
Maths constant permission	200
Password	209
Time and date.....	219
Time (Rate-of-change alarms).....	79
Change Password	197
Changes not recorded	203
Channel	
Alarms.....	266
Indicator.....	18
Sounds.....	249
Ave/Max/Min	111
Bargraph.....	272
Colour	77
Configuration	71, 404
32-bit data (MODBUS)	318
MODBUS.....	291
Copy.....	224, 225
Cycle time.....	265
Cycling enable/disable	36
Damping.....	76
Data.....	272
Descriptor	76
Error	16
Failure	16
Maths	108
Number	72, 160, 162
Numeric.....	272
Run-time data (Modbus)	303
IEEE (32-bit).....	322 to 374
Select	221, 372
Thresholds	266
User screen parameter.....	263
Value	72, 270
Virtual.....	195
Character set.....	33
Serial comms	398
Chart	
Full.....	67
Speed.....	42, 67
Circular	
Chart Full	67
Settings.....	67
Speed.....	67
Trend Mode	40
CJC.....	76
Remote CJC Block Unit.....	361
Cleaning	390
Clear	196, 236
Password Cache.....	197, 210
Clock	
Accuracy.....	377
Failure (instrument alarm).....	16
Jobs.....	233
Preset hours and minutes settings.....	64
Setting	219
Permission.....	200

C (Cont.)

Close key	257
Cold junction compensation (CJC).....	76
Remote CJC Block option	361
Colour	
Alarms.....	265
B.....	236
Group	236
Backgrounds.....	265
Backgrounds, Text etc.....	227
Channel	77, 266
Foregrounds.....	266
RGB definitions.....	395
Style.....	266
Thresholds	266
Trace.....	77
Colours and Fonts configuration menu.....	413
Communications	
Channel timeout.....	63, 91
Diagnostics	171, 223
Modbus master	171
Printer settings	347
Serial	149
Compact Flash location	11
Component	
Definitions.....	271
Info on screen.....	258
Compressibility factor.....	115, 116
Compression.....	86
Config	
Key.....	58 to 242
Revision	229
Number	111
Configuration.....	51
A/B switching.....	67, 76
Access.....	198
Alarm.....	71
Analogue outputs.....	172
Archive.....	85
ASCII printer	339
Audit pack	203
Batch	100
Break response.....	76
Channel	71
Clock.....	219
Cold junction compensation.....	76
Copy.....	224
Counter.....	143
Country.....	219
Date format	219
Decimal places	77
Demand Writes	174
Display brightness settings.....	63
DST.....	219
Email.....	178
Ethernet Diagnostics.....	223
Event	91
Buttons	94
Filter	76
Full (access permission)	201
Group.....	65
Input adjust	221
Input low/high	73

Configuration (Cont.)

Instrument.....	63
Language.....	219
Linearisation	
Range.....	73
Type.....	72
Locale.....	219
Locked icon.....	18
Management option.....	203
Master comms.....	153
Maths channels.....	108
Menu.....	404 to 409
Message.....	95
Network.....	213
Offset.....	73
Options.....	194 to 196
Output Channel	
Analogue outputs.....	173
Master comms.....	172
Printer comms parameters.....	346
Reports.....	182, 341
Scale.....	73
Security.....	197
Serial communications.....	150
Shunt value.....	73
Span.....	77
Summertime.....	219
System.....	217
Time and date.....	219
Timers.....	147
Time zone.....	219
Totaliser.....	138
Trace colour.....	77
Upgrade.....	220
User linearisation tables.....	98
Views.....	82
Zone	
Area of chart.....	77
Time.....	219, 399
Connected messaging.....	184
Connect from Remote permission.....	199
Connections.....	149
Connector locations	
Large frame units.....	6
Small frame units.....	5
Constant.....	109
Contents of group.....	70
Continuous batches.....	101
Controller parameters.....	162
Copy.....	110, 224
Facility.....	224, 413
File.....	240
Key.....	256
Maths function.....	110
Rules.....	225
Screen.....	257
To/From.....	225
Counter	
Batch initiation.....	107
Configuration.....	143
Data (Modbus).....	144
IEEE 32-bit.....	145

Counter (Cont.)

Configuration menu.....	406
Copy.....	225
Enable.....	143
Jobs.....	233
Modbus addressing	
Configuration.....	144
IEEE (32-bit).....	146
Runtime data.....	145
Number.....	143
Preset permission.....	200
Country, Selection of.....	219
Created on.....	229
Creating a user screen.....	254
CSV.....	86
Date/time format.....	90
Files.....	89
Format.....	89
Use tab delimiter.....	89
Currently.....	194
Cursor keys.....	28
Custom Faceplate style.....	267
Customise.....	227
Configuration menu.....	413
Cut file.....	240
Cutoff (High/Low).....	138
Cycle channels on/off.....	36
D	
Daily.....	87, 88
Data	
Bits	
Printer.....	347
Serial Comms.....	151
Compression Ratio.....	86
Encoding (MODBUS).....	281
Entry Background colour.....	227
Source.....	173
Transmission (MODBUS).....	328
Type.....	164, 281
Demand writes.....	176
Date and time.....	341
Configuration.....	219, 412
CSV format.....	90
Reports configuration.....	182
Daylight saving configuration.....	219
DC supply	
Printer wiring.....	338
Recorder wiring.....	9
Decimal.....	187
Places.....	77, 177, 266
EtherNet/IP.....	187
Scale.....	269
Decrement counter.....	233
Default.....	172
Demand Write value.....	175
Gateway.....	214
Passwords.....	31
Default Table.....	185
Delete key	
File.....	240
User Screens.....	256

D (Cont.)

Demand	
Type.....	175
Writes.....	174
Action permission	202
Button.....	175
Configuration menu	408
Copy	225
Jobs	237
To specific register	176
With Audit Trail.....	177
Deploy.....	257
Descriptor	
Channel	76
Demand write	175
Email Recipient list.....	179
Event	93
Event Button	94
Font	267
Group.....	15, 66
Group minimum maths function.....	132
Instrument.....	63
Minimum Channel.....	132
Output channel	172, 173
Report.....	182, 341
Slave device	155
Timer.....	148
User Linearisation table	98
Detect	
All slaves	156
This slave	155
Deviation	
Alarm type.....	78
Value	79
DHCP Server failure	16
Diagnostics	
Display.....	385
Ethernet.....	223
Master comms	171
Summary	388
Dialogue action	272
Digital.....	160, 162
Disable	
Alarms.....	238
Counter.....	233
Display	
Alarms.....	267
Descriptor	267
Messages	267
Pens.....	267
Units.....	267
Group counters	233
Group totalisers.....	231
Login	200
Maths Function.....	232
Retries	175
Timer job	234
Totaliser	231
Warning dialogs.....	64
Disabled Text colour.....	227
Discard.....	156
Ethernet IP Table	185
Key.....	257

D (Cont.)

Disk	
Size.....	87
Symbol.....	18
Display	
Alarms.....	267
Bargraph.....	267
Batch Dialogue.....	107
Brightness	63
Calibration	386
Colour configuration menu	413
Descriptor	267
Enable (group).....	83
Home	82
Messages	267
Modes.....	35
Circular trend	40
Enable.....	83
Home	82
Horizontal bargraph.....	46
Horizontal trend	38
Numeric.....	48
Select.....	28
Vertical bargraph.....	44
Vertical trend.....	36
Pens.....	267
Test.....	386
Units	267
Update rate	377
Values (truncation of)	14
Dispose.....	257
Divide	109
DNS	216
Domain name	
Access menu.....	199
Domain Name Service.....	216
Do Not Remove Archive Media.....	13
Draw	
Edge.....	263
Order	263
Drive Relay job.....	231
Dry bulb temperature.....	127
Dryness.....	120
DST	219
D-type connector wiring.....	9
Duration.....	148
Dwell	79

E

Earlier messages.....	26
Edit	
Level.....	258
Maths constant permission	200
Output channel default.....	201
Own password permission.....	200
Parameter	263
EIA232 / EIA485 selection	151
Elapsed time format.....	112
Electrical installation.....	5
Email	
Access.....	181
Appearance	180

Email (Cont.)

Configuration	178
Menu	409
Failure	92
Generation	180, 181
Jobs	239
Messages	181
Number	179
Emphasised	183
Enable	
Alarm	78
Audit trail	205
Batch	101
Counter	143
Demand writes	175
Display	
Alarms	267
Descriptor	267
Messages	267
Modes	83
Pens	267
Units	267
Error code B	152
EUOPRP Server	215
Modbus Slave	155
Options	394
Output channel	172, 173
Recording	235
Remote device	155
SNTP Server	214
Talk through	152
Timer	148
Totaliser	138
End of message characters	151
Engineer, Access level	31, 198
Enter batch data (permission)	202
Enter history	35
Message log option	26
Erase all history	196
Job	235
Option	400
Error	
Code B enable	152
Messages	
Bridge	251
User screens	279
Errors To (Email configuration)	179
EtherNet	
Address	388
Diagnostics	223, 412
LED interpretation	378
Modbus Slave	155
EtherNet/IP	184
Client	224
Comms Input	109
e to the power	111
EUOPRP Server enable	215
Event	
As event source	91
Button	263
As event sources	92
Configuration	94, 405
Size, shape etc	273

Event (Cont.)

Configuration	91, 405
Copy	225
Input board	
Specification	384
Wiring	8
Inputs	334
As event sources	92
Number	91
Permissions 1 to 5	201
Source	91
Batch	107
Source sense	92 to 93
Exclamation mark symbol	16
Exit	372
Explicit messaging	184, 224
Export	
Ethernet table	185
Key	257
Screen	56
User linearisation	57
User screens	253
External CJ	76
F	
Faceplates	42
Location	267
Style	267
Failed to authenticate user name	251
Fast Settle	221, 222, 372, 373
Feature	263
Changed	243
Identification table	315
Locked	243
Fields 1 to 6	
Batch	102
Type	
Reports	182
Serial comms	341
File	240
Delete	240
Format	87
Media	89
Key	28
Name character limitation	56
Paste/delete permission	201
Structure	242
Transfer (FTP) facility	54
Filer option menu keys	240
Fill Area	263
Filter	76
First	
Channel (Input adjust)	221
Start/End character	151
Switch on	31
First channel	372
FIT	315
Fixed Text colour	227
Flap, lockable	12
Unlock permission	201
Flash size	86
Flow	120

F (Cont.)

Folder keys	28
Font	
Set.....	227
Style.....	267
Force change of password	202
Foreground	
Colour.....	227, 264
Decimal.....	266
Quartile.....	266
Format	
PV.....	77, 112
User Lin. point pairs.....	98
For (nodes)	156
Freeze.....	236
From	
Node	156
Point	68
From point.....	187
FTP	
Error messages.....	16
File format	87, 90
Icon.....	18
Transfer.....	54
Full	
Configuration access.....	201
Detail.....	23
Details (Message log).....	26
Screen (circular trends)	42
Security.....	201
User name	208
Function code.....	164, 176
03.....	329
04.....	330
06.....	330
08.....	330
16.....	331
Fuse (Transmitter power supply)	335, 378
FValue maths function.....	113

G

Gas constant	114, 116
General message filter	25
Global	
Channel alarm	415
Global alarm	
Event source	91
Unacknowledged.....	91
Goto	
Canvas	257
Group.....	29
View.....	28
Green line across the chart.....	36
Grid	
Line colour	
Major.....	267
Minor.....	268
Type.....	68

Group (Cont.)

Group	
Adding points to	70
Average/Minimum/Maximum.....	109
Configuration	65, 404
Copy.....	225
Data (MODBUS).....	309
Descriptor	15, 66
Display Mode enable	83
Home	82
Horizontal Bargraph	271
Latched Maximum maths function.....	110
Latched Minimum maths function.....	110
Minimum.....	132
MKT maths function	124
Number	66, 160, 175, 264
Numeric display	272
Recording enable/disable	68
Report destination.....	239
Selection for comms messages.....	151
Trend	271
Vertical bargraph	271
Views, Scope.....	83

H

Handshake.....	347
Hardware version	229
Height.....	264
Hide key	240
High	
Cutoff.....	138
Point.....	222
Priority interval	154
Select	110
Highlight.....	23
High/Low	177
High Point.....	373
History.....	418
Amount of	35, 69
Background/Foreground colours	227
Home	
Group.....	82
Key.....	28
Page	83
Timeout.....	82
Horizontal	
Alignment.....	267
Bargraph.....	46, 269
Faceplate.....	267, 269
Grid total	267
Minor Divisions.....	268
Trend display mode.....	38
Enable.....	83
User screens	271
Trend mode	
Web server.....	416
Host	223
Hourly.....	87, 88
HTM2010 Quarterly Test kit.....	353
Hysteresis	79

I		J	
Identifier	264	Jobs.....	231
Image	273	Active while/on.....	81
File.....	264	Alarm.....	238
Implicit I/O messaging	184, 224	Archive.....	238
Import		Batch	234
An image	273	Category	81
Ethernet table.....	185	Clock.....	233
Key.....	257	Counter.....	233
Printer driver.....	57, 343	Data	
Screen.....	56, 253	Include in copy.....	225
User linearisation	57	Demand Writes	237
In alarm or error.....	270	Drive relay	231
Include		Email.....	239
Alarm data.....	225	Maths	232
Job data.....	225	Message	232
Message	179	Number	81, 93
Increment counter.....	233	Output	237
Indirection tables (Modbus)	315	Recording.....	235
Input		Report.....	239
Adjust.....	221	Search.....	226, 413
Configuration menu	412	Timer.....	234
Board pinout.....	7	Totaliser	231
Board specification.....	379	Trend	236
Low/high.....	73	Just value.....	267
Type.....	72		
Input 1 to 200.....	185	K	
Installation		K.....	114
Category	375	Key	
Electrical.....	5	Code	220
Mechanical.....	2	File.....	220
Large frame unit.....	4	Functions.....	28
Small frame unit	3		
Inst cal corr n.....	134	L	
Inst calibration points.....	134	Label symbols.....	1
Inst cal temp n.....	134	Language.....	219
Instrument		Last	
Alarms.....	16	Channel	221
As event sources.....	92	Error	264
Message disable.....	64	Updated	229
Summary	19	Last channel	372
Symbol (Exclamation mark).....	16	Latched	78
Configuration	63	Text.....	94
Menu.....	404	Later messages.....	26
Data (Modbus).....	290	LED INDICATORS.....	11
Name.....	63	Left arrow key.....	28
Number	213, 220	Line	277
Variant.....	229	Across the chart	36
Insufficient non-volatile memory.....	16	Feed	182, 183, 341, 342
Internal CJ	76	Thickness.....	268
Internal flash error messages	16	Wiring	9
Interval B.....	236	Linear	
Invalid		Chart grid	68
Multiple register writes	281	Mass flow.....	114
Password entry.....	92	Scales.....	74
Selection.....	70	Linearisation	
Invalid item (EtherNet IP)	186	Function (LIN Type).....	72
I/O Table	185	Function (User entered).....	98
IP Address	155, 214	Link error count	151, 339
Lookup.....	213	List of operators	270
Manual entry.....	214		

L (Cont.)

Local	
Archive.....	52
Host.....	216
Modbus Client.....	223
Locale.....	219, 412
Lockable flap.....	12
Locked icon.....	18
Log	
Base 10.....	111
Base e.....	111
Chart grid.....	68
Scale.....	74
Logged out.....	31
Login.....	25, 32, 410
By User List.....	207
Disabled.....	200
Required.....	155
Timeout.....	204
Log/Linear.....	74
Logout key.....	197
Long	
Date format.....	219
Messages.....	286
Loop Number.....	162, 172, 175
Low	
Cutoff.....	138
Point.....	222
Priority interval.....	154
Select.....	110
Low Point.....	373

M

MAC Address.....	213, 388
Mail Server.....	179
Mains wiring.....	9
Maintenance.....	390
Schedule.....	391
Major/minor circular chart divisions.....	67
Management	
Configuration menu.....	410
Option.....	203
Manual Archive	
Local.....	52
Remote host.....	54
Mass flow	
Linear.....	114
Saturated Steam.....	120
Square root.....	116
Master Comms.....	153
Configuration menu.....	408
Diagnostics.....	223
Example configuration.....	167
Maths function.....	111
Slave Failure event source.....	92
Maths	
Channel	
Copy.....	225
Failure.....	16
Partial failure.....	92

Maths (Cont.)

Channel (cont.)	
Run-time data (Modbus).....	136
IEEE 32-bit.....	137
Configuration.....	108, 406
Modbus data.....	135
IEEE 32-bit.....	136
Function	
10 to the power.....	110
Add.....	109
Channel Ave/Max/Min.....	111
Config Revision Number.....	111
Constant.....	109
Copy.....	110
Disable.....	232
Divide.....	109
Edit constant permission.....	200
Ethernet/IP Comms Input.....	109
e to the power.....	111
FValue.....	113
Group	
Average.....	109
Latched Maximum.....	110
Latched Minimum.....	110
Maximum.....	109
Minimum.....	109, 132
High Select.....	110
Log Base 10.....	111
Log Base e.....	111
Low Select.....	110
Master comms.....	111
MKT.....	118
Group.....	124
Modbus Comms Input.....	109
Modulus.....	111
Multiply.....	109
O2 correction.....	126
Polynomial.....	112
Rate of change.....	125
Relative Humidity.....	127
Reset.....	232
Reset permission.....	200
Sample and Hold.....	110
Sample and Hold trigger.....	232
Saturated steam	
Heat consumed.....	123
Heat Flow.....	122
Mass flow.....	120
Security Revision Number.....	111
Square Root.....	110
Stopwatch.....	109
Subtract.....	109
Switch.....	110
Switch to B job.....	232
Timestamp.....	111
Zirconia probe.....	128
Jobs.....	232
Number.....	108

M (Cont.)

Maximum	
Block size	155
Decimal digits	77
Number of Bridge	251
Number of data bytes	280
Max/Min (adaptive recording)	66
Mean kinetic temperature (MKT)	118
Measured	
Gas	126
Oxygen	126
Measuring units	279
Mechanical installation	2
Large frame unit	4
Small frame unit	3
Media	86
Archiving error messages	16
File format	87, 89
Full	53
Event limit	87
Location	11
Removal	12
Size	87
Medium Priority interval	154
Memory device location	11
Memory size	86
Menu structure	
Archive key	402
Config menu	404 to 409
Network key menu	411
Root menu	401
Save/Restore key	403
Security key	410
System key	412
Message	182, 341
Alarm	81
Auditor, Batch	100
Bar	42
Batch, Initiation	103
Colour	268
Configuration	95, 405
Copy	225
Display (batch)	106
Enable/disable	69
Entry	95
Example	97
Inclusion in reports	182
Jobs	232
Log	24
Number	95
Operator entered	50
Power up	31
Serial comms	149
Start/End characters	151
Text	95
To print	340
Messages	
Log	417
Messaging	
Information	152
Rules	152

M (Cont.)

Minimum	
Channel Descriptor	132
Height	268
Password length	204
PC requirements	244
Width	268
Min-max recording	66
Missing pixels test	386
MKT maths function	118
Group	124
Modbus	
Address	155, 156
Setting	63
Address 255	152
Batch initiation	107
Comms Input	109
Master/Slave configuration menus	407
Maximum number of data bytes	280
RTU	149
Security	281
Enable/disable	63
Slave	
Enable	155
Online	155
Selection	154
Status	223
Wiring	280
Modulus	111
Monthly	87, 88
Mouse lock-up	378
Move Screen	257
Multiply	109
N	
Name files by Batch	103
NAND	93
Navigation	
Action	272
Keys	28
Network	
Address	213
Master comms	155
Boot failure	16
Configuration	213, 411
Connection has timed out	251
Ethernet/Serial selection	155
Key	411
Name	216
Scanning tool	215
Specification	378
Never	270
New	56, 257
Chart	67
Configuration	56
Domain name	208
File	240
Full user name	208
Key (File)	240
Password	199, 208
User ID	208
User Screen key	256, 257

N (Cont.)

No	
Action.....	231
Alarms.....	267
Chart grid.....	68
Nominal height/width	268
None.....	68, 74, 87, 88, 177
NOR.....	93
Normal	
Print style.....	183
View (circular charts).....	41
Normal/Saver display	63
Notes.....	50, 268
Message log option.....	26
No Text.....	269
Not in alarm or error	270
Number	
Of batch messages.....	102
Of columns.....	268
Of Fields	182, 341
Of points.....	99
Of rows	268
Numeric	
Display mode.....	48
Enable.....	83
Web server.....	417
PV format.....	77, 112
Width	268
N Value.....	264

O

O2	
Concentration.....	128
Correction.....	126
Potential.....	130
Off.....	78, 91
Offset	73, 173
Correction (touch screen).....	386
OK to remove archive media.....	12
On	
Becoming active/inactive etc.....	231
Error	173
Write Default	172, 175
Job active.....	81, 93
Media full.....	87
New clear.....	102
Start/stop log.....	102
Visibility change	268
Online (Modbus slave).....	155
Open/Closed strings	165
Operator	
Access level.....	31
Button	273
Event logic.....	93
Key.....	28
Notes.....	50
Options	194 to 196
Board pinout.....	8
Display	409
Key.....	28
OR.....	93

O (Cont.)

Out of Range.....	186
Output	
Adjust.....	332
Channel	
Configuration	
Analogue outputs	173
Master comms	172
Menu.....	408
Edit default permission.....	201
Number	172, 173
Range High/Low	173
Copy.....	225
Jobs.....	237
Type.....	172, 173
Output 1 to 200	185
Oval	277
Overwrite.....	87
Existing slaves	156
Ovr.....	33
Oxygen	
Concentration.....	128
Correction.....	126
Potential.....	130

P

Page	
Name.....	15
Title	264
Up/down keys.....	28
Paint	
All.....	268
Background.....	268
Paper Low/Out instrument alarm	17
Paper Low/Paper Out	17
Parameter	160, 162, 172, 175
Parity	151
Serial comms	340
Serial printer	347
Password	
Attempts	204
Authentication.....	210
Cache.....	210
Expiry.....	215
Change	209
Change on Expiry	206
Default (=100)	31, 32
Editing.....	199
Edit own, permission	200
Expire.....	204
Expiry time	200
Force change.....	202
Master comms	155
Minimum length.....	204
New/Retype	199
Remote	199
Paste	
File.....	240
Key.....	256
Paste/Delete files permission.....	201
Perform upgrades.....	201

P (Cont.)

Period	
Filter	25
Scaler	139
Permanent ID table	328
Ping Status/Ping Now	223
Pixels (Absolute/relative).....	254
Point.....	183, 342
Alarm.....	91
Number	160, 172
Status	187
Type.....	172, 175, 187
Selection	70, 160
Pollution degree.....	375
Polygon.....	276
Polyline.....	275
Polynomial maths function	112
Port	
Numbers.....	397
Selection (serial communications).....	151
SMTP	179
Portable case	
Basic option	349
Basic option with TRS	351
Dimensions	348
HTM2010 Test kit.....	353
Low supply voltage.....	358
Remote CJ Block option	359
Remote CJC Block option	359
Thermocouple option	355
Positioning	
Grid	258
Tip.....	258
Power requirements	377
Power up	
Event source	92
Messages	31
Filter.....	25
Preset	
Clock job	233
Counter.....	143, 233
Permission.....	200
Group counters	233
Group totalisers.....	231
Hour/Minute.....	64
Now	138
Totaliser	138, 231
Permission.....	200
Pressure	120
Unit conversion	121
Preventive maintenance	390
Primary	
DNS server	216
Login name/password.....	88
Primary/Secondary remote host.....	88
Printed keys	28
Printer	
Driver, importing new	343
Name.....	340
Not responding.....	17
Status	340
Supply Wiring	338
Switch settings.....	347

Printer (Cont.)

Test.....	340
Type.....	340
Print Messages From	340
Priority intervals.....	154
Process Value.....	160, 162, 172, 182, 187, 341
Profile	155
Properties page (User screens).....	256
Protocol.....	151, 340
Email.....	179
Psychrometric constant.....	127
PV.....	160, 162, 172, 182, 341
Format	77, 112
Q	
Question mark	14, 152
Question marks in message	95
Quick entry to user screen edit.....	258
R	
Range	
Low/High	173
Units	73
Rate of change	
Alarms.....	78
Maths function.....	125
Rcpt1 to Rcpt10.....	179
Reading	
Digital values	165
User defined registers.....	163
Recall mode	196
Recipient List.....	179
Recorder	
Configuration	58
Dimensions	3 to 4
Electrical installation	5 to 8
Panel installation	2 to 4
Specification	376
Unpacking.....	2
Wiring	5 to 8
Recording	
Enable/disable.....	68
Failure instrument alarm	17, 206
Jobs.....	235
Speed B job	235
Speed / interval.....	69
Record logins.....	204
Rectangle	274
Round.....	274
Red	
Bell symbol.....	18
Line across the chart.....	36
Reference	79
Refresh	26
File.....	240
Register.....	164
Demand write destination.....	176
Relative Humidity	127
Relay	
Board specification.....	383
Jobs.....	231
Wiring	8

R (Cont.)

Remaining.....	148
Remote	
Archiving (FTP transfer).....	54
CJ block option	
Portable case.....	359
CJC block option.....	361
Cold junction compensation.....	76
Modbus Client.....	223
Password.....	199
Path.....	88
User name.....	199
Removable media	
Capacity.....	87
Error messages (instrument alarms).....	17
Remove	
Adjust.....	221
Media.....	28
User.....	209, 410
Repeat after/in.....	148
Replace {n} with.....	95
Reports.....	25, 341
Configuration.....	182, 341
Menu.....	409
Destination.....	239
Example.....	344
Jobs.....	239
Number.....	182
Selection.....	239
Require	
Authorization.....	94, 205
Signing.....	94, 204
Re-scan.....	156
Reset	
Maths Function.....	232
Permission.....	200
Now.....	148
Timer	
Job.....	234
Permission.....	200
Restore.....	56
Retransmission.....	173
Retry.....	155
Time.....	179
Retype password.....	199, 208
Reversed colour.....	268
Revert.....	257
Revision numbers.....	229
RFC2822.....	180
RH.....	127
Right arrow key.....	28
Rolling average.....	118
Root mass flow.....	116
Root menu	
Keys.....	28
Overview.....	401
Rotate chart.....	40, 67
Round Rectangle.....	274
RTD input specification.....	380

S

Safety notes.....	1
Sales Demo Enable/Disable.....	386
Sample and Hold.....	110
Sample rates.....	377
Saturated steam	
Heat consumed.....	123
Heat flow.....	122
Mass flow.....	120
Save.....	56, 257
After.....	63
As.....	56
Saver Display	
Configuration.....	63
Job.....	236
Save/Restore	
Key.....	55
Menu.....	403
Permission.....	201
Scale	
Circular chart.....	42
Divisions.....	74
Divisions (Major/Minor).....	268
Low/high.....	143
Maths functions.....	111
Low/high/units.....	73
Style.....	269
Type.....	74
Scaled.....	73
Scale Low/High	
Totaliser.....	139
Scaling.....	160, 164, 172, 177
Factor.....	114, 116
Scientific PV format.....	77, 112
Scope.....	82, 101
Screen	
Brightness.....	63
Builder option.....	252. See also User Screens
Calibration.....	386
Import/Export.....	56
Number.....	264
Saver.....	63
Size.....	279
SD card location.....	11
Secondary	
Login/Password/Remote Host.....	88
Secondary DNS server.....	216
Second Start/End character.....	151
Security	
Full, access permission.....	201
Key.....	197, 410
Levels.....	198
Modbus.....	281
Revision Number.....	230
Maths function.....	111
Select	
Channels.....	221, 372
Display mode.....	28
Group.....	29
Point Type.....	70
Selected item colour.....	227
Self Start.....	148

S (Cont.)

Send	
On Power Up.....	175
Report to	239
Sender.....	179
Serial 1/Serial 2.....	389
Serial communications.....	149
Configuration	407
Message information.....	152
Pinout.....	9
Port selection.....	151
ASCII printer	339
Specification	378
Standard (EIA232 or EIA485)	151
Set clock permission.....	200
Setpoint source	78
Setting the time and date	219
Share Socket	155
Shift	33
Shortest trend history/duration	86
Show	
Batch entry list.....	101
Disk (local) settings.....	86
Operator notes list.....	64
Title Bar.....	264
Show Errors key	185
Shunt	73
Signal wiring.....	5
Remote CJC block	
Large frame	361, 364
Small frame	368
Signings	25
Simulation option	196
Single line Faceplate.....	267
Slave	154, 160, 162, 172, 175
Slave detection.....	156
SMTP	179
SMS.....	179
SNTP	
Client enable.....	214
Server.....	214
Enable.....	214
Server failure instrument alarm	17
Socket, share.....	158
Software version.....	229
Sort.....	23
Source	
Demand write	175
Descriptor/value/alarm data	95
Files From.....	220
Output channel	172
Span high/low.....	173
Type	
Copy	225
Event.....	91
Source 1 sense.....	92
Source 2 sense.....	93
Spam	180
Span.....	160, 162
Span B	
Configuration	77
Jobs.....	236

S (Cont.)

Span High/Low	
EtherNet/IP	187
Spanned.....	77
Special modes	386
Specification	
Analogue output board	384
ASCII Printer.....	384
Back-up battery.....	377
Event input board	384
Input board	379
Pressure transducer.....	354
Previous instruments.....	382
Recorder, general	376
Relay output board.....	383
RTC.....	377
Serial comms board.....	378
Transmitter Power Supply.....	378
USB ports	378
Specific gas constant.....	114, 116
Specified descriptor/value/alarm	96
Specified O	126
Speed/Interval B.....	235, 236
Speed of recording.....	69
Square Root.....	110
'S' symbol	386
Start	
and End characters.....	151
and stop batches.....	101
Angle.....	264
as Lite	248
At	67
New Table.....	187
Now	148
Slave detection.....	156
Timer	
Job	234
Permission.....	200
Start of message characters.....	151
Status	
Bar	15
Demand write	175
Ethernet IP.....	185
Stop	
Bits.....	151, 340
On media full	87
Stopwatch.....	109
Store Diagnostics	154
Style.....	183, 342
Stylus location.....	11
Subject.....	179
Subnet mask.....	214
Subtract	109
Summary	
Menu	19
Page	
Alarm	20
Batch.....	22
Summertime configuration.....	219
Supply voltage	
Ranges	9, 377
Wiring	9

S (Cont.)

Support File.....	230
SupportInfo.uhq.....	230
Suspend Archive.....	53
Jobs.....	238
Switch.....	110
Printer, settings.....	347
to B maths function.....	232
Symbols used on labels.....	1
Synchronisation by SNTP.....	214
Syntax Error.....	186
System	
Alarms.....	16
Key.....	217
Menu.....	412
Message.....	25

T

Tag, Channel.....	76
Talk through enable.....	152
T/C cal corr n.....	134
T/C cal temp n.....	134
Temperature.....	120
Termination and biasing.....	149
Text.....	264, 341
Colour.....	227
Email body text.....	179
Entry techniques.....	33
Event button.....	94
Messages (Modbus).....	286
Report field type.....	182
Save and Restore.....	56
Size.....	227, 413
User screens.....	274
There appears to be no free disk space.....	243, 251
Thermal uniformity survey.....	100, 371
Thermocouple.....	134
Cal correction.....	134
Types and ranges.....	380
Type selection.....	72
Types J, K and T colours.....	356
Threshold.....	79
Indication.....	15
Time	
Marker	
Colour.....	269
Interval.....	269
To fill storage medium.....	87
Zone	
Details.....	399
Time and date	
Change indication.....	36
Configuration.....	412
Edit permission.....	200
Format.....	219
PV format.....	112
Setting.....	219
Synchronisation	
Hours and minutes settings.....	64
Recorder clocks.....	233
Synchronisation (SNTP).....	214

Time and date (Cont.)

Time synchronisation failure message.....	17
Zone.....	219
Timeout	
BootP.....	213
Comms channel.....	63
Event source.....	91
Home display.....	82
Login.....	204
Read/Write.....	155
Screen saver.....	63
Serial communications.....	151
Slave detection.....	156
Timer	
Active (Event source).....	91
Configuration.....	147, 406
Copy.....	225
Jobs.....	234
Number.....	148
Start/reset permission.....	200
Timestamp	
Circular charts.....	43
Maths function.....	111
Title Bar background colour.....	227
To point.....	187
Torque (wiring connectors).....	5
Totaliser	
Configuration.....	138, 406
Data (Modbus).....	140
IEEE 32-bit.....	141
Copy.....	225
Incorrect values.....	86, 139
Jobs.....	231
Modbus addressing.....	140
Number.....	138
Preset permission.....	200
Run-time Data (Modbus).....	141
IEEE 32-bit.....	142
Total of.....	138
Touch screen	
Calibration.....	386
Precautions.....	390
Transmitter Power Supply.....	335
Trend	
Foreground/Background colour selection.....	227
Freeze.....	196
History.....	35
Colour.....	227
Duration.....	69
Shortest.....	86
Horizontal.....	416
Jobs.....	236
Padding.....	269
Speed / Interval.....	67
Thickness.....	269
Type.....	66
Units.....	66
Vertical.....	417
Trial mode.....	195
Symbol (T).....	18
Trigger.....	78, 232

T (Cont.)

Truncation of values.....	14
'T' symbol.....	18, 195
TUS.....	100, 371
Type.....	78, 94

U

UCMM.....	184, 224
Unable to connect to host.....	251
Unable to resolve hostname.....	251
Unack'd	
Alarm on Group.....	92
Point alarm.....	91
Unconnected Message Manager.....	184, 224
Unconnected messaging.....	184
Unicode.....	89, 152
Units.....	254
Counter.....	143
Font.....	269
Input range.....	73
Pressure conversion.....	121
Scale.....	73
Scaler.....	139
Totaliser.....	138
Universal input board wiring.....	7
Unlatched.....	78
Unlock flap	
Key.....	28
Permission.....	201
Unpacking the recorder.....	2
Update when.....	269
Upgrade.....	220
Configuration menu.....	412
Initiation.....	220
Permission.....	201
USB	
Instrument alarms.....	17
Lock-up.....	378
Port location.....	11
Specification.....	378
Use	
Counter as batch number.....	102
Last properties.....	258
Temperature or pressure.....	120
Text for batch field 1.....	102
User	
Add and Remove.....	208
Defined	
Descriptor.....	132
Registers.....	163
Linearisation table.....	98
Configuration menu.....	405
Import/Export.....	57
Number.....	98
Units.....	73, 98
Logged In event source.....	92
Login account disabled.....	92
Name	
Full.....	208
Remote.....	199

User (Cont.)

Screens.....	84
Basic/Advanced selection.....	258
Component info on screens.....	258
Component list.....	255
Creation.....	254
Image Error.....	273
Importing/Exporting.....	253
Key descriptions.....	256, 257
Number of.....	84
Option.....	252
Parameters	
Advanced.....	265
Basic.....	263
Properties page.....	256
Quick entry.....	258
Username.....	155
Use Summertime.....	219

V

Value	
and Units	
Faceplate style.....	267
Changes.....	269
Channel.....	72
Counter.....	143
Font.....	269
Register.....	164
Totaliser.....	138
Vertical	
Alignment.....	269
Bargraph.....	44, 269
Display mode enable.....	83
Grid total.....	270
Minor Divisions.....	270
Trend.....	36, 271
Display mode enable.....	83
Trend display mode	
Web Server.....	417
Views	
Configuration.....	82
Menu.....	404
Virtual channels configuration.....	195, 409
Virus susceptibility.....	378
Visible	
Alarm.....	270
Channel.....	270
Operator.....	270
Value.....	270
W	
Web server.....	415
Enable.....	202
Weekly.....	87, 88
Wet bulb temperature.....	127
When visible.....	270
While [alarm] active, inactive, unacknowledged.....	81, 93, 231
Width.....	264
Wire size	
Signal.....	5
Supply.....	9

W (Cont.)

Wiring	
Analogue outputs.....	8
ASCII printer.....	338
D-type connector.....	9
Event inputs.....	8
Input board.....	7
Modbus.....	280
Option boards.....	8
Relay.....	8
Remote CJC block	
Large frame.....	361, 364
Small frame.....	368
Serial comms.....	9, 149
Signal.....	5
Supply (Mains).....	9
Transmitter Power Supply.....	337
Wire size	
Signal.....	5
Supply.....	9
with unapplied changes.....	204
Wizard (Ethernet IP)	
Ethernet IP.....	185
Worst case error calculation.....	381
Write	
Enable.....	175
Number.....	175
to a specific register.....	176

X

X1.....	98
Xon/Xoff.....	347
XOR.....	93
X points/position.....	264

Y

Y1.....	98
You are already running ... message.....	243, 251
You are authenticating Full Bridge... message.....	251
Y points/position.....	264

Z

Z-Factor.....	115
Zirconia probe.....	128
Zone	
B, select job.....	236
Chart area.....	77
Time	
Details.....	399
Selection.....	219
Z value.....	113

This page is deliberately left blank

Contact Information

Eurotherm Head Office
Faraday Close
Durrington
Worthing, West Sussex
BN13 3PL

Sales Enquiries
T +44 (0)1903 695888
F 0845 130 9936

General Enquiries
T +44 (0)1903 268500
F 0845 265982

Worldwide Offices
www.eurotherm.com/worldwide



Scan for local contacts

Represented by:

© Copyright Eurotherm Limited 2021

Eurotherm by Schneider Electric, the Eurotherm logo, Chessell, EurothermSuite, Mini8, Eycon, Eyris, EPower, EPack, nanodac, piccolo, versadac, optivis, Foxboro, and Wonderware are trademarks of Schneider Electric, its subsidiaries and affiliates. All other brands may be trademarks of their respective owners.

All rights are strictly reserved. No part of this document may be reproduced, modified or transmitted in any form by any means, neither may it be stored in a retrieval system other than for the purpose to act as an aid in operating the equipment to which the document relates, without the prior written permission of Eurotherm Limited.

Eurotherm Limited pursues a policy of continuous development and product improvement. The specifications in this document may therefore be changed without notice. The information in this document is given in good faith, but is intended for guidance only. Eurotherm Limited will accept no responsibility for any losses arising from errors in this document.