



2200e

# Engineering Handbook

2200e Series Controllers

HA029989/4  
February 2015





## 2200e Series Controllers

### Installation and Configuration Handbook

Models 2216e, 2208e and 2204e

#### Contents

<b>1</b>	<b>Installation</b> .....	<b>1-1</b>
<b>1.1</b>	<b>Instrument Layouts</b> .....	<b>1-1</b>
1.1.1	Outline Dimensions .....	1-2
1.1.2	Recommended minimum spacing of controllers .....	1-2
<b>1.2</b>	<b>Introduction</b> .....	<b>1-3</b>
1.2.1	Controller labels .....	1-3
<b>1.3</b>	<b>Mechanical Installation</b> .....	<b>1-3</b>
1.3.1	Unplugging and plugging-in the controller.....	1-3
<b>1.4</b>	<b>Wiring</b> .....	<b>1-4</b>
1.4.1	Wire Sizes .....	1-5
1.4.2	Sensor input connections .....	1-6
1.4.3	Outputs 1 and 2 connections.....	1-6
<b>1.5</b>	<b>PDS Modes</b> .....	<b>1-7</b>
<b>1.6</b>	<b>Snubbers</b> .....	<b>1-7</b>
<b>1.7</b>	<b>Typical single loop wiring diagram</b> .....	<b>1-7</b>
<b>1.8</b>	<b>Logic Drive Fan Out</b> .....	<b>1-8</b>
<b>1.9</b>	<b>EIA232/485/422 Communication connections</b> .....	<b>1-8</b>
1.9.1	Wiring of EIA-485 serial communication links.....	1-9
<b>1.10</b>	<b>DeviceNet® Wiring to Series 2200e Controllers</b> .....	<b>1-10</b>
1.10.1	DeviceNet Terminal Functions .....	1-10
1.10.2	Wiring Interconnections for DeviceNet Communications .....	1-10
<b>2</b>	<b>Operation</b> .....	<b>2-1</b>
<b>2.1</b>	<b>Front Panel Layout</b> .....	<b>2-1</b>
<b>2.2</b>	<b>Getting Started</b> .....	<b>2-3</b>
2.2.1	To View The Process Value and Setpoint .....	2-3
2.2.2	To Adjust The Setpoint.....	2-3
2.2.3	To View The Display Units.....	2-3
2.2.4	Use Of The "SCROLL" Button  .....	2-4
2.2.5	Use Of The 'PAGE' Button  .....	2-4
<b>2.3</b>	<b>Parameter Lists</b> .....	<b>2-5</b>
<b>2.4</b>	<b>Manual or Automatic Control</b> .....	<b>2-6</b>
2.4.1	To Select Auto/Manual Operation .....	2-6
2.4.2	To Manually Adjust Output Power.....	2-6
<b>2.5</b>	<b>Selecting SETPOINT 1 OR SETPOINT 2</b> .....	<b>2-7</b>
2.5.1	To Select Setpoint 1 orSetpoint 2.....	2-7
<b>2.6</b>	<b>Ramp Dwell Function</b> .....	<b>2-7</b>
2.6.1	To Set up a Ramp/Time Program.....	2-8
2.6.2	To Run the Program .....	2-8
2.6.3	Power Failure During Program Run.....	2-8
<b>2.7</b>	<b>Location of Parameters - Block Diagram</b> .....	<b>2-9</b>
<b>2.8</b>	<b>Navigation Diagram</b> .....	<b>2-10</b>
<b>2.9</b>	<b>Parameter Tables</b> .....	<b>2-11</b>
2.9.1	HOME Display.....	2-11
2.9.2	Alarm List.....	2-11
2.9.3	Autotune List.....	2-12
2.9.4	PID List.....	2-12
2.9.5	Setpoint List.....	2-12
2.9.6	Input List .....	2-13
2.9.7	On/Off List.....	2-13
2.9.8	Output List .....	2-13
2.9.9	Communications List.....	2-14
2.9.10	Access List .....	2-14
<b>2.10</b>	<b>Alarms</b> .....	<b>2-15</b>
2.10.1	Types of Alarm Used in the 2200.....	2-15
<b>2.11</b>	<b>Alarm Relay Output</b> .....	<b>2-16</b>
2.11.1	Setting Alarm Levels.....	2-16
2.11.2	Alarm Indication and Acknowledgement.....	2-17
2.11.3	Diagnostic Alarms .....	2-18

<b>3</b>	<b>Access Levels .....</b>	<b>3-1</b>
3.1	<b>The Different Access Levels .....</b>	<b>3-1</b>
3.2	<b>Selecting An Access Level.....</b>	<b>3-1</b>
3.2.1	Access list header .....	3-1
3.2.2	Password entry .....	3-1
3.2.3	Level Selection.....	3-2
3.2.4	Configuration password.....	3-2
3.2.5	Configuration level.....	3-2
3.2.6	To Return to Operator Level.....	3-2
3.3	<b>Edit Level .....</b>	<b>3-3</b>
3.3.1	To Set Operator Access to a Parameter .....	3-3
3.3.2	To Hide or Reveal a Complete List.....	3-3
3.3.3	To Promote a Parameter .....	3-3
<b>4</b>	<b>Tuning.....</b>	<b>4-1</b>
4.1	<b>What Is Tuning?.....</b>	<b>4-1</b>
4.2	<b>Automatic Tuning.....</b>	<b>4-1</b>
4.2.1	Heating and Cooling Output Cycle Times .....	4-1
4.3	<b>How To Tune .....</b>	<b>4-2</b>
4.3.1	Typical automatic tuning cycle .....	4-2
4.3.2	Calculation of the cutback values.....	4-2
4.4	<b>Manual Tuning .....</b>	<b>4-3</b>
4.4.1	Setting the cutback values .....	4-3
4.4.2	Integrating Action and Manual Reset .....	4-4
4.4.3	Automatic Droop Compensation (Adc) .....	4-4
<b>5</b>	<b>Configuration .....</b>	<b>5-1</b>
5.1	<b>To Select Configuration Level.....</b>	<b>5-1</b>
5.2	<b>To Select a Configuration Parameter.....</b>	<b>5-2</b>
5.3	<b>To Leave Configuration Level .....</b>	<b>5-2</b>
5.4	<b>Steps Involved In Configuring A Controller .....</b>	<b>5-2</b>
5.5	<b>Navigation Diagram (PART A).....</b>	<b>5-3</b>
5.6	<b>Configuration Parameter Tables.....</b>	<b>5-5</b>
5.6.1	Instrument Configuration.....	5-5
5.6.2	Input Configuration.....	5-6
5.6.3	Calibration Configuration.....	5-6
5.6.4	Alarm Configuration .....	5-7
5.6.5	Logic Inputs Configuration - 2208e and 2408e only.....	5-7
5.6.6	AA Alarm Relay Configuration - 2208e and 2408e only .....	5-8
5.6.7	Digital Communications Configuration .....	5-8
5.6.8	Output 1 Configuration .....	5-9
5.6.9	Output 2 Configuration .....	5-10
5.6.10	Output 3 Configuration .....	5-10
5.6.11	Output 4 Configuration .....	5-10
5.6.12	Password Configuration.....	5-10
5.6.13	Exit Configuration.....	5-10
5.7	<b>Configuration of Digital Communications .....</b>	<b>5-11</b>
5.7.1	To Configure the Function, and Baud Rate .....	5-11
5.7.2	To Set Instrument Address .....	5-11
5.8	<b>DeviceNet.....</b>	<b>5-12</b>
5.8.1	The EDS File.....	5-12
5.8.2	ODVA Compliance.....	5-12
<b>6</b>	<b>User Calibration.....</b>	<b>6-1</b>
6.1	<b>What is the Purpose of User Calibration? .....</b>	<b>6-1</b>
6.2	<b>User Calibration Enable .....</b>	<b>6-1</b>
6.2.1	The User calibration configuration List.....	6-1
6.3	<b>Single Point Calibration.....</b>	<b>6-2</b>
6.4	<b>Two Point Calibration.....</b>	<b>6-3</b>
6.5	<b>Calibration Points and Calibration Offsets.....</b>	<b>6-3</b>
<b>7</b>	<b>Alarm Configuration .....</b>	<b>7-1</b>
7.1	<b>Definition Of Alarms And Events .....</b>	<b>7-1</b>
7.1.1	Types of Alarms.....	7-1
7.2	<b>Digital Output Functions .....</b>	<b>7-2</b>
7.3	<b>Step1 - To Configure the Four 'Soft' Alarms .....</b>	<b>7-3</b>
7.4	<b>Step 2 - To Attach an Alarm to A Physical Output .....</b>	<b>7-4</b>

7.5	Step 3 - To Group Alarms on a Single Output .....	7-5
7.6	Step 4 - To Remove Alarms From An Output.....	7-5
<b>8</b>	<b>Motorised Valve Control.....</b>	<b>8-1</b>
8.1	Parameters For Motorised Valve Control .....	8-1
8.2	Commissioning the Motorised Valve Controller .....	8-1
8.2.1	Adjusting the minimum on-time <i>OnT<sub>H</sub></i> .....	8-1
8.3	Motorised Valve Applications .....	8-2
8.3.1	Auto Tuning.....	8-2
8.3.2	Valve Positioner Set-up Table .....	8-2
<b>9</b>	<b>Load Current Monitoring and Diagnostics .....</b>	<b>9-1</b>
9.1	Load Current Monitoring and Diagnostics.....	9-1
9.2	Example Wiring Diagram (For mode 1 & 2 operation) .....	9-2
9.3	Example Wiring Diagram (for mode 5 operation).....	9-3
9.4	Operation .....	9-4
9.4.1	To Read Load Current (modes 2 and 5 only).....	9-4
9.4.2	To Display Load Current Continuously in the Lower Readout (modes 2 and 5 only).....	9-4
9.4.3	Display Modes.....	9-4
9.4.4	How Heater Alarms Are Displayed.....	9-5
9.5	To Set The Alarm Trip Levels .....	9-5
9.6	Relay Outputs .....	9-6
9.7	To Configure PDS Load Current Diagnostics.....	9-6
9.7.1	To Configure the Logic Module for PDS modes 1 or 2.....	9-6
9.7.2	To configure Logic Input 1 for PDS (Mode 5 only) .....	9-7
9.8	To Configure Low and High Current Trip Alarms.....	9-7
9.9	To Attach Soft Alarms To A Relay Output.....	9-8
9.10	The Scaling Factor .....	9-9
9.10.1	To Adjust The Scaling Factor .....	9-9
<b>10</b>	<b>Retransmission.....</b>	<b>10-1</b>
10.1	What is retransmission.....	10-1
10.2	To Configure Retransmission .....	10-1
10.3	To Scale Retransmitted Output Signals .....	10-2
10.3.1	To Range Retransmitted Output <i>OP</i> .....	10-2
10.3.2	To Range Retransmitted Setpoint <i>SP</i> or Process Variable <i>PU</i> .....	10-2
10.3.3	To Range Retransmitted Error <i>Err</i> .....	10-2
<b>11</b>	<b>Understanding the Order Code .....</b>	<b>11-1</b>
<b>12</b>	<b>SAFETY and EMC Information .....</b>	<b>12-1</b>
12.1	Technical Specification .....	12-3
<b>13</b>	<b>Supplement 2208e Instruments .....</b>	<b>13-1</b>
<b>14</b>	<b>Index .....</b>	<b>14-3</b>


This product is covered by one or more of the following US Patents:  
5,484,206 and 5,793,754; Additional patents pending.

PDS® is a registered trademark of Eurotherm.

INSTANT ACCURACY™, SSRx Load Doctor™ and SSRx Enhanced Load Doctor™  
are trademarks of Eurotherm

## Symbols in Use In This Handbook

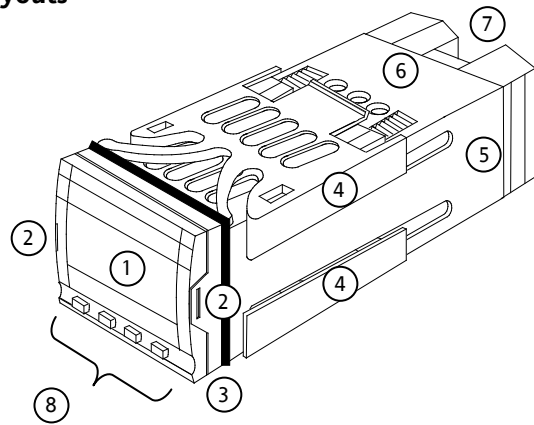
 Tip Useful information   Button Operation

 Caution, (refer to the  
accompanying documents)



# 1 Installation

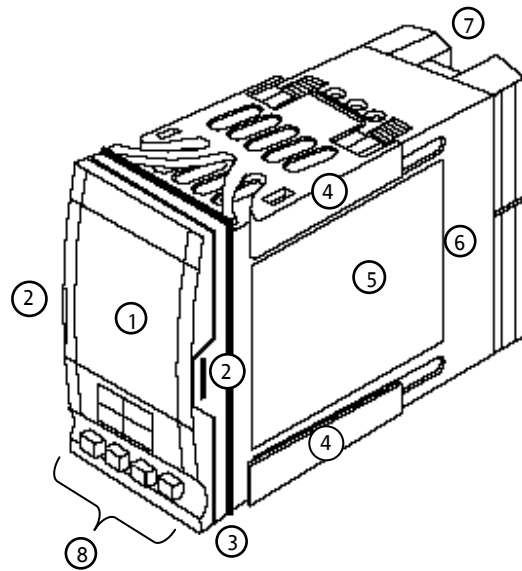
## 1.1 Instrument Layouts



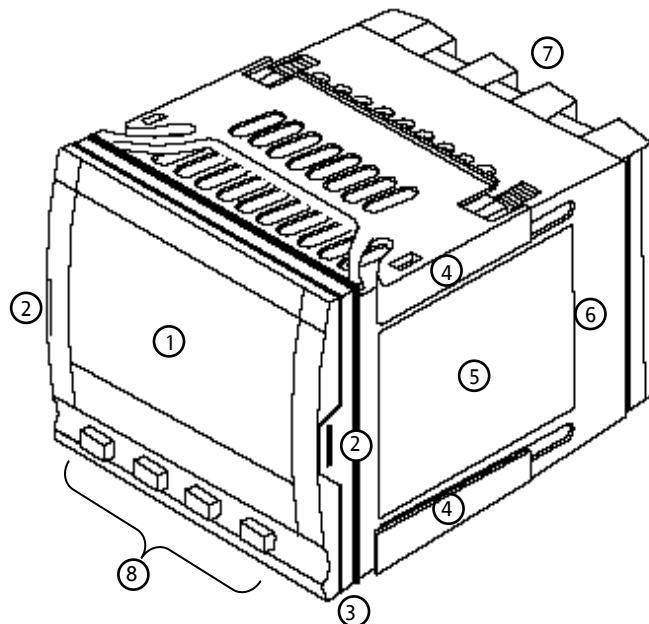
**KEY**

- 1. Display screen
- 2. Latching ears
- 3. Panel sealing gasket
- 4. Panel retaining clips
- 5. Label
- 6. Sleeve
- 7. Connection Terminals
- 8. Keypad

**Figure 1-1: 2216e 1/16 DIN Controller**

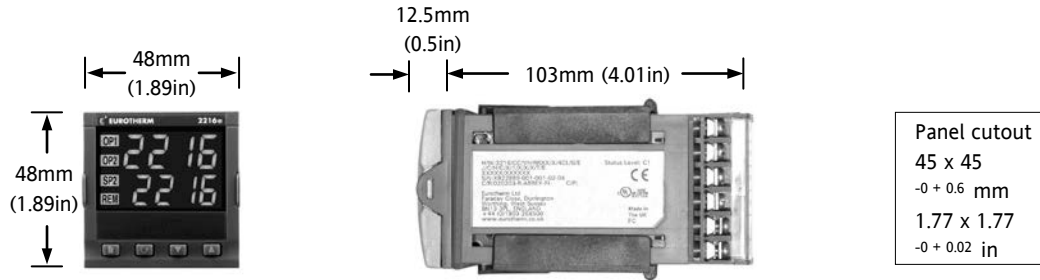


**Figure 1-2: 2208e 1/8 DIN Controller**

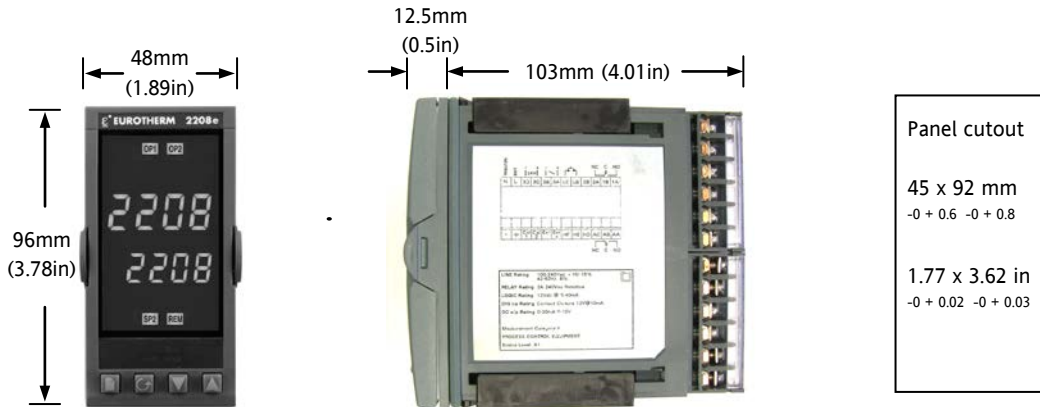


**Figure 1-3: 2204e 1/4 DIN Controller#**

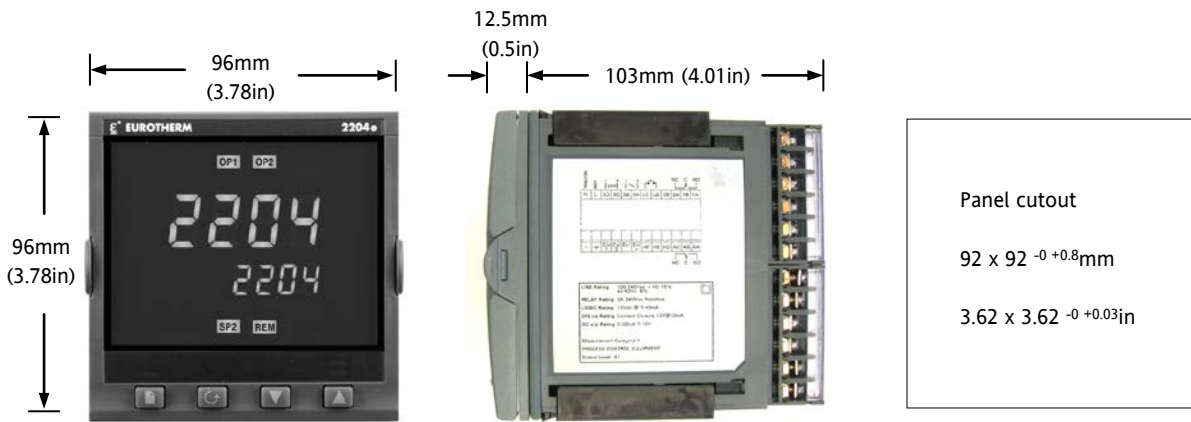
**1.1.1 Outline Dimensions**



**Figure 1-4: 2216e Controller**



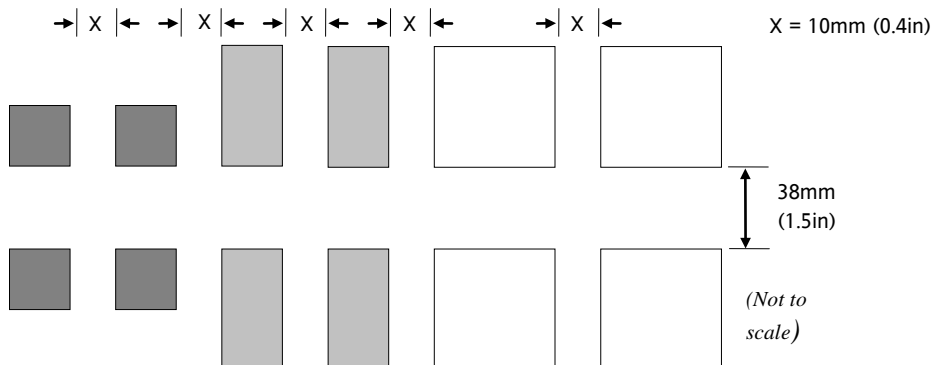
**Figure 1-5: 2208e Controller**



**Figure 1-6: 2204e Controller**

The controller plugs into a plastic sleeve, which in turn fits into the panel cut-out.

**1.1.2 Recommended minimum spacing of controllers**





## 1.2 Introduction

The Models 2216e, 2208e and 2204e are precision temperature controllers with self tuning. They have a modular hardware construction which provides two control outputs, alarm relays and one communications port. Two logic inputs are provided as standard in 2208e and 2204e.

### 1.2.1 Controller labels

The labels on the sides of the controller identify the ordering code, the serial number, and the wiring connections.

Section 11, *Understanding the Ordering Code* explains the hardware and software configuration of your particular controller.

## 1.3 Mechanical Installation

### To install the controller

1. Cut the panel to the relevant hole size shown in Section 1.1.1.
2. Fit the IP65 sealing gasket behind the front bezel of the controller.
3. Insert the controller in its sleeve through the cut-out.
4. Spring the upper and lower panel retaining clips into place. Secure the controller in position by holding it level and pushing both retaining clips forward.
5. Peel off the protective cover from the display.

Note: If the panel retaining clips subsequently need removing, they can be unhooked from the side with either your fingers or a screwdriver.

### 1.3.1 Unplugging and plugging-in the controller

The controller can be unplugged from its sleeve by easing the latching ears outwards and pulling it forward out of the sleeve. When plugging the controller back into its sleeve, ensure that the latching ears click into place to maintain moisture sealing protection.

### 1.4 Wiring

Please read Section 12, Safety and EMC information before proceeding.

#### WARNING



Please ensure that the controller is correctly configured for your application. Incorrect configuration could result in damage to the process being controlled, and/or personal injury. The controller may either have been configured when ordered, or may need configuring now. See Section 5, Configuration.

The wiring connections are shown below. Outputs are factory fitted modules which can be any one of the types shown in section 1.4.3. Check the ordering code on the controller side label to determine which have been fitted.

#### Model 2216e Connections

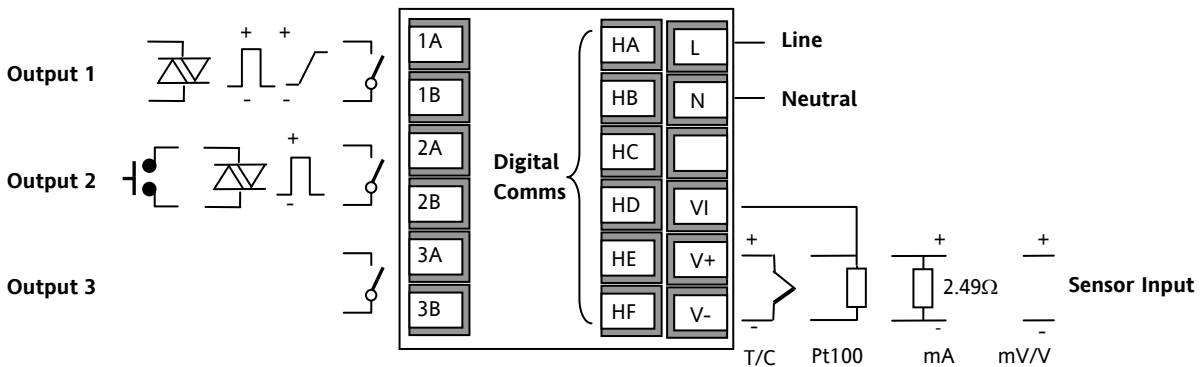


Figure 1-7: 2216e Terminals

#### Model 2208e Connections

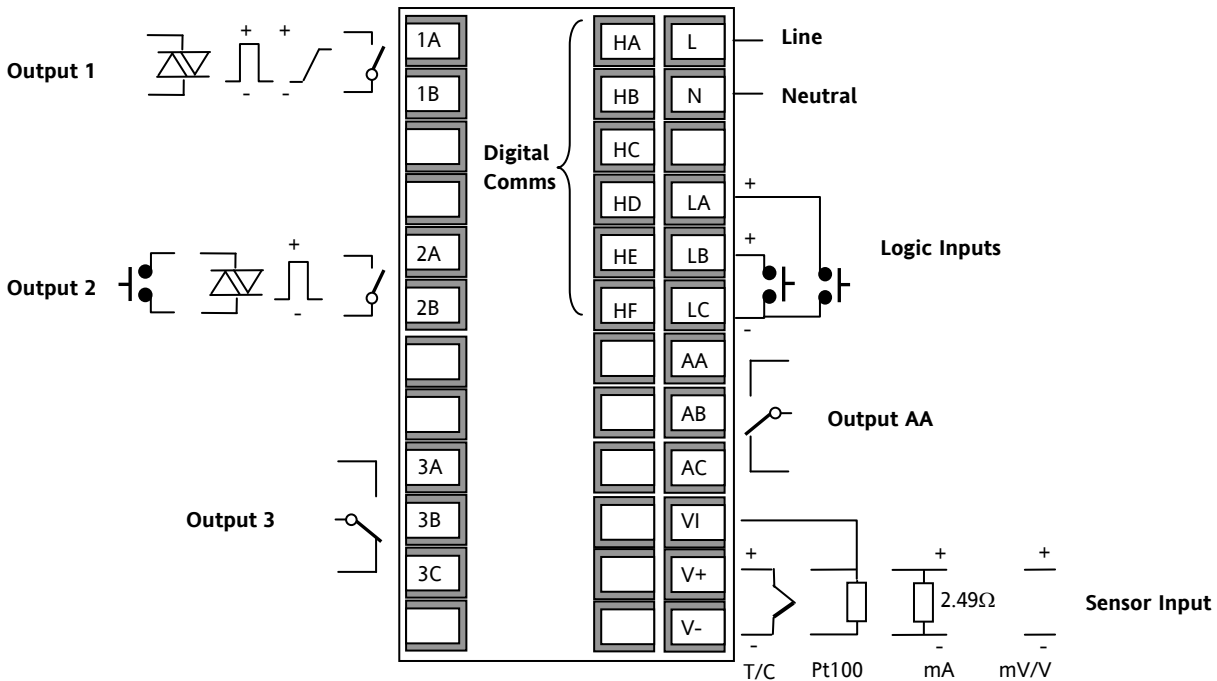
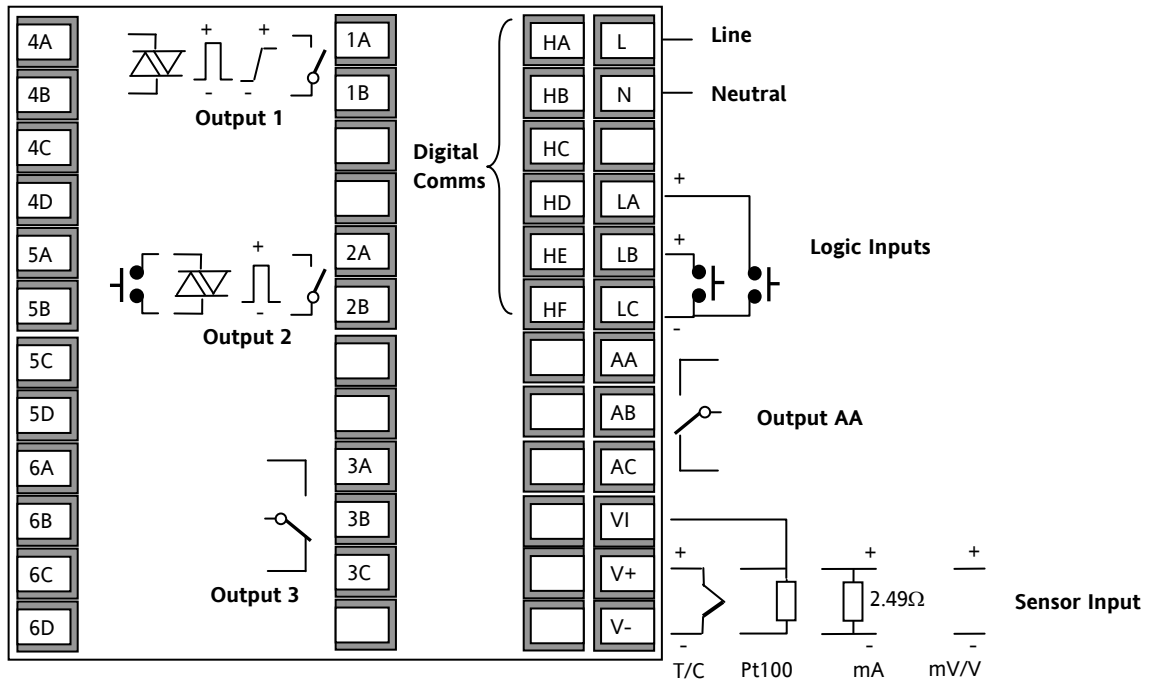


Figure 1-8: 2208e Terminals

**Do not use unused terminals as wire holders.**

**Model 2204e Connections**



**Figure 1-9: 2208e Terminals**

**Do not use unused terminals as wire holders.**

**1.4.1 Wire Sizes**

All electrical connections are made to the screw terminals at the rear of the controller. They accept wire sizes from 0.5 to 1.5 mm<sup>2</sup> (16 to 22 AWG), and are protected by a hinged cover to prevent hands or metal making accidental contact with live wires. Rear terminals should be tightened to a torque of 0.4Nm (3.5 lb in).

### 1.4.2 Sensor input connections

The connections for the various types of input are as follows:

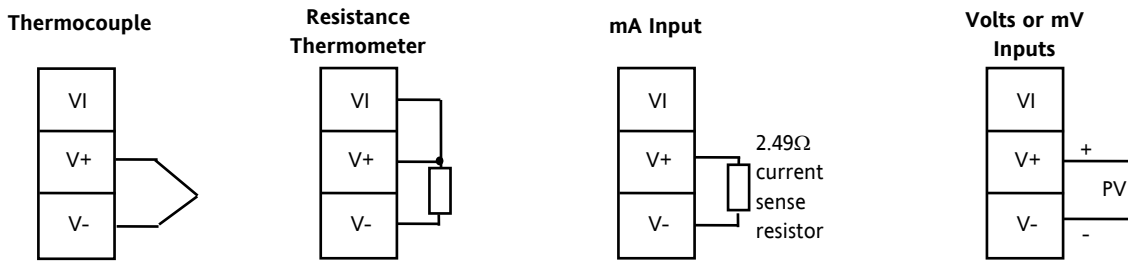


Figure 1-10: Sensor Input Connections



**Do not connect more than one sensor to any one input.**

### 1.4.3 Outputs 1 and 2 connections

Outputs 1 and 2 can be any one of the types shown in the table below, configured to perform any one of the functions shown.

To check which outputs are installed, and their configuration, refer to the ordering code and the wiring information on the controller side labels.

Module type	Connections				Possible functions
	Output 1		Output 2		
	1A	1B	2A	2B	
Relay: 2-pin (2A, 264 Vac max.)					Heating Cooling Alarms
Logic: non-isolated * (18Vdc at 24mA)					♦ PDS modes 1 or 2 (SSRx) Heating Cooling Alarms
Triac (1A, 30 to 264Vac)					Heating or cooling
DC control: isolated (18Vdc, 20mA max)			DC not available in output 2		PID Heating or cooling

\* Logic output can also be configured as logic input on module 2A.

♦ PDS Mode 1 & 2 are only supported in Module 1A.

Figure 1-11: Outputs 1 and 2 Connections

## 1.5 PDS Modes

**PDS** is a proprietary technique developed for bi-directional communication over a single pair of wires. There are several operating modes.

In **SSRx Load Doctor™** a logic output delivers a power demand signal to a TE10 solid state (SSR) relay and the SSR responds with a single load circuit failure message.

In **SSRx Enhanced Load Doctor™** a logic output delivers a power demand signal to an SSR and the SSR responds with the ON state rms load current, and two fault messages - SSR failure or heater circuit failure.

## 1.6 Snubbers

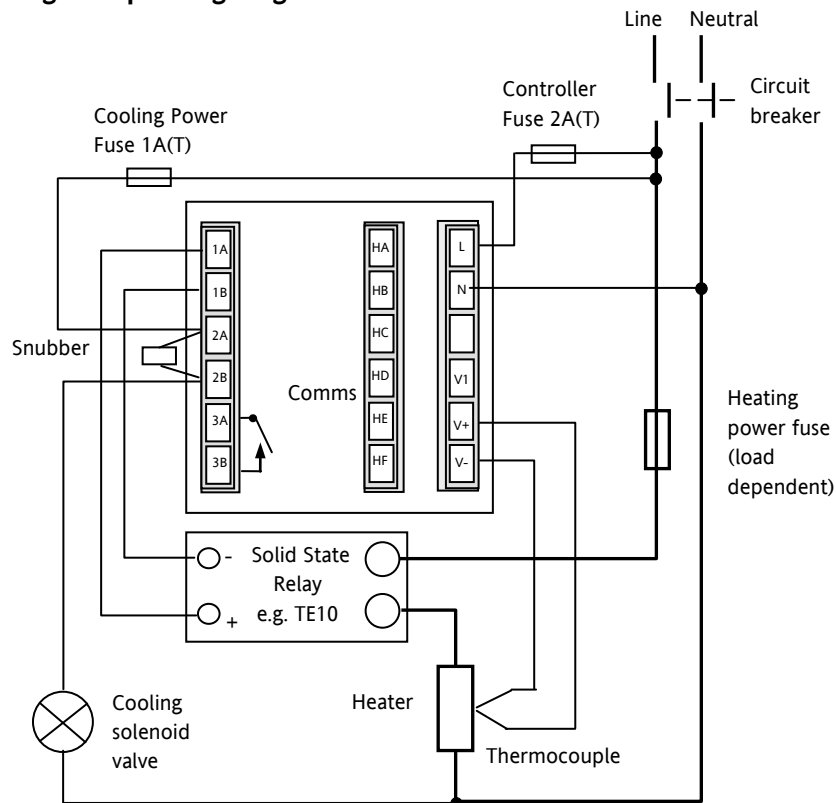
The controller is supplied with 'snubbers' (15nF +100Ω) which should be wired across the relay or triac outputs when switching inductive loads such as mechanical contactors and solenoid valves. The snubbers are used to prolong contact life and to suppress interference when switching such loads. Snubbers pass 0.6mA at 110Vac and 1.2mA at 240Vac, which may be sufficient to hold in high impedance relay coils. They should not, therefore, be used in such installations.

### WARNING



When a relay contact is used in an alarm circuit ensure that the current passing through the snubber when the relay contact is open does not hold in low power electrical loads and thereby interfere with the failsafe operation of the alarm circuit.

## 1.7 Typical single loop wiring diagram



**Figure 1-12: Typical Wiring Diagram, Model 2216e Controller**

Safety requirements for permanently connected equipment state:

- A switch or circuit breaker shall be included in the building installation
- It shall be in close proximity to the equipment and within easy reach of the operator
- It shall be marked as the disconnecting device for the equipment.

Note: a single switch or circuit breaker can drive more than one instrument.

## 1.8 Logic Drive Fan Out

The logic outputs from the 2200 series controllers are capable of driving more than one solid state relay (SSR) in series or parallel. The following table shows the number of SSRs which can be driven depending on type of SSR.

S = Series; P = Parallel.

	Drive mA	SVDA	RVDA	TE10S	425S		
		Logic DC	Logic DC	Logic DC	Logic 10V	Logic 24V	Logic 20mA
Logic	18V@24	4S 6P	4S 4P	3S 3/2P	3S 3P	1S 2P	6S 1P

	450			TC1027CE	TE200S	TC2000CE	RS3DA
	Standard	TTL	Multi-drive	Logic V	Logic DC	Logic DC	Logic DC
Logic	2S 3P	1S 2P	6S 1P	3S 4/3P	3S 4P	3S 2/1P	4S 2P

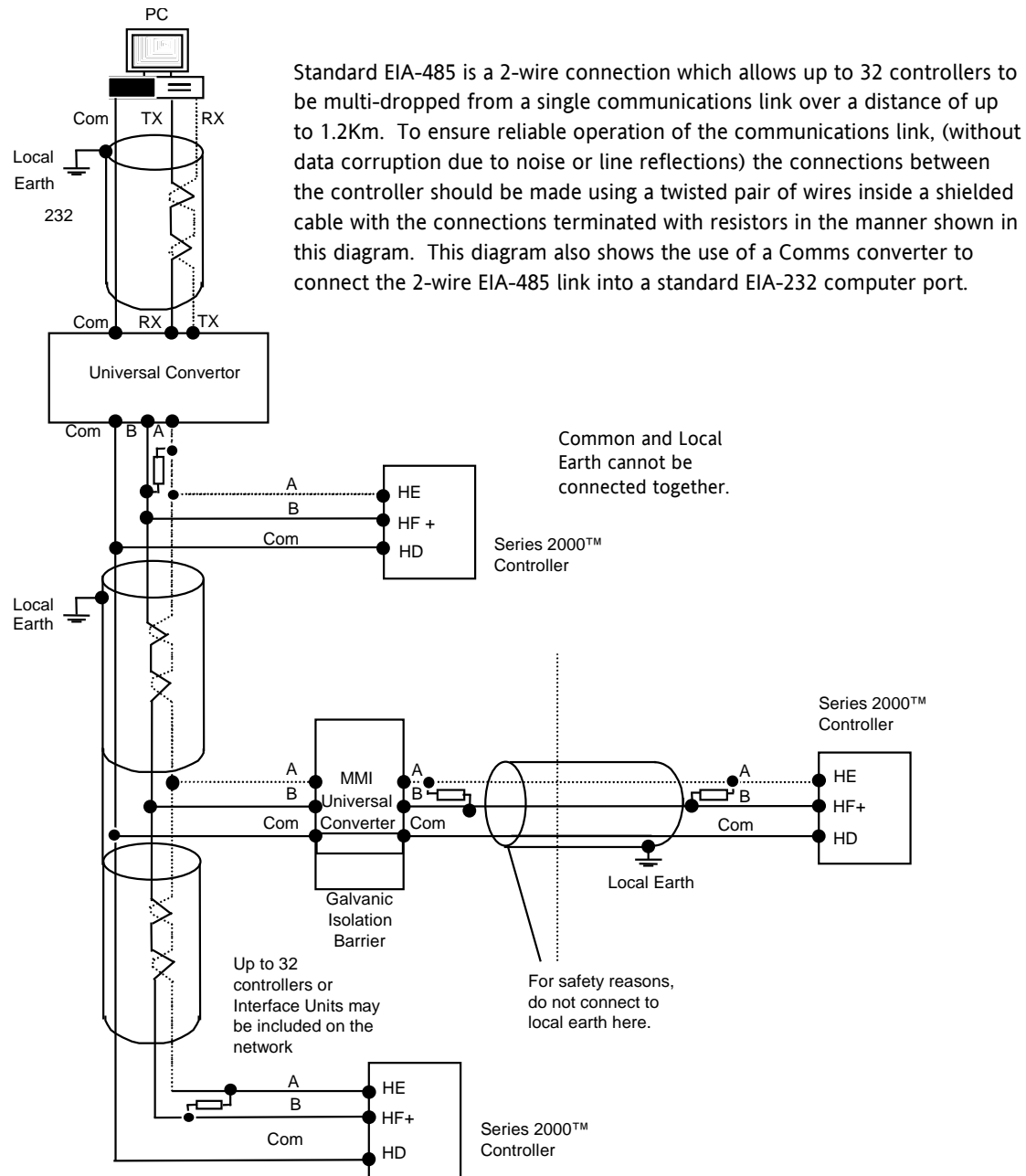
## 1.9 EIA232/485/422 Communication connections

The communication option can be either of four types shown in the table below:-

Communications type	Connection				
	HB	HC	HD	HE	HF
4-wire EIA-422 serial communications	A' (RX +)	B' (RX -)	Common	A (TX +)	B (TX -)
2-wire EIA-485 serial communications	Do not use	Do not use	Common	A (+)	B (-)
EIA-232 serial communications	Not used	Not used	Common	A	B
PDS Setpoint input	Not used	Not used	Not used	Signal	Common

Figure 1-13: Communications Connections

1.9.1 Wiring of EIA-485 serial communication links



Note:  
 All termination resistors are 220 ohm 1/4W carbon composition.  
 Local grounds are at equipotential. Where equipotential is not available wire into separate zones using a galvanic isolator.

Figure 1-14: 2-Wire EIA-485 Wiring

### 1.10 DeviceNet® Wiring to Series 2200e Controllers

This section covers the DeviceNet digital communications option for the model 2208e and 2204e controllers. To configure DeviceNet communications refer to section 5.8.

#### 1.10.1 DeviceNet Terminal Functions

Series 2200e Terminal	CAN Label	Color Chip	Description
HA	V+	Red	DeviceNet network power positive terminal. Connect the red wire of the DeviceNet cable here. If the DeviceNet network does not supply the power, connect to the positive terminal of an external 11-25 Vdc power supply.
HB	CAN_H	White	DeviceNet CAN_H data bus terminal. Connect the white wire of the DeviceNet cable here.
HC	SHIELD	None	Shield/Drain wire connection. Connect the DeviceNet cable shield here. To prevent ground loops, the DeviceNet network should be grounded in only one location.
HD	CAN_L	Blue	DeviceNet CAN_L data bus terminal. Connect the blue wire of the DeviceNet cable here.
HE	V-	Black	DeviceNet network power negative terminal. Connect the black wire of the DeviceNet cable here. If the DeviceNet network does not supply the power, connect to the negative terminal of an external 11-25 Vdc power supply.

Notes:

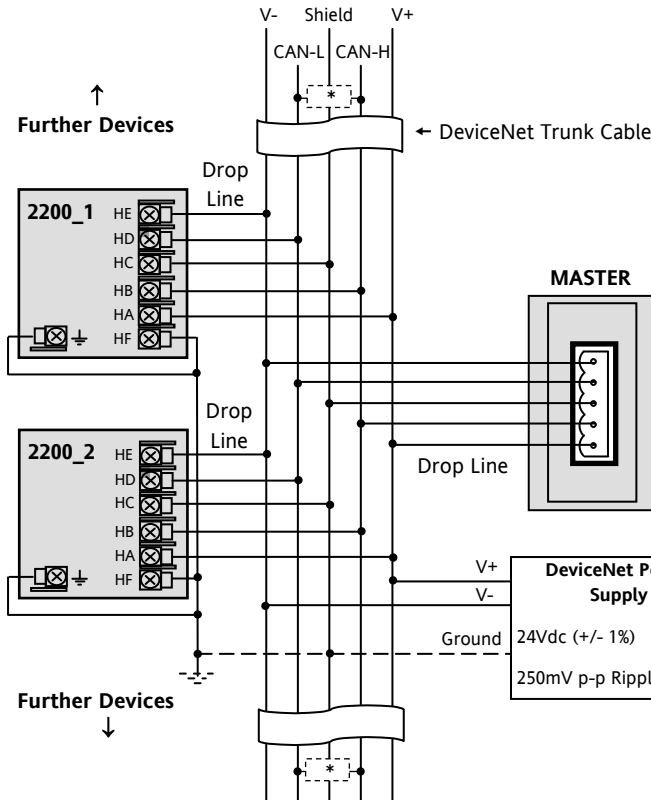


Power taps are recommended to connect the DC power supply to the DeviceNet trunk line. Power taps include:

A Schottky Diode to connect the power supply V+ and allows for multiple power supplies to be connected.

Two fuses or circuit breakers to protect the bus from excessive current which could damage the cable and connectors.

#### 1.10.2 Wiring Interconnections for DeviceNet Communications



\* 121Ω 1% 1/4W terminating resistor must be connected across the blue and white wires at each end of the DeviceNet trunk cable.  
 Note: this resistor is sometimes included in the master or other devices but should only be switched into circuit on the last device on the trunk cable.

Note:  
 The DeviceNet network is powered by an external independent 24V supply which is separate from the internal powering of the individual controllers.  
 The earth connection, HF, to be connected to the main supply earth terminal at one point only.

Figure 1-15: Wiring Connections for 2200e Series DeviceNet Controllers



## 2 Operation

### 2.1 Front Panel Layout

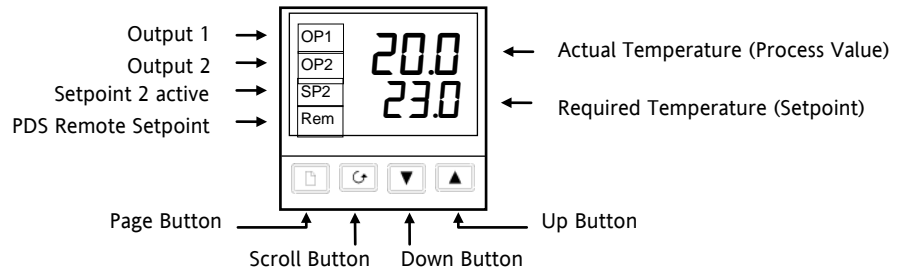


Figure 2-1: Model 2216e Front Panel Layout

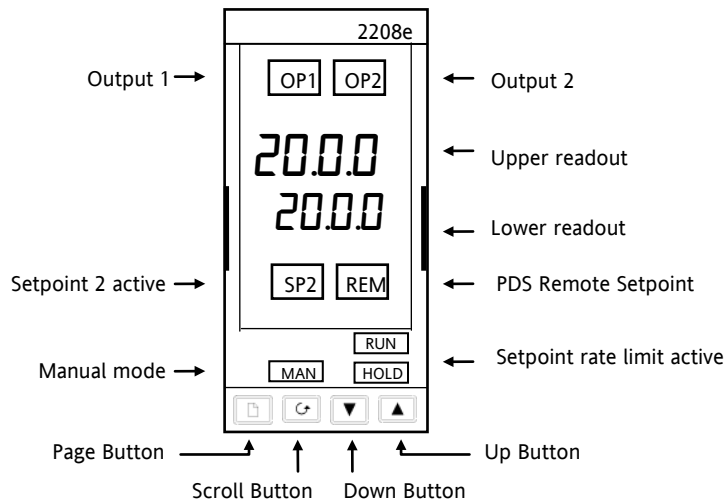


Figure 2-2: Model 2208e Front Panel Layout

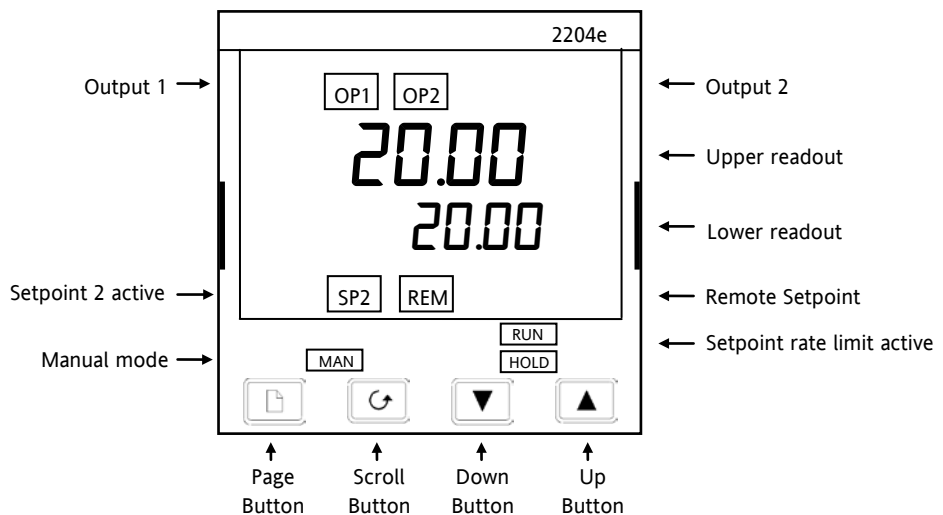






Figure 2-3: Model 2204e Front Panel Layout

☺ **Tip:** The display may flash an alarm message. Refer to the Parameter Tables in section 2.9 for a complete list and meaning of the messages.

Button or indicator	Name	Explanation
OP1	Output 1	When lit, it indicates that heating output is on.
OP2	Output 2	When lit, it indicates that cooling output is on.
SP2	Setpoint 2	When lit, this indicates that Setpoint 2 has been selected.
REM	Remote Setpoint	When lit, this indicates that the PDS remote Setpoint input has been selected. 'REM' is also used to indicate that user comms is active.
MAN	Manual light	When lit, it indicates that manual mode has been selected
RUN	Run light	When lit, it indicates that Setpoint rate limit is active.
	Page button	Press to select a new list of parameters.
	Scroll button	Press to select a new parameter in a list.
	Down button	Press to decrease a value in the lower readout.
	Up button	Press to increase a value in lower readout.

**Figure 2-4: Controller Buttons and Indicators**

☺ Tip: For Valve Positioning, please refer to section 8 'Motorised Valve Control'.

## 2.2 Getting Started

Thank you for selecting this controller.

This section shows the **principle** of operation. Views are generally shown for 2404 controller.

### 2.2.1 To View The Process Value and Setpoint

**Install and wire up** the controller as explained in section 1.4 and switch on.

Following a 3 second self-test sequence, this is the display you will see,

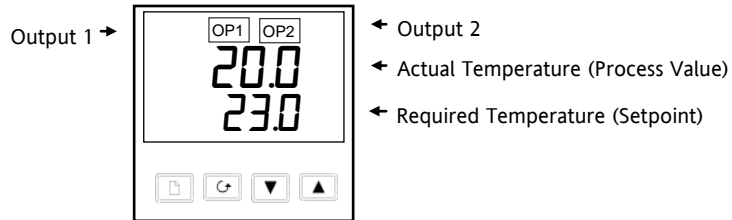


Figure 2-5: The "HOME Display"

☺ **Tip:** The display may flash an alarm message. Refer to the Parameter Tables in section 2.9 for a complete list and meaning of the messages.

### 2.2.2 To Adjust The Setpoint

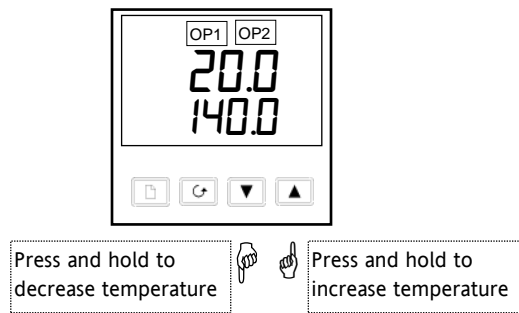


Figure 2-6: The Lower Readout Shows the Setpoint

After 2 seconds the lower readout will 'blink' indicating that the new value has been accepted.

For everyday use you may not need to do anymore than this.

### 2.2.3 To View The Display Units

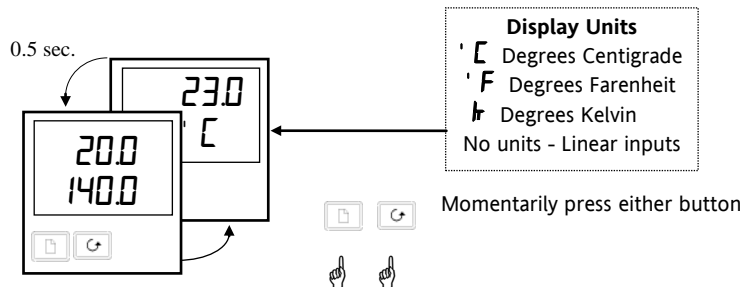


Figure 2-7: Viewing the Display Units

☺ **Tip:** If you get lost, pressing  and  together will return you to the Home display.

### 2.2.4 Use Of The 'SCROLL' Button

Pressing the scroll button will display the output power level. Continued pressing will display further parameters in the operator scroll list.

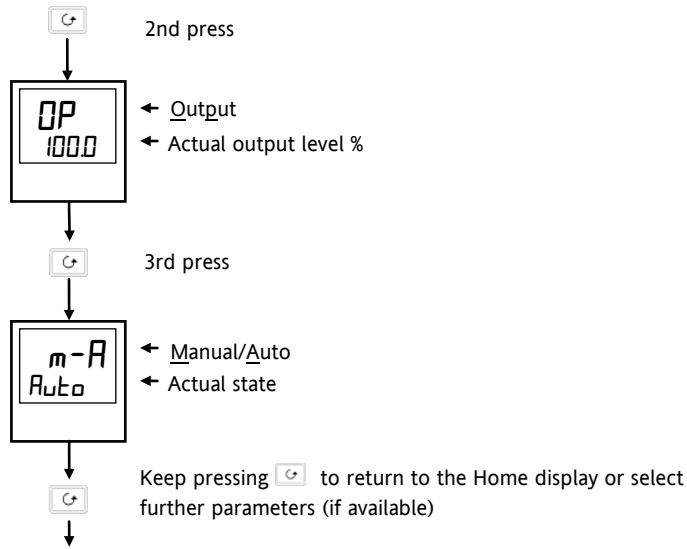



Figure 2-8: The Scroll Button

### 2.2.5 Use Of The 'PAGE' Button

The page button  accesses parameter LISTS.

Parameters are settings in the instrument which, generally, can be changed by the user to suit the process. Examples are: Alarms, Self Tune, etc. They are found under headings called **LISTS** and a full set is given later in this chapter.

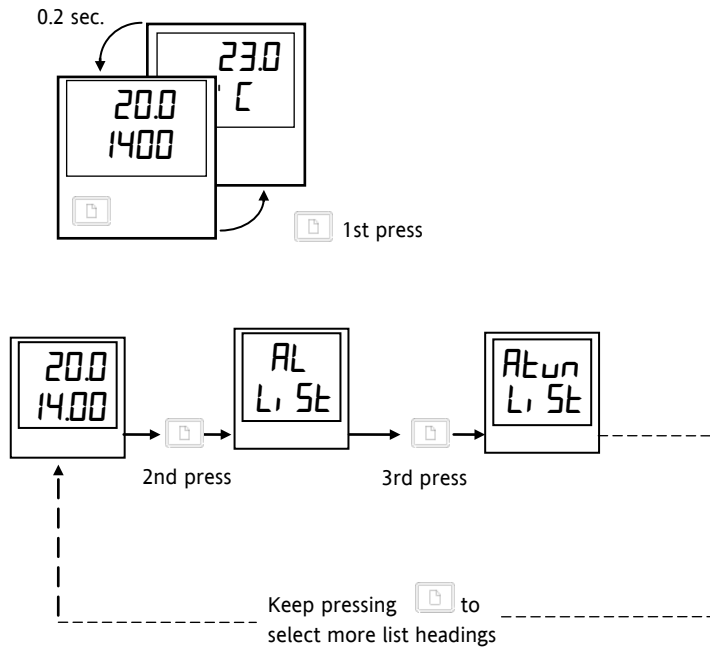

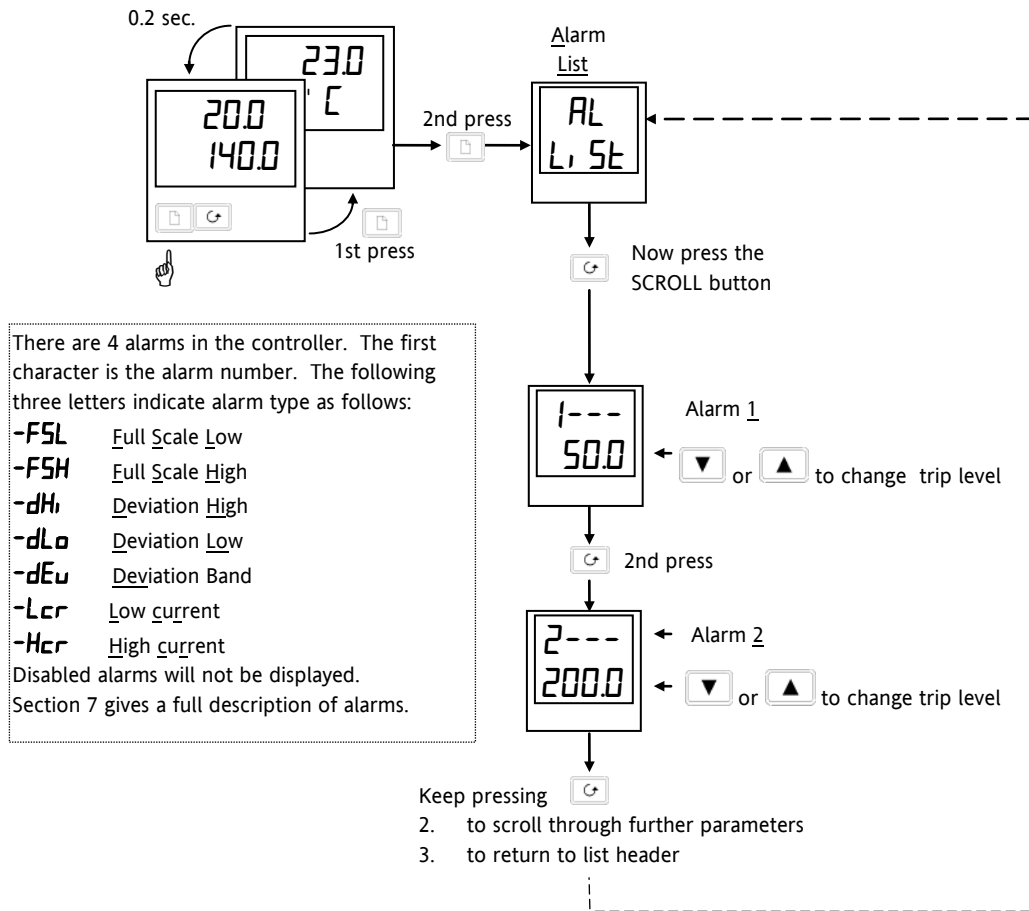


Figure 2-9: The Page Button

☺ Tip: The actual list headings may be longer or shorter than indicated above and you can customise this for the operator's convenience in EDIT level, section 3.

### 2.3 Parameter Lists

Press  to choose a LIST - "ALARMS" is a good one. This list allows you to set the alarm trip levels. The parameters which appear in the list will vary according to the configuration of your controller.



☺ Tip: If, at any time, no key is pressed within 45 seconds, the display will always return to the "HOME" display.

A description of the parameter lists is given in section 2.9.

**Figure 2-10: Choosing a List of Parameters**

## 2.4 Manual or Automatic Control

The controller can be used in two modes:

**Automatic mode** - in which the output power is automatically adjusted to hold the temperature at the required value. The controller normally operates in this mode.

**Manual mode** - in which the output is manually adjusted by the Operator. In this mode the 'MAN' light will be on.

One other mode is available:

**Remote setpoint** - The setpoint is generated as an input signal from a master 2000 or 3000 series controller. In this mode the REM light is on.

### 2.4.1 To Select Auto/Manual Operation

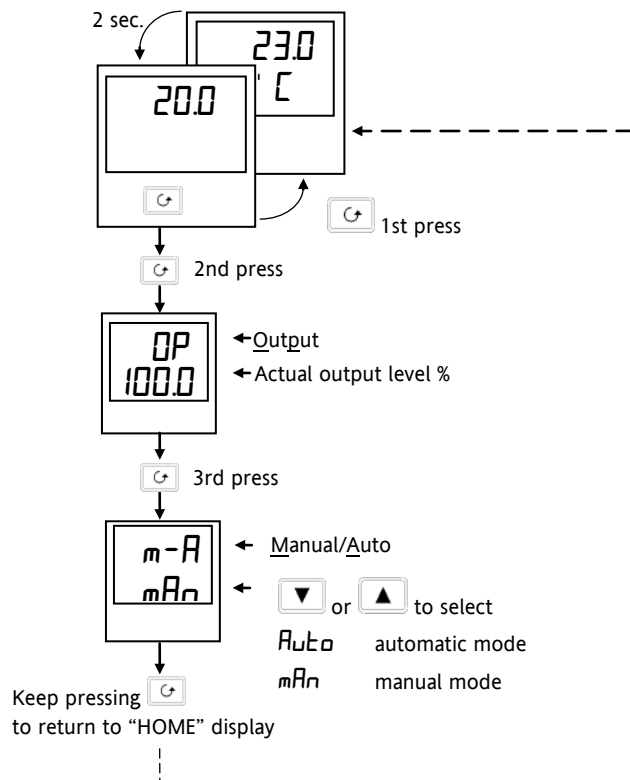


Figure 2-11: Auto/Manual Select

### 2.4.2 To Adjust Output Power in Manual Mode

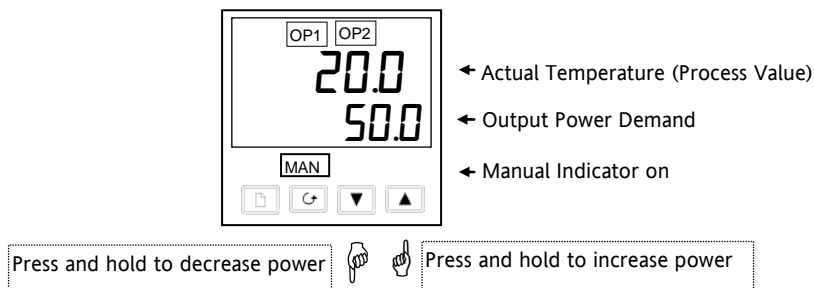


Figure 2-12: The "Home" Display in Manual Mode

☺ Tip: Manual mode is generally used for test and commissioning purposes, take care not to leave the controller in this mode since damage to the process or personal injury could occur.

## 2.5 SETPOINT 1 OR SETPOINT 2

The instrument has the facility to select between two setpoints. This may be useful, for example, where it is required to switch control between two different setpoints or to control in a standby condition, thus avoiding the necessity to change the setpoint manually each time.

### 2.5.1 To Select Setpoint 1 or Setpoint 2

This may be done in two ways:-

1. By an external switch or relay contact wired to a digital input
2. Through the front panel using the *SP* list

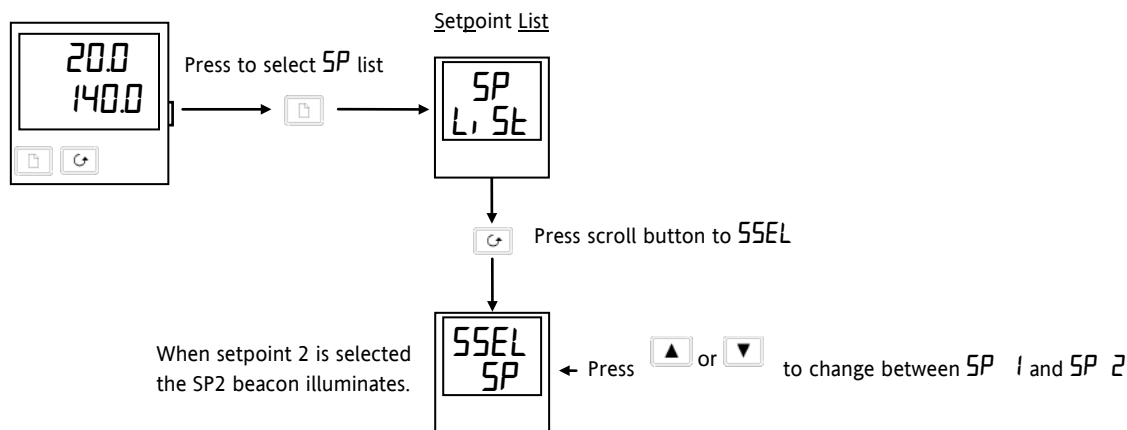


Figure 2-13: Selecting Setpoint 1 or 2

## 2.6 Ramp Dwell Function

The ramp dwell function is selected by turning the setpoint rate limit parameter *SPrr* to a value. It can be set to RUN in two ways:-

1. Through the front panel using the *SP* list
2. By an external switch or relay contact wired to a digital input configured for reset (*rSEt*). When closed the program will reset. When open the program will run. To run the program from the initial reset state, it is necessary to first close the switch then open it.


The controller will then ramp from setpoint 1 to setpoint 2 at a rate set by the *SPrr* parameter.

When the controller reaches setpoint 2 it can remain at this level for a timed period, using the *dwEl* parameter.

At the end of the dwell period the action of the controller is determined by the End Type parameter *Endt*.



### 2.6.1 To Set up a Ramp/Time Program

Set setpoint 1 to the value at which to start the ramp. Set setpoint 2 to the value which you wish to ramp to. This is described in the previous section.

Now press  until *SPrr* is displayed





In Run mode the controller will ramp from SP 1 to SP 2 at 20.0 units per minute

Press  or  to set the SP\_ramp\_rate in units per minute

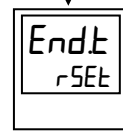
Press scroll button to *dwEll*



In Run mode the controller will dwell at SP 2 for 60 minutes



Press  or  to set the dwell time in minutes

Press scroll button to *Endt*



In Run mode the controller will reset at the end of the dwell time. Other choices are:-

<i>HoLd</i>	The program will freeze
<i>StBY</i>	The program will go into standby
<i>dwEll</i>	The program will dwell for an unlimited period

Press  or  to choose the action required at the end of the dwell time

**Figure 2-14: Ramp/Dwell Program**

### 2.6.2 To Run the Program

From the previous view, press scroll button to *Prog*



Press  or  to choose *run*

To reset the controller to start conditions, select *rSEt*

In Full access level the Status of the program can be read as follows:-

From the previous view, press scroll button to *StAt*



The status may be any one of the following:

<i>rmp</i>	Ramping from SP1 to SP2
<i>dwEll</i>	Dwelling at SP2
<i>End</i>	The program is complete. If <i>Endt</i> = <i>rSEt</i> , <i>End</i> will flash briefly before changing to <i>OFF</i>
<i>OFF</i>	The program is in the reset state

**Figure 2-15: Program Run**

A program may also be reset or run using an external switch contact if a digital input has been configured. See Configuration section 5.

### 2.6.3 Power Failure During Program Run

1. During Ramp. After return of power, the working setpoint will servo to the current PV value, and the ramp continues to SP2 followed by the timed dwell.
2. During Dwell. After return of power the working setpoint will servo to PV, the ramp continues to SP2 followed by full programmed dwell. In effect this causes the program to restart.

☺ Tip: Use the Hide, Reveal and Promote features to customise the display for a programmer. See section 3.



### 2.7 Location of Parameters - Block Diagram

The controller consists of a number of internal function blocks connected together to create a temperature controller. Each function block has a number of parameters found in lists to which the user has access. The block diagram shows location of these parameters within the controller.

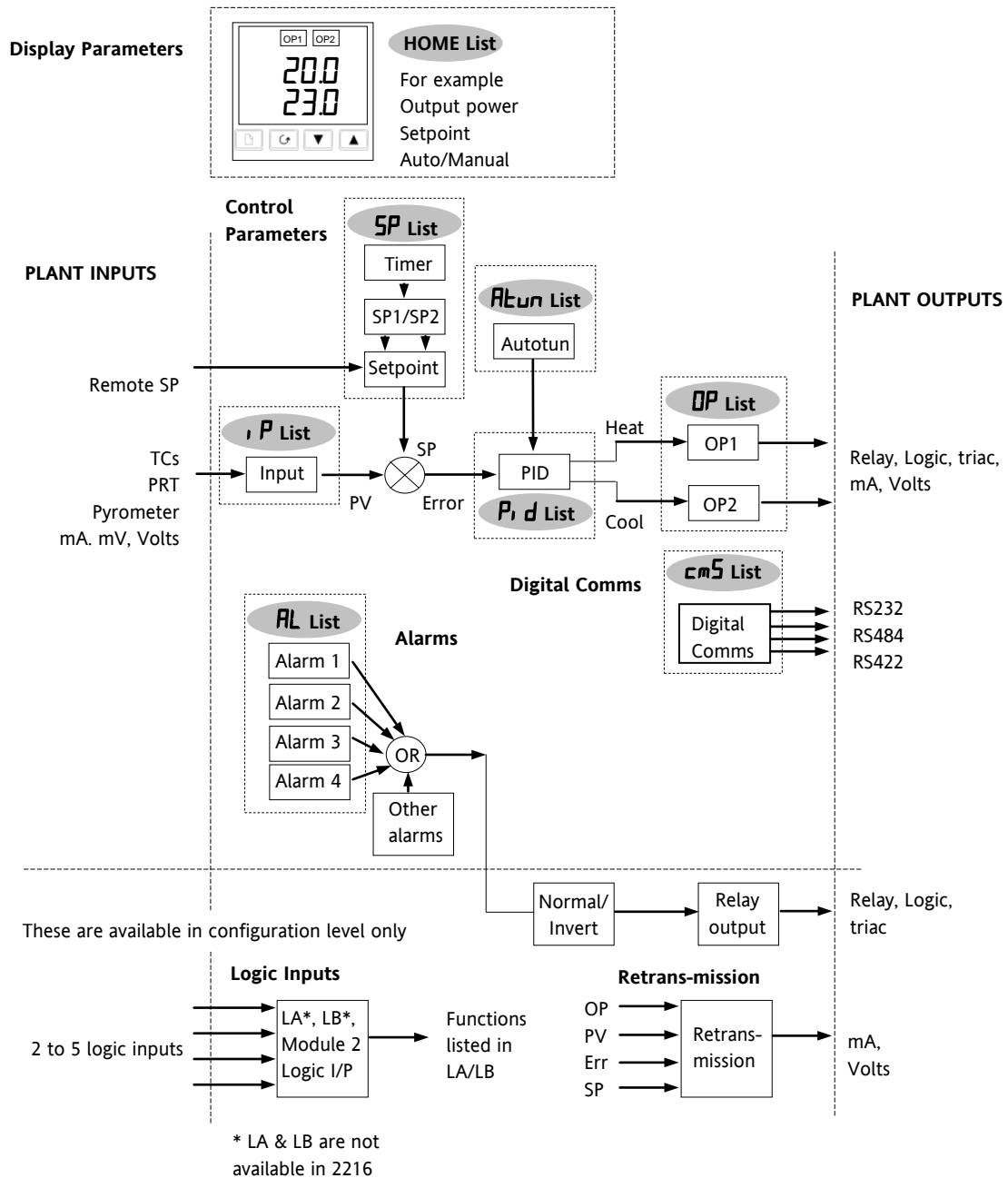


Figure 1-14 Controller Block Diagram

## 2.8 Navigation Diagram

The navigation diagram shows a complete list of possible parameters. However, some may not appear because they are dependent upon a particular controller variant.

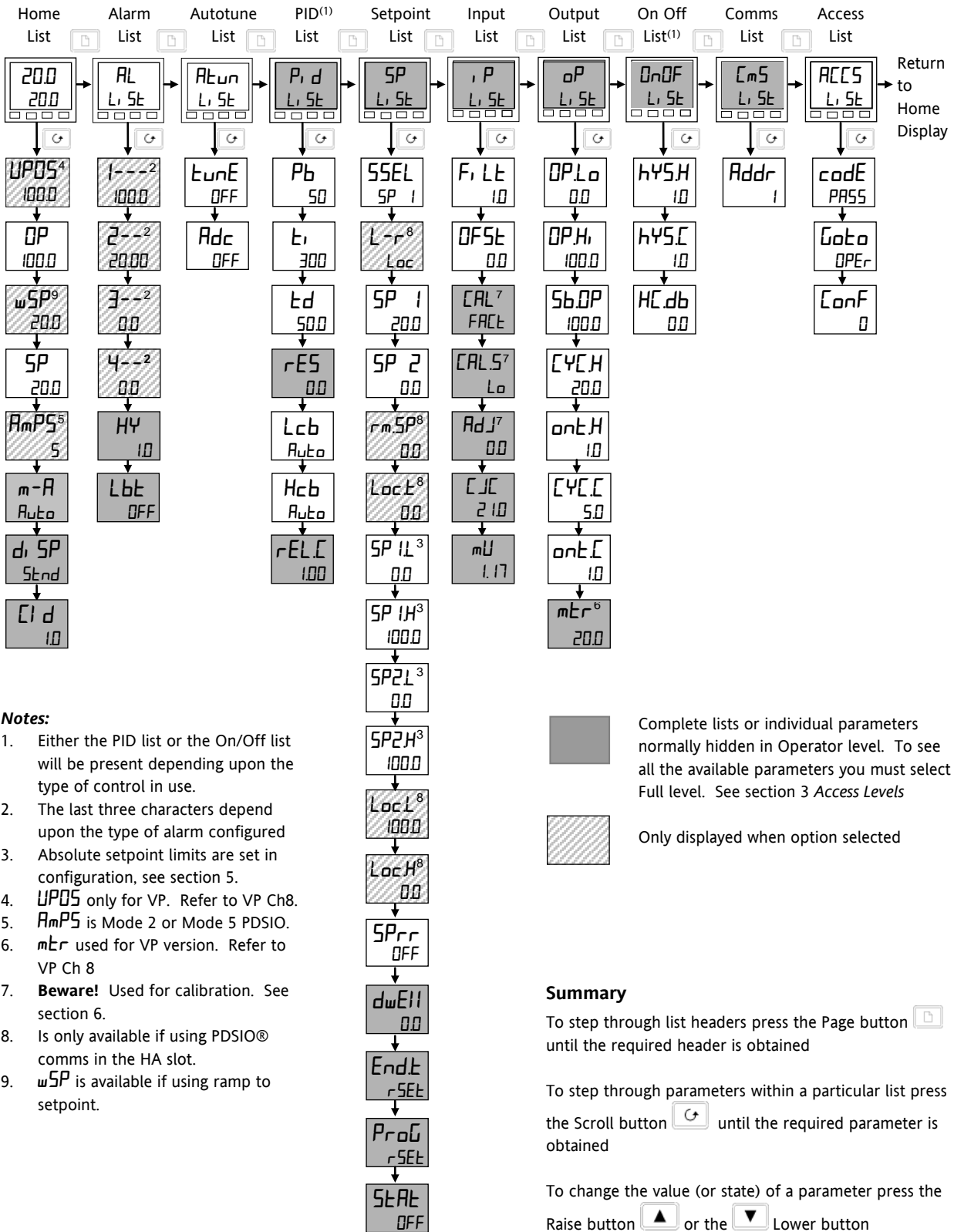


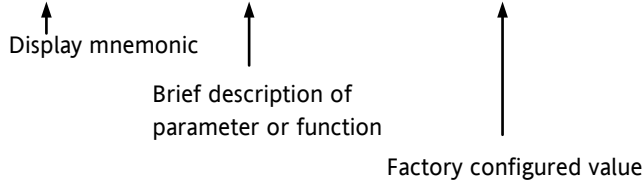
Figure 2-16: Navigation Diagram

The remainder of this chapter provides a complete list of all parameters available.

### 2.9 Parameter Tables

The tables which follow list all parameters that are available in Full operator level.

Name	Parameter Description	Default Value		Min Value	Max Value	Units	Customer Setting
		UK	USA				



#### 2.9.1 HOME Display

Name	Parameter Description	Default Value		Min Value	Max Value	Units	Customer Setting
		UK	USA				

Home List							
Home	Measured Value and Setpoint(SP)	SP=25°C	SP=75°F			as display	
<u>uPoS</u>	Valve positioner output power			00	1000	%of mtr	
<u>OP</u>	% <u>Output</u> Level			- 1000	1000	%	
<u>wSP</u>	Working setpoint					as display	
<u>SP</u>	Setpoint			-999	9999	as display	
<u>AmPS</u>	Heater current (PDS modes 2 and 5)			0	100	AmPS	
<u>m-A</u>	<u>Auto</u> / <u>manual</u> select	<u>Auto</u>	<u>Auto</u>				
<u>d, SP</u>	Configure lower readout of home display	<u>Std</u>	<u>Std</u>				<u>None</u> <u>Std</u> <u>AmPS</u> <u>OP</u> <u>Std</u> <u>uPoS</u>
<u>C, d</u>	Customer ID	0	0	0	9999		

Additional parameters may appear in the Home display if the 'promote' feature has been used (see *Edit Level*, section 3).

#### 2.9.2 Alarm List

Name	Parameter Description	Default Value		Min Value	Max Value	Units	Customer Setting
		UK	USA				

AL Alarm List							
<u>1---</u>	Alarm <u>1</u> set point value	0	0			as display	
<u>2---</u>	Alarm <u>2</u> set point value	0	0			as display	
<u>3---</u>	Alarm <u>3</u> set point value	0	0			as display	
<u>4---</u>	Alarm <u>4</u> set point value	0	0			as display	
<i>In place of dashes, the last three characters indicate the alarm type, as follows:</i>							
<u>-FSH</u>	<u>Full Scale High</u> alarm			-999	9999	as display	
<u>-FSL</u>	<u>Full Scale Low</u> alarm			-999	9999	as display	
<u>-dEu</u>	<u>Deviation band</u> alarm			0	9999	as display	
<u>-dHi</u>	<u>Deviation High</u> alarm			0	9999	as display	
<u>-dLo</u>	<u>Deviation Low</u> alarm			0	9999	as display	
<u>-Lcr</u>	Low current alarm			0	100	AMPS	
<u>-Hcr</u>	High current alarm			0	100	AMPS	
<u>HY</u>	Hysteresis			0	9999	as display	
<u>HYEU</u>	Hysteresis for event alarms. <b>See Note 1</b>			0	9999	as display	
<u>Lbt</u>	<u>Loop break time</u>	<u>OFF</u>	<u>OFF</u>	0	9999	secs	

**Note 1:** This parameter has been added from software version 4. Event alarms are configured in the AL Conf List.

**2.9.3 Autotune List**

Name	Parameter Description	Default Value		Min Value	Max Value	Units	Customer Setting
		UK	USA				
<b>Autun</b>	<b>Autotune List</b>						
<b>tunE</b>	Self <u>tune</u> enable	OFF	OFF	OFF	On		
<b>Adc</b>	Automatic <u>droop</u> compensation (Manual Reset) enable (only present if <b>t<sub>i</sub></b> set to OFF)	mPn	mPn	mPn	CALL		

**2.9.4 PID List**

<b>P, d</b>	<b>PID List</b>						
<b>Pb</b>	<u>Proportional</u> <u>band</u>	200	30	1	9999	as display	
<b>t<sub>i</sub></b>	<u>Integral</u> <u>time</u>	360	360	OFF	9999	seconds	
<b>t<sub>d</sub></b>	<u>Derivative</u> <u>time</u>	60	60	OFF	9999	seconds	
<b>rES</b>	Manual <u>reset</u> (appears when <b>t<sub>i</sub></b> set to OFF)	0.0	0.0	0.00	100.0	%	
<b>Lcb</b>	<u>Cutback</u> <u>low</u>	Auto	Auto	0	9999	as display	
<b>Hcb</b>	<u>Cutback</u> <u>high</u>	Auto	Auto	0	9999	as display	
<b>rELC</b>	<u>Relative</u> <u>cool</u> gain (set 1)	1.00	1.00	0.01	9.99		

**2.9.5 Setpoint List**

<b>SP</b>	<b>Set Point List</b>						
<b>SSEL</b>	Select <u>SP1</u> or <u>SP2</u>	SP1	SP1	SP1	SP2		
<b>L-r</b>	<u>Local</u> or <u>remote</u> setpoint select	Loc	Loc	Loc	rmE		
<b>SP1</b>	<u>Setpoint</u> <u>1</u> value	25	70	As display range			
<b>SP2</b>	<u>Setpoint</u> <u>2</u> value	25	70	As display range			
<b>rmSP</b>	<u>Remote</u> <u>setpoint</u>	0	0	As display range			
<b>LocE</b>	<u>Local</u> <u>trim</u>	0	0	As display range			
<b>SP1L</b>	<u>Setpoint</u> <u>1</u> <u>low</u> limit	0	32	As display range			
<b>SP1H</b>	<u>Setpoint</u> <u>1</u> <u>high</u> limit	1000	2100	As display range			
<b>SP2L</b>	<u>Setpoint</u> <u>2</u> <u>low</u> limit	0	32	As display range			
<b>SP2H</b>	<u>Setpoint</u> <u>2</u> <u>high</u> limit	1000	2100	As display range			
<b>LocL</b>	<u>Local</u> setpoint trim <u>low</u> limit	-210	-346	As display range			
<b>LocH</b>	<u>Local</u> setpoint trim <u>high</u> limit	1200	2192	As display range			
<b>SPrr</b>	<u>Setpoint</u> <u>rate</u> limit	OFF	OFF	Units per minute			
<b>dwE11</b>	<u>Dwell</u> time	OFF	OFF	0.1 to 999.9 minutes			
<b>EndE</b>	<u>End</u> type	rSEt	rSEt	rSEt hoLd StbY dwE11			
<b>Prog</b>	<u>Program</u> control	rSEt	rSEt	run' rSEt			
<b>StAE</b>	<u>Status</u> of program	OFF	OFF	rmP dwE11 End OFF			

### 2.9.6 Input List

Name	Parameter Description	Default Value		Min Value	Max Value	Units	Customer Setting
		UK	USA				

IP	Input list						
*FILT	Input filter time constant	16	16	0.0 OFF	9999	secs	
OFFS	PV Offset			-999	9999	as display	
The next 5 parameters will appear if User calibration has been enabled in configuration level. To perform a user calibration refer to Ch 6.							
CAL	FACT will re-instate factory settings and disable User Calibration. Default setting FACT USER will re-instate any previously set User Calibration offsets and make available User Calibration parameters as follows:						
CALS	User calibration select	nonE	nonE				Hi ' Lo' nonE
Adj~	Adjust calibrated reference source						
The following two parameters are always present in Full Access level but not in Operator level							
CJC°	Cold junction compensation temperature						
mV	Millivolt input						

\* A minimum filter time constant of one second is recommended to provide sufficient noise immunity.

~ Do not make adjustments to the Adj parameter unless you wish to offset the controller calibration.

### 2.9.7 On/Off List

OnOff	On/off list						
This set of parameters only appear if On/Off control has been configured							
hYSH	Heat hysteresis	0	0	0	9999	as display	
hYCL	Cool hysteresis	0	0	0	9999	as display	
HEdb	Heat/Cool dead band	1	1	0	9999	as display	

### 2.9.8 Output List

OP	Output list	Note; if On/Off control is configured only SbDP, ontH and ontC will appear in the following list					
OPLo	Low (power) output limit	0.0 or -100.0 (cool)		-100.0	100.0	%	
OPHi	High (power) output limit	100.0	100.0	-100.0	100.0	%	
SbDP	Output setting when in sensor break	0.0		-100.0	100.0	%	
<sup>(1)</sup> EYCH	Heat cycle time	1.0 (logic) 2.0 (relay)		0.2	999.9	secs	
ontH	Heat output min. on time	0.1	0.1	AUTO (50mS)	999.9		
<sup>(1)</sup> EYCL	Cool cycle time	1.0 (logic) 2.0 (relay)		0.2	999.9	secs	
<sup>(1)</sup> ontC	Cool output min. on time	0.1	0.1	AUTO (50mS)	999.9	secs	
mtR	VP motor travel time			0.0	999.9	secs	

(1) Not used for Valve Position Control.

**2.9.9 Communications List**

Name	Parameter Description	Default Value		Min Value	Max Value	Units	Customer Setting
		UK	USA				

<b>cms</b>	<b>Comms list</b>						
<b>Addr</b>	Communications address	1	1	1	254		

**2.9.10 Access List**

<b>ACCESS</b>	<b>Access list</b>						
<b>codE</b>	Full and Edit level password	1	1	0	9999		
<b>Goto</b>	Goto level -OPER, FULL, Edit or CONF	OPER	OPER	OPER	CONF		
<b>CONF</b>	Configuration level password	2	2	0	9999		

## 2.10 Alarms

**Alarms** are used to alert an operator when a pre-set level has been exceeded. They are normally used to switch an output (see 2.11) – usually a relay – to provide external actions to the process.

**Soft Alarms** are indication only and do not operate an output.

**Events** are generally defined as conditions, which occur as part of the operation of the plant. They do not require operator intervention and, therefore, do not cause an alarm message to be displayed. They can be attached to operate an output (relay) in the same way as an alarm.

### 2.10.1 Types of Alarm Used in the 2200

This section shows graphically the operation of different types of alarm used in the controller. The graphs show changes in PV plotted against time.

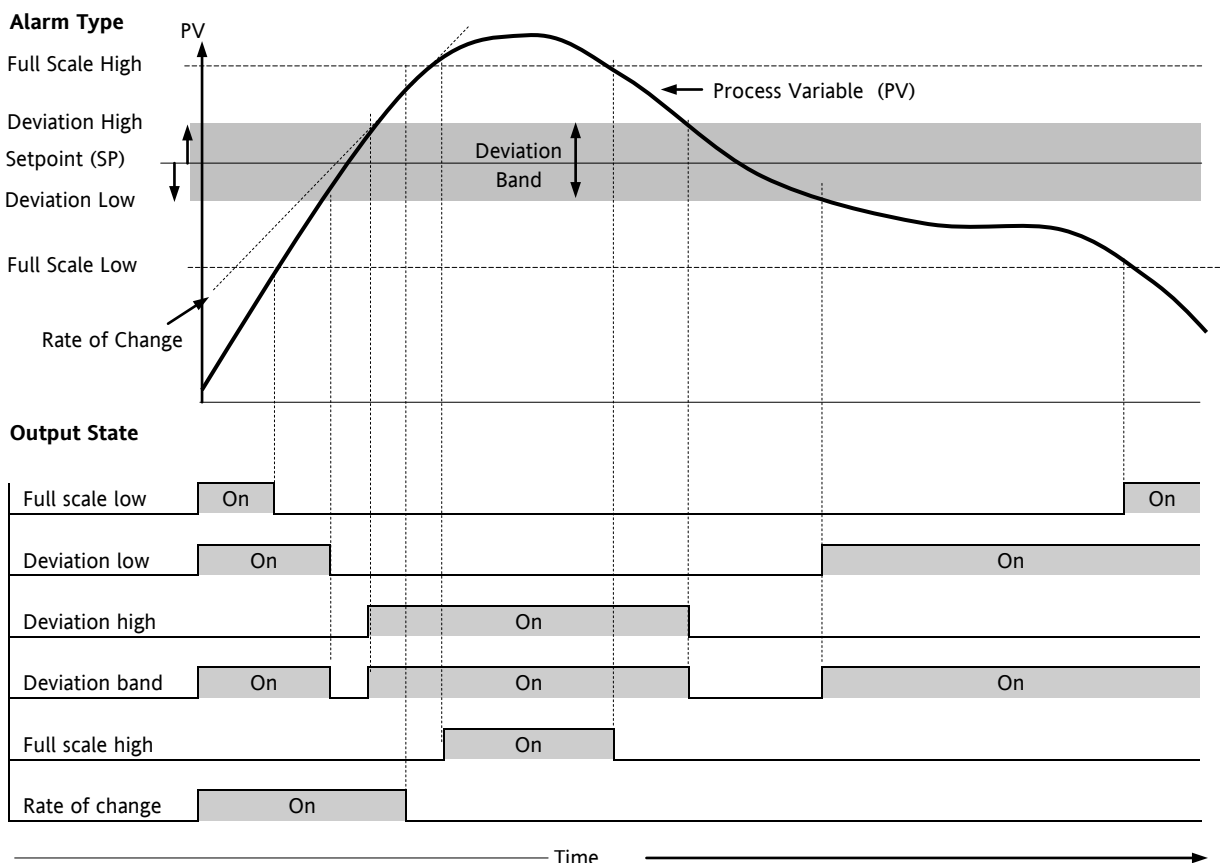


Figure 2-17: Alarm Types

**Hysteresis** is the difference between the point at which the alarm switches ON and the point at which it switches OFF.

It is used to prevent relay chatter.

**Blocking Alarms** only occur after the start up phase when the alarm has first entered a safe state. The alarm is only indicated the next time it is active. It is used, for example, to ignore start up conditions which are not representative of running conditions.

**Latching Alarms** see 7.1.1.

**Loop Break Alarm.** The control loop is considered to be open if the output demand signal increases to saturation level but the error does not reduce after a set period of time. The time period can be set manually, depending on the response time of the loop, using the parameter  $LbT$  in the Alarm List (section 2.9.2). It is, also set automatically, following an autotune (see section 4), to  $3 \times t_i$  (integral time). The time period,  $LbT$ , starts from the point at which the output demand reaches saturation. The loop break alarm  $Lbr$  is displayed (as a diagnostic alarm, see section 2.11.3) at the end of this period.

### 2.11 Alarm Relay Output

☺ Tip. Alarms can operate a specific output (usually a relay). Any individual alarm can operate an individual relay or any combination of alarms can operate an individual relay. They are either supplied pre-configured in accordance with the ordering code or set up in configuration level.

See section 5 for further information.

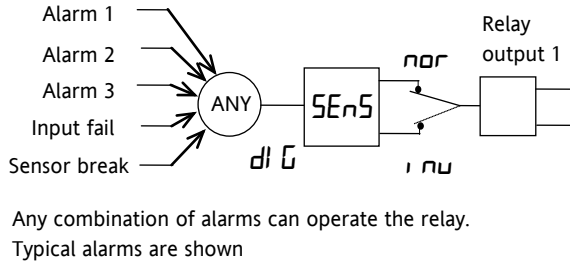


Figure 2-18: Attaching Alarms to an Output

#### 2.11.1 Setting Alarm Levels

Up to 4 Alarms may be configured. Each alarm is given a name to describe its function - see table below:

If an alarm is not configured it does not appear in the list below.

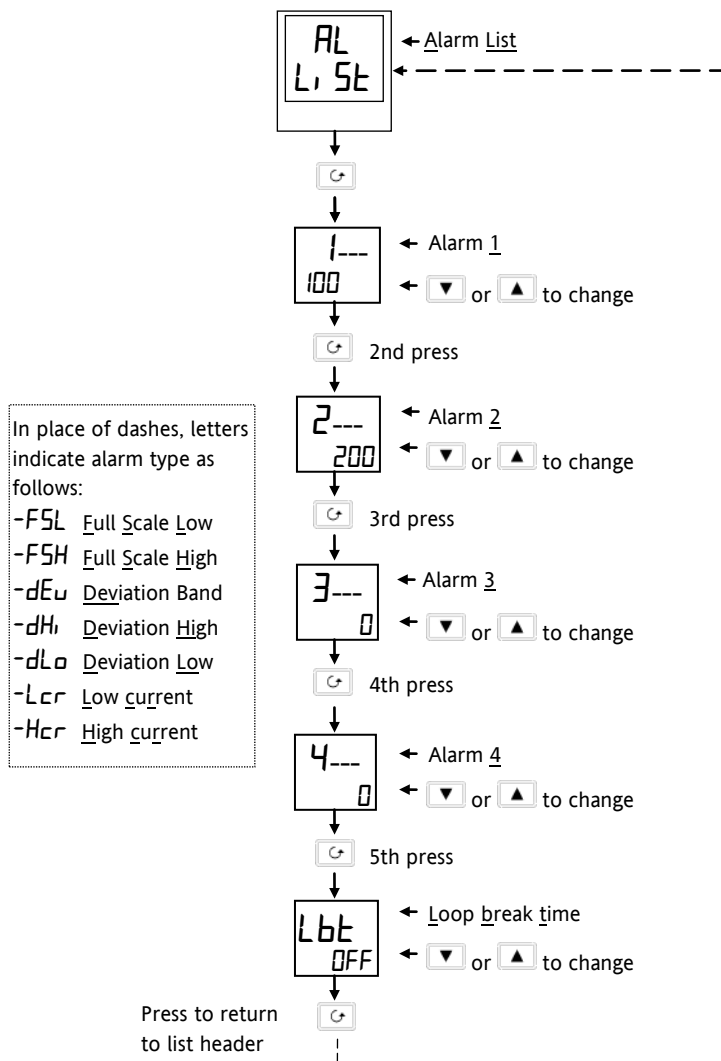




Figure 2-19: To Set Alarm Trip Levels



### 2.11.2 Alarm Indication and Acknowledgement

When an alarm occurs, the alarm mnemonic (e.g. *IFSH*) will be indicated by a double flash in the HOME display. Similarly, if more than one alarm occurs the relevant mnemonics are flashed in the HOME display. The double flash will continue whilst the alarm condition is present and is not acknowledged.

Press  and  together to acknowledge the alarm.

If the alarm condition is still present when the alarm is acknowledged, it will be indicated by a single flash of the alarm mnemonic and this single flash will be repeated for as long as the alarm condition remains. When the alarm condition disappears the indication will also disappear.

If the alarm condition is no longer present when the alarm is acknowledged, the flashing message will disappear immediately on acknowledgement.

If a relay has been attached to the alarm output (see section 7 'Alarm Operation'), it will operate when the alarm condition occurs and remain in the operated condition until the alarm is acknowledged AND it is no longer present

### 2.11.3 Diagnostic Alarms

These indicate that a fault exists in either the controller or the connected devices.

Display shows	What it means	What to do about it
<i>EEEr</i>	<i>Electrically Erasable Memory Error:</i> The value of an operator or configuration parameter has been corrupted	This fault will automatically take you into configuration level. Check all of the configuration parameters before returning to operator level. Once in operator level, check all of the operator parameters before resuming normal operation. If the fault persists or occurs frequently, contact your supplier
<i>Sbr</i>	<i>Sensor Break:</i> Input sensor is unreliable or the input signal is out of range	Check that the sensor is correctly connected
<i>Lbr</i>	<i>Loop Break:</i> The feedback loop is open circuit	Check that the heating and cooling circuits are working properly
<i>LdF</i>	<i>Load failure</i> Indication that there is a fault in the heating circuit or the solid state relay	This is an alarm generated by feedback from a TE10S solid state relay (SSR) operating in PDS SSRx mode. It indicates either an open or short circuit SSR, blown fuse, missing supply or open circuit heater
<i>SSrF</i>	<i>Solid state relay failure</i> Indication that there is a fault in the solid state relay	This is an alarm generated by feedback from a TE10S solid state relay (SSR) operating in PDS SSRx mode. It indicates either an open or short circuit condition in the SSR
<i>HtErF</i>	<i>Heater failure</i> Indication that there is a fault in heating circuit	This is an alarm generated by feedback from a TE10S solid state relay (SSR) operating in PDS SSRx mode. It indicates either a blown fuse, missing supply or open circuit heater
<i>HwEr</i>	<i>Hardware error</i> Indication that a module is the wrong type	Check that the correct modules are fitted
<i>no. i o</i>	<i>No I/O module</i> Modules are configured but not fitted	This error message normally occurs when pre-configuring a controller without installing any of the required I/O modules
<i>rmErF</i>	<i>Remote input failure.</i> The PDS input is open circuit. (PDS Also known as SST – Smart Setpoint Transmission)	Check for open or short circuit wiring on the PDS input
<i>LLLL</i>	<i>Out of Display range, low reading</i>	Check the value of the display range
<i>HHHH</i>	<i>Out of Display range, high reading</i>	Check the value of the display range
<i>Err1</i>	<i>Error 1: ROM self-test fail</i>	Return the controller for repair
<i>Err2</i>	<i>Error 2: RAM self-test fail</i>	Return the controller for repair
<i>Err3</i>	<i>Error 3: Watchdog fail</i>	Return the controller for repair
<i>Err4</i>	<i>Error 4: Keyboard failure</i> Stuck button, or a button was pressed during power up.	Switch the power off and then on without touching any of the controller buttons.
<i>Err5</i>	<i>Error 5: Input circuit failure</i>	Return the controller for repair*
<i>PwrF</i>	<i>Power failure.</i> The line voltage is too low	Check that the supply to the controller is within the rated limits
<i>tUEr</i>	Tune error. If any one stage of the tuning process exceeds 2 hours the tune error alarm occurs	Check response time of process: check that the sensor has not failed: check that the loop is not broken. Acknowledge by pressing 'page' button and 'scroll' button together.

**Figure 2-20: Diagnostic Alarms**

\* If the user has disassembled and reassembled the instrument, this error can occur if any connectors are not seated properly.

## 3 Access Levels

### 3.1 The Different Access Levels


Access level	Display shows	What you can do	Password Protection
Operator	OPER	In this level operators can view and adjust the value of parameters defined in Edit level (see below).	No
Full	FULL	In this level all the parameters relevant to a particular configuration are visible. All alterable parameters may be adjusted.	Yes
Edit	Edi t	In this level you can set which parameters an operator in Operator level is able to view and adjust. You can hide or reveal complete lists and individual parameters within each list, and you can make parameters read-only or alterable. You can also promote parameters to the home list. (See <i>Edit level</i> at the end of the chapter).	Yes
Configuration	CONF	This special level allows access to set up the fundamental characteristics of the controller.	Yes

### 3.2 Selecting An Access Level

Access to Full, Edit or Configuration levels is protected by a password to prevent unauthorised access.

If you need to change the password, see section 5 , *Configuration*

#### 3.2.1 Access list header



Press  until you reach the access list header 'ACCS'.

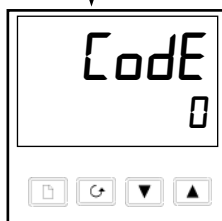


Press the Scroll button

#### 3.2.2 Password entry

The password is entered from the 'CODE' display.

Enter the password using the  or  buttons. Once the correct password has been entered, there is a two second delay after which the lower readout will change to show 'PASS' indicating that access is now unlocked.





The pass number is set to '1' when the controller is shipped from the factory.

*Note:* A special case exists if the password has been set to '0'. In this case access will be permanently unlocked and the lower readout will always show 'PASS'

Press the Scroll button to proceed to the 'Goto' display.

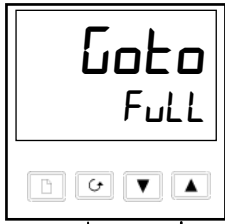
(If an *incorrect* password has been entered and the controller is still 'locked' then pressing *Scroll* at this point will simply return you to the *ACCS* list header.)

*Note:* From this *code* display, you can access "read only" configuration level by pressing  and  together.

To escape, press  and  together

### 3.2.3 Level Selection

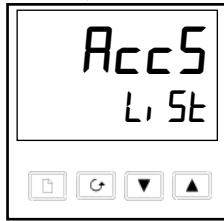
The 'Goto' display allows you to select the required access level.



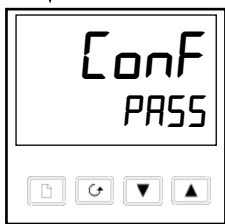
Use ▲ and ▼ to select from the following display codes:

- OPER: Operator level
- FULL: Full level
- Edit: Edit level
- CONF: Configuration level

Press the Scroll button



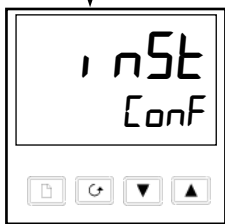
If you selected either 'OPER', 'FULL' or 'Edit' level you will be returned to the 'ACCESS list' header in the level that you chose. If you selected 'CONF', you will get an alternative display showing 'CONF' in the upper readout (see below).



### 3.2.4 Configuration password

When the 'CONF' display appears, you must enter the Configuration password in order to gain access to Configuration level. Do this by repeating the password entry procedure described in the previous section

The configuration password is set to '2' when the controller is shipped from the factory. If you need to change the configuration password, see section 5 Configuration.



### 3.2.5 Configuration level

Press the Scroll button

The first display of configuration is shown. See section 5, Configuration for details of the configuration parameters.

For instructions on leaving configuration level see section 5, Configuration.

### 3.2.6 To Return to Operator Level

To return to operator level from either 'FULL' or 'Edit' level, select 'OPER' on the 'Goto' display, or turn the controller off and on.

In 'Edit' level the controller will automatically return to operator level if no button is pressed for 45 seconds.

### 3.3 Edit Level

Edit level is used to set which parameters you can see and adjust in Operator level. It also gives access to the 'Promote' feature which allows you to select and add ('Promote') up to twelve parameters into the Home display list, thereby giving simple access to commonly used parameters.

#### 3.3.1 To Set Operator Access to a Parameter

First you must select *Edi t* level, as shown on the previous page.

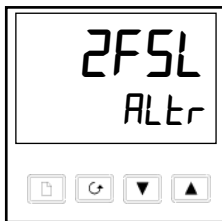
Once in *Edi t* level you select a list or a parameter within a list in the same way as you would in Operator or Full level. That is, you move from list header to list header by pressing the Page button, and from parameter to parameter within each list using the Scroll button. **However, in Edit level what is displayed is not the value of a selected parameter but a code representing the parameter's availability in Operator level.**

When you have selected the required parameter, use the  and  buttons to set its availability in operator level.

There are four codes:

- ALtEr* Makes a parameter alterable in Operator level
- PrO* Promotes a parameter into the Home display list
- rEAd* Makes a parameter or list header read-only (*it can be viewed but not altered*)
- Hi dE* Hides a parameter or list header.

For example:



The parameter selected is the set point for Alarm 2 - Full Scale Low

It will be alterable in Operator level

#### 3.3.2 To Hide or Reveal a Complete List

To hide a complete list of parameters, all you have to do is hide the list header. If a list header is selected only two selections are available: *rEAd* and *Hi dE*.

(It is not possible to hide the '*ACC5*' list which will always display the code: '*L1 5E*')

#### 3.3.3 To Promote a Parameter

Scroll through the lists to the required parameter and choose the '*PrO*' code. The parameter is then automatically added (promoted) into the Home display list (the parameter will also be accessible as normal from the standard lists. a maximum of 12 parameters can be promoted. Promoted parameters are automatically 'alterable'.



## 4 Tuning

### 4.1 What Is Tuning?

Before tuning please read section 2, *Operation*, to learn how to select and change a parameter.

In tuning you match the characteristics of the controller to that of the process being controlled in order to obtain good control. Good control means:

Stable 'straight-line' control of the temperature at setpoint without fluctuation

Acceptable overshoot or undershoot of the temperature setpoint

Quick response to deviations from the setpoint caused by external disturbances, thereby restoring the temperature rapidly to the setpoint value.

Tuning involves calculating and setting the value of the parameters listed in Table 4-1. These parameters appear in the *P, d* list.

Parameter	Code	Meaning or Function
Proportional band	$P_b$	The bandwidth in display units over which the output power is proportioned between minimum and maximum.
Integral time	$t_i$	Determines the time taken by the controller to remove steady-state error signals.
Derivative time	$t_d$	Determines how strongly the controller will react to the rate-of-change of the measured value.
Low cutback	$L_{cb}$	The number of display units below setpoint at which the controller will cutback the output power in order to prevent overshoot on heat up.
High Cutback	$H_{cb}$	The number of display units above setpoint at which the controller will increase the output power in order to prevent undershoot on cool down.
Relative cool gain	$r_{ELC}$	Only present if cooling has been configured. Sets the cooling proportional band by dividing the $P_b$ value by the $r_{ELC}$ value.

**Table 4-1: Tuning Parameters**

### 4.2 Automatic Tuning

This method automatically determines the value of the parameters listed in table 4-1 on the previous page.

The 2216e uses a 'one-shot' tuner which works by switching the output on and off to induce an oscillation in the measured value. From the amplitude and period of the oscillation, it calculates the tuning parameter values.

If the process cannot tolerate full heating or cooling being applied during tuning, then the level of heating or cooling can be restricted by setting the heating and cooling power limits in the Output list. However, the measured value *must* oscillate to some degree for the tuner to be able to calculate values

A One-shot Tune can be performed at any time but normally it is performed only once during the initial commissioning of the process. However, if the process under control subsequently becomes unstable (because its characteristics have changed), you can re-tune again for the new conditions.

It is best to start tuning with the process at ambient temperature. This allows the tuner to calculate more accurately the low cutback and high cutback values that restrict the amount of overshoot or undershoot.

#### 4.2.1 Heating and Cooling Output Cycle Times

Before commencing a tuning cycle, set the values of  $ELCH$  (heat cycle time) and  $ELCL$  (cool cycle time) in the op (output list). These values apply if you are using a logic, relay or triac output. They have no effect on a DC output.

A logic output switching a solid state relay can be set to values such as 1 sec.

A relay or triac output should be set to 20 sec.

### 4.3 How To Tune

Set the setpoint to the value at which you will normally operate the process.

In the 'Auto' list, select 'TUNE' and set it to 'ON'

Press the Page and Scroll buttons together to return to the Home display. The display will flash 'TUNE' to indicate that tuning is in progress.

The controller will induce an oscillation in the temperature by turning the heating on and then off. The first cycle will not complete until the measured value has reached the required setpoint.

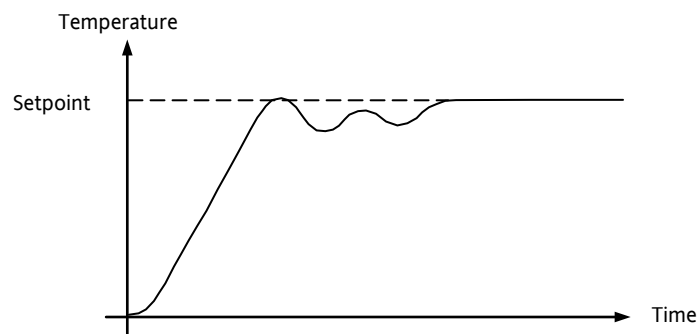
After two cycles of oscillation the tuning will be completed and the tuner will switch itself off.

The controller will then calculate the tuning parameters listed in Table 4-1 and will resume normal control action.

If you want 'Proportional only' or 'PD' or 'PI' control, you should set the 'P', 'D' or 'I' parameters to OFF before commencing the tuning cycle. The tuner will leave them off and will not calculate a value for them.

For valve position tuning and set-up, please refer to Section 4.

#### 4.3.1 Typical automatic tuning cycle



#### 4.3.2 Calculation of the cutback values

*Low cutback* and *High cutback* are values that restrict the amount of overshoot or undershoot that occur during large step changes in temperature (for example, under startup conditions).

If either low cutback or high cutback is set to 'Auto' the values will be fixed at three times the proportional band, and will not be changed during automatic tuning.



## 4.4 Manual Tuning

If for any reason automatic tuning gives unsatisfactory results, you can tune the controller manually. There are a number of standard methods for manual tuning. The one described here is the Ziegler-Nichols method.

With the process at its normal running temperature:

1. Set the Integral Time ' $t_i$ ' and the Derivative Time ' $t_d$ ' to OFF.
2. Set High Cutback and Low Cutback, ' $H_{cb}$ ' and ' $L_{cb}$ ', to 'Auto'.
3. Ignore the fact that the temperature may not settle precisely at the setpoint.
4. If the temperature is stable, reduce the proportional band ' $P_b$ ' so that the temperature just starts to oscillate. If the temperature is already oscillating, increase the proportional band until it just stops oscillating. Allow enough time between each adjustment for the loop to stabilise. Make a note of the proportional band value 'B' and the period of oscillation 'T'.
5. Set the  $P_b$ ,  $t_i$ ,  $t_d$  parameter values according to the calculations given in Table 4-2.

Type of control	Proportional band ' $P_b$ '	Integral time ' $t_i$ '	Derivative time ' $t_d$ '
Proportional only	$2 \times B$	OFF	OFF
P + I control	$2.2 \times B$	$0.8 \times T$	OFF
P + I + D control	$1.7 \times B$	$0.5 \times T$	$0.12 \times T$

Table 4-2: Tuning Values

### 4.4.1 Setting the cutback values

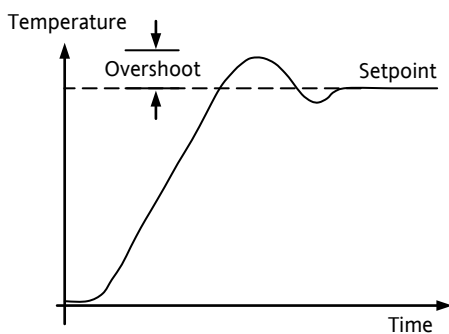
The above procedure sets up the parameters for optimum steady state control. If unacceptable levels of overshoot or undershoot occur during start-up or for large step changes in temperature, then manually set the cutback parameters  $L_{cb}$  and  $H_{cb}$ .

Proceed as follows:

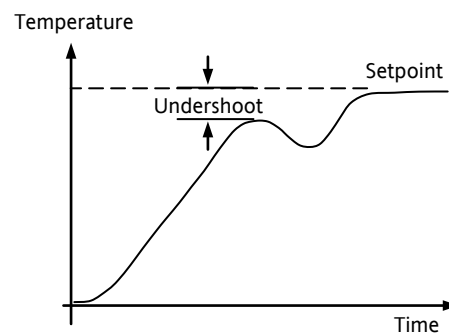
1. Set the low and high cutback values to three proportional bandwidths (that is to say,  $L_{cb} = H_{cb} = 3 \times P_b$ ).
2. Note the level of overshoot or undershoot that occurs for large temperature changes (see the diagrams below).

In example (a) increase  $L_{cb}$  by the overshoot value. In example (b) reduce  $L_{cb}$  by the undershoot value.

Example (a)



Example (b)



Where the temperature approaches setpoint from above, you can set  $H_{cb}$  in a similar manner.

#### 4.4.2 Integrating Action and Manual Reset

In a full three-term controller (that is, a PID controller), the integral term '*I*' automatically removes steady state errors from the setpoint. If the controller is set up to work in two-term mode (that is, PD mode), the integral term will be set to *OFF*. Under these conditions the measured value may not settle precisely at setpoint. When the integral term is set to *OFF* the parameter *manual reset* (code *RES*) appears in the *P, I, D, I, S, E* in '*FULL*' Access level. This parameter represents the value of the power output that will be delivered when the error is zero. You may set this value manually in order to remove the steady state error.

#### 4.4.3 Automatic Droop Compensation (Adc)

The steady state error from the setpoint, which occurs when the integral term is set to *OFF*, is sometimes referred to as 'droop'. *Adc* automatically calculates the manual reset value in order to remove this droop. To use this facility, you must first allow the temperature to stabilise. Then, in the autotune parameter list, you must set *Adc* to '*CALC*'. The controller will then calculate a new value for manual reset, and switch *Adc* to '*MAN*'.

*Adc* can be repeated as often as you require but between each adjustment you must allow time for the temperature to stabilise.

## 5 Configuration

### WARNING



Configuration is protected and should only be carried out by an authorised person. Incorrect configuration could result in damage to the process being controlled and/or personal injury. It is the responsibility of the person commissioning the instrument to ensure that the configuration is correct.



Whenever the configuration menus are displayed or accessed all controller outputs are held at the power off state and control operation is suspended until exiting from configuration.

### 5.1 To Select Configuration Level

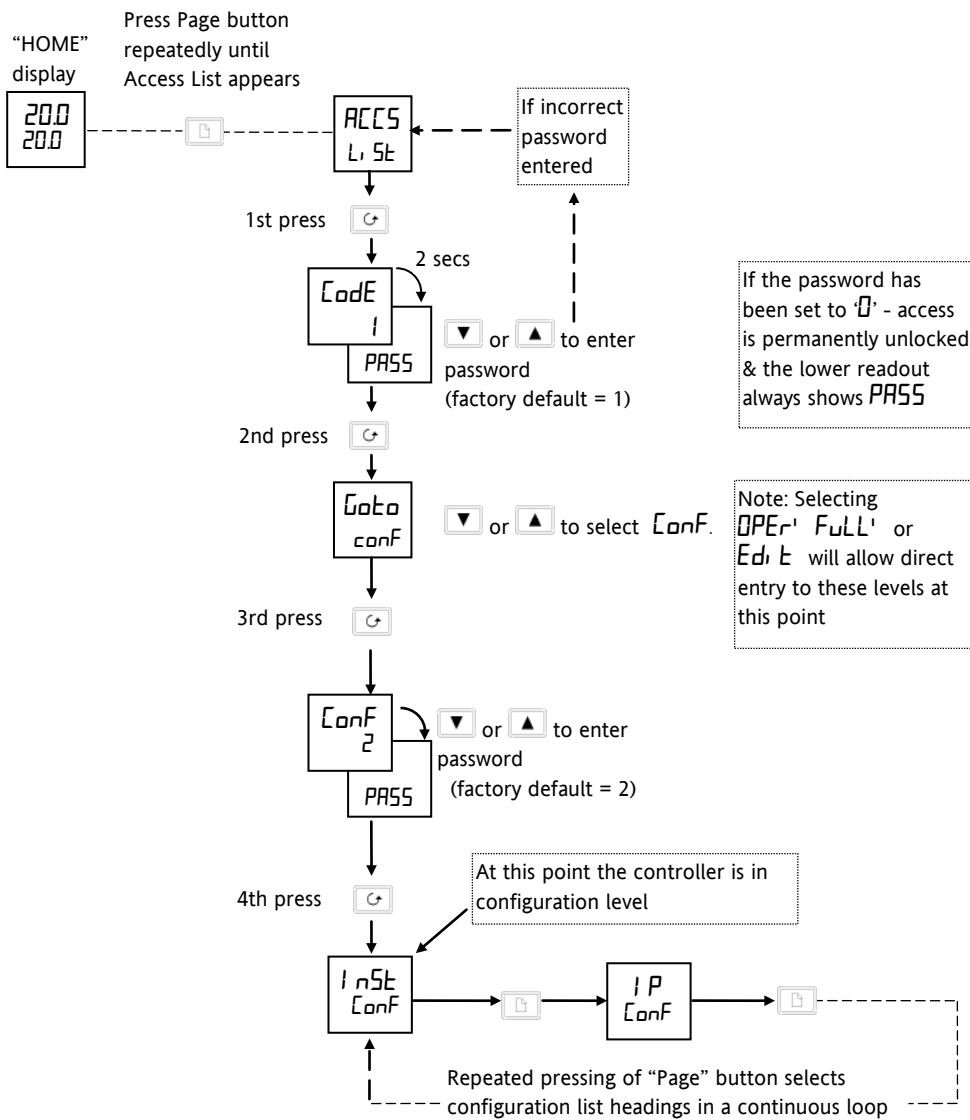


Figure 5-1: Selecting Configuration Level

### 5.2 To Select a Configuration Parameter

(continued from previous page)

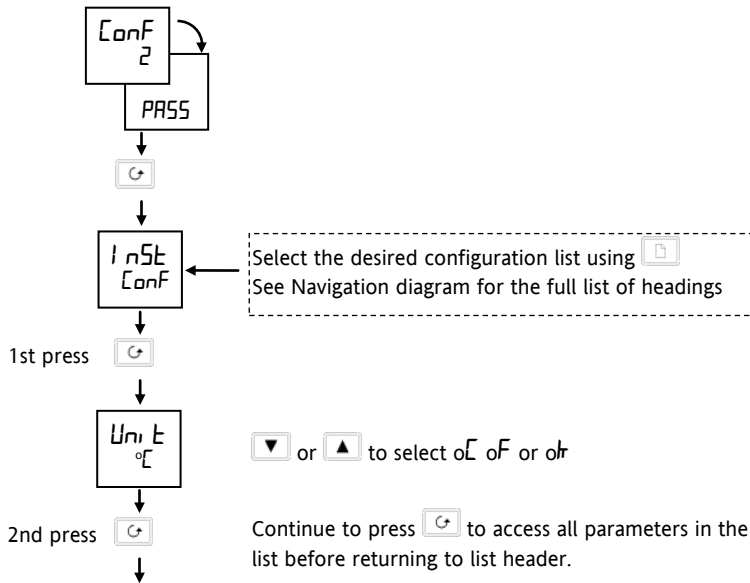


Figure 5-2: Selecting a Parameter

### 5.3 To Leave Configuration Level

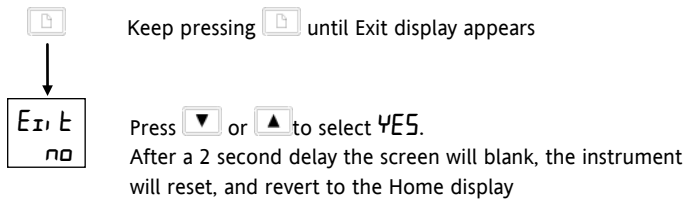


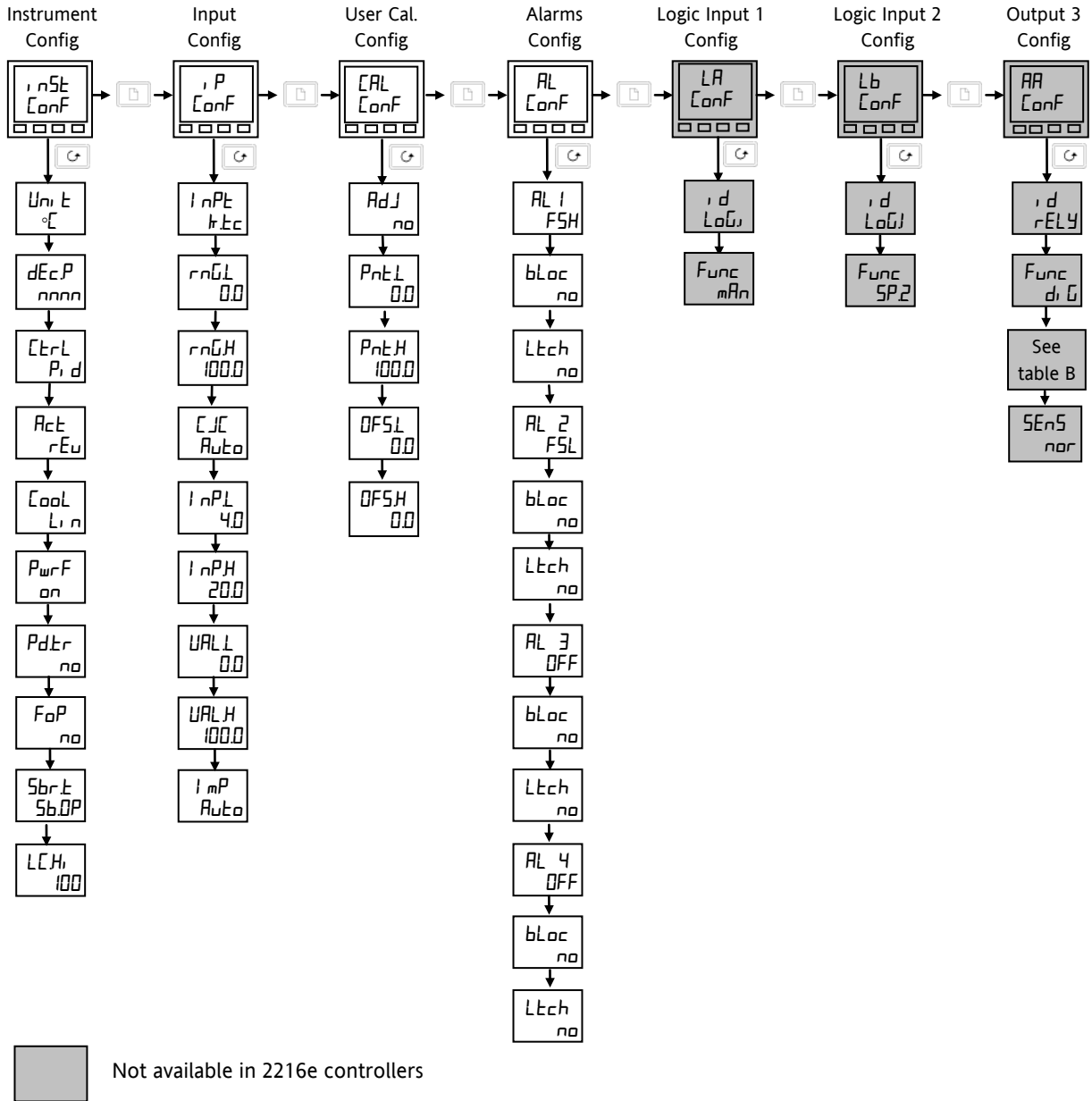
Figure 5-3: Leaving Configuration Level

### 5.4 Steps Involved In Configuring A Controller

The navigation diagram which follows shows the general location of parameters which define the way in which the controller works. They are grouped under headings.

The actual parameters shown in your controller may differ slightly since some appear only as a result of selecting others. A full list of possibilities is included in the PARAMETER TABLES which follow the navigation diagram.

5.5 Navigation Diagram (PART A)



**Summary**

**Step through List Headers**  
using the 'Page' button

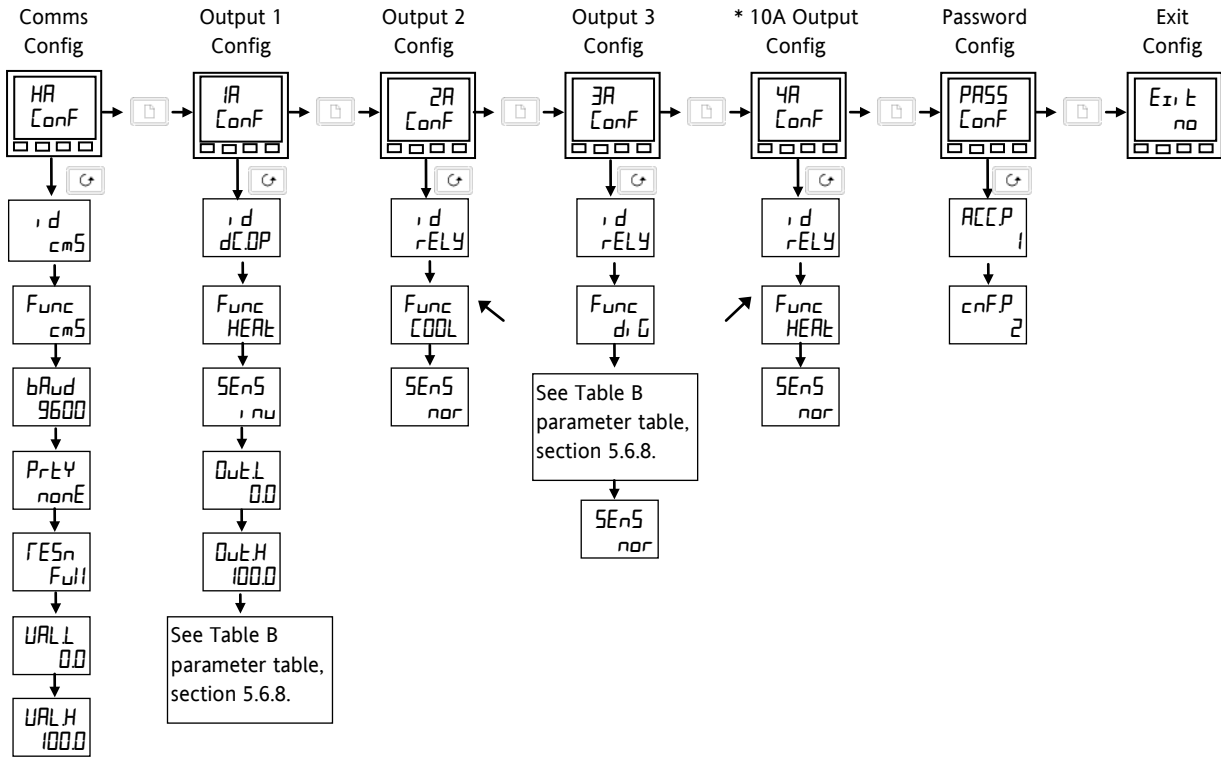
**Choose a parameter from a list**  
using the 'Scroll' button

**Change value**  
using the 'Raise/Lower' buttons or

The first four headings set up the controller functions, as follows:

- Instrument Config.** - Groups those parameters associated with the display and control action.
- Input Config.** - selects the input sensor type
- User cal. Config.** - to calibrate to external reference sources
- Alarms Config.** - sets up the alarm types

**Navigation Diagram (Part B)**



\* The 10Amp output option (4A) was available on 2404e controllers only until 01 Jan 04. It is not available in 2216e and 2208e controllers.

**Figure 5-4: Navigation Diagram**

## 5.6 Configuration Parameter Tables

Heading	Input/Output Functions	Wiring Terminals
The first four headings set up the controller functions as follows:		
<i>Inst Conf</i>	Sets up display and control parameters	Not applicable
<i>IP Conf</i>	Selects the input sensor type	Not applicable
<i>CAL Conf</i>	To calibrate to external reference sources	Not applicable
<i>AL Conf</i>	Sets up the alarm types	Not applicable
The remaining headings configure the controller input/output functions. The upper readout corresponds to rear terminal numbers associated with a particular i/o.		
<i>LA Lb Conf</i>	Sets up the action of the two digital inputs - not 2216e.	LA & LB
<i>RA Conf</i>	Sets up the action of the fixed relay on output AA - not 2216e.	AA to AC
<i>HA Conf</i>	Sets up digital comms type	HB to HF
<i>1A 2A Conf</i>	Sets up the output modules 1A and 2A	1A & 1B / 2A & 2B
<i>3A Conf</i>	Sets up the action of the fixed relay on output 3A - not 2216e.	3A to 3C
<i>4A Conf</i>	Sets the action of the 10A output relay in 2204e only (until Jan 04).	4A to 6D
<i>PASS Conf</i>	To choose new passwords	
<i>Exit no/YES</i>	To leave configuration level and return to operator level	

☺ Tip: Factory default parameter values and states are included where applicable and are indicated by the shaded areas in the following tables.

### 5.6.1 Instrument Configuration

Name	Parameter description	Values	Meaning
<i>Inst</i>	Instrument configuration		
<i>units</i>	Instrument units	°C °F °K none	Centigrade (default UK) Fahrenheit (default USA) Kelvin Units are not displayed
<i>decP</i>	Decimal places in the displayed value	none one two	None One Two
<i>Ctrl</i>	Control type	on/off PID VP	On/off control PID control Boundless VP Control (no feedback pot required)
<i>Act</i>	Control action	rev dir	Reverse acting (required for temperature control) - output decreases on approach to SP Direct acting
<i>cool</i>	Type of cooling	Lin oil H2O Fan	Linear Oil (50mS min on time) Water(non-linear) Fan (0.5S min on time)
<i>PowerF</i>	Power feedback	on off	Power feedback is on (compensates for changes in supply voltage) Power feedback is off
<i>PDtr</i>	Bumpless manual/auto transfer when using PD control	no yes	Non-bumpless transfer Bumpless transfer (auto to manual and manual to auto)
<i>ForP</i>	Forced manual output	no yes	Bumpless manual/auto transfer Returns to the manual value last set in manual mode.
<i>Sbrk</i>	Sensor break output	sbop hold	Go to pre-set value (maintains output at a known, safe level) Freeze output (maintains output at value immediately before break)
<i>LCH</i>	Load Current Scaling Factor	100	See section 9.10.

5.6.2 Input Configuration

Name	Parameter description	Values	Meaning
<b>IP</b>	<b>Input configuration</b>		
<b>IPt</b>	Input type  NOTE: <i>After selecting an input type, do not forget to adjust the setpoint limits in Full Access level.</i>	<b>Jtc</b> <b>Ktc</b> <b>Ltc</b> <b>Rtc</b> <b>Btc</b> <b>Ntc</b> <b>Ttc</b> <b>Stc</b> <b>PL2</b> <b>rtd</b> <b>Ctc</b> <b>mV</b> <b>volt</b>	J thermocouple (default USA) K thermocouple (default UK) L thermocouple R thermocouple (Pt/Pt13%Rh) B thermocouple (Pt30%Rh/Pt6%Rh) N thermocouple T thermocouple S thermocouple (Pt/Pt10%Rh) PL 2 thermocouple 100Ω platinum resistance thermometer. Custom downloaded input type. The default is C thermocouple, or the name of the downloaded custom input will be displayed. Linear millivolt (Also mA input via an external 2.49Ω current sense resistor) Linear voltage
<b>rnl</b>	Input range low		Display low range for input
<b>rnh</b>	Input range high		Display high range for input
<b>CJC</b>	CJC ref. temperature <i>(CJC does not appear for linear inputs)</i>	<b>Auto</b> <b>0° C</b> <b>45° C</b> <b>50° C</b>	Automatic cold junction compensation 0°C external reference 45°C external reference 50°C external reference
Linear Input Scaling - The next 4 parameters only appear if a linear input is chosen			
<b>IPL</b> <b>IPH</b> <b>URLL</b> <b>URLH</b>			Input value low Input value high Displayed reading low Displayed reading high
<b>IMP</b>	Sensor break input impedance trip level	<b>OFF</b> <b>Auto</b> <b>H</b> <b>H, H</b>	Sensor break detection is disabled. <i>Appears for mV or V inputs only</i> Trip level set by the sensor input table Trip level set at 7.5KΩ Trip level set at 15KΩ (must be selected when <b>volt</b> input is enabled)

5.6.3 Calibration Configuration

<b>CAL</b>	User calibration config.		See section 6 - User calibration
<b>AdJ</b>	User cal enable	<b>no</b> <b>YES</b>	User calibration is disabled User calibration is enabled
<b>PntL</b>	User calibration point low	<b>0</b>	This is the value (in display units) at which a User last performed a low point calibration
<b>PntH</b>	User calibration point high	<b>100</b>	This is the value (in display units) at which a User last performed a high point calibration
<b>OFFSL</b>	Low point calibration offset	<b>0</b>	Offset, in display units, at the user low calibration point 'Pnt.L'. This value is automatically calculated when performing low point calibration.
<b>OFFSH</b>	High point calibration offset	<b>0</b>	Offset, in display units, at the user high calibration point 'Pnt.H'. This value is automatically calculated when performing a high point calibration.

If User calibration is enabled, then the User calibration parameters will appear in the Input list of Operator Full access level. See section 6, *User calibration*.



### 5.6.4 Alarm Configuration

<i>AL</i>	Alarm configuration	Values	Defaults if not specified
<i>AL1</i>	Alarm 1 Type	As table A	<i>OFF</i>
<i>bLoc</i>	Alarm 1 Blocking <sup>(1)</sup>	<i>no/YES</i>	<i>no</i>
<i>Ltch</i>	Alarm 1 Latching	<i>no/Auto/mAn/EuE</i>	<i>no</i>
<i>AL2</i>	Alarm 2 Type	As table A	<i>OFF</i>
<i>bLoc</i>	Alarm 2 Blocking <sup>(1)</sup>	<i>no/YES</i>	<i>no</i>
<i>Ltch</i>	Alarm 2 Latching	<i>no/Auto/mAn/EuE</i>	<i>no</i>
<i>AL3</i>	Alarm 3 Type	As table A	<i>OFF</i>
<i>bLoc</i>	Alarm 3 Blocking <sup>(1)</sup>	<i>no/YES</i>	<i>no</i>
<i>Ltch</i>	Alarm 3 Latching	<i>no/Auto/mAn/EuE</i>	<i>no</i>
<i>AL4</i>	Alarm 4 Type	As table A	<i>OFF</i>
<i>bLoc</i>	Alarm 4 Blocking <sup>(1)</sup>	<i>no/YES</i>	<i>no</i>
<i>Ltch</i>	Alarm 4 Latching	<i>no/Auto/mAn/EuE</i>	<i>no</i>
<b>Table A: Alarm types</b>			
<i>OFF</i>	No alarm		
<i>FSL</i>	Full scale low		
<i>FSH</i>	Full scale high		
<i>dEu</i>	Deviation band		
<i>dHi</i>	Deviation high		
<i>dLo</i>	Deviation low		
<i>Lcr</i>	Low current		
<i>Hcr</i>	High current		

(1) Blocking allows the alarm to become active only after it has first entered a safe state.

☺ Tip: These are 'soft' alarms, i.e. Indication only. They would normally be attached to an output. See section 7 'Alarm Configuration' for a step by step guide.

### 5.6.5 Logic Inputs Configuration - 2208e and 2408e only.

<i>LA</i>	Logic input 1 configuration	Functions	Action on contact closure
<i>id</i>	Identity of input	<i>LoUj</i>	Logic input
<i>Func</i>	Function	<i>nonE</i>	None
		<i>mAn</i>	Manual mode select
		<i>rmt</i>	Remote setpoint select
		<i>SP2</i>	Setpoint 2 select
		<i>ti H</i>	Integral hold
		<i>AcAL</i>	Acknowledge alarms
		<i>Loc.b</i>	Lock Key pad
		<i>rSEt</i>	Reset
		<i>StBY</i>	Standby - ALL outputs = OFF
		<i>AmPS</i>	PDS load current input

<i>Lb</i>	Logic input 2 configuration	Functions	Action on contact closure
As per Logic input 1 except ' <i>AmPS</i> ' not available			

**5.6.6 AA Alarm Relay Configuration - 2208e and 2408e only**

RR	Alarm relay configuration	Functions	Meaning
<i>id</i>	Identity of output	<i>RELY</i>	Relay
<i>Func</i>	Function	<i>none</i> <i>di G</i> <i>HEAT</i> <i>COOL</i>	None Function set by <i>di GF</i> (as in Table B) Heating Cooling
For <i>Function = di G</i> go to table B on the next page			
<i>SENS</i>	Sense of output (always appears)	<i>nor</i> <i>inv</i>	Normal ( <i>heat &amp; cool outputs</i> ) Inverted ( <i>alarms de-energised in the alarm state</i> )



**5.6.7 Digital Communications Configuration**

HR	Comms module config	Functions	Meaning
<i>id</i>	Identity of the option installed	<i>PDS</i> , <i>cmS</i>	PDS setpoint input 2- or 4-wire EIA-485 (422) or EIA-232 comms module
<i>Func</i>	Function		
<i>Some of the following parameters may appear if one of the comms options is installed</i>			
		<i>cmS</i> <i>none</i>	DIGITAL Communication protocol ordered (ModBus, ElBisynch or DeviceNet) None
<i>The following parameters will appear if the PDSIO setpoint input option is installed.</i>			
		<i>none</i> <i>SP, P</i>	No PDS function PDS setpoint input
<i>LRLL</i>	PDS low input value	Range = -999 to 9999	
<i>LRHH</i>	PDS high input value	Range = -999 to 9999	
<i>The following parameters will appear if, <i>d = cmS</i></i>			
<i>BRud</i>	Baud Rate - ElBisynch	2400, 4800, 9600, 19.20, 1920 (19200)	
<i>BRud</i>	Baud Rate - ModBus	1200, 2400, 4800, 9600, 19.20, 1920 (19200)	
<i>BRud</i>	Baud Rate - DeviceNet	125(K), 250(K), 500(K)	
<i>PRty</i> <sup>(1)</sup>	Comms Parity	<i>none</i> <i>Even</i> <i>Odd</i>	No parity Even parity Odd parity
<i>RESn</i> <sup>(1)</sup>	Comms Resolution	<i>FULL</i> <i>int</i>	Full resolution Integer resolution

Note 1: Not used with some communication protocols. Please consult factory.

**5.6.8 Output 1 Configuration**

<i>id</i>	Output 1 configuration	Function	Meaning
<i>id</i>	Identity of module installed	<i>nonE</i> <i>RELy</i> <i>dC.OP</i> <i>LoG</i> <i>SSr</i>	No module fitted Relay output DC output (isolated) Logic or PDS output Triac output
<i>Func</i>	Function  <i>Only appear for id = dC.OP</i> <i>Only appear for id = dC.OP</i> <i>Only appear for id = dC.OP</i> <i>Only appear for id = dC.OP</i> <i>Only appear for id = LoG</i> <i>Only appear for id = LoG</i>	<i>nonE</i> <i>di G</i> <i>HEAT</i> <i>COOL</i> <i>OP</i> <i>PU</i> <i>Err</i> <i>wSP</i> <i>SSr.1</i> <i>SSr.2</i>	Module does not operate Function set by <i>di GF</i> Heating output Cooling output Retransmission of output demand Retransmission of Process Value Retransmission of error Retransmission of setpoint PDS mode 1 heating PDS mode 2 heating
For <i>Function = di G</i> (refer to table B on page 5-14)			
<i>SENS</i>	Sense of output	<i>nor</i> <i>inv</i>	Normal (e.g.heating and cooling) Inverted (alarms - de-energise in alarm)
DC output scaling For <i>id = dC.OP</i> the following parameters appear			
<i>OutL</i>	DC output minimum	0mA to <i>OutH</i> or 20mA	
<i>OutH</i>	DC output maximum	<i>OutL</i> or 0mA to 20mA	

<b>Table B</b> The following parameters appear if ' <i>di G</i> ' is chosen as the function.			
<i>di GF</i>	Digital output functions Any number of the functions listed can be combined on to the output. Use the  and  buttons to select a desired digital function. After two seconds the display will blink and return to the 'nach' display. Use the arrows again to scroll through the function list. The previously selected function display will show two decimal points indicating that it has been added to the output.	<i>nach</i> <i>clr</i> <i>1 - - - *</i> <i>2 - - - *</i> <i>3 - - - *</i> <i>4 - - - *</i> <i>mAn</i> <i>Sbr</i> <i>Lbr</i> <i>HtrF</i> <i>LdF</i> <i>ENd</i> <i>SPAn</i> <i>SSrF</i> <i>nwAL</i> <i>rmtF</i> <i>CT.OP</i> <i>CT.Sh</i>	No change Clear all existing functions Alarm 1 * Alarm 2 * Alarm 3 * Alarm 4 * Manual/Auto Sensor Break Loop Break Heater Fail Load Fail END Program PV Out of Range PDS® SSR Failure New Alarm Remote Sp Fail CTx open circuit CTx short circuit

\* From previous page. In place of the dashes, the last three characters indicate the alarm type as per table A in the AL list: eg *IFSL* = Full Scale Low.

If an alarm is not configured the displayed name will differ: e.g. '*AL 1*' will be shown, for the first alarm.

**5.6.9 Output 2 Configuration**

<b>2A</b>	<b>Output 2 configuration</b>	<b>Function</b>	<b>Meaning</b>
<b>id</b>	Identity of module installed	<i>none</i>	No module fitted
		<i>REL</i>	Relay output
		<i>LOG</i>	Logic
		<i>SSr</i>	Triac output
<b>Func</b>	Function	<i>none</i>	none
	Outputs	<i>di G</i>	Function set by <i>di GF</i>
		<i>HEAT</i> <i>COOL</i>	Heating output Cooling output
Logic Inputs	<i>mAn</i>	Manual mode select	
	<i>rmE</i>	Remote setpoint select	
	<i>SP2</i>	Setpoint 2 select	
	<i>EH</i>	Integral hold	
	<i>ACKAL</i>	Acknowledge alarms	
	<i>LOCKb</i>	Lock Key pad	
	<i>RESET</i>	Reset	
	<i>STBY</i>	Standby - ALL outputs = OFF	
	<i>AMP5</i>	PDS load current input	
For <b>Func = di G</b> (Refer to table B).			
<b>SENS</b>	Sense of output	<i>nor</i>	Normal ( <i>heat and cool outputs</i> )
		<i>inv</i>	Inverted ( <i>alarms - de-energise in alarm</i> )

**5.6.10 Output 3 Configuration**

<b>3A</b>	Output 3 configuration	As per output 2A configuration
-----------	------------------------	--------------------------------

**5.6.11 Output 4 Configuration**

<b>4A</b>	10Amp heating output	Available on 2204e only.
As per Output 3A configuration		
<b>Note: The 10Amp output option is not available on controllers from 01 Jan 04</b>		

**5.6.12 Password Configuration**

<b>PASS</b>	Password list
<b>ACCP</b>	FuLL or Edit level password
<b>cnFP</b>	Configuration level Password

**Note:-** When passwords are changed please make a note of the new numbers

**5.6.13 Exit Configuration**

<b>EXIT</b>	Exit Configuration	<i>no/YES</i>
-------------	--------------------	---------------

## 5.7 Configuration of Digital Communications

2200e series controllers can be fitted with the following digital communications modules:-

Protocol	Module Fitted	Order Code
ModBus	2-wire EIA485	2YM
	4-wire EIA 422	2FM
	EIA 232	2AM
EI-Bisynch	2-wire EIA 485	2YE
	4-wire EIA 422	2FE
	EIA 232	2AE
DeviceNet		2DN



**Warning.** The 2200 series has a limited number of writes to EEPROM. Please ensure that parameters which do not require updating on a regular basis (for example, setpoints, alarm trip levels, hysteresis, etc) are only written to when a change in the parameter value occurs. Failure to do this could result in permanent damage to the internal EEPROM. Alternatively, a special version (EU0555-2200) can be supplied with specific handling to allow the working setpoint to be changed over digital communications without being written to eeprom.

### 5.7.1 To Configure the Function, and Baud Rate

All devices on a network must have the same Baud Rate, Parity and Resolution.

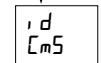


Comms configuration list - HA



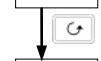
#### Identity of module

This is a read-only parameter displaying the identity of the module fitted



#### Function

Set  $FUNC = CM5$  to select the protocol. Ensure that the correct Comms module has been fitted. To disable comms set  $FUNC$  to  $none$ .



#### Baud Rate

Press  $\uparrow$  or  $\downarrow$  to set the Baud Rate. The choices are:-  
 1200, 2400, 4800, 9600, 19,200 for Modbus  
 2400, 4800, 9600, 19,200 for EI-Bisynch  
 125(K), 250(K), or 500(K) for DeviceNet

Parity and Resolution can be set by the same procedure. These will normally be set to None and Full respectively

### 5.7.2 To Set Instrument Address

All devices on a network must have a different node address.

Instrument address is set in Full operator level.

Exit configuration level. This is described in section 5.3.



#### Comms list

From the HOME display, press the Page button until you reach the  $CM5$  list



#### Address

Press the raise or lower buttons until the desired address is set. The choices are:-  
 0 to 99 for Modbus and EI-Bisynch  
 0 to 64 for DeviceNet.

## **5.8 DeviceNet**

The following is applicable to DeviceNet only.

### **5.8.1 The EDS File**

The EDS (Electronic Data Sheet) file for the Series 2200e is named 2K2DN.EDS and is available from your supplier, or electronically by going to Web site (<http://www.eurotherm.com/downloads/software/?assetdet1390258=2854&p=19>). The EDS file is designed to automate the DeviceNet network configuration process by precisely defining vendor-specific and required device parameter information. Following a data sheet metaphor, the EDS file describes a device's configurable parameters, including its legal and default values and the public interfaces to those parameters. Software configuration tools utilize the EDS files to configure a DeviceNet network.

### **5.8.2 ODVA Compliance**

This interface has been tested to comply with the full requirements of the ODVA (Open DeviceNet Vendors Association) conformity tests.

## 6 User Calibration

This section has five topics:

- WHAT IS THE PURPOSE OF USER CALIBRATION?
- USER CALIBRATION ENABLE
- SINGLE POINT CALIBRATION
- TWO POINT CALIBRATION
- CALIBRATION POINTS AND CALIBRATION OFFSETS

To understand how to select and change parameters in this section you will need to have read Section 2 - *Operation*, Section 3 - *Access Levels* and Section 5 - *Configuration*.

### 6.1 What is the Purpose of User Calibration?

The basic calibration of the controller is highly stable and set for life. User calibration allows you to offset the 'permanent' factory calibration to either:

1. Calibrate the controller to your reference standards
2. Match the calibration of the controller to that of a particular transducer or sensor input
3. Calibrate the controller to suit the characteristics of a particular installation.

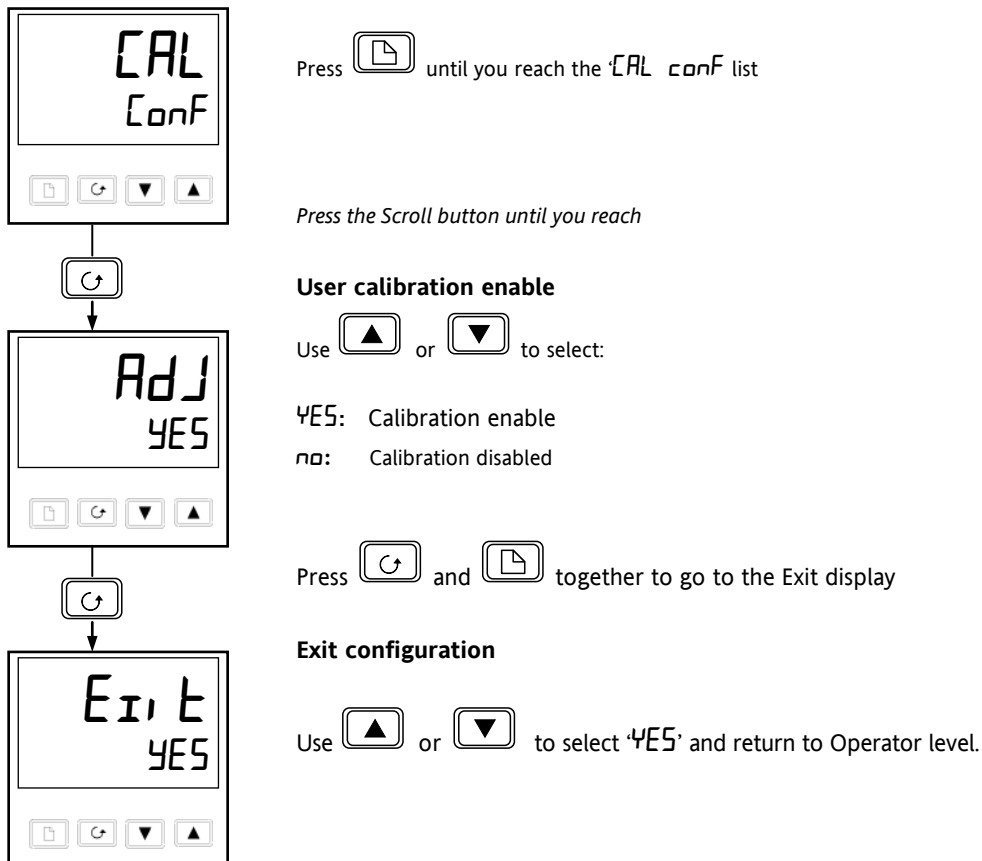
User calibration works by introducing zero and span offsets onto the factory set calibration. The factory set calibration can always be retrieved.

### 6.2 User Calibration Enable

The User calibration facility must first be enabled in configuration level by setting the parameter 'Adj' in the *CAL CONF* list to 'YES'. This will make the User calibration parameters appear in Operator 'FULL' level.

Select configuration level as shown in section 5, *Configuration*.

#### 6.2.1 The User calibration configuration List



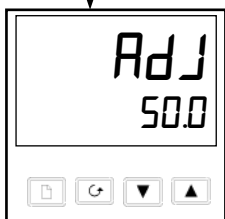
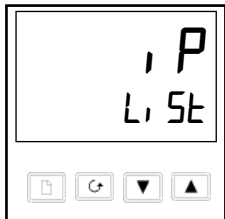
### 6.3 Single Point Calibration

Your controller is calibrated for life against known reference sources during manufacture. A calibration offset is often used to allow the controller to compensate for sensor and other system errors. The normal procedure is to set up the system under test against a known independent reference, as follows:


Set up the process to be calibrated such that the known reference displays the required value (temperature).

Observe the reading on the controller. If it is different, proceed as follows:

Select **FULL** Access level as described in section 3 *Access levels*.





**Input list header**

Press  until you reach the input list header.

Press *Scroll* until you reach the 'CAL' display

**Calibration type**

Use  or  to select either 'FACT' or 'USER'.

Selecting 'FACT' will reinstate the factory calibration and hide the following User calibration parameters.

Selecting 'USER' will reinstate any previously set User calibration and make available the User parameters, as follows:

Press the *Scroll* button

**Calibrate low point?**



Use  or  to select 'YES'

Selecting 'no' will hide the next parameter

Press the *Scroll* button

**Adjust the low point calibration**

The controller will display the current measured input value in the lower readout.

Use  or  to adjust the reading to the reference source value, if different.

After a two second delay the display will blink and the reading will change to the new, calibrated value. You can calibrate at any point over the entire display range

This is a single point calibration which applies a fixed offset over the full display range of the controller.

The calibration is now complete. You can return to the factory calibration at any time by select 'FACT' in the CAL display shown earlier.

Press  and  together to return to the Home display

To protect the calibration against unauthorised adjustment return to Operator level and make sure that the calibration parameters are hidden. Parameters are hidden using the 'Edt' facility described in section 3.3.

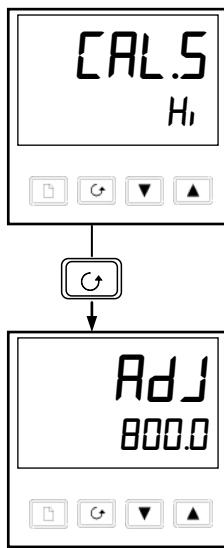


### 6.4 Two Point Calibration

The previous section described how to perform a single point calibration which applies a fixed offset over the full display range of the controller. A two-point calibration is used to calibrate the controller at two points and apply a straight line between them. Any readings above or below the two calibration points will be an extension of this straight line. For this reason it is best to calibrate with the two points as far apart as possible.

Proceed as follows:

1. Decide upon the low and high points at which you wish to calibrate.
2. Perform a single point calibration at the low calibration point in the manner described above
3. Set the process under calibration such that the known reference exhibits the required higher Process Value (temperature) and allow to stabilize.
4. Press the Scroll button to obtain the high calibration point as shown in the following diagrams.





#### Calibrate high point?

Use  or  to select 'Hi'.

Press the Scroll button



#### Adjust the high point calibration

The controller will display the current measured input value in the lower readout.

Use  or  to adjust the reading to the reference source value, if different.

After a two second delay the display will blink and the reading will change to the new, calibrated value.

The calibration is now complete. You can return to the factory calibration at any time by select 'FACT' in the CAL display shown earlier.

Press  and  together to return to the Home display

To protect the calibration against unauthorised adjustment return to Operator level and make sure that the calibration parameters are hidden. Parameters are hidden using the 'Edit' facility described in section 3.3.

### 6.5 Calibration Points and Calibration Offsets

If you wish to see the points at which the User calibration was performed and the value of the offsets introduced these are shown in Configuration, under CAL CONF. The parameters are:

Name	Parameter description	Meaning
PnEL	User low calibration point	This is the value (in display units) at which a User last performed an 'ADJL' (adjust low calibration).
PnEH	User high calibration point	This is the value (in display units) at which a User last performed an 'ADJH' (adjust high calibration).
OFFSL	Low point calibration offset	Offset, in display units, at the user low calibration point 'PnEL'
OFFSH	High point calibration offset	Offset, in display units, at the user high calibration point 'PnEH'.



## 7 Alarm Configuration

The 2200e series controllers are capable of very sophisticated alarm strategies and, although setting up of alarms has already been covered in previous sections, this section has been included to enable operators and commissioning engineers to design their own strategies for optimum plant operation.

### 7.1 Definition Of Alarms And Events

See also section 2.10 for further information on Alarms.

**Alarms** are used to alert an operator when a pre-set level or condition has been exceeded. They are normally used to switch an output - usually a relay - to provide interlocking of the machine or plant or external audio or visual indication of the condition.

**Soft Alarms** are indication only within the controller and are not attached to an output (relay).

**Events** - can also be alarms - but are generally defined as conditions which occur as part of the normal operation of the process. They do not generally require operator intervention.

Events are referred to as **Digital Output Functions** in the manual (see Table B, section 5.6.8).

For the purposes of the operation of this instrument alarms and events can be considered the same.

#### 7.1.1 Types of Alarms

The use of alarms in the 2200e series controllers is extremely versatile.

Up to 4 alarms can be configured. Any combination of these 4 alarms can be attached to any one or more outputs, or any number of the available "soft" alarms can be combined to operate a single output.



Note: In a three term controller at least one of these outputs is used to maintain the required temperature of the process.

Outputs 1A and 2A	Are plug in modules. Normally used for control outputs, eg. Heat and Cool, but can be used for alarm outputs.
Outputs AA (2208e & 2204e only) and 3A	Are fixed relays. Normally used for alarms or events, but can be used as control outputs.
10A Output 4A (2204e only)	Is a plug in 10 Amp relay output. Normally used to switch heaters directly in control mode, but can be used as an alarm output.

**Note:- This option is not available on controllers after Jan-04**

There are seven process alarm types listed below. Alarm Types are found in configuration mode under the Alarm Config. List.

## ALARMS

- Full Scale High** The PV exceeds a set high level
- Full Scale Low** The PV exceeds a set low level
- Deviation Band** The difference between PV & SP is outside a set band
- Deviation High** The difference between PV & SP is higher than a set level
- Deviation Low** The difference between PV & SP is lower than a set level
- High Current** The measured current returned from a PDS slave is higher than a set level. See also section 9.
- Low Current** The measured current returned from a PDS slave is lower than a set level. See also section 9.

Each **alarm** can be set to:

- Latching** Alarm is indicated until acknowledged (Off, Auto, MAN)
  - Auto Acknowledge: (Llch Auto)**  
If the alarm is acknowledged while the alarm condition is still present, it will cause the alarm to reset as soon as the alarm condition is removed.
  - Manual Acknowledge: (Llch mAn)**  
If the alarm is acknowledged while the alarm condition is still present, it will be ignored. A further acknowledgement is required when the alarm condition has been removed to cause the alarm to reset.
- Blocking** Alarm occurs **after** it has been through a start up phase **not** in alarm condition.
- Sense Of Output** Relay energised or de-energised in alarm condition. See also sections 2.11 and 7.3.
- Soft Alarms** Indication only and do not operate an output.

See also Section 2.10.1 for further information on alarm types.

## 7.2 Digital Output Functions

In addition there are nine “digital output functions” used as events or alarms depending upon the requirements of the process under control:

- Sensor Break** The input is open circuit
- Loop Break** The controller does not measure a response to an output change
- Load Failure** Used with PDS Mode 1 load failure. See also section 9.
- Manual** Controller in manual mode
- PV Out Of Range** Process Variable too high or too low
- Remote SP Fail** No signal measured at the remote set point input terminals
- Heater Fail** Used with PDS Mode 2 heater open circuit. See also section 9.
- SSR Fail** Used with PDS Mode 2 solid state relay open or short circuit. See also section 9.
- Program END** Signals the end of a program
- New Alarm** Signals a new alarm



The **Sense of the Output** can be set to relay energised or de-energised in the alarm condition for any of the above functions.

### 7.3 Step1 - To Configure the Four 'Soft' Alarms

Soft alarms are indication only and do not operate a relay

Go To Configuration Level - Refer to section 5.

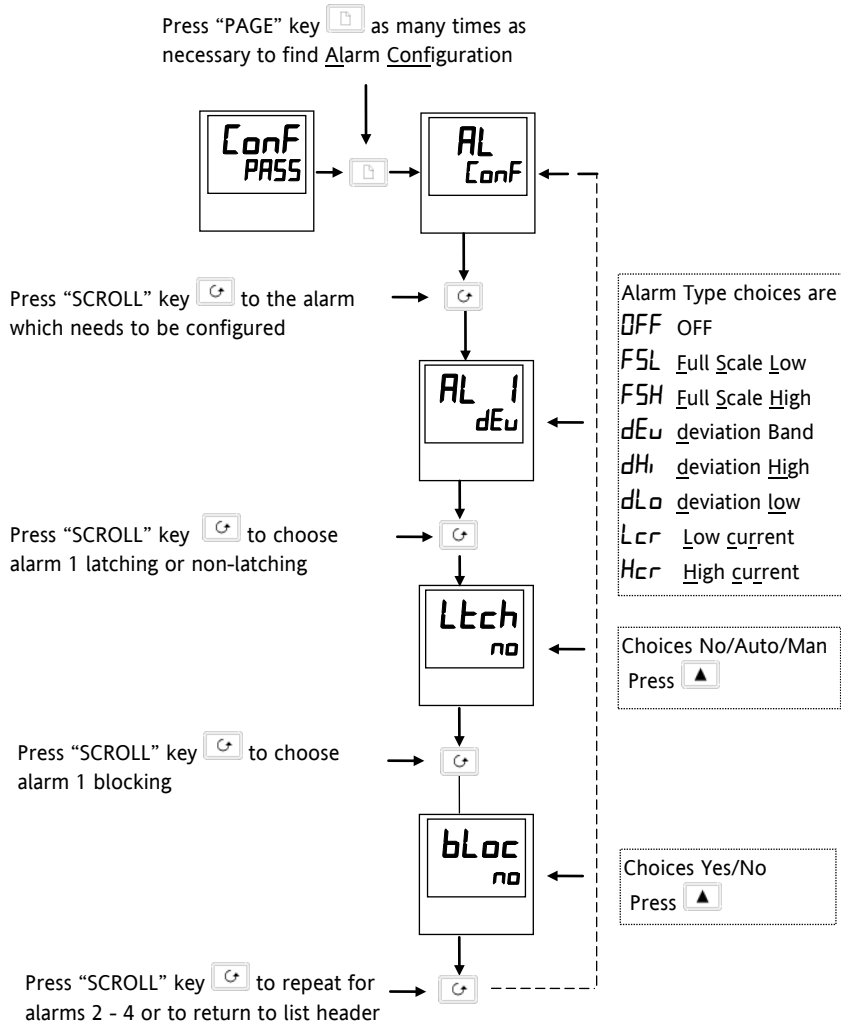



Figure 7-1: Configuring 'Soft' Alarms

### 7.4 Step 2 - To Attach an Alarm to A Physical Output

This may be necessary if:

1. The instrument has been supplied un-configured or it is required to re-configure.
2. Alarm relays are added.

Press "PAGE" key  as many times as necessary to find AA Configuration

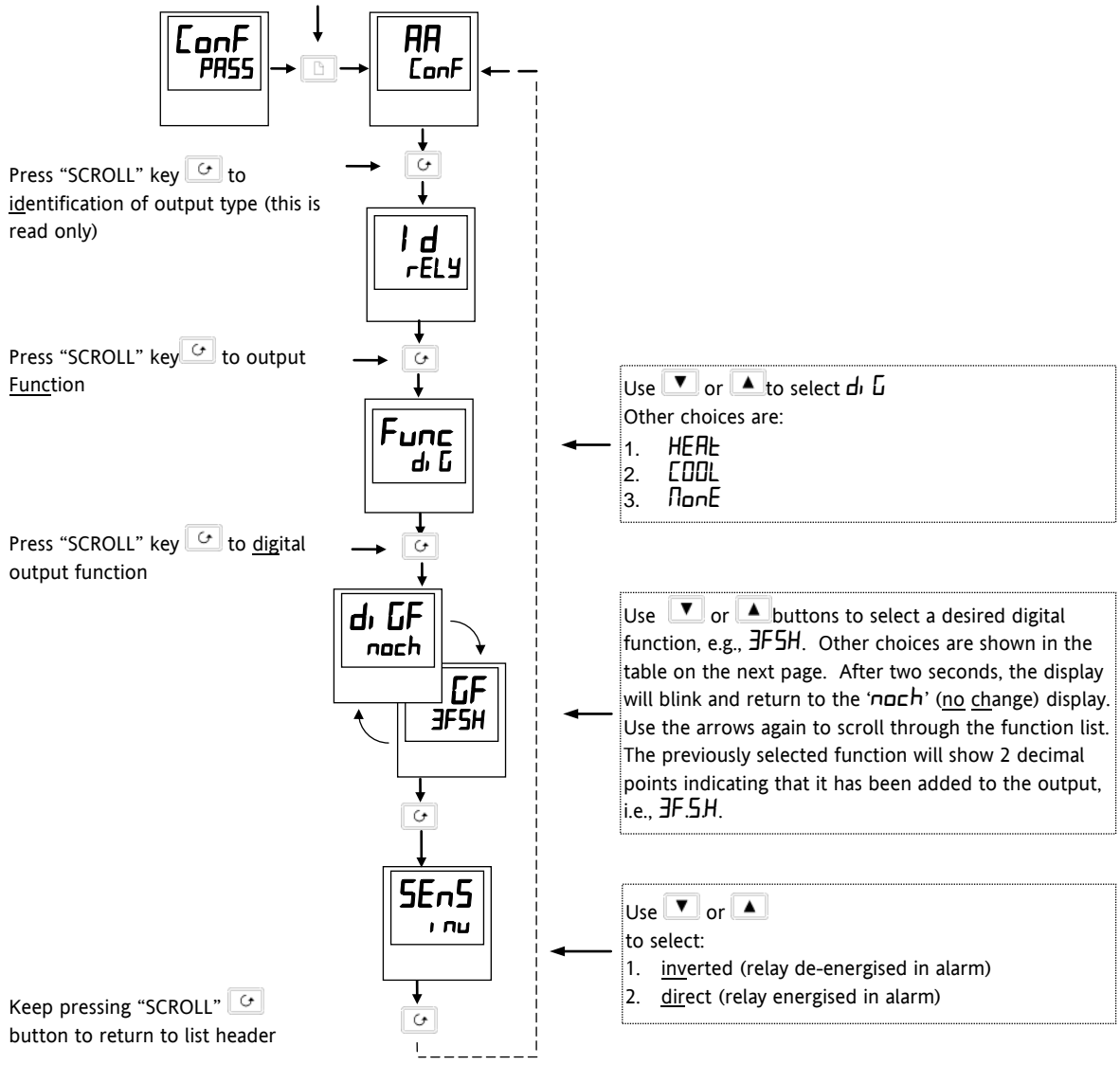


Figure 7-2: Attaching an Alarm to a Physical Output

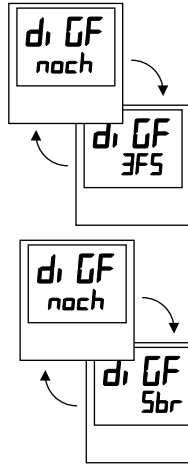
### 7.5 Step 3 - To Group Alarms on a Single Output

In the previous example one alarm condition is allocated to one output relay.

The 2200e series controllers allow alarms and events to be grouped on to a single output. These events are shown in the table below:-

<i>noch</i>	No change
<i>CLr</i>	Clear all existing functions
<i>1 - - -</i>	Alarm 1*
<i>2 - - -</i>	Alarm 2*
<i>3 - - -</i>	Alarm 3*
<i>4 - - -</i>	Alarm 4*

\* See Table B in section 5.6.8.



Press until you reach the 1<sup>st</sup> soft alarm you wish to attach to an output, e.g., *3FSH*.  
The display returns to no change after 2 seconds accepting the condition.

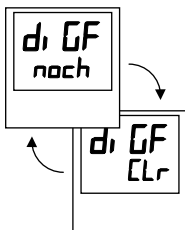
Press until you reach the 2<sup>nd</sup> soft alarm you wish to attach to the output, e.g., *5br*.  
The display returns to no change after 2 seconds accepting the condition.

Repeat for all alarms to be attached to the chosen output

See also section 2.11 for further information on alarm grouping.

Figure 7-3: Grouping Alarms on a Single Output

### 7.6 Step 4 - To Remove Alarms From An Output



Each time you scroll through the table of alarms, note that 2 decimal points appear confirming acceptance that the particular alarm has been attached to the output, i.e., *3F.5H*, *5br*, etc.

Press once to show clear  
After 2 sec. the lower readout reverts to no change clearing all events from the chosen output.

Figure 7-4: Removing Alarms from an Output





## 8 Motorised Valve Control

### 8.1 Parameters For Motorised Valve Control

The 2200e series can be configured for motorised valve control as an alternative to the standard PID control algorithm. This algorithm is designed specifically for positioning motorised valves.

The motorised valve algorithm operates in the boundless mode, which does not require a position feedback potentiometer for control purposes.

The following parameter list will appear in the navigation diagram shown in section 2.8 if your controller is configured for motorised valve control.

Name	Description	Values		
		Min	Max	Default
<b>oP</b>	<b>Output list</b>			
<i>mTr</i>	Valve travel time in seconds. This is the time taken for the valve to travel from its fully closed position to its fully open position.	0.0	999.9	30.0
<i>DP.Lo</i>	<i>DP.Lo</i> is the low output power limit.	- 100.0	100.0	- 100.0
<i>DP.Hi</i>	<i>DP.Hi</i> is the High output power limit	- 100.0	100.0	100.0
<i>On.t.H</i>	Output pulse minimum on time, in seconds.	Auto	999.9	0.2

**Table 8-1: Motorised Valve Parameter List**

### 8.2 Commissioning the Motorised Valve Controller

Proceed as follows:

1. Measure the time taken for the valve to be raised from its fully closed to its fully open position and enter this as the value in seconds into the '*mTr*' parameter.
2. Set all the other parameters to the default values shown in Table 8-1.

The controller can then be tuned using the automatic or manual tuning techniques.





#### 8.2.1 Adjusting the minimum on-time '*On.t.H*'

The default value of 0.2 seconds is satisfactory for most processes. The minimum on time determines how accurately the valve can be positioned. The shorter the time, the more precise the control. However, if the time is set too short, process noise will cause an excessively busy valve.

### 8.3 Motorised Valve Applications

#### 8.3.1 Auto Tuning

Before the auto tune is activated, the *td* parameter must be set to a numeric value. The *td* parameter cannot be set to *OFF* when an auto tune is activated. When the auto tune is complete, the auto tune will set the *td* parameter back to the *OFF* position.

To set *td*, press  to access the PID List in Operator Level. Then press  until *td* is displayed. Press  or  to select any value other than *OFF*.

#### 8.3.2 Valve Positioner Set-up Table

Name	Description	Value
<b>ConF</b>	<b>Configuration Mode</b>	
<i>Ctrl</i>	In the <i>Inst</i> configuration list set the <i>Ctrl</i> to <i>uP</i> .	<i>uP</i>
<i>1A</i>	Module 1A id needs to be a <i>RELY</i> or a <i>SSF</i> . The <i>Func</i> for 1A should be configured for <i>HEAT</i> . (Open Valve)	<i>HEAT</i>
<i>2A</i>	Module 2A id needs to be a <i>RELY</i> or a <i>SSF</i> . The <i>Func</i> for 2A should be configured for <i>COOL</i> . (Close Valve)	<i>COOL</i>
<b>OPER</b>	Operating Mode (OP List)	
<i>mtr</i>	Valve travel time in seconds. This is the time taken for the valve to travel from its fully closed position to its fully open position.	<i>30.0</i>
<i>DPLo</i>	Low output power limit.	<i>- 100.0</i>
<i>DPHi</i>	High output power limit	<i>100.0</i>
<i>Onth</i>	Output pulse minimum on-time, in seconds.	<i>0.2</i>
<b>OPER</b>	Home List	
<i>UPDS</i>	Calculated position of valve	% of motor travel time

**Table 8-2: Valve Positioner Set up Table**



The following operating parameters do not effect the 2200e when the valve positioner option has been configured:

- CYCH* Heat Cycle Time
- CYCL* Cool Cycle Time
- onth* Minimum on time for cooling

## 9 Load Current Monitoring and Diagnostics

### 9.1 Load Current Monitoring and Diagnostics

Current flowing in a system of electrical heating elements (the 'Load') can be displayed on the controller by using a TE10 SSR fitted with intelligent current transformer, PDCTX, or an SSR or contactor with an external PDCTX.

Load current monitoring and diagnostics may be used with any time proportioned output, fitted in module position 1A, and uses the logic output wires which drive the SSR to return signals back to the controller. These signals represent the RMS value of the load current during the ON period, or load related alarm conditions. It is not designed for analogue outputs i.e. phase angle control.

It is also designed for single phase operation only.

There are three modes of operation:-

#### 1. Mode 1

This is used with TE10 SSR only. It detects if there is a **break in the heater circuit**. This includes heater or SSR open circuit. A single **Load Failure** alarm message is displayed on the lower readout of the controller.

#### 2. Mode 2

This is used with TE10 SSR plus PD/CTX intelligent current transformer, and provides:-

<b>Display of true RMS load current</b> On the lower readout of the controller	Displays the true RMS current in the ON state to the load.
<b>Low current alarm</b> Analogous to Partial Load Failure (PLF) supplied in some SSRs	Provides advanced warning of failure of one or more heaters in parallel
<b>High current alarm</b> Activated when the heater exceeds a set limit	Typically used where element bunching may occur
<b>SSR short circuit</b>	This will apply full power to the heaters which could result in an over temperature condition. This alarm provides early warning.
<b>Heater failure</b>	Indicates open circuit load conditions

#### 3. Mode 5 - 2208e & 2204e only

This mode is for use with contactors or other devices which do not use the PDS logic output from the controller as the drive signal. For example, a time proportioning logic, relay or triac output. Mode 5, therefore, requires an additional input to the controller to display the load conditions. It uses the digital input terminals for this, as shown in Figure 9-2. Mode 5 provides the same features as mode 2 with two additional alarms:-

<b>Current Transformer Open Circuit</b>	An alarm is shown if the PDS connection to PDCTX or SSR become disconnected
<b>Current Transformer Short Circuit</b>	An alarm is shown if the PDS connection from PDCTX or SSR are short circuited

## 9.2 Example Wiring Diagram (For mode 1 & 2 operation)

### Hardware Required

1. SSR type **TE10/PDS2** OR
2. Intelligent current transformer type **PD/CTX + contactor or zero voltage switching SSR**

2216e, 2208e or 2204e controller configured for PDS mode 2 option using logic output. This module must be fitted in module position 1. (order code **M2**).

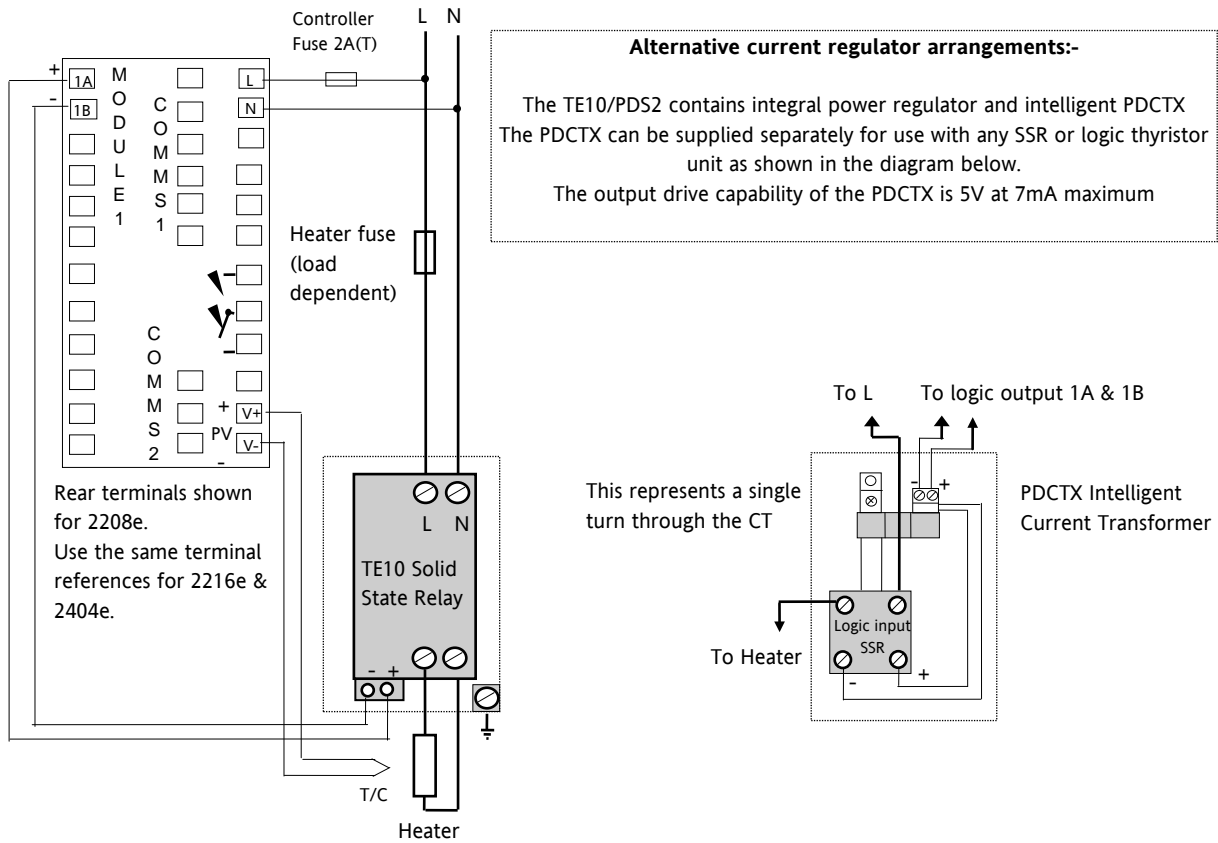


Figure 9-1: Connections for Mode 1 & 2

### Warning

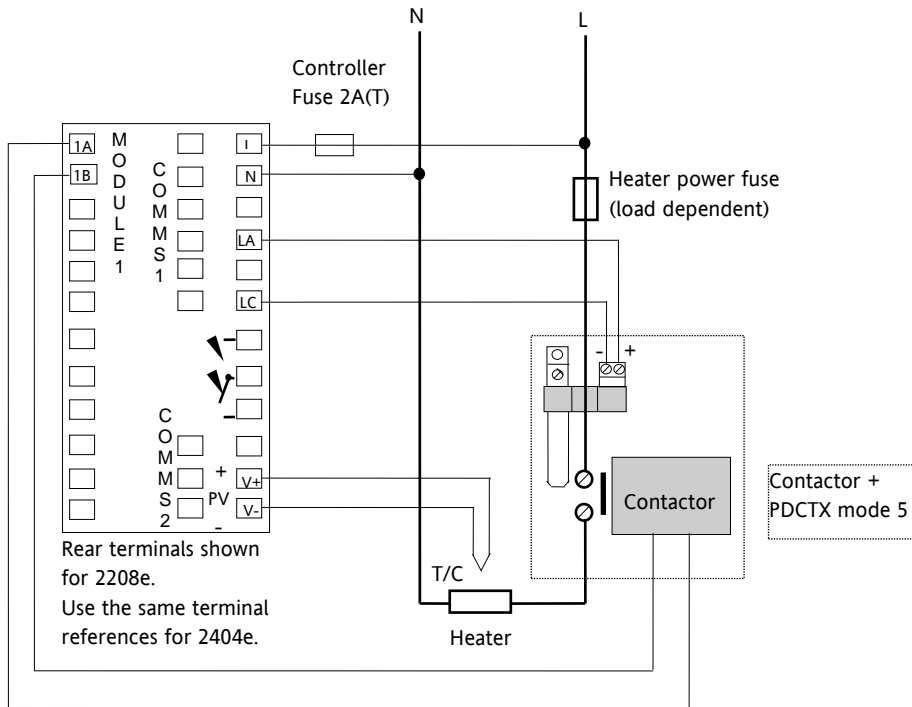


Take care that the controller is correctly wired for the mode of operation which is configured. Failure to do so may be hazardous in some situations.

### 9.3 Example Wiring Diagram (for mode 5 operation)

#### Hardware Required

1. Eurotherm intelligent current transformer type **PD/CTX + contactor**
2. 2208e or 2204e controller configured for PDS mode 5 option using logic, relay or triac output. This module must be fitted in module position 1. Digital input LA (order code **M5**) must be configured to accept PDCTX input as described in the configuration section of this section.



The controller will have the order code M5 in the Logic Input position.

Figure 9-2: Example Wiring Connections for Contactor Operation (mode 5)

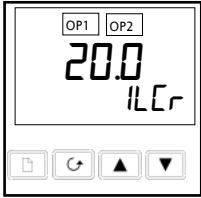
#### Warning!



Take care that the controller is correctly wired for the mode of operation which is configured. Failure to do so may be hazardous in some situations.




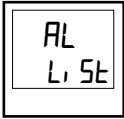



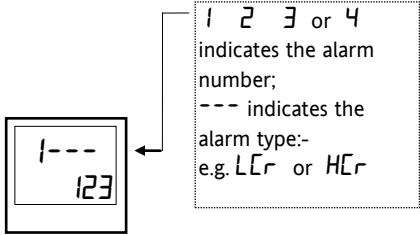
**9.4.4 How Heater Alarms Are Displayed**

Do This	This Is The Display You Should See	Additional Notes
<p>If an alarm is present it will flash a four character mnemonic in the lower display</p>	<p>HOME Display</p> <p>Actual Temperature (PV) →</p> 	<p>If more than one alarm is active, the display will alternate between the alarm messages and the default parameter in the lower display.</p>

**The Alarm Messages are:-**

Mnemonic	Meaning	Description
<p>The following two messages are alarms which are produced as a result of failure within the process. In place of dashes the alarm number will appear i.e 1, 2, 3, or 4</p>		
-LCr	Alarm number - <u>L</u> ow <u>C</u> urrent	Used for partial load failure detection. To avoid nuisance tripping due to supply voltage variations set to a value at least 15% below the minimum normal operating current
-HCr	Alarm number - <u>H</u> igh <u>C</u> urrent	Used for load overcurrent protection. To avoid nuisance tripping due to supply voltage variations set to a value at least 15% above the maximum normal operating current. <b>Note: This alarm is not intended to provide instantaneous safety protection from short circuit fault conditions</b>
<p>The following message is a diagnostic alarm which appears for mode 1 operation only.</p>		
LdF	<u>L</u> oad <u>F</u> ail	This includes failure of the heater circuit or the SSR
<p>The following four messages are diagnostic alarms produced as a result of failure within the equipment or wiring connections. They appear for modes 2 and 5 operation only.</p>		
HtF	<u>H</u> eater <u>F</u> ail	No current is being drawn while the controller output demand signal is on
SSrF	<u>SSR</u> <u>F</u> ail	The load is continuously on while the controller output demand signal is off
CTOP	<u>C</u> urrent <u>T</u> ransformer <u>O</u> pen <u>C</u> ircuit	Indicates that the PDS input is open circuit. Mode 5 only.
CTSh	<u>C</u> urrent <u>T</u> ransformer <u>S</u> hort <u>C</u> ircuit	Indicates that the PDS input is short circuit. Mode 5 only.

**9.5 To Set The Alarm Trip Levels**

Do This	This Is The Display You Should See	Additional Notes
<p>From the HOME display</p> <p>press  until the <b>AL L, St</b> is displayed</p>		<p>To select the Alarm List header</p>
<p>Press  button</p> <p>until the desired alarm number is displayed</p> <p>Press  or  to adjust the alarm trip level</p>		<p>To select the diagnostic alarm parameter found under the Alarm List header</p> <p>The alarm trip level is set to 123</p>

## 9.6 Relay Outputs

The fixed relay output connected to terminals AA to AC in a 1/8 or 1/4 DIN controller is normally used for alarm purposes. In addition, any plug in module can be used for alarms provided they are not already being used for another purpose, such as control. Any one or more alarms can be attached to an output, which will operate when an alarm occurs. Contacts are rated at 2A 264Vac for operating external beacons or audible devices.




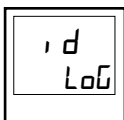



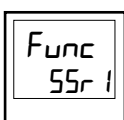



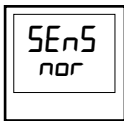
## 9.7 To Configure PDS Load Current Diagnostics

Configuration of PDS load current diagnostics is in four parts:-

1. Configure the Logic Module for PDS Mode 1 or 2 operation. If the control device is a contactor or standard SSR, configure the LA digital input (2208e & 2204e only) for mode 5 operation.
2. Configure the Low and High Current trip alarms.
3. Attach the alarms to operate an output relay.
4. Set up the Scaling Factor.








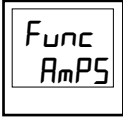
**First enter Configuration Level.** See section 5.1.

### 9.7.1 To Configure the Logic Module for PDS modes 1 or 2

Do This	This Is The Display You Should See	Additional Notes
Press  until the <i>IA Conf</i> is displayed		This opens the configuration list associated with module position 1A
Press  to show <i>id</i>		This shows the identity of the module The module identity is <u>logic</u> output
Press  to show <i>Func</i> Press  or  to show <i>SSr 1</i> or <i>SSr 2</i> as required.		This shows the <u>function</u> of module The module function is set to PDS mode 1
Press  to show <i>SEnS</i> Press  or  to show <i>nor</i>		This sets the output signal to normal for heating control



### 9.7.2 To configure Logic Input 1 for PDS (Mode 5 only)

Do This	This Is The Display You Should See	Additional Notes
Press  button until the <i>LA Conf</i> is displayed		
Press  to show <i>id</i>		This identifies the LA input as logic and is read only
Press  to show <i>Func</i> Press  or  to select <i>AmPS</i>		To configure the input for the PDCTX.










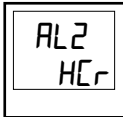


The system is designed to operate in either mode 2 or mode 5 configuration only. Selecting both simultaneously will disable the output. However, mode 1 and mode 5 may be used together.

### 9.8 To Configure Low and High Current Trip Alarms

Alarm 1 will be configured as Load Current Low (*LCr*)




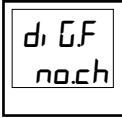


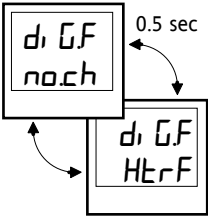
Alarm 2 will be configured as Load Current High (*HCr*)

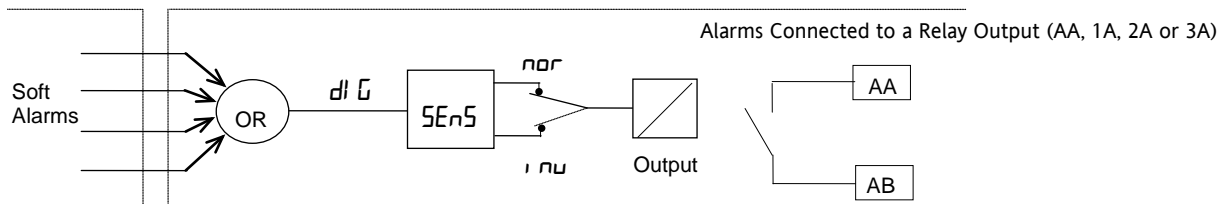
Do This	This Is The Display You Should See	Additional Notes
Press  button until the <i>AL Conf</i> is displayed		This opens the configuration list which contains the Alarms
Press  to show <i>AL 1</i> (alarm 1) Press  or  to show <i>LCr</i>	 After 0.5 sec the display will blink to show the alarm type has been accepted	To select alarm 1  To make alarm 1 = <u>L</u> ow <u>C</u> urrent
Press  until <i>AL 2</i> (alarm 2) appears Press  or  to show <i>HCr</i>	 After 0.5 sec the display will blink to show the alarm type has been accepted	To select alarm 2.  To make alarm 2 = <u>H</u> igh <u>C</u> urrent



**Note:-** The above alarms are known as SOFT ALARMS because they are indication only. The next section shows how to configure an alarm to trigger a relay.

### 9.9 To Attach Soft Alarms to a Relay Output

Any one alarm indicated above may be attached to an output (normally a relay). Alternatively any combination of alarms may be attached to operate a relay using the procedure below:-

Do This	This Is The Display You Should See	Additional Notes
Press "PAGE" key  as many times as necessary to <i>AA Conf</i>		Any output module can be configured for an alarm output provided it is not used for any other purpose, eg as a control output.  In place of <i>AA</i> you should select the module required, i.e. <i>1A, 2A, 3A</i>
Press  until <i>d GF</i> appears		<i>d GF</i> = <u>d</u> igital <u>G</u> unctions <i>noch</i> = <u>n</u> o <u>c</u> hange
Press  or  until the first alarm you wish to attach to the AA output is displayed e.g. <i>Ht r F</i>  Repeat the above step for every alarm to be attached to the output		After 0.5 second the display will revert to <i>noch</i> to attach the alarm  Each time you scroll through the table of alarms note that two decimal points appear. This confirms that the particular alarm has been attached to the output, i.e. <i>Ht r F 55 r F</i> etc



To remove alarms from an output press  or  until *CLR* appears in the lower display. This will clear all alarms attached to this output.







### 9.10 The Scaling Factor

The value of the current displayed on the controller is scaled using the scaling factor. This is found in the *nSt Conf* list. It is set, by default, to 100 and assumes a single turn through the current transformer. If two turns are made through the current transformer it will be necessary to adjust the scaling factor to 50 to obtain the same reading.

Under normal conditions you should not need to change the scaling factor.

If, however, you wish to change the sensitivity of the current reading, for example, to read very low currents you may need to change the number of turns through the PDCTX and/or adjust the scaling factor to compensate. See also note 1 below.

#### 9.10.1 To Adjust The Scaling Factor

Do This	This Is The Display You Should See	Additional Notes
Press  button until <i>nSt Conf</i> is displayed		
Press  until <i>LCH1</i> is displayed  Press  or  to change the scaling factor		

**Note 1:-**

**Minimum Resolvable Current**

TE10 4A RMS. It is not possible to read currents lower than 4A when using a TE10.

PDCTX 4A RMS for a single turn through the PDCTX

Should you wish to read currents lower than 4A using a PDCTX it is necessary to increase the number of turns through the PDCTX and adjust the scaling factor to compensate.

For example: To read 1.0A wind 4 turns through the PDCTX and adjust the scaling factor to 25 as shown in the table below.

Scalar = 100/N Where N = Turns through PDCTX	
N	Scalar
1	100
2	50
4	25
5	20
10	10

**Maximum Resolvable Current**

TE10 Determined by the maximum range of the SSR

PDCTX 100A (or 100 ampere turns)

**Finally Exit configuration level.** See section 5.3.



## 10 Retransmission

### 10.1 What is retransmission

The controller can be configured to generate an analogue output signal which represents a selected parameter.

The parameters which can be configured for retransmission are:-

1. Process Variable
2. Setpoint
3. Error
4. Control Output








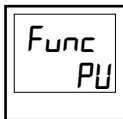

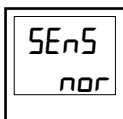

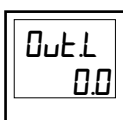


The retransmission signal is available as 0-20mA, 4-20mA, 0-5V, 1-5V or 0-10V and is connected to terminals 1A and 1B when module 1A is fitted as a DC module.

### 10.2 To Configure Retransmission

A DC module must be fitted in module position 1A.

**First enter configuration level.** See section 5.1.

Then:-

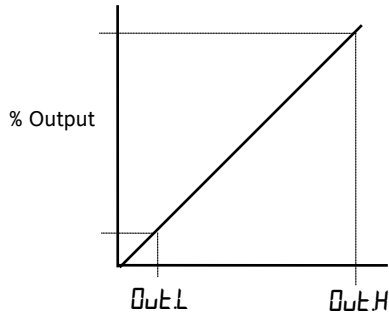
Do This	This Is The Display You Should See	Additional Notes
Press  button until the <i>1A Conf</i> is displayed		This opens the configuration list for module 1A.
Press  to show <i>1A</i>		This is the identity of the module fitted in this position  The module must be a DC output <i>dC.OP</i>
Press  to show <i>Func</i>  Press  or  to select the parameter for retransmission		The choices are:- <i>nonE</i> Output turned off <b>Control Outputs</b> <i>HEAT</i> Heat control output <i>COOL</i> Cool control output <b>Retransmission</b> <i>OP</i> Output demand <i>PU</i> Process Variable <i>Err</i> Error <i>wSP</i> Setpoint (working)
Press  to show <i>SEnS</i>		If <i>Func</i> is a retransmission parameter the value of <i>SEnS</i> has no effect.
Press  to show <i>OutL</i>		The retransmitted output signal can be limited by adjusting these parameters.
Press  to show <i>OutH</i>		To reverse the output, set <i>OutL</i> to <i>20.0</i> and <i>OutH</i> to <i>0.0</i> .

### 10.3 To Scale Retransmitted Output Signals

The analogue output signal may be set between 0 and 20mA. A 4-20mA output is achieved by applying an offset as described below.

A 0 to 10Vdc output may be achieved by fitting a 500 ohm resistor across the output terminals 1A and 1B. A 0 to 5Vdc output may be achieved by fitting a 250 ohm resistor across the output terminals 1A and 1B. Suitable resistors are supplied with the controller.

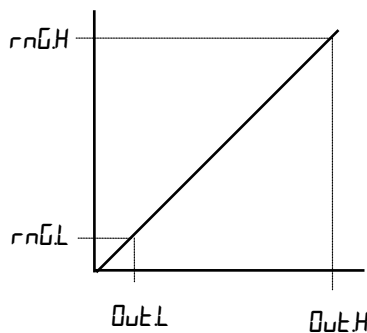
#### 10.3.1 To Range Retransmitted Output $OP$



For output of 0-100% = 0-20mA  
set  $OUTH$  to 20.0 and  $OUTL$  to 0.0

For output of 0-100% = 4-20mA  
set  $OUTH$  to 20.0 and  $OUTL$  to 4.0

#### 10.3.2 To Range Retransmitted Setpoint $SP$ or Process Variable $PU$



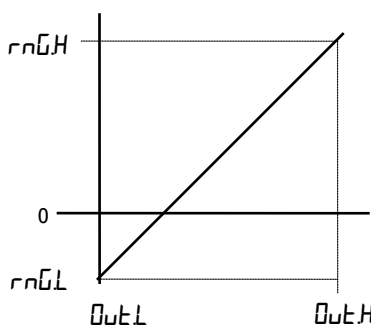
**For output of 0 - 1000°C = 0 - 20mA**  
set  $INL$  to 0.0 and  $INH$  to 20.0  
and  $OUTL$  to 0.0 and  $OUTH$  to 1000

$INL$  is the low limit of the input range

$INH$  is the high limit of the input range

These are found in the  $IPCONF$  list as described in section 5. If the range limits are not set the retransmitted output is the maximum input range as stated in the order code, section 11.

#### 10.3.3 To Range Retransmitted Error $ERR$



The retransmitted output value is dependent upon the range limits  $ERRH$  and  $ERRL$  set in the  $IPCONF$  list of the controller.

The following examples are given to illustrate the retransmitted error values:

**Example 1:**

Type K thermocouple,

$ERRL$  = -200

$ERRH$  = +200

Retransmitted Value

0mA for an error of -200

10mA for an error of 0

20mA for an error of +200

**Example 2:**

As above but  $ERRL$  = -10 and  $ERRH$  = 400

Retransmitted Value

0mA for an error of -10

0.0487mA for an error of 0

20mA for an error of +400

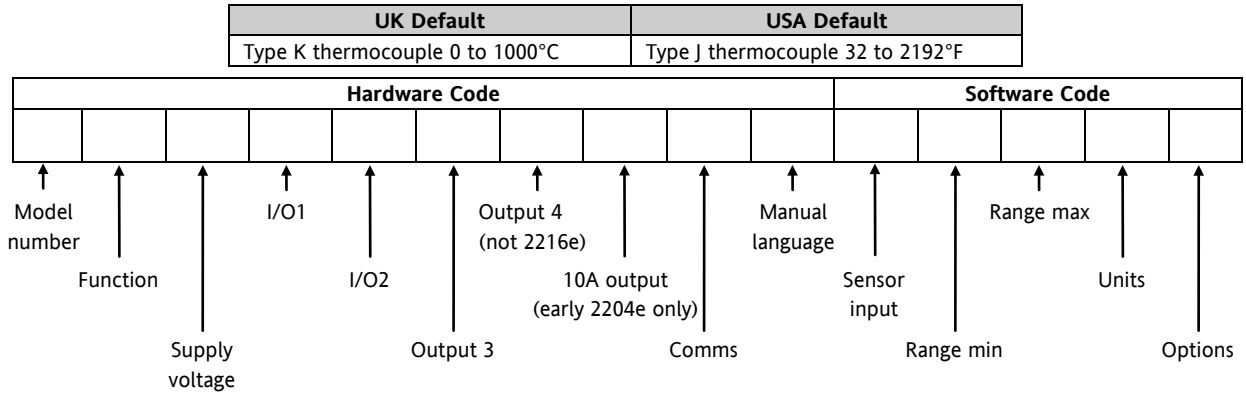
**Note:**

To read a negative error it is necessary to set  $ERRL$  to a negative limit

# 11 Understanding the Order Code

2200e series controllers have a modular hardware construction with the option of up to four outputs and one communications port. Two logic inputs are provided as standard in 2208e & 2204e.

The ordering code is in two parts: the hardware code followed by the software code. The hardware code specifies the hardware build of the controller, and the software code the software configuration. The software code is optional.



### Hardware code

Model number	Function	Supply voltage	I/O 1	I/O 2	Output 3	Output 4 (not 2216e)	10A output *	Comms	Manual	Default Settings
		VH								

Model number
2216e 48x48mm unit
2208e 48x96mm unit
2204e 96x96mm unit

Function
CC Controller
VC Valve Positioner
NF On/Off
AL Alarm unit

Supply voltage
VH 100-230Vac

I/O 1
XX None
Relay: 2-pin
R1 Unconfigured
RU VP raise O/P
RH PID heating
FH High alarm 1
FL Low alarm 1
DB Deviation band 1
DL Low dev. alarm 1
DH High dev alarm 1
Logic: non-isolated
L1 Unconfigured
LH PID heating
M1 PDS mode 1 note 1
M2 PDS mode 2 note 2
Triac
T1 Unconfigured
TH PID heating
TU VP raise O/P
DC control -isolated
D3 Unconfigured
H6 0-20mA PID heating
H7 4-20mA PID heating
C6 0-20mA PID cooling
C7 4-20mA PID cooling
DC Retrans. (isolated)
Select from table A

I/O 2
XX None
Relay: 2-pin
R1 Unconfigured
RC Cooling output
RH Heating output
RW VP lower O/P
FH High alarm 2
FL Low alarm 2
DB Deviation band 2
DL Low deviation alarm 2
DH High deviation alarm 2
AL Hi & Lo alarms 1 & 2
Logic Input
AM Auto manual select
S2 Setpoint 2 select
AC Alarm ack/reset
EH Integral hold
SB Standby mode
SR PDS remote SP select
M5 CTX mode 5 current input
Logic output
L1 Unconfigured
LC PID cooling
LH Heating output
Triac
T1 Unconfigured
TC PID cooling
TW VP lower O/P
TH Heating output

Outputs 3 and 4
XX None
RF Unconfigured
RH PID heating
RC PID cooling
FH High alarm 3
FL Low alarm 3
DB Deviation band 3
DL Low deviation alarm 3
DH High deviation alarm 3
AL High and Low alarms
PDS Alarms
LF Heater break
HF Current monitoring heater break
SF Current monitoring SSR failure

10A output 2204e only
* Note:- This option is not available on controllers after Jan-04.
XX None
R5 fitted unconfig.
RH PID heating

Comms
2XX None
Modbus protocol
2YM 2-wire RS485
2FM 4-wire RS422
2AM RS232
El-Bisynch
2YE 2-wire RS485
2FE 4-wire RS422
2AE RS232
DeviceNet
2DN DeviceNet
PDS Input
2RS Setpoint

Manual
XXX No manual
ENG English
FRA French
GER German
ITA Italian

Default settings
AO American
EO European

Table A
D6 Fitted unconfigured
V- PV retrans
S- Setpoint retrans
O- Output retrans
Z- Error retrans
-1 0-20mA
-2 4-20mA
-3 0-5V
-4 1-5V
-5 0-10V

**Software code**

Sensor input	Range min (note 2)	Range max (note 2)	Units	Digital input 1	Digital input 2	Options
				Digital inputs are not available in 2216e		

Sensor input	Range Min	Range Min			
Standard sensors		Min °C	Max	Min °F	Max
J	J thermocouple	-210	1200	-340	2192
K	K thermocouple	-200	1372	-325	2500
T	T thermocouple	-200	400	-325	750
L	L thermocouple	-200	900	-325	1650
N	N thermocouple	-200	1300	-325	2370
R	R thermocouple	-50	1768	-58	3200
S	S thermocouple	-50	1768	-58	3200
B	B thermocouple	0	1820	32	3310
P	Platinel II therm'ple	0	1369	32	2496
Z	RTD/PT100	-200	850	-325	1562
Custom sensors (*replaces C thermocouple)					
C	*C thermocouple	0	2319	32	4200
	W5%Re/W26%Re (Hoskins)				
D	W3%Re/W25%Re	0	2399	32	4350
E	E thermocouple	-200	1000	-325	1830
1	Ni/Ni18%Mo	0	1399	32	2550
2	Pt20%Rh/Pt40%Rh	0	1870	32	3398
3	W/W26%Re (Englehard)	0	2000	32	3632
4	W/W26%Re (Hoskins)	0	2010	32	3650
5	W5%Re/W26%Re (Englehard)	10	2300	50	4172
6	W5%Re/W26%Re (Bucose)	0	2000	32	3632
7	Pt10%Rh/Pt40%Rh	-200	1800	392	3272
8	Exergen K80 IR pyrometer	-45	650		
Process inputs		Min		Max	
M	-9.99 to +80.00mV	-999		9999	
Y	0 to 20mA	-999		9999	
A	4 to 20ma	-999		9999	
W	0 to 5Vdc	-999		9999	
G	1 to 5Vdc	-999		9999	
V	0 to 10Vdc	-999		9999	

Units	
C	Centigrade
F	Fahrenheit
K	Kelvin
X	Linear input

Digital inputs 1 & 2 (2208e & 2204e only)	
XX	No function
AM	Manual select
SR	Remote setpoint select
S2	Second setpoint
EH	Integral hold
AC	Alarm acknowledge
SB	Standby mode
M5	CTX mode 5 current input (input 1 only)

Options	
Control action	
XX	Reverse acting (standard)
DP	Direct acting PID
Power feedback	
XX	Enabled on logic, relay & triac heating outputs
PD	Power feedback disabled
Cooling options	
XX	Linear cooling
CF	Fan cooling
CW	Water cooling

**Notes:**

1. PDS heater break detect will transmit the power demand to a TE10 solid state relay and read back a heater break alarm.
2. PDS current monitoring will transmit the power demand to a TE10 solid state relay and read back load current and open and short circuit alarms.
3. Setpoint limits: Include the decimal position required in the displayed value – up to one for temperature inputs, up to two for process inputs
4. An external 1% current sense resistor is supplied as standard. If greater accuracy is required, a 0.1% 2.49Ω can be ordered as part number SUB2K/249R.1.

Example ordering code:

2208e-CC-VH-LH-TC-FL-FH-2YM-ENG-K-0-1000-C-XX-XX-XX-XX-XX


*2208e controller, 100 to 240Vac, logic heating, triac cooling, low alarm relay, high alarm relay, EIA485 Modbus comms, English manual, type K thermocouple, 0 to 1000°C, digital input 1 no function, digital input 2 no function, reverse acting, power feedback enabled, linear cooling.*



## 12 SAFETY and EMC Information

This instrument is intended for industrial temperature and process control applications within the requirements of the European Directives on Safety and EMC.

The information contained in this manual is subject to change without notice. While every effort has been made to ensure the accuracy of the information, your supplier shall not be held liable for errors contained herein.

 The safety and EMC protection can be seriously impaired if the unit is not used in the manner specified. The installer must ensure the safety and EMC of the installation.

**Safety.** This instrument complies with the European Low Voltage Directive 2006/95/EC, by the application of the safety standard EN 61010.

**Unpacking and storage.** If on receipt, the packaging or unit is damaged, do not install but contact your supplier. If being stored before use, protect from humidity and dust in an ambient temperature range of -10°C to +70°C.

**Electrostatic discharge precautions.** Always observe all electrostatic precautions before handling the unit.



**Service and repair.** This instrument has no user serviceable parts. Contact your supplier for repair.

**Cleaning.** Isopropyl alcohol may be used to clean labels. Do not use water or water based products. A mild soap solution may be used to clean other exterior surfaces.

**Electromagnetic compatibility.** This instrument conforms with the essential protection requirements of the EMC Directive 2004/108/EC, by the application of a Technical Construction File. It satisfies the general requirements of the industrial environment defined in EN 61326.

**Caution: Charged capacitors.** Before removing an instrument from its sleeve, disconnect the supply and wait at least two minutes to allow capacitors to discharge. Avoid touching the exposed electronics of an instrument when withdrawing it from the sleeve.

**Safety Symbols.** Symbols used on the instrument have the following meaning:

 Caution, refer to accompanying documents).  Equipment protected throughout by DOUBLE INSULATION

**Installation Category and Pollution Degree.** This unit has been designed to conform to BSEN61010 installation category II and pollution degree 2, defined as follows:-

- Installation Category II (CAT II). The rated impulse voltage for equipment on nominal 230V supply is 2500V.
- Pollution Degree 2. Normally only non conductive pollution occurs. However, a temporary conductivity caused by condensation must be expected.

**Personnel.** Installation must only be carried out by suitably qualified personnel.

**Enclosure of Live Parts.** To prevent hands or metal tools touching parts that may be electrically live, the controller must be installed in an enclosure.

**Caution: Live sensors.** The controller is designed to operate if the temperature sensor is connected directly to an electrical heating element. However, you must ensure that service personnel do not touch connections to these inputs while they are live. With a live sensor, all cables, connectors and switches for connecting the sensor must be mains rated for use in 230Vac +15%: CATII.

**Wiring.** It is important to connect the unit in accordance with the data in this sheet ensuring that the protective earth connection is ALWAYS fitted first and disconnected last. Wiring must comply with all local wiring regulations, i.e. UK, the latest IEE wiring regulations, (BS7671), and USA, NEC Class 1 wiring methods.



Do not connect AC supply to low voltage sensor input or low level inputs and outputs.

Voltage rating. The maximum continuous voltage applied between any of the following terminals must not exceed 230Vac +15%:

- relay output to logic, dc or sensor connections;
- any connection to ground.

The controller must not be wired to a three phase supply with an unearthed star connection. Under fault conditions such a supply could rise above 240Vac with respect to ground and the product would not be safe.

**Conductive pollution.** Electrically conductive pollution i.e. carbon dust, MUST be excluded from the enclosure in which the controller is installed. To secure a suitable atmosphere in conditions of conductive pollution, fit an air filter to the air intake of the enclosure. Where condensation is likely, include a thermostatically controlled heater in the enclosure.

**Grounding of the temperature sensor shield.** In some installations it is common practice to replace the temperature sensor while the controller is still powered up. Under these conditions, as additional protection against electric shock, we recommend that the shield of the temperature sensor is grounded. Do not rely on grounding through the framework of the machine.

#### Over-temperature protection

When designing any control system it is essential to consider what will happen if any part of the system should fail. In temperature control applications the primary danger is that the heating will remain constantly on. Apart from spoiling the product, this could damage any process machinery being controlled, or even cause a fire.

Reasons why the heating might remain constantly on include:

- the temperature sensor becoming detached from the process
- thermocouple wiring becoming short circuit;
- the controller failing with its heating output constantly on
- an external valve or contactor sticking in the heating condition
- the controller setpoint set too high.

Where damage or injury is possible, we recommend fitting a separate over-temperature protection unit, with an independent temperature sensor, which will isolate the heating circuit.

Please note that the alarm relays within the controller will not give protection under all failure conditions.

**Installation Requirements for EMC.** To comply with European EMC directive certain installation precautions are necessary:-

- General guidance. Refer to EMC Installation Guide, Part no. HA025464.
- Relay outputs. It may be necessary to fit a suitable filter to suppress conducted emissions.
- Table top installation. If using a standard power socket, compliance with commercial and light industrial emissions standard is usually required. To comply with conducted emissions standard, a suitable mains filter must be installed.

#### Routing of wires

To minimise the pick-up of electrical noise, the low voltage DC connections and the sensor input wiring should be routed away from high-current power cables.

Where this is impractical, shielded cables should be used for the signal wiring. Where signal wiring is carrying (or could carry, under fault conditions) hazardous voltages\*, double insulation should be used.

\* A full definition of 'hazardous' voltages appears under 'Hazardous Live' in BS EN61010. Briefly, under normal operating conditions Hazardous voltage levels are defined as >30V RMS (42.2V peak) or >60V dc.

## 12.1 Technical Specification

### Inputs

General	Range	$\pm 100\text{mV}$ and 0 to 10Vdc (auto ranging)
	Sample rate	9Hz (110mS)
	Calibration accuracy	0.25% of reading, $\pm 1$ LSD or $\pm 1^\circ\text{C}/\text{F}$
	Resolution	$< 1\mu\text{V}$ for $\pm 100\text{mV}$ range, $< 0.2\text{mV}$ for 10Vdc range
	Linearisation accuracy	$< 0.1\%$ of reading
	Input filter	1.0 to 999.9secs
	Zero offset	User adjustable over the fully display range
Thermocouple	Types	Refer to Sensor inputs and display ranges table
	Cold junction compensation	Automatic compensation typically $> 30$ to 1 rejection of ambient temperature change (incorporates INSTANT ACCURACY™ cold junction sensing technology).  External references 32, 113 and 122°F (0, 45 and 50°C)
RTD/PT100	Type	3-wire, Pt100 DIN43760
	Bulb current	0.2mA
	Lead compensation	No error for 22 ohms in all 3 leads
Process	Linear	-9.99 to 80.00mV, 0 to 20mA or 0 to 10Vdc (All configurable between limits)
Digital	Type	Contact closure
	Application	Manual select, 2nd setpoint, keylock, setpoint rate limit enable

### Outputs

Relay	Rating: 2-pin relay	Min: 12V, 100mA dc Max: 2A, 264Vac resistive
	Rating: change-over, alarm relay	Min: 6V, 1mA dc Max: 2A, 264Vac resistive
	Application	Heating, cooling or alarms
Logic	Rating	18Vdc at 24mA (non-isolated)
	Application	Heating, cooling or alarms  PDS mode 1: SSRx Load Doctor™ logic heating with load failure alarm  PDS mode 2: SSRx Enhanced Load Doctor™ logic heating with load/SSC failure alarm and load current display
	Application	Heating or cooling
High current	Rating	10A, 264Vac resistive. Note:- This option is not available on controllers after Jan-04.
	Application	Heating
Analog	Range	Isolated 0 to 20mA or 0 to 10Vdc (configurable between limits)
	Application	Heating or cooling

### Communications

Digital	Transmission standard	EIA-485 2wire, EIA-422 4 wire or EIA-232 at 1200, 2400, 4800, 9600, 19,200 baud. 1200 baud is not available with EI-Bisynch.  125K, 250K, 500K for DeviceNet
	Protocols	Modbus®, EI-Bisynch, DeviceNet
PDS	Setpoint input	Setpoint input from master PDS controller

**Control functions**

Control	Modes	PID or PI with overshoot inhibition, PD, P only or On/Off
	Application	Heating and cooling
	Auto/manual	Bumpless transfer
	Setpoint rate limit	0.01 to 99.99 degrees or display units per minute.
	Cooling algorithms	Linear; Water (non-linear); Fan (minimum on time), Oil, proportional only
Tuning	One-shot tune	Automatic calculation of PID and overshoot inhibition parameters
	Automatic droop compensation	Automatic calculation of manual reset value when using PD control
Alarms	Types	Full scale high or low. Deviation high, low, or band
	Modes	Latching or non-latching. Normal or blocking action
		Up to four process alarms can be combined onto a single output

**General**

Display	Dual, 4 digit x 7 segment high intensity LED
Dimensions and weight	2216e:- 48W x 48H x 103Dmm (1.89W x 1.89H x 4.04D inches) 250g (8.8oz)
	2208e:- 48W x 96H x 103Dmm (1.89W x 3.78H x 4.06D inches) 320g (11oz)
	2204e:- 96W x 96H x 103Dmm (3.78W x 3.78H x 4.06D inches) 600g (21oz)
Supply	100 to 230Vac +/-15%, 48 to 62Hz. 10watts max
Temperature and RH	Operating: 32 to 131°F (0 to 55°C), RH: 5 to 90% non-condensing. Storage: 14 to 158°F (-10 to 70°C)
Panel sealing	IP 65
Electromagnetic compatibility	EN61326-1 generic standards for industrial environments
Safety standards	EN61010, installation category 2 (voltage transients must not exceed 2.5kV)
Atmospheres	Electrically conductive pollution must be excluded from the cabinet in which this controller is mounted. This product is not suitable for use above 6,562ft (2000m) or in corrosive or explosive atmospheres without further protection.





## 13 Supplement 2208e Instruments

### New Short Sleeve Design MkIII

This supplement applies to:-

2208e Controllers	Manufactured from Feb-03	The month and year of manufacture are shown in the last two pairs of digits of the instrument serial number.
----------------------	--------------------------	--

From Feb-03 an improved design of 1/8 DIN short sleeve is shipped with all new 2208e controllers (and 2108i indicators).

#### Details

A new sealing gasket will be fitted onto the instrument bezel ①. This gasket replaces the gasket which was moulded into the front of the sleeve of all previous instruments.

The gasket previously moulded into the sleeve where it fits behind the panel is now supplied as a separate item ②.

#### Reasons for the Change

This change is to ensure that IP65 sealing is reliably achieved and less physical effort is required to insert the instrument into the new sleeve.

#### Recommendations

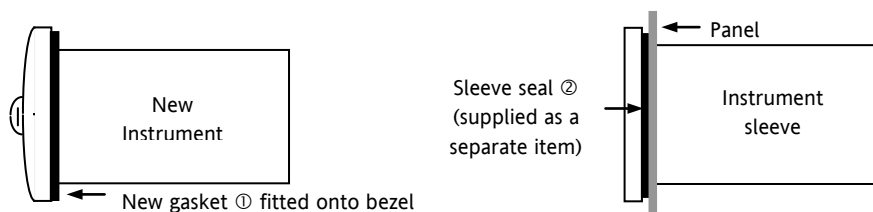
1. An instrument delivered after Jan 03 should be used with the sleeve supplied
2. If the instrument is required to replace one already in use, the existing sleeve should also be replaced
3. A new instrument can be fitted into an existing sleeve by carefully removing gasket ① but IP65 sealing will not be maintained
4. An existing instrument can be fitted into a new sleeve but IP65 sealing will not be maintained

It is, however, possible to achieve IP65 sealing for 3 and 4 above. A gasket kit is available from Eurotherm by quoting Part No SUB24/GAS2408.

Then:-

5. To fit a new instrument in an older sleeve carefully remove gasket ①. Replace it with the thinner (1.25mm) gasket from the kit
6. To fit an existing instrument into a new sleeve fit the thicker (1.6mm) gasket from the kit between the instrument and the sleeve

The seal ② supplied as a separate item with a new instrument, should be placed over the sleeve prior to mounting it through the panel cut out as shown below:-







## 14 Index

### A

Acknowledge, 2-18, 5-7, 5-10, 7-2  
 Address, 5-11  
 AL1, 5-7, 9-7  
 Alarm, 2-11, 2-15, 2-16, 2-17, 5-7, 5-8, 5-9, 7-1, 7-2, 7-4, 9-5, 9-7  
 Alarm Relay, 2-16, 5-8  
 Automatic, 2-6, 2-12, 4-1, 4-4, 5-6, 12-4, 12-5

### B

Block Diagram, 2-9  
 Blocking Alarms, 2-15

### C

Calibration, 2-13, 5-6, 6-1, 6-2, 6-3, 12-4  
 CLr, 9-8  
 Configuration, 1-4, 2-8, 2-14, 3-1, 3-2, 5-1, 5-2, 5-5, 5-6, 5-7, 5-8, 5-9, 5-10, 5-11, 6-1, 6-3, 7-1, 7-3, 8-2, 9-6  
 Current Transformer, 9-1, 9-5  
 Cutback, 2-12

### D

DC, 1-6, 1-8, 1-10, 4-1, 5-9, 10-1, 12-3  
 Derivative Time, 4-3  
 Dimensions, 1-2, 12-5  
 Display Mnemonic  
   Ac.AL, 5-7, 5-10  
   AL1, 5-7, 9-7  
   AL2, 5-7, 9-7  
   AL3, 5-7  
   AL4, 5-7  
 Auto, 2-6, 2-11, 2-12, 2-13, 4-2, 4-3, 5-6, 5-7, 5-9, 7-2, 8-1, 8-2, 12-5  
 b.tc, 5-6  
 C.tc, 5-6  
 CAL, 2-13, 5-5, 5-6, 6-1, 6-2, 6-3  
 CAL.S, 2-13  
 CJC, 5-6  
 Conf, 2-11, 5-5, 9-6, 9-7, 9-9, 10-1  
 Dwell, 2-7, 2-8, 2-12  
 EVENT, 2-11  
 Heat, 2-13, 7-1, 8-2, 10-1  
 J.tc, 5-6  
 L.tc, 5-6  
 Lbr, 5-9  
 Loc.b, 5-7, 5-10  
 mAn, 4-4, 5-7, 5-10, 7-2  
 n.tc, 5-6  
 none, 1-10, 2-11, 5-5, 5-7, 5-8, 5-11  
 r.tc, 5-6  
 S.tc, 5-6

Sbr, 5-5, 5-9  
 SP1, 2-12  
 SP2, 2-2, 2-8, 2-12  
 t.tc, 5-6  
 TC, 11-2  
 TD, 8-2

### E

Event, 2-11

### H

Heat, 2-13, 7-1, 8-2, 10-1  
 High Cutback, 4-1, 4-3  
 HOME, 2-3, 2-5, 2-11, 2-17, 9-4, 9-5  
 Hysteresis, 2-11, 2-15

### I

ID, 2-11  
 Input, 1-6, 2-13, 2-18, 5-5, 5-6, 6-2, 9-3, 9-7, 12-4  
 Input filter, 2-13, 12-4  
 Input Type  
   Type mV, 2-13, 5-6  
 Input/Output, 5-5  
 Installation, 1-1, 1-3, 12-1, 12-2, 12-3  
 Integral, 2-12, 4-1, 4-3, 5-7, 5-10  
 Integral Time, 4-3  
 Internet Site  
   UK, 5-12

### L

Latching Alarm, 2-15  
 Linear, 5-5, 5-6, 12-4, 12-5  
 Logic, 1-6, 1-8, 5-7, 5-9, 5-10, 9-3, 9-6, 9-7, 12-4  
 Low Cutback, 4-3

### M

mAn, 4-4, 5-7, 5-10, 7-2  
 Manual, 2-2, 2-6, 2-12, 4-3, 4-4, 5-7, 5-9, 5-10, 7-2, 11-1, 12-4  
 Modbus, 11-2, 12-4

### N

Name, 2-2, 2-11, 2-12, 2-13, 2-14, 5-5, 5-6, 6-3, 8-1, 8-2

### O

One-shot, 4-1, 12-5  
 Output Power, i, 2-6

**P**

PID, 1-6, 2-12, 4-4, 5-5, 8-1, 8-2, 12-5  
PV, 2-8, 2-13, 2-15, 5-9, 7-2, 10-1, 10-2, 12-2

**R**

ramp, 2-7, 2-8  
Relay, 1-6, 5-8, 5-9, 5-10, 7-2, 9-6, 9-8, 12-4  
Reset, 2-12, 4-4, 5-7, 5-10  
RTD, 12-4  
Run, 2-2, 2-8

**S**

SETPOINT 1, 2-7  
SETPOINT 2, 2-7  
Sleeve, 13-1

**T**

Terminals, 1-4, 1-5, 5-5  
Thermocouple, 12-4  
    Type b – b.tc, 5-6  
    Type C – C.tc, 5-6  
    Type J – J.tc, 5-6  
    Type L – L.tc, 5-6  
    Type n – n.tc, 5-6  
    Type r – r.tc, 5-6  
    Type S – S.tc, 5-6  
    Type t – t.tc, 5-6  
Tuning, 4-1, 4-3, 8-2, 12-5

**U**

User calibration, 2-13, 5-6, 6-1, 6-2, 6-3

**W**

Wiring, 1-4, 1-7, 1-9, 1-10, 5-5, 9-2, 9-3, 12-2



**Eurotherm Limited**

Faraday Close,  
Durrington,  
Worthing, West Sussex,  
BN13 3PL  
Telephone: +44 (01903) 268500  
Fax: +44 (01903) 265982

**Worldwide Offices**

[www.eurotherm.com/worldwide](http://www.eurotherm.com/worldwide)



Scan for local contacts

**© Copyright Eurotherm Limited 2015**

Eurotherm by Schneider Electric, the Eurotherm logo, Chessell, EurothermSuite, Mini8, Eycan, Eyris, EPower, EPack, nanodac, piccolo, versadac, optivis, Foxboro and Wonderware are trademarks of Schneider Electric, its subsidiaries and affiliates. All other brands may be trademarks of their respective owners.

All rights are strictly reserved. No part of this document may be reproduced, modified, or transmitted in any form by any means, nor may it be stored in a retrieval system other than for the purpose to act as an aid in operating the equipment to which the document relates, without the prior written permission of Eurotherm Limited.

Eurotherm Limited pursues a policy of continuous development and product improvement. The specifications in this document may therefore be changed without notice. The information in this document is given in good faith, but is intended for

guidance only. Eurotherm Limited will accept no responsibility for any losses arising from errors in this document.