

SAFETY NOTES

DANGER

HAZARD OF ELECTRICAL SHOCK, EXPLOSION OR ARC FLASH

Apply appropriate personal protective equipment (PPE) and follow safe electrical work practices. See applicable national standards e.g. NFPA70E, CSA Z462, BS 7671, NFC 18-510.

This equipment must only be installed and serviced by qualified electrical personnel. Refer to manual for installation and servicing.

The product is not suitable for isolation applications, within the meaning of EN60947-1. Turn off all power supplying this equipment before working on the loads of the equipment.

Turn off all power supplying this equipment before working on equipment.

Always use a properly rated voltage sensing device to confirm power is off.

If on receipt, the unit or any part within is damaged, do not install but contact your supplier.

Do not disassemble, repair or modify the equipment. Contact your supplier for repair.

This product must be installed, connected and used in compliance with prevailing standards and/or installation regulations.

Do not exceed the device's ratings.

The unit must be installed in an enclosure or cabinet connected to the protective earth ground.

Electrically conductive pollution must be excluded from the cabinet in which the product is mounted.

Do not allow anything to fall through the case apertures and ingress the product.

Before any other connection is made, the protective earth ground terminal shall be connected to a protective conductor.

Protective conductor must be sized in compliance with local and national regulatory requirements.

Tighten all connections in conformance with the torque specifications. Periodic inspections are required.

High speed fuses (supplemental fuses in addition to branch circuit protective device), as listed in fusing sections, are mandatory to protect EPack Lite against load short circuit.

If opening of either the branch circuit protective device or the high-speed fuses (supplemental fuses) occurs, the product shall be examined by suitably qualified personnel and replaced if damaged.

A high-speed fuse (supplemental fuses in addition to branch circuit protective device) or a double protection fuse as listed in fusing sections is mandatory for 85Vac to 550Vac auxiliary supply.

If opening of any fuses or branch circuit protection device that supply the 85Vac to 550Vac auxiliary supply occurs, check the wiring first. If the wiring is not damaged, do not replace the fuse and contact the manufacturer's local service center.

The maximum voltage between any pole of the 85Vac to 550Vac auxiliary supply and all other terminals shall be lower than 550Vac.

The "24V auxiliary supply" is an SELV circuit. The supply Voltage must be derived from a SELV or PELV circuit.

The I/O Input & Output, the Communications ports are SELV circuit. They must be connected to SELV or PELV circuit.

Failure to follow these instructions will result in death or serious injury.

DANGER

HAZARD OF ELECTRICAL SHOCK, EXPLOSION OR ARC FLASH

The relay output and the fuse holders contacts are compliant to the SELV requirements; they can be connected to SELV, PELV circuit or to voltage up to 230V (maximum value of rated operational voltage to earth:230V)

Ensure all cables and wiring harness are secured using a relevant strain relief mechanism.

Respect electrical installation requirements to ensure optimum IP rating.

Close doors and plug-in terminals before turning on power to this equipment.

Use appropriate safety interlocks where personnel and/or equipment hazards exist.

Failure to follow these instructions will result in death or serious injury.

DANGER

HAZARD OF FIRE

Select the product current rating greater than or equal to the MAXIMUM current of the load.

If SWIR is selected as Heater type, select the product current rating greater than or equal to 125% of MAXIMUM current of the SWIR load WITHOUT taking in account the inrush current.

With SWIR Load, if a fast response time is required, or if IHC firing mode has been selected, select SWIR (Infrared) as Heater type.

If SWIR is selected as Heater type, adjust the duration of the safety ramp (SafetyRamp), the cooling time of the load (SWIRLoadCoolingTime) and the value of SWIR Load Cooling Threshold to limit the RMS load inrush current SWIR to less than 2.5 times the product current rating.

This product does not contain any branch-circuit protection, the installer must add branch-circuit protection upstream of the unit.

Branch circuit protection shall be selected according to maximum current in each phase and must be rated in compliance with local and national regulatory requirements.

Power connections: The cables must be rated 90°C stranded copper only, the cross section must be selected according to the branch circuit protection rating.

The cables used to connect the EPack Lite's auxiliary supply and voltage reference must be protected by branch-circuit protection. Such branch-circuit protection must comply with local and national regulatory requirements.

Connection of two conductors in the same terminal is not permitted, partial or total loss of connection may create an overheat of the terminals.

The conductor stripping length shall be as stated in electrical installation.

Respect mechanical installation requirements to allow heatsink to dissipate power.

At commissioning ensure that under maximum load condition, the ambient temperature of the product will not exceed the limit stated in that manual.

Heat-sink must be cleaned regularly. Periodicity depends on the local environment, but should not exceed 1 year.

Failure to follow these instructions will result in death or serious injury.

WARNING

UNINTENDED EQUIPMENT OPERATION

Do not use the product for critical control or protection applications where human or equipment safety relies on the operation of the control circuit.

Signal and power voltage wiring must be kept separate from one another. Where this is impractical, all wires must be rated to the power voltage & shielded cables are recommended for signal wiring.

This product has been designed for environment A (Industrial). Use of this product in environment B (domestic, commercial and light industrial) may cause unwanted electromagnetic disturbances in which cases the installer may be required to take adequate mitigation measures.

For Electromagnetic Compatibility, panel or DIN rail to which product is attached shall be grounded.

Observe all electrostatic discharge precautions before handling the unit.

At commissioning, ensure correct product configuration.

At commissioning, ensure cybersecurity robustness of the installation.

Failure to follow these instructions can result in death, serious injury or equipment damage.

CAUTION

HOT SURFACE RISK OF BURNS

Allow heatsink to cool before servicing.

Do not allow flammable or heat-sensitive parts in the immediate vicinity of heatsink.

Failure to follow these instructions can result in injury or equipment damage.

NOTICE

North America (NA) Regulations

For USA & Canada EPack 125A fuse holder terminal capacity is rated UL 1/0AWG, this may decrease the maximum Load current according to standard, ambient temperature, wiring arrangement.

Failure to follow these instructions can result in non-compliance to NA regulations

EPack™ Lite

Single Phase Power Controller



DVD CONTENTS AND INSTALLATION

Product documentation. The documentation on this DVD is in PDF format which requires the use of a suitable reader to view it. The English language version of the latest version of Adobe Acrobat for Microsoft® Windows® may be installed from this DVD.

DOCUMENTATION

EPack Lite Controller User Guide HA033542

Eurotherm: International sales and support www.eurotherm.com

Contact Information
Eurotherm Head Office
Faraday Close,
Durrington,
Worthing, West Sussex,
BN13 3PL
Sales Enquiries
T +44 (0)1903 695888

Worldwide Offices
www.eurotherm.com/worldwide

General Enquiries
T +44 (0)1903 268500



Scan for local contacts



Eurotherm
by Schneider Electric

HA033161ENG Issue 4

Jan 2021

CN38904

© Copyright Eurotherm Limited 2021

Eurotherm by Schneider Electric, the Eurotherm logo, Chessell, EurothermSuite, Mini8, Eycan, Eyris, EPower, EPack, nanodac, versadac, optivis, Foxboro and Wonderware are trademarks of Schneider Electric, its subsidiaries and affiliates. All other brands may be trademarks of their respective owners.

All rights are strictly reserved. No part of this document may be reproduced, modified, or transmitted in any form by any means, nor may it be stored in a retrieval system other than for the purpose to act as an aid in operating the equipment to which the document relates, without the prior written permission of Eurotherm Limited.

Eurotherm Limited pursues a policy of continuous development and product improvement. The specifications in this document may therefore be changed without notice. The information in this document is given in good faith, but is intended for guidance only. Eurotherm Limited will accept no responsibility for any losses arising from errors in this document.

ELECTRICAL INSTALLATION

Supply and Load Wiring

Connections are summarized below for quick reference - Do not attempt electrical installation without referring to the EPack Lite Controller User Guide HA033542.

16A to 32A and 40A to 63A

32A shown; 63A similar

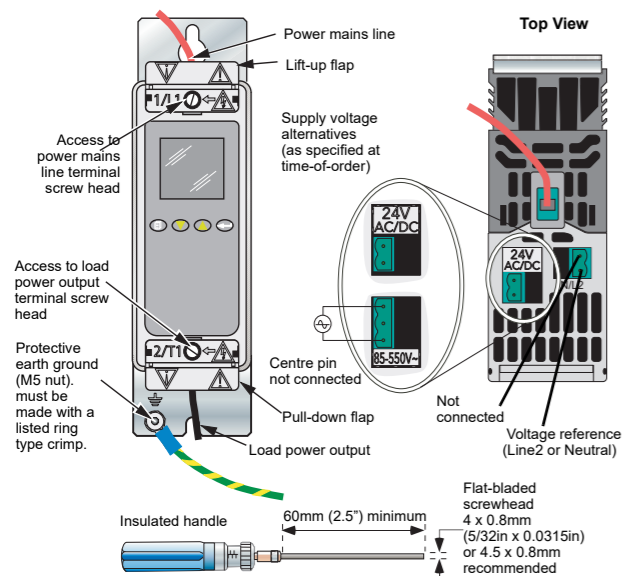

EPackLite rating (Amps)	Exposed conductor length mm (inch)	Cable diameter max mm (inch)
80A to 125A	20 to 23 (0.79 to 0.91)	8.5 (0.33)
16A to 63A	9 to 11 (0.35 to 0.43)	8.5 (0.33)

80A to 125A Units

80/100A shown; 125A similar

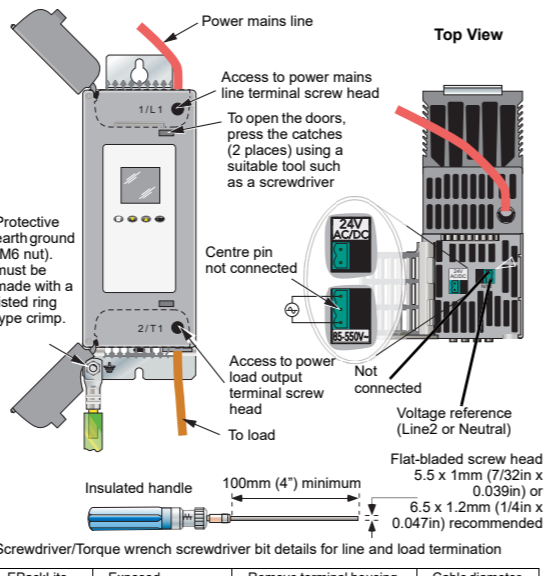

EPackLite rating (Amps)	Exposed conductor length mm (inch)	Remove terminal housing breakaway part? mm (inch) cable diameter	Cable diameter maximum mm (inch)
80A to 125A	20 to 23 (0.79 to 0.91)	Yes, for cables greater than 9 (0.35)	17.5 (0.69)

IO Wiring

A 63A EPack Lite is shown below. Units for other current ratings are of similar appearance and are wired in the same manner.

Use a 0.6 x 3.5mm screwdriver for pluggable connectors

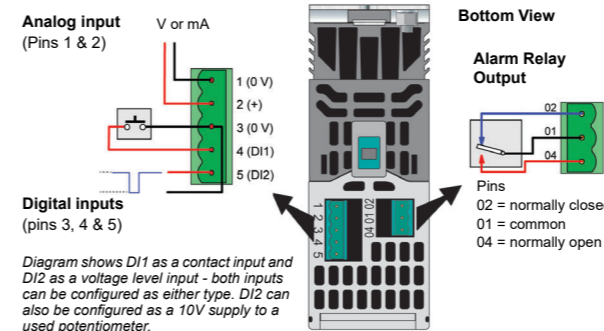

Analog Input	Digital Inputs	Relay Output
Use the Adjust > Ana_in type menu to configure the input range as 0 to 10V, 1 to 5V, 2 to 10V, 0 to 5V, 0 to 20mA 4-20mA Selecting a mA range automatically places a suitable shunt resistor in the circuit, there is no need to fit external components.	Absolute maxima for externally applied signals: $\pm 30V$ or $\pm 25mA$ Contact input ranges: Open: 800Ω to ∞ Undefined: 450Ω to 800Ω Closed: 0Ω to 450Ω Source current 10mA min. 15mA max.	Voltage level input ranges: High: +11V to +30V (with current greater than 6mA) Low: -3V to +5V (with current 2mA to 30mA) or +5V to +11V (with current of 2mA) User potentiometer supply (DI2 only): 10.2V ± 2%, 10mA; Pot.range: 2kΩ to 10kΩ ±20%
		Switching characteristics (resistive loads): Vmax = 264V RMS Vmin = 5V Imax = 2A RMS Imin = 10mA RMS

Connection Details

Terminals	Product rating	Terminal capacity ^a		Wire Type	Torque	Comments
		mm ²	AWG			
Supply voltage (1/L1) and Load supply (2/T1)	16A to 63A	1.5 mm ² to 16 mm ²	AWG 14 to AWG 6 ^b	Stranded copper rated 90°C (194°F)	1.7Nm (15lb in)	Flat-bladed screwdriver 4 x 0.8mm (5/32in x 0.0315in) or 4.5 x 0.8mm
	80A to 125A	10 mm ² to 50 mm ²	AWG 8 to AWG 2/0		5.6Nm (50lb in)	Flat-bladed screwdriver 5.5 x 1mm (7/32in x 0.039in) or 6.5 x 1.2mm (1/4in x 0.047in)
Protective earth ground	16A to 63A	M5 ring-type crimp terminal		Stranded copper rated 75°C (167°F)	2.5Nm (22lb in)	U.L.: Listed ring-type crimp terminal must be used
	80A to 125A	M6 ring-type crimp terminal			5.6Nm (50lb in)	U.L.: Listed ring-type crimp terminal must be used
Neutral reference (N/L2) (2-ways / 1 connected) Supply (24V ac/dc) (2-way) Supply (85V-550Vac) (3-way) I/O connector (5-way) Relay connector (3-way)	All	0.25 mm ² to 2.5 mm ²	AWG 24 to AWG12		0.56Nm (5lb in)	Flat-bladed screwdriver 3.5 x 0.6mm (1/8in x 0.0236in)

a. AWG (American Wire Gauge) for USA and Canada (according to cUL standard); section in mm² for IEC countries (according to IEC/EN standard).
b. Use U.L. listed crimp terminals YEV4CP20X75FX, from Burydy (E9498), to connect AWG 4 wire to terminal.

TECHNICAL SPECIFICATION STANDARDS

This product is designed and produced to comply with:

Countries	Standard symbol	Standard details
European community		EN60947-4-3:2014 (identical to IEC60947-4-3:2014) Low-voltage switchgear and controlgear - Part 4-3: Contactors and motor-starters - AC semiconductor controllers and contactors for non-motor loads. Declaration of conformity available on request.
USA and Canada		USA: UL60947-4-1 Canada: CAN/CSA C22.2 NO.60947-4-1-14 Low-Voltage Switchgear and Controlgear - Part 4-1: Contactors and Motor-Starters – Electromechanical Contactors and Motor-Starters. U.L. File N° E86160.
Australia		Regulatory Compliance Mark (RCM) to Australian Communication and Media Authority. Based on compliance to EN60947-4-3:2014.
China	/	Product not listed in catalog of products subject to China Compulsory Certification (CCC)

INSTALLATION CATEGORIES

	Overvoltage category	Rated impulse withstand voltage (U _{imp})	Rated insulation voltage (Ui)	Maximum value of rated operational voltage to earth
Communication	II	0.5 kV	50V	50V
Standard IO	II	0.5 kV	50V	50V
Relays	III	4 kV	230V	300V
Module power	III	6 kV	500V	300V

Weight	16 to 32A units	800g + user connectors
	40 to 63A units	950g + user connectors
	80 to 100A units	1800g + user connectors
	125 A units	2500g + user connectors

MECHANICAL INSTALLATION

16A, 32A, 40A and 63A unit dimensions

40/63A shown

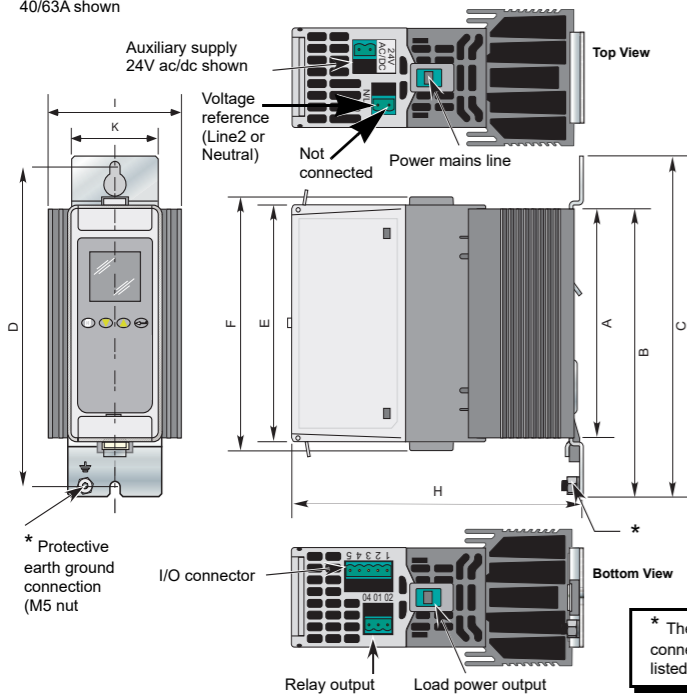

80A, 100A and 125A unit dimensions

125A shown

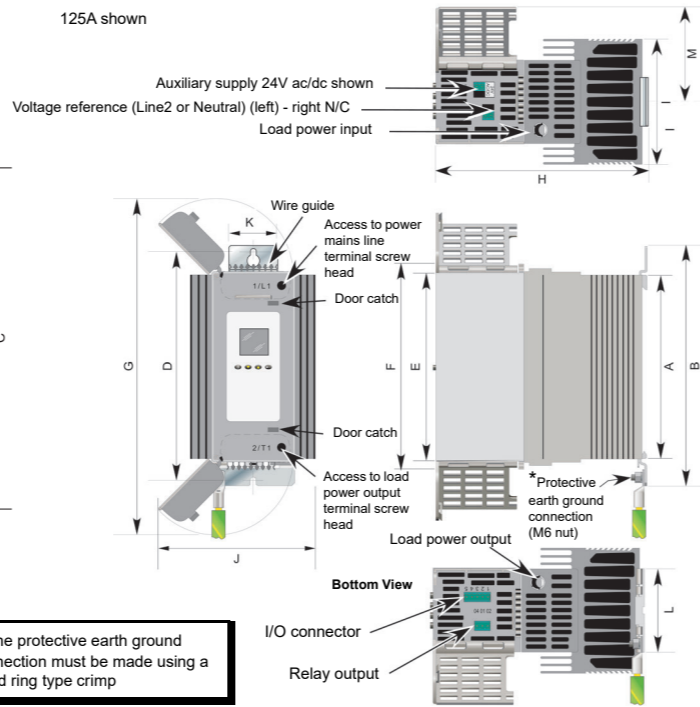

* The protective earth ground connection must be made using a listed ring type crimp

EMC

EMC immunity tests EN60947-4-3:2014
EMC emission tests EN60947-4-3:2014

Auxiliary supply

Frequency range: 47 to 63Hz
Rated control supply voltage (Us): 24V ac/dc (+20% -20%), or 100 to 500V (+10% -15%)
Power requirement: 24Vdc: 12W
24Vac: 18VA
500Vac: 20VA

Power

Frequency range: 47 to 63Hz
Rated operational voltages (Ue): 100 to 500V (+10% -15%)
Rated operational currents (Ie): 16 to 125A
Power Dissipation: 1.3W per Ampere, per phase
Short circuit protection: By external supplemental fuses (high speed fuse) See User Manual HA033542
Rated conditional short-circuit current: 100kA (co-ordination type 1)

Utilization categories (Load types)
AC51: Non-inductive or slightly inductive loads, resistance furnaces
AC-55b: Switching of incandescent lamps
AC-56a: Transformer Primary

Duty cycle: Uninterrupted duty / continuous operation
Device form: Designation Form 4 (Semiconductor controller)

Heater types: Non variable resistive loads
SWIR Loads

Overload conditions

AC-51: 1 x Ie continuous
AC-55b: 1 x Ie continuous
AC-55b: 2.5 x Ie - 100ms
AC-56a: 1 x Ie continuous

Operator Interface

Display: 1.5" square TFT colour display allowing viewing of selected parameter value in real time, plus configuration of instrument parameters for users with adequate access permission

Pushbuttons: Four pushbuttons provide page and item entry and scroll facilities

Environment

Temperature limits: Operating: 0°C to 45°C at 1000m
0°C to 40°C at 2000m
Storage: -25°C to 70°C
Altitude: 1000m maximum at 45°C
2000m maximum at 40°C
Humidity limits: 5% to 95% RH (non-condensing)
Atmosphere: Non-explosive, non-corrosive, non-conductive
Pollution degree: Pollution degree 2

Degree of protection (CE)¹: 16A to 63A units IP 10 (EN60529)
80A to 125A units IP 20 (EN60529)

Enclosure type ratings (UL): All units Open type
External wiring General: Must comply with IEC60364-1 and IEC60364-5-54 and all applicable local regulations.
UL: Must comply with NEC and all applicable local regulations. Cross sections must comply with NEC, Article 310 Table 310-16.

Temperature rating: Power conductors: 90°C, other wires 75°C
Shock: According to EN60068-2-27 and IEC60947-1 (Annex Q, Category E)
Vibration: According to EN60068-2-6 and IEC60947-1 (Annex Q, Category E)

1. To maintain the IP rating of the unit, the wiring and installation requirements defined in the Cable connection specification shown in the 'Installation' section must be adhered to.

Symbols

One or more of the symbols below may appear as part of the instrument labeling

	Protective conductor		Risk of electric shock
	AC supply only		Precautions against static electrical discharge must be taken when handling this unit
	Underwriters laboratories listed mark for Canada and US		Refer to manual for instructions
	Do not touch heatsink, Hot Surface		CE mark. Indicates compliance with the appropriate European Directives
	EAC (EurAsian Conformity) customs union mark of conformity		Regulatory compliance mark (RCM) to Australian Communication and Media Authority

Part Name	有害物質 Hazardous Substances					
	鉛 (Pb)	汞 (Hg)	鎘 (Cd)	六價鉻 (Cr (VI))	多溴聯苯 (PBB)	多溴二苯醚 (PBDE)
金屬部件 Metal parts	0	0	0	0	0	0
塑料部件 Plastic parts	0	0	0	0	0	0
電子件 Electronic	X	0	0	0	0	0
触点 Contacts	0	0	0	0	0	0
線纜和線纜附件 Cables & cabling accessories	0	0	0	0	0	0

本表格根據SJ/T11364的規定編制。
O: 表示該有害物質在該部件所有均質材料中的含量均在GB/T 26572規定的限量要求以下
X: 表示該有害物質至少在該部件的某一均質材料中的含量超出GB/T 26572規定的限量要求。

This table is made according to SJ/T11364.
O: Indicates concentration of hazardous substance in all of the homogeneous materials for this part is below the limit stipulated in GB/T 26572.
X: Indicates concentration of hazardous substance in at least one of the homogeneous materials used for this part is above the limit stipulated in GB/T 26572.

Signed (Kevin Shaw, R&D Director): *[Signature]* Date: 7th December 2017

IA029470U745 Issue 5 December 2017

BULKHEAD MOUNTING

32A and 63A units

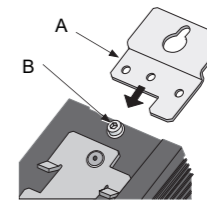

80A, 100A and 125A

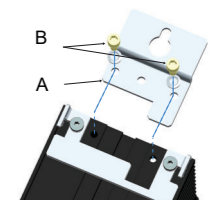

For Bulkhead mounting, fit the upper bracket 'A' to the rear of the unit by removing screw 'B' and associated shakeproof washer, offering the bracket up to the unit, and then securing it using screw 'B' ensuring that the bracket is correctly oriented (as shown) and that the shakeproof washer is fitted between the screw head and the bracket.

The relevant screwdriver should have a 3mm AF hexagonal bit. The recommended tightening torque is 1.5Nm (1.1 lb-ft).

E-PackLite dimensions all types

Dimensions for E-PackLite Controllers of different current ratings

Label	Dimensions	16A to 32A	40A to 63A	80A to 100A	125A
Height					
A	of heatsink	117mm (4.61in)	117mm (4.61in)	175.46mm (6.91in)	175.46mm (6.91in)
B	with DIN rail	147mm (5.79in)	147mm (5.79in)	231.00mm (9.09in)	231.00mm (9.09in)
C	with wall mount bracket	174mm (6.85in)	174mm (6.85in)		
D	Fixing centres of wall mount bracket	163.5mm (6.44in)	163.5mm (6.44in)	218.25mm (8.59in)	218.25mm (8.59in)
E	of front panel	121mm (4.76in)	121mm (4.76in)	182.00mm (7.17in)	182.00mm (7.17in)
F	including connectors	129.2mm (5.09in)	129.2mm (5.09in)	197.6mm (7.78in)	197.6mm (7.78in)
G	with doors open	N/A	N/A	321.23 (12.65in)	321.23 (12.65in)
Depth					
H		136.2mm (5.36in)	173.3mm (6.23)	202.1mm (7.96in)	202.1mm (7.96in)
Width					
I	of heatsink	51mm (2.01in)	72mm (2.83in)	80mm (3.15in)	120mm (4.72in)
J	with doors open	N/A	N/A	130.5mm (5.14in)	150.5mm (5.92in)
K	of wall mounting bracket	46.7mm (1.84in)	46.7mm (1.84in)	46.7mm (1.84in)	46.7mm (1.84in)
L	with doors closed	N/A	N/A	80mm (3.15in)	80mm (3.15in)
M	from centre of heatsink (doors open)	N/A	N/A	90.5mm (3.56in)	90.5mm (3.56in)

N/A = Not applicable