

6000 Series

Data Management

The most advanced, easy to use and versatile data recording solution available today



Easy Secure Adaptable

Eurotherm[®]

by **Schneider** Electric

Easy Secure Adaptable



6000 Series Data Management

Ensure your precious process data is kept safe with our range of state-of-the-art recorders and data management software. Along with some of the best, proven recording and archiving strategies, Eurotherm recorders offer a wealth of functions including batch, audit trail, electronic signatures and remote viewing/operation – ensuring operational efficiency is optimised and enabling you to convert data into the information required to add value to a process.

Brightness and Clarity

High screen definition always ensures maximum clarity as the 6000 Series uses state of the art digital TFT display technology. A separate display processor always optimises screen refresh rates to ensure 'Operator' efficient viewing of all screens.

- High resolution XGA display
- Digital display technology
- Bright and sharp images
- 16-bit colour
- 8 Hz trend speed update

Touch Screen Display

The 6000 Series HMI is easy and intuitive to use ensuring faster productivity and minimal learning requirements. It also incorporates a 'Pop Up' full 'QWERTY' keyboard to facilitate easy data or message entry.

- No complicated button presses
- Create operator buttons anywhere on display
- Intuitive drop-down menus
- Consistent navigation
- Pre-defined 'Soft' keys
- Integral stylus for 6100A and 6180A

Easy

The features and functions of this innovative range have been designed with 'ease of use' in mind. Taking advantage of the latest technologies while maintaining a secure environment, the 6000 Series feels familiar and is easy to use.

Secure

Security is an integral part of the 6000 Series. Data logging, data archiving and user access are all designed to give you peace of mind while still providing 'ease of use'. Process data and Metadata values are continually logged to the large, internal, non-volatile FLASH memory. Records are stored in a secure, binary, check summed format to protect data integrity.

Adaptable

The 6000 Series offers much more than just secure data recording. They provide many options that can be used in stand alone applications or can be easily integrated into a wider system.

Adaptable functionality incorporated in the 6000 instruments will meet the most demanding of solution requirements. With their ease of use and configuration, you can be sure to maximise your return on investment.

EASY

Easy to install, Easy to configure, Easy to use

The features and functions of this innovative range have been designed with 'ease of use' in mind. Taking advantage of the latest technologies while maintaining a secure environment, the 6000 Series feels familiar and is easy to use.

Easy fit to your process

The 6000 Series fits a wide spectrum of applications by offering fully featured software options and flexible I/O, which can be added to at any time. A unique 'trial mode' feature removes the constraints of the purchased options, allowing you to simply 'try before you buy'.

- Extensive maths, totalisers, counters, timers, groups, log scales, batch
- Multiple views - standard and custom
- Up to 48 input channels
- Up to 27 relays and 24 event inputs
- Compact Flash or USB memory card

Built-in Data Protection and Traceability

The 6000 Series HMI is easy and intuitive to use ensuring faster productivity and minimal learning requirements. It also incorporates a 'Pop Up' full 'QWERTY' keyboard to facilitate easy data or message entry.

- Electronic lockable media flap on 6100A and 6180A
- Audit Trail for 21CFR Part 11 and Nadcap
- Unlimited, unique user names and passwords
- Recorded login
- Multiple archiving strategies
- Selectable internal Flash memory size
 - up to 96Mb for history (12 million samples) in 6100A and 6180A

Easy Communications

Communications flexibility is the cornerstone of solutions in today's challenging Global market, where data is required to be communicated locally and/or globally. The 6000 Series meets these challenges by offering a wide range of communications options.

- 10/100baseT auto-sensing Ethernet as standard
- 6100A/6180A uses 2 serial ports – 232/422/485
- 6100XIO/6180XIO uses 2 serial ports – 422/485
- Modbus TCP and RTU master and slave
- FTP client and server
- EtherNet/IP server
- DHCP, BootP or fixed IP addressing
- SNTP client and server
- Remote viewing, operation and configuration
- Remote software upgrade
- Centralised security using Security Manager

Local Printing

Locating a 'local' printer to the 'job' or work in progress can sometimes be a primary criteria. This requirement is met by the 6100A and 6180A in an easy to configure manner.

- Local serial ticket printer for batch/event reporting

USB 'Plug and Play'

'Plug and Play' peripherals allow the 6000 Series to be connected in an easy and familiar manner so you can configure and operate the 6000 Series based on specific application requirements.

- Keyboard
- Mouse
- Memory Stick
- Bar code scanner

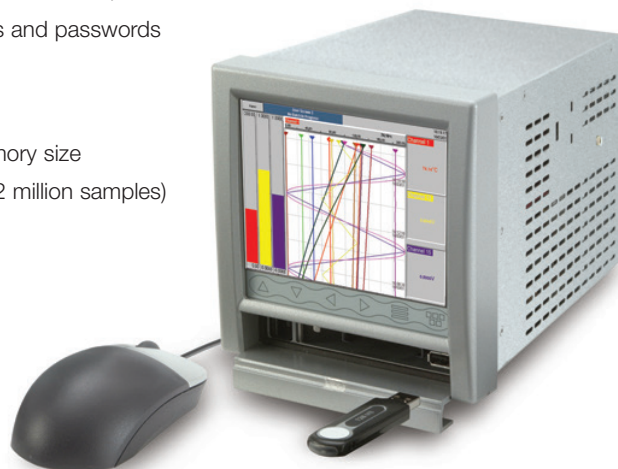

Secure

Your data has a value and we can give you peace of mind

Security is an integral part of the 6000 Series. Data logging, data archiving and user access are all designed to give you peace of mind while still providing 'ease of use'. Process data and Metadata values are continually logged to the large, internal, non-volatile FLASH memory. Records are stored in a secure, binary, check summed format to protect data integrity.

User Access Controls

Access to the 6000 instruments are controlled using an unlimited amount of unique user names and passwords. Each user can be set up with specific access rights - this not only ensures users only get access to the areas they need, it also simplifies operation as dynamic menus show only items the user can access.

Active Directory

Active Directory is a Microsoft® utility intended for User Access Administration of PCs. It is a tool used by the IT administrators to manage user access across the company wide network. It allows users to be given access according to their functions by allocating them to a group with defined privileges. It also includes the necessary features such as password expiry, auto-logout, minimum length password, etc. It allows the users to manage their password from any node on the system.

Electronic Signatures

The 6000 Series support Electronic Signatures in accordance with 21 CFR Part 11. All user actions can be configured to require signing or signing and authorisation. The ability to sign or authorise is configured on a user by user basis and incorporates signature element controls. Unique users are ensured by retiring and not deleting accounts.

- Electronic signing and authorisation
- User specific access according to authority level
- Signature element controls - password expiry, minimum password length, automatic log-off, automatic disabling and notification on failed login attempts
- Unlimited, unique user accounts and passwords

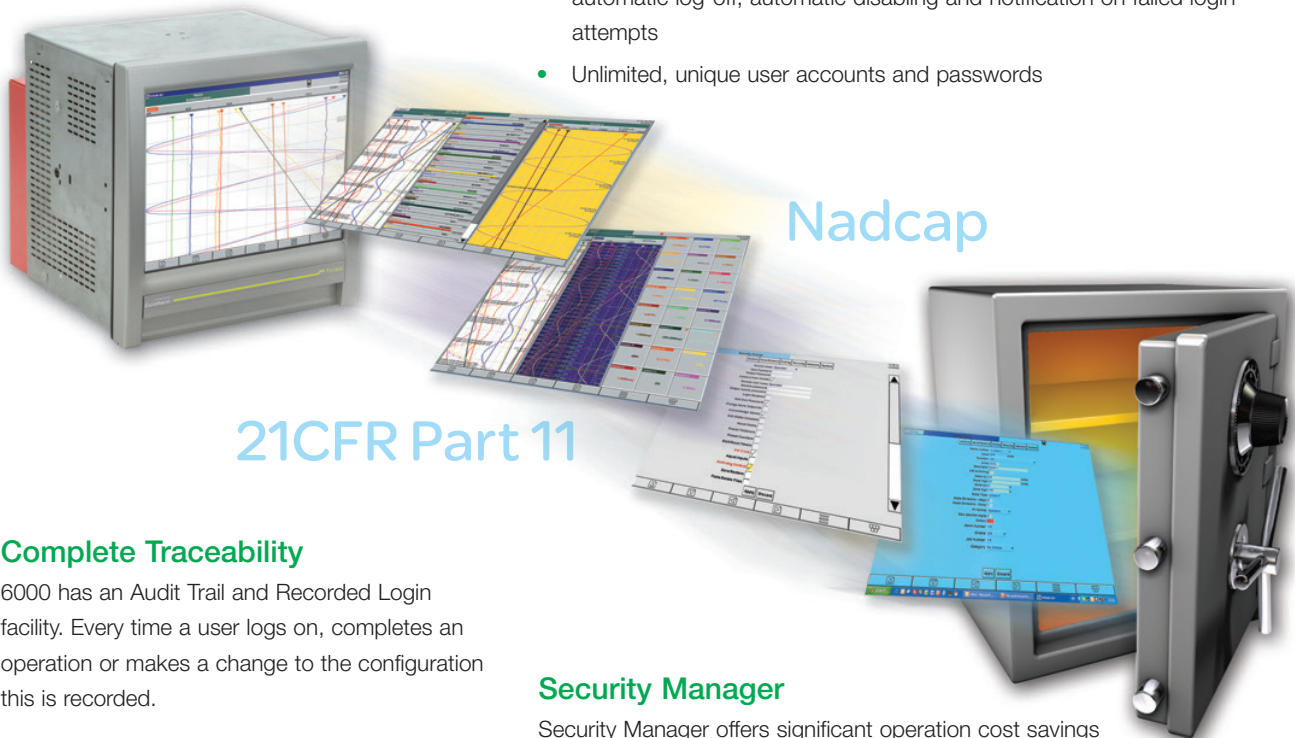

Complete Traceability

6000 has an Audit Trail and Recorded Login facility. Every time a user logs on, completes an operation or makes a change to the configuration this is recorded.

The Audit Trail is time-stamped and incorporates the operator details along with the changes made. It is stored with the process data and cannot be modified or removed.

Security Manager

Security Manager offers significant operation cost savings and ease of use by providing maintenance of user accounts and passwords from one or multiple locations. If a user needs to change their password they can do so on a local instrument or PC and this will be automatically distributed across all systems to which they have access.

Adaptable

Adaptable features, flexible solution ... more than a box

The 6000 Series offers much more than just secure data recording. They provide many options that can be used in stand alone applications or can be easily integrated into a wider system.

Adaptable functionality incorporated in the 6000 instruments will meet the most demanding of solution requirements. With their ease of use and configuration, you can be sure to maximise your return on investment.

Communications Made Easy

The 6000 Series can be a Modbus Master and Slave over both Serial and Ethernet connections at the same time. Slave devices can be connected to any of the ports and data recorded and made available to supervisory systems over the Ethernet network. Custom screens can be easily created to give the operator the best view of the process and easier operation of connected devices via the touch screen display.

- 10/100baseT Ethernet
- EtherNet/IP Server
- Modbus master and slave
- Dynamic Host Configuration Protocol (DHCP)
- Alarm/event notification via email/SMS
- Remote viewing, operation and configuration
- Automatic printing functionality
- Up to 12 independent Groups (effectively 12 recorders in one box)
- Adaptive recording to store max and min values at 8Hz- at slower recording rates
- Simple reporting

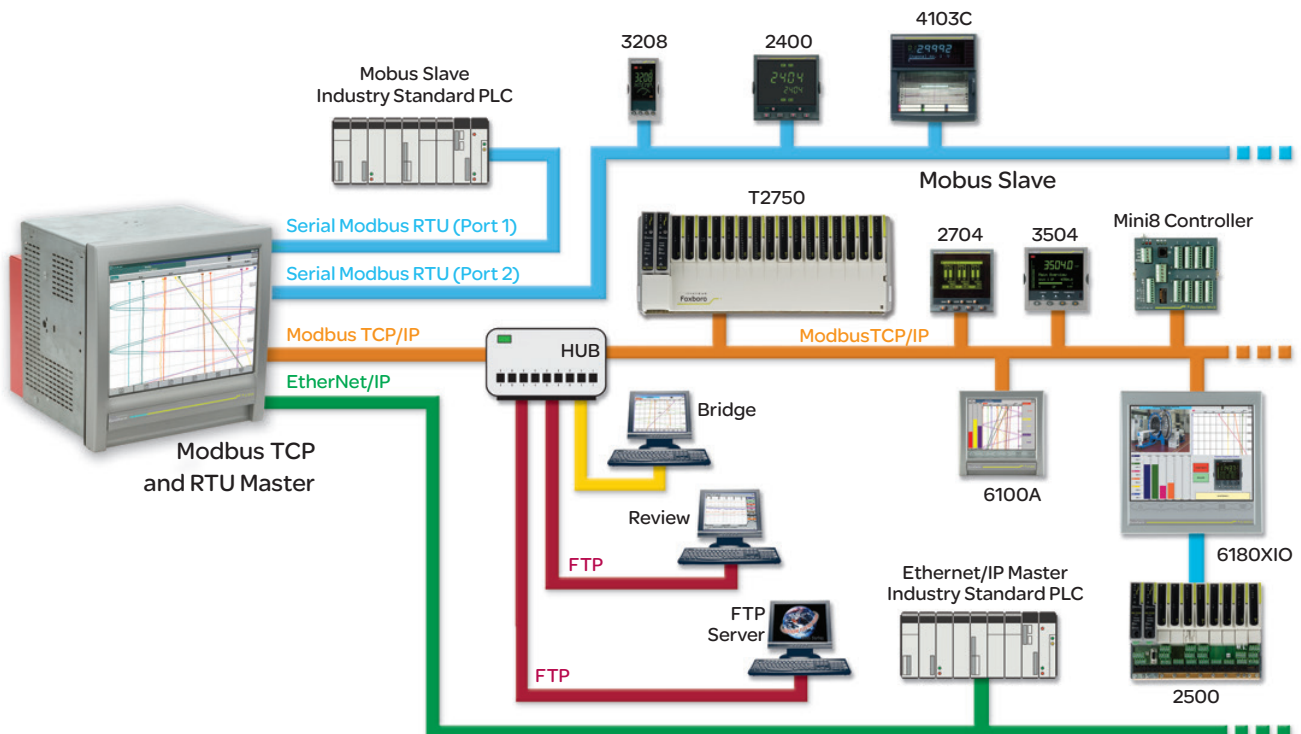

Success stories commercial benefits

CASE STUDY Helping manage air quality in the Austrian Tyrol



Eurotherm have been supplying environmental measurement solutions for air quality and forest protection to the Government department responsible for the Austrian Tyrol since 2004.

Customer Challenge

To reduce CO2 emissions by 50%.

Solution

- 6180A graphic recorder
- Bridge remote access software
- Review and Review QuickChart secure data storage and viewing

Customer Benefits

- A sophisticated solution that outstrips our competitors
- Out of 24 mobile environment measurement stations in the Tyrol most are equipped with our 6180A graphic recorder
- With this solution the Tyrol Government are able to fully and accurately collect and manage air quality environmental data across the entire region helping to meet their high targets for CO2 emission reduction

CASE STUDY Unique benefits for crucial healthcare instrument disinfection



Our control and monitoring 6100A Chart Recorder, collects and verifies data to prove that all disinfection processes are 100 percent accurate and complete.

Customer Challenge

Our customer, a leading manufacturer in the field of Endoscope, Laboratory and Surgical Instrument Decontamination equipment wanted to improve their monitoring capabilities for decontamination of equipment. Improved monitoring ultimately reduces the number of illnesses and deaths.

Solution

- Eurotherm 6100A chart recorder data monitoring solution
- T2550 PAC utilising endoscope Patency control with independent data verification from the 6100A recorder

Customer Benefits

- Unique solution to the healthcare industry
- Data verification – independent from the washer disinfectant microprocessor
- Satisfies current and future drafted global regulations for monitoring, detailed traceability and validation

CASE STUDY Aviation Industry – superb integration with current systems and accreditation preparation



With our approach to information management and control, Eurotherm improves operating efficiency processes for Nadcap accreditation for a leading design company in aircraft training equipment.

Customer Challenge

Improve operating efficiency and remove as much paperwork as possible to reduce source errors, in accordance with Nadcap accreditation requirements.

Solution

- 6000 series recorders with Eurotherm supplied SCADA solution
- Created a bespoke custom database, integrated with existing process plant
- Single point of storage for process information

Customer Benefits

- No disruption to proven process operation
- Additional recorder instruments provide security and process audit capabilities: Vital for Nadcap accreditation
- Progressive implementation to manage costs
- Better quality information means improved productivity and faster return on investment
- These combined savings serve to reduce overheads and increase profit

For the full stories and all our successes go to www.eurotherm.com/success

Real-world applications

HMI functionality can be used to provide a total solution environment for secure recording and operator interface. Combining the adaptable features with ease of implementation, the 6000 Series is the first choice to provide this functionality.



Batch

6000 Series has powerful batch functionality and, combined with its groups, can run up to 12 simultaneous batches. Batches can be started and stopped independently and actions (e.g. printing a report or driving a relay) triggered by the start or stop of a batch. Each batch has up to 10 fields to enter data about the batch. These can be stored or entered by the operator on batch start manually or using a USB bar code scanner. Start/Stop times Elapsed Time and Field1 of all batches can be seen in the Batch Summary view.

Using the groups and the batch functionality the 6000 can easily be configured to manage multiple batches or multiple zones within a machine.

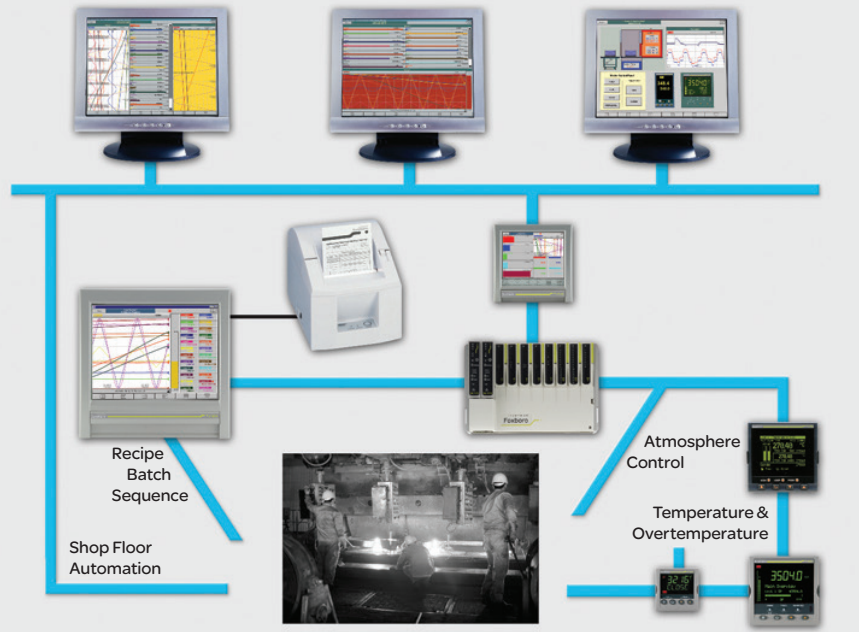

Extended Input Capability

Each 6000 can communicate with up to 32 slave devices, providing up to 176 inputs. These process values can be divided between up to 12 different groups to provide sensible viewing and reporting of data.

Slave devices could be used for:

- Additional data acquisition
- To provide operators remote access to legacy product data
- Combined recording and control functionality

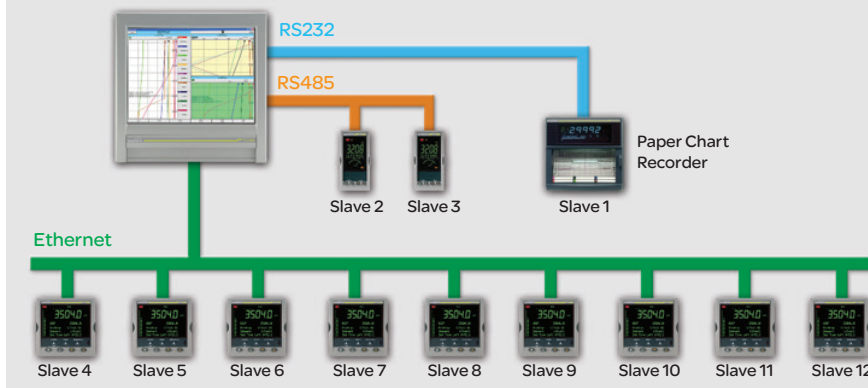

Sterilisation Process

- Lethality (F0) calculation
- Automatic batch start on event
- Batch reporting
- Automatic, local, batch printing for 'dirty' side
- Configurable to indicate pass/fail
- Easy operator interface

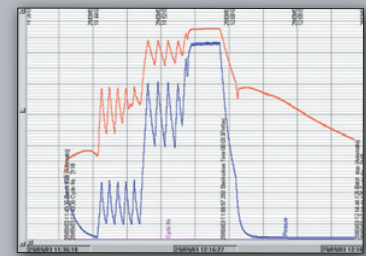

User Defined Screens

Whatever the application, the operator interface can be simplified using the Screen Builder to easily produce customised displays showing the specific process. The operator can start/stop batches, download parameters (e.g. control setpoint) and enter notes to be included with process record. Screens can contain standard elements (e.g. a trend or bar graph) along with imported image files, basic shapes and buttons to drive events.

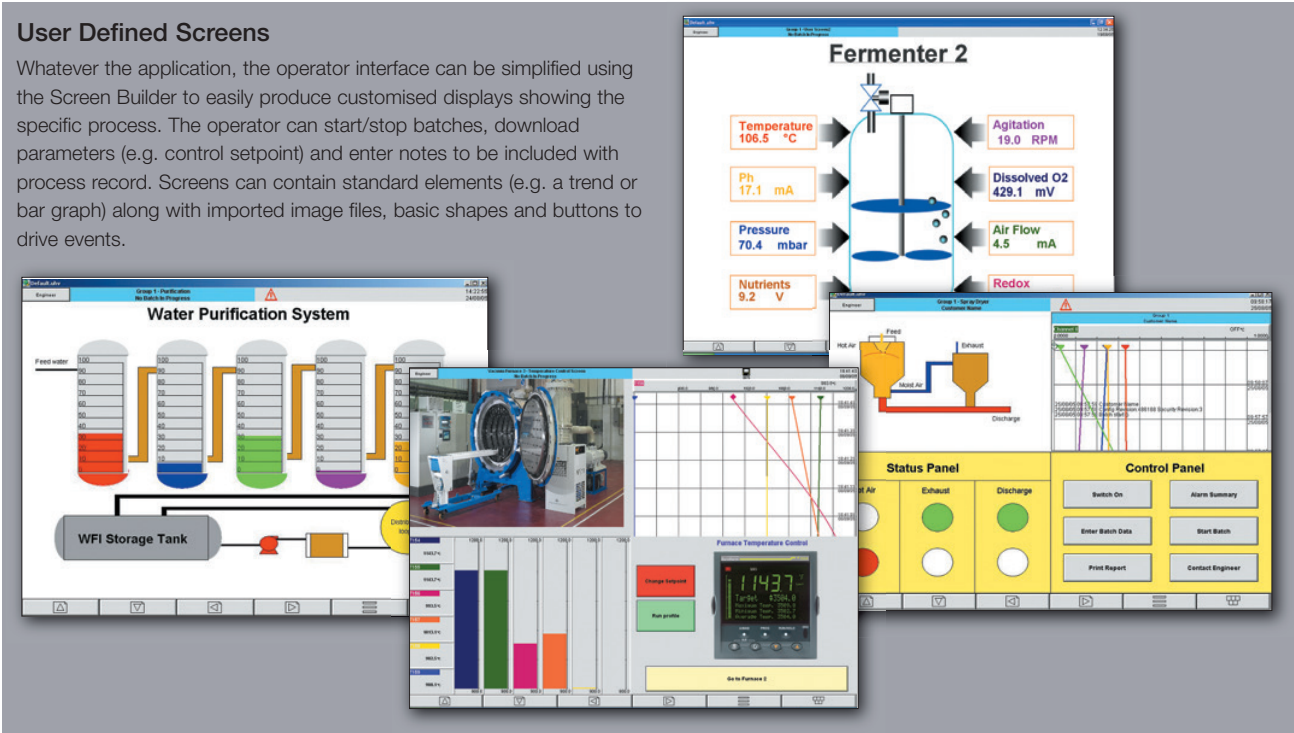

Remote Monitoring

Bridge software gives the user complete access to the 6000 instrument from a PC anywhere in the world with access to the local network. Security is maintained using unique user names and passwords. Recorders can be situated in remote locations and accessed when required to monitor status, access recorded data or change configuration – potentially saving a costly site visit. Combined with Master Communications the 6000 could also provide information to other local devices that would previously be inaccessible over the network.

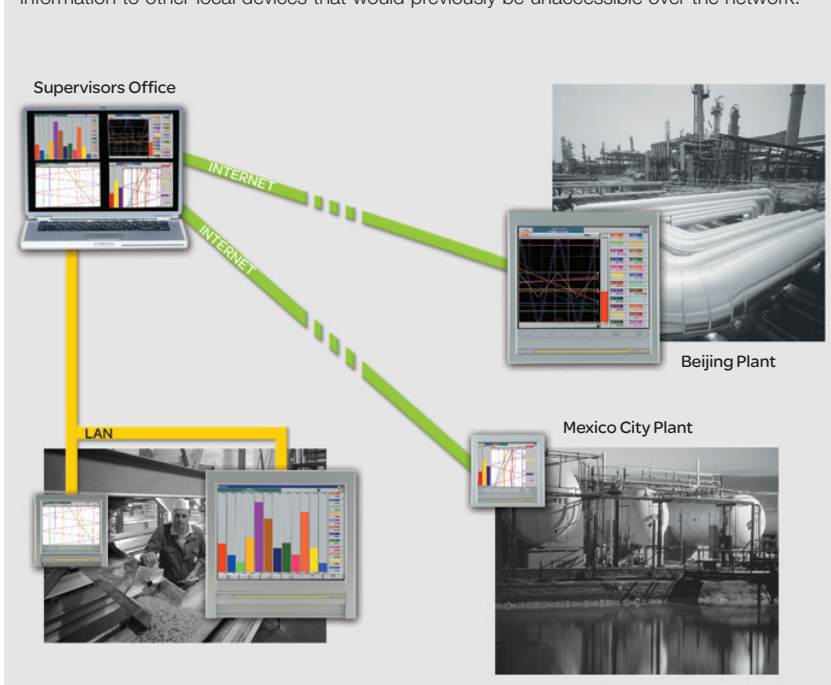

Environmental and Stability Chamber Monitoring

Secure recording in accordance with 21 CFR Part 11, remote operation and viewing, standard maths equations and multiple alarm/event alert strategies make the 6000 ideal for environmental monitoring applications.

- Local logging capability
- Easy integration into multiple room system
- Mean Kinetic Temperature (MKT) equation
- Selectable stability testing period
- Selectable sampling frequency
- Sophisticated alarm functionality
- SMS or email alerts triggered by alarms or events

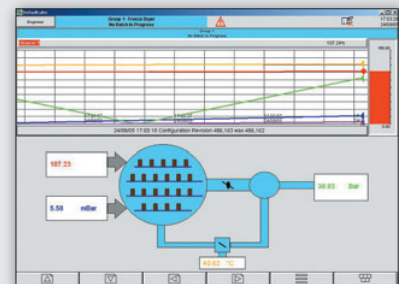

Get your data in the way you need it ...

The 6000 itself provides great flexibility in its application and it is supported by a number of PC-based tools to get data to you in the way you need it.

Bridge Software

Bridge software gives complete remote access to the recorders. The software can be installed on any number of PCs and can connect to multiple recorders via a local network, dial-up connection or the Internet. Each 6000 instrument can have 10 concurrent, independent, remote users connected to it and viewing live data from the recorder. Ease of operator use is maintained as the displays and operation at the PC are the same as on the 6000 instruments. Data security is maintained with the use of specific user names and passwords.

Review and Review QuickChart

Review software acts as an efficient and secure library for data from which charts can be reviewed, printed and exported to other PC packages if required. Archive files from a 6000 are stored in an encrypted, binary, check summed format and Review uses this format to enable chart view on a PC – ensuring integrity of both historical and new data. Review can access data from the recorder via a local network, dial-up connection, the Internet or directly from the 6000's removable media. Its Archive Management will help you to maintain growing data archives and manage files effectively.

Review QuickChart provides a very quick and simple way of viewing historical data. It recreates the chart on the PC – the user can then add comments if they wish and re-save the chart, securing the comments. QuickChart files can be viewed independently of the recorded process data and, as such, can be simply emailed for viewing by other users.



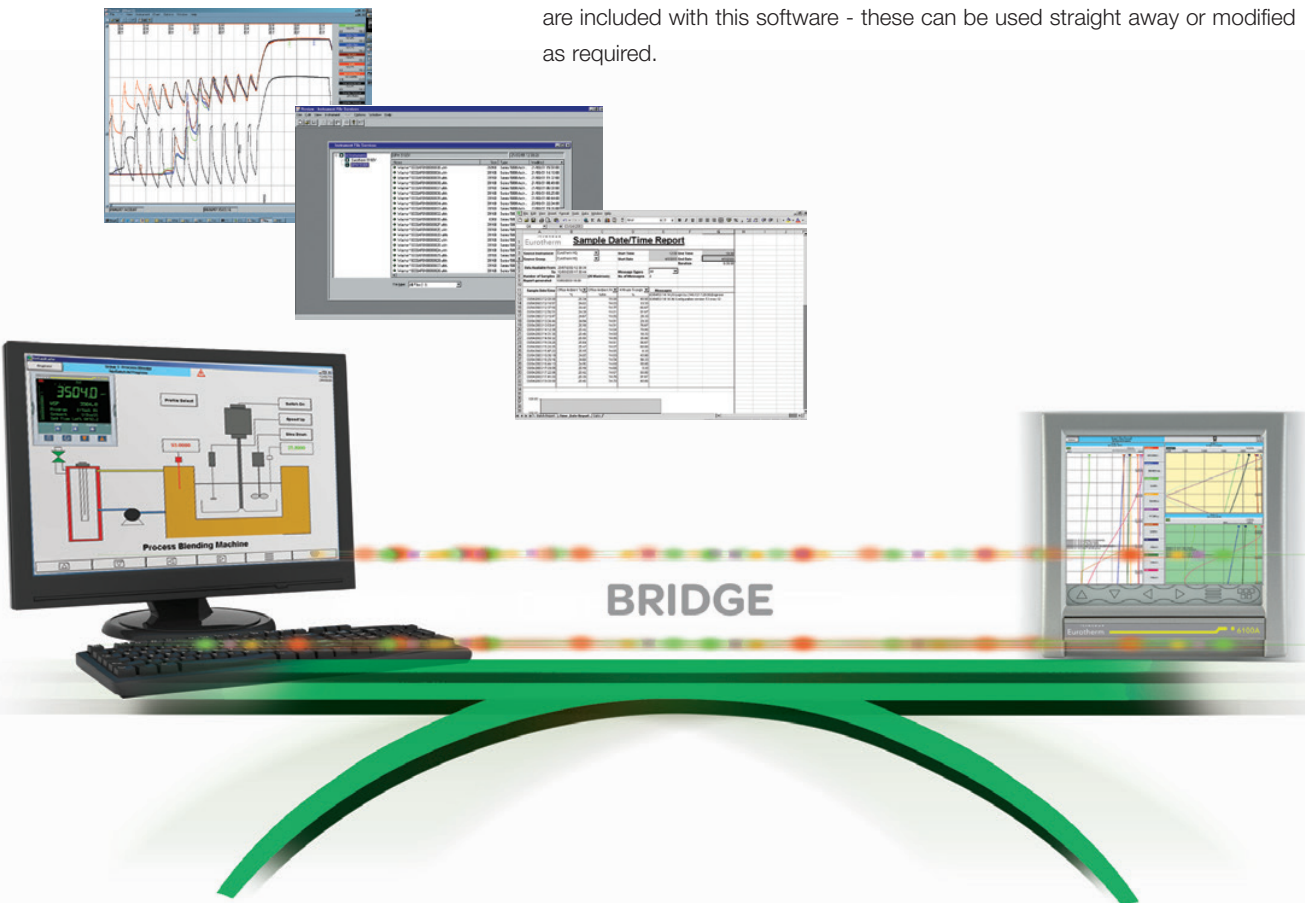

Report Software

Report is a powerful Microsoft Excel™ Add-in for use with Eurotherm secure, "UHH" files. The user can create as many templates, styles and formats as required – providing different users or departments with the exact format of the process data to best meet their needs. A number of standard templates are included with this software - these can be used straight away or modified as required.

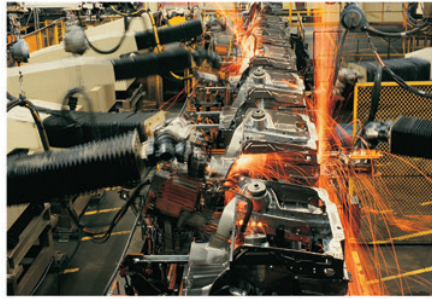

Selection guide

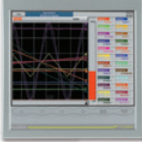

Paperless/ Graphic Recorder	     					
	6100A	6180A	6100XIO	6180XIO	6180AeroDAQ	6100E
FEATURES	18	48	×	×	48	6
Inputs	18	48	×	×	48	6
Graphic Display	5.5"	12.1"	5.5"	12.1"	12.1"	5.5"
Protection	IP66		IP66		IP66	IP66
Relay Outputs	✓		×		✓	✓
Annotation	✓		✓		✓	✓
Contact Inputs	✓		×		✓	×
Communications	Modbus TCP/RTU Master & Slave, EtherNet/IP Server					Modbus TCP Slave
Mathematics	✓		✓		✓	✓
Counters	✓		✓		✓	✓
Timers	✓		✓		✓	✓
Totalisers	✓		✓		✓	✓
PC Configuration	✓		✓		✓	✓
Ethernet/FTP	✓		✓		✓	✓
Auditor Features	✓		✓		✓	×
Batch	✓		✓		✓	×
Custom Screens	✓		✓		✓	×
Remote Viewing	✓		✓		✓	✓
Recording Speed	8Hz		8Hz		8Hz	1Hz
Trend Speed	8Hz		8Hz		8Hz	1Hz
Network Addressing	DHCP, Boot P, Fixed IP					
USB	3		1		3	1
Reports	10		10		10	×
Groups	12		12		12	1
Review of History (on screen)	✓		✓		✓	✓
AMS2750E	✓		✓		✓	×

Eurotherm USA Headquarters
44621 Guilford Drive, Suite 100
Ashburn, VA 20147
Phone: +1-703-724-7300
Fax: +1-703-724-7301
www.eurotherm.com



Scan for local
contacts

Eurotherm by Schneider Electric, the Eurotherm logo, Chessell, EurothermSuite, Mini8, Eyon, Eyris, EPower, EPack, nanodac, piccolo, versadac, optivis, Foxboro and Wonderware are trademarks of Schneider Electric, its subsidiaries and affiliates. All other brands may be trademarks of their respective owners.

All rights are strictly reserved. No part of this document may be reproduced, modified, or transmitted in any form by any means, nor may it be stored in a retrieval system other than for the purpose to act as an aid in operating the equipment to which the document relates, without the prior written permission of Eurotherm Limited.

Eurotherm Limited pursues a policy of continuous development and product improvement. The specifications in this document may therefore be changed without notice. The information in this document is given in good faith, but is intended for guidance only.

Eurotherm Limited will accept no responsibility for any losses arising from errors in this document.

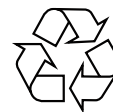

© Copyright Eurotherm Limited 2015