

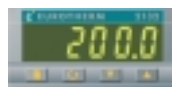

**EUROTHERM
CONTROLS**



Model 2132FM
1/32 DIN
(48 x 24mm)



Model 2116FM
1/16 DIN
(48 x 48mm)



Model 2208FM
1/8 DIN
(48 x 96mm)



Model 2204FM
1/4 DIN
(96 x 96mm)

Series 2000_{FM} Alarm Units

- Standard 1/4, 1/8, 1/16, 1/32 DIN panel cutout
- Plug-in from the front
- Independent alarm outputs
- User defined operator interface
- Digital input for alarm reset or simple front panel acknowledgment and reset of alarms
- EIA-485 communications
- IP 65 panel sealing (NEMA 4X)
- Compliant with European EMC and low voltage safety directives

The Series 2000_{FM} Family of alarm units is UL and FM approved. The family consists of four instruments; 2132_{FM}, 2116_{FM}, 2208_{FM} and 2204_{FM}.

Universal input

A universal input circuit with an advanced analog to digital convertor samples the input and continuously corrects it for drift. This gives high stability and rapid response to process changes. High noise immunity is achieved by rejection of 50/60Hz pick-up and other sources of noise. The input covers all thermocouple types, Pt100 RTD linear millivolts or milliamps or DC volts. Input filtering from 1.0 to 999.9 seconds is included.

Customized operation

Front panel LEDs provide a bright, clear display of the

process value. Tactile push buttons insure positive operation.

Access to other parameters is simple and easy to understand and can be customized to present only those parameters that need to be viewed or adjusted. All other parameters are locked away under password protection.

A digital input for alarm acknowledgement/reset is included as standard.

Alarm Operation

The alarms do not require acknowledgement during power up unless you are in an alarm condition. The alarms can only be acknowledged when the unit is out of the alarm condition. If the alarm is acknowledged before the unit is out of an alarm condition, the unit will ignore the acknowledgements.

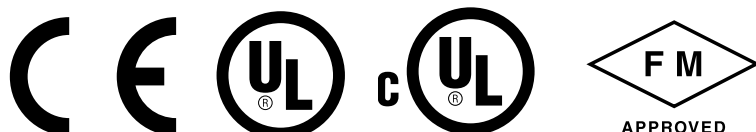

Sensor inputs and display ranges (Temperature scales conform to the ITS90 standard)

Standard Sensor Inputs	Celsius		Fahrenheit	
	Min	Max	Min	Max
J thermocouple	-210	1200	-350	2192
K thermocouple	-200	1372	-325	2500
T thermocouple	-200	400	-325	750
L thermocouple	-200	900	-325	1650
N thermocouple	-200	1300	-325	2370
C thermocouple - W5%Re/W26%Re (Hoskins)	0	2319	32	4200
R thermocouple	-50	1768	-60	3200
S thermocouple	-50	1768	-60	3200
B thermocouple	0	1820	32	3310
Platinell II thermocouple	0	1369	32	2500
RTD/PT100DIN 43760	-200	850	-325	1560
Custom Sensor Inputs (Replaces type C thermocouple)				
E thermocouple	-200	1000	-325	1830
Ni/Ni18%Mo thermocouple	0	1100	32	2012
PT10%Rh/PT140%Rh thermocouple	200	1800	392	3272
PT20%Rh/PT140%Rh thermocouple	0	2000	32	3632
W/W26%Re (Engelhard) thermocouple	0	2000	32	3632
W/W26%Re (Hoskins) thermocouple	0	2010	32	3650
W5%Re/W26%Re (Engelhard) thermocouple	10	2300	50	4172
W5%Re/W26%Re (Bucose) thermocouple	0	2000	32	3632
D thermocouple - W3%Re/W25%Re	0	2400	32	4352
Linear Inputs	-999	9999		

Dimensions

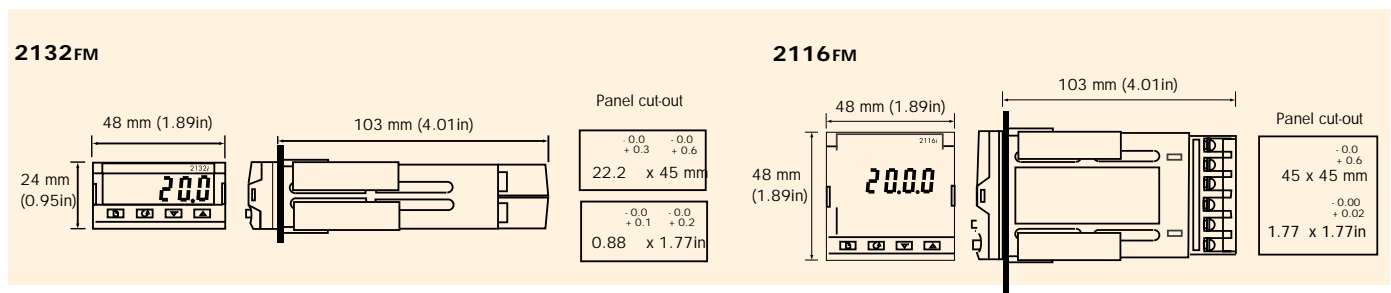

Electrical connections

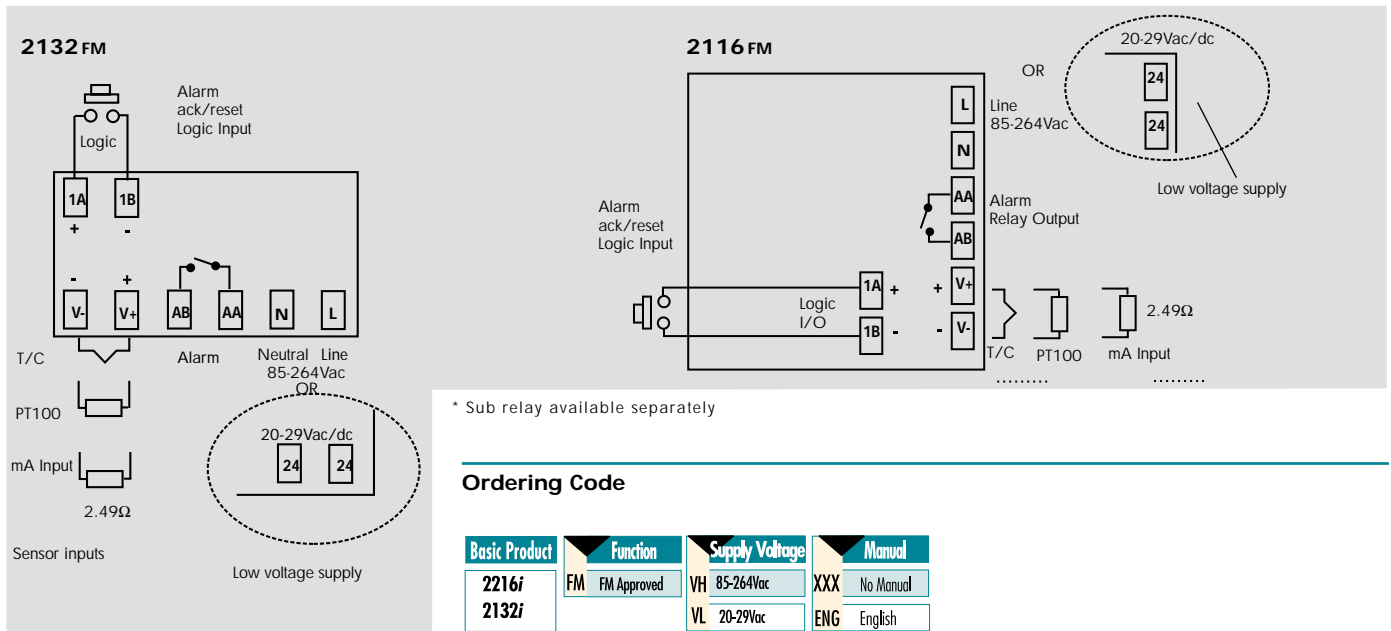

Ordering Code

Basic Product	Function	Supply Voltage	Manual
2216i	FM FM Approved	VH 85-264Vac	XXX No Manual
2132i		VL 20-29Vac	ENG English

2208 Outline Dimensions

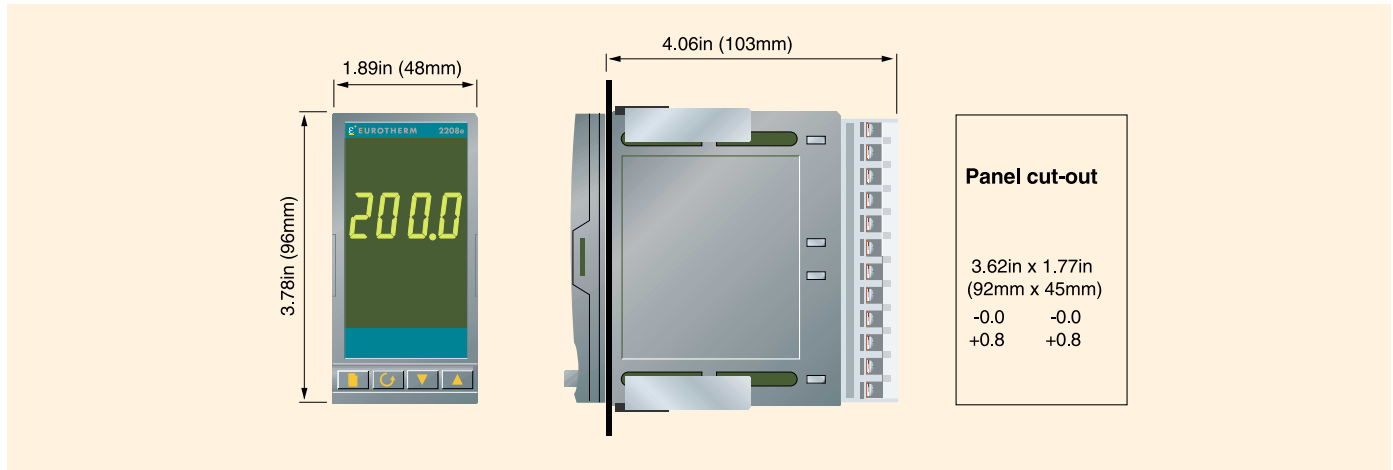

Rear Terminal Connections

Alarms 3 and 4 are optional latching and non-latching outputs which are shown in the ordering code below.

Alarm 3	Relay
1A	
1B	

Alarm 4	Relay
2A	
2B	

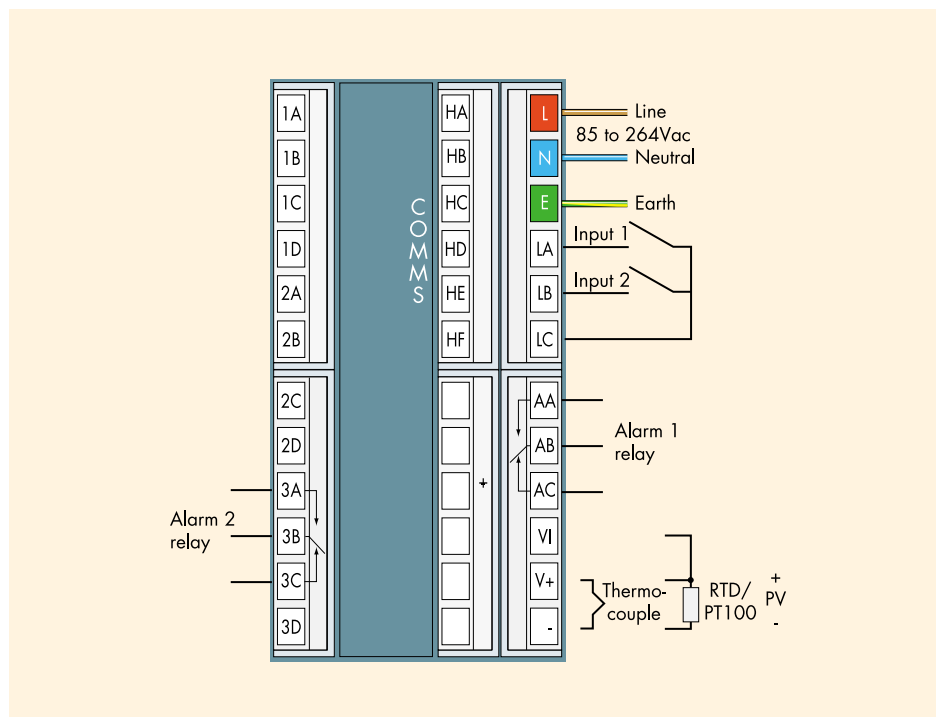

Ordering Code

Basic Product	Function	Supply Voltage	Alarm 3	Alarm 4	Alarm 1	Alarm 2	Comms	Manual	FM Approval
2208	NS Alarm	VH 85-264Vac	XX Not used RI Relay: 2-pin	XX Not used RI Relay: 2-pin	RF Relay: change over	RF Relay: change over	XX Not used YM 485 Modbus	XXX No Manual ENG English	@AU91

The above ordering code specifies only the hardware build. The input type and output control functions must then be configured on-site to suit a particular application.

2204_{FM} Outline Dimensions

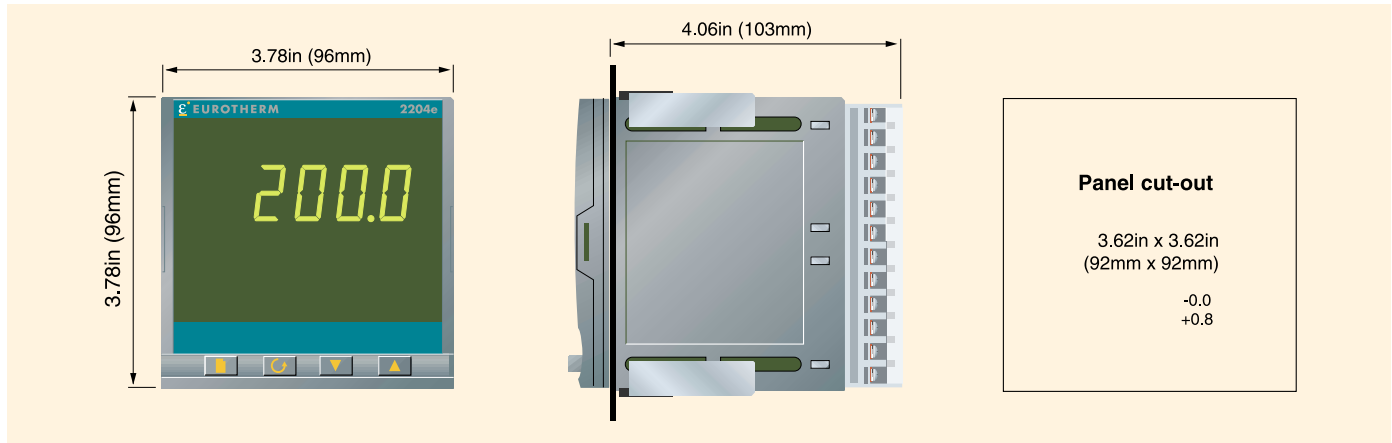

Rear Terminal Connections

Alarm 3 and 4 are optional latching and non-latching outputs which are shown in the ordering code below.

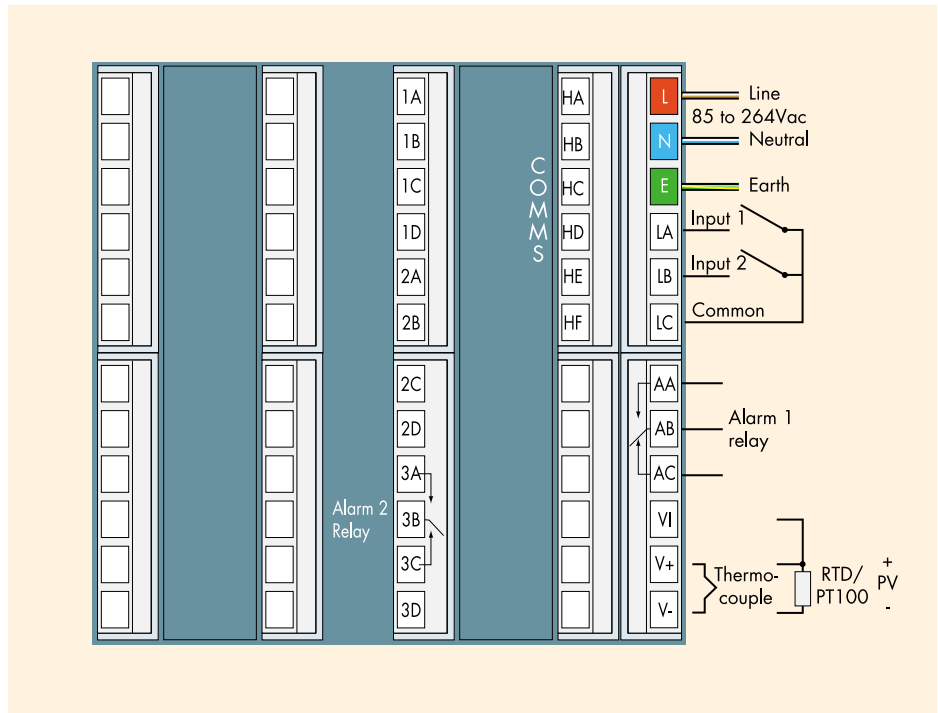
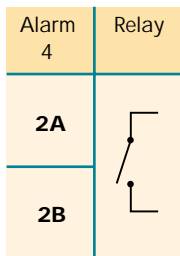
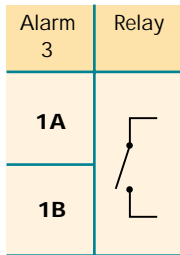

Ordering Code

Basic Product	Function	Supply Voltage	Alarm 3	Alarm 4	Alarm 1	Alarm 2	10A Relay	Comms	Manual	FM Approval
2204	NS Alarm	VH 85-264Vac	XX Not used R1 Relay: 2-pin	XX Not used R1 Relay: 2-pin	RF Relay: change over	RF Relay: change over	XX Not used	XX Not used YM 485 Modbus	XXX No Manual ENG English	@AU91

The above ordering code specifies only the hardware build. The input type and output control functions must then be configured on-site to suit a particular application. If preconfiguration is required, ask for details on the full ordering code.

EUROTHERM CONTROLS INC

11485 Sunset Hills Road
Reston, Virginia 20190-5286
Phone: 703-471-4870
Fax: 703-787-3436
Fax-On-Demand Service: 703-787-3441
www.eurotherm.com

An Invensys company

© Copyright Eurotherm Controls Inc 1999

All rights strictly reserved. No part of this document may be stored in a retrieval system, or any form or by any means without prior written permission from Eurotherm Controls Inc. Every effort has been taken to ensure the accuracy of this specification. However, in order to maintain our technological lead we are continuously improving our products which could, without notice, result in amendments or omissions to this specification. We cannot accept responsibility for damage, injury, loss or expenses resulting therefrom.

For more information contact your local representative: